



TOSHIBA

MODEL 15V31B
colour television

owner's manual



SETTING UP

For your safety

This equipment has been designed and manufactured to meet international safety standards but, like any electrical equipment, care must be taken if you are to obtain the best results and safety is to be assured. So, please read the points below for your own safety. They are of a general nature, intended to help you with all your electronic consumer products and some points may not apply to the goods you have just purchased.

Air Circulation...

Leave at least 10cm clearance around the television to allow adequate ventilation. This will prevent the TV from overheating and consequential possible damage to the TV. Dusty places should also be avoided.

Heat Damage...

Damage may occur if you leave the TV in direct sunlight or near a heater. Avoid places subject to extremely high temperatures or humidity, or locations where the temperature is likely to fall below 5°C (41 °F).

Mains Supply...

The mains supply required for this equipment is 230-240V AC 50Hz. Never connect to a DC supply or any other power source. DO ensure that the TV is not standing on the mains lead. In the UK, the fuse fitted in this plug is 5A, and is approved by ASTA or BSI to BS1362. It should only be replaced by a correctly rated and approved type and the fuse cover must be refitted. IF IN DOUBT PLEASE CONSULT A COMPETENT ELECTRICIAN.

TO FULLY DISCONNECT THE TV, SWITCH OFF THE MAINS SOCKET AND REMOVE THE POWER PLUG.

Do...

DO read the operating instructions before you attempt to use the equipment.

DO ensure that all electrical connections (including the mains plug, extension leads and inter-connections between pieces of equipment) are properly made and in accordance with the manufacturers' instructions. Switch off and withdraw the mains plug before making or changing connections.

DO consult your dealer if you are ever in doubt about the installation, operation or safety of your equipment.

DO be careful with glass panels or doors on equipment.

Do not...

DON'T remove any fixed cover as this may expose dangerous voltages.

DON'T obstruct the ventilation openings of the equipment with items such as newspapers, tablecloths, curtains, etc. Overheating will cause damage and shorten the life of the equipment.

DON'T allow electrical equipment to be exposed to dripping or splashing or objects filled with liquids, such as vases, to be placed on the equipment.

DON'T place hot objects or naked flame sources, such as lighted candles or nightlights on, or close to equipment. High temperatures can melt plastic and lead to fires.

DON'T use makeshift stands and NEVER fix legs with wood screws. To ensure complete safety, always fit the manufacturer's approved stand or legs with the fixings provided according to the instructions.

DON'T listen to headphones at high volume, as such use can permanently damage your hearing.

DON'T leave equipment switched on when it is unattended, unless it is specifically stated that it is designed for unattended operation or has a standby mode. Switch off using the switch on the equipment and make sure your family know how to do this. Special arrangements may need to be made for infirm or handicapped people.

DON'T continue to operate the equipment if you are in any doubt about it working normally, or it is damaged in any way – switch off, withdraw the mains plug and consult your dealer.

DON'T throw your old batteries into a fire, dispose of them in a designated disposal area.

ABOVE ALL – NEVER let anyone, especially children, push anything into holes, slots or any other openings in the case – this could result in a fatal electric shock.

NEVER guess or take chances with electrical equipment of any kind – it is better to be safe than sorry.



Features

- Your television has an Automatic Tuning System which makes tuning in your television easy. This Automatic Tuning System scans the entire reception range in your area and automatically stores all available channels of suitable signal strength. This will allow you to obtain the best possible sound and picture. Your television store BBC1 in channel position 1 and BBC 2 in channel position 2 etc. Channel 6 is reserved for the channel from satellite system, cable or digital terrestrial STB. Your television also has a scart connector allowing improved reception from a VCR, Satellite system, a DVD player, cable or digital terrestrial STB connections.
- The programmable on and off timer can be set to switch your television automatically. If the channel being viewed stops broadcasting, your television will switch to standby after 15 minutes.
- The remote control allows you to operate the various functions of your television (when switched on) from the comfort of your favourite viewing position.
- The on screen display allows precise remote control adjustment of brightness, contrast, colour and sharpness. When you select a channel or make other changes, your television will show an indicator on the screen for a few seconds.
- Your TV can be connected to a video cassette recorder for enhanced picture and sound quality using a SCART lead.
- Your TV allows you to access Teletext, the magazine services operated by television companies. A variety of information is available including News, Weather, Financial and Travel information. In addition to Teletext your television incorporates Fastext. Using the four coloured Fastext buttons on the remote control you may move around Teletext services with greater ease and speed.

Contents

Television and remote control	2
How to insert batteries in the remote control	3
Connecting an aerial or a VCR	4
Connecting a VCR/Satellite/Cable/Digibox using a SCART lead	5
How to tune in television stations	6
Channel Mapping	8
Manual Tuning	10
Operating your television	12
Adjusting the picture	14
On screen information	15
Setting the Panel Lock protection	16
EXT COLOUR Adjusting	17
Timer functions	18
Language selection	19
Teletext feature	20
Before requesting service please check the following points	24
Specifications	back cover





Television and remote control

The majority of buttons listed in this section have the same function as the corresponding buttons on the remote control.

Front view of your TV

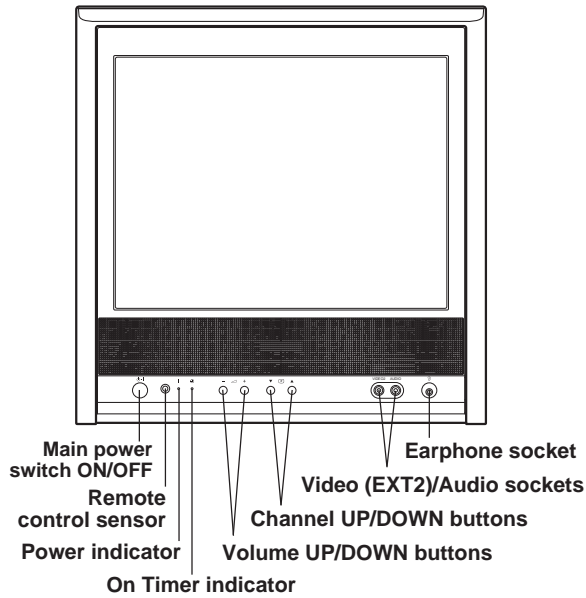

Back view of your TV

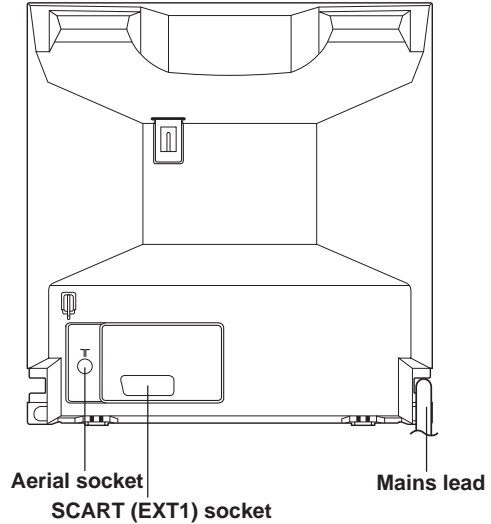

Remote Control

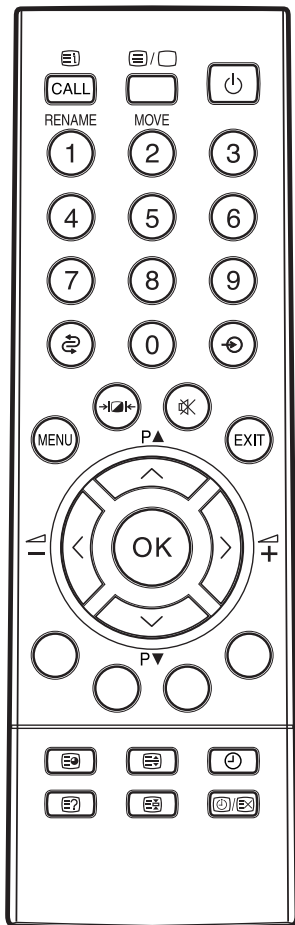

2

		Page
	Call/Text Index	15, 22
	Text/Mix/TV	20~22
	Standby	6, 12, 19
		12
	Previous	15
	Input Select	13
		7~10, 14~19
	Selectable Picture	14
	Mute	13
	Exit	6~9, 11, 14~20
	CH Up	7~12, 14, 16~19, 21
	CH Down	7~12, 14, 16~19, 21
	Volume Down	10~11, 13~14
	Volume Up	8, 10, 11, 13~14
		6~11, 14, 16~19
	Four Coloured Fasttext keys	20, 21
	Sub Page	22
	F/T/B	23
	ON/OFF Timer Set	18
	Reveal	23
	Hold	22
	Time/Text Cancel	22, 23

How to insert batteries in the remote control

Push and lift the **battery cover** on the back of the remote control. Use two UM4 / AAA / IEC R03 1.5V batteries for the remote control. Insert the batteries according to the polarity illustration inside the battery compartment. **Make sure + matches + and - matches -.**

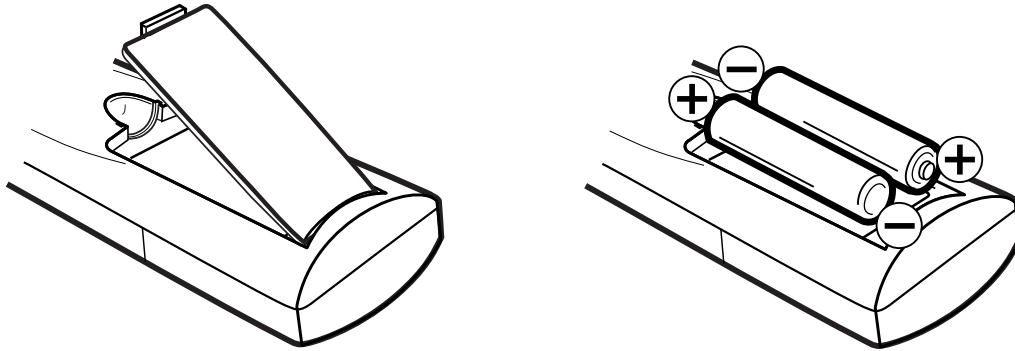

NOTES:

The batteries may last approximately one year depending on how much the remote control is used. For best performance it is recommended that batteries are replaced on a yearly basis, or when remote control operation becomes erratic.

Do not mix old and new batteries or different types. Dispose of them in a designated disposal area.

Weak batteries can leak and severely damage your remote control. Always remove batteries immediately they become weak, or if your television is not to be used for a long time.

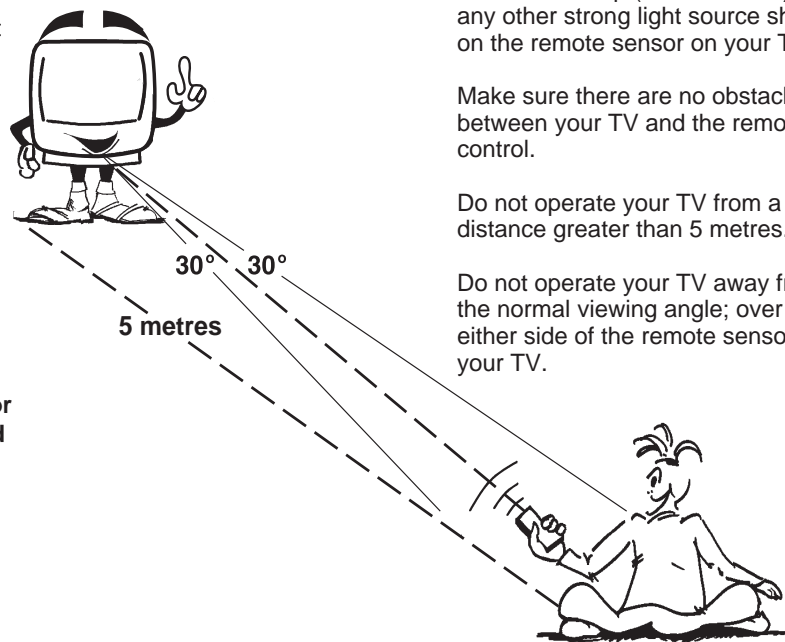

Remote control operation may become erratic if direct sunlight, fluorescent lamp, standard household lamp (incandescent) or any other strong light source shines on the remote sensor on your TV.

Make sure there are no obstacles between your TV and the remote control.

Do not operate your TV from a distance greater than 5 metres.

Do not operate your TV away from the normal viewing angle; over 30° either side of the remote sensor on your TV.



Connecting an aerial or a VCR

Your television can be tuned to receive up to 100 television broadcast stations (1-100). **Before** you can tune in these stations your television must be connected to an aerial. Using an external aerial instead of the loop aerial may improve the TV's reception.

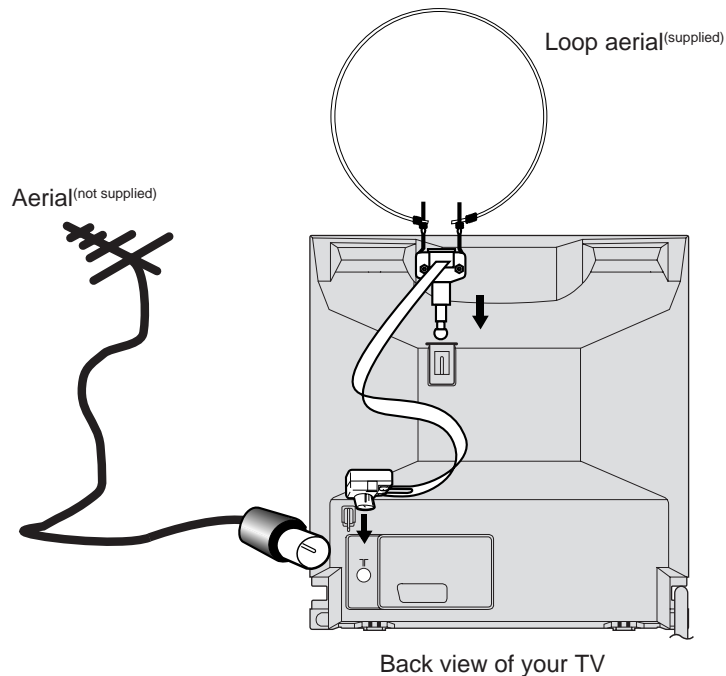

If you wish to record and playback through a VCR please follow the guidance given on this and the opposite page.

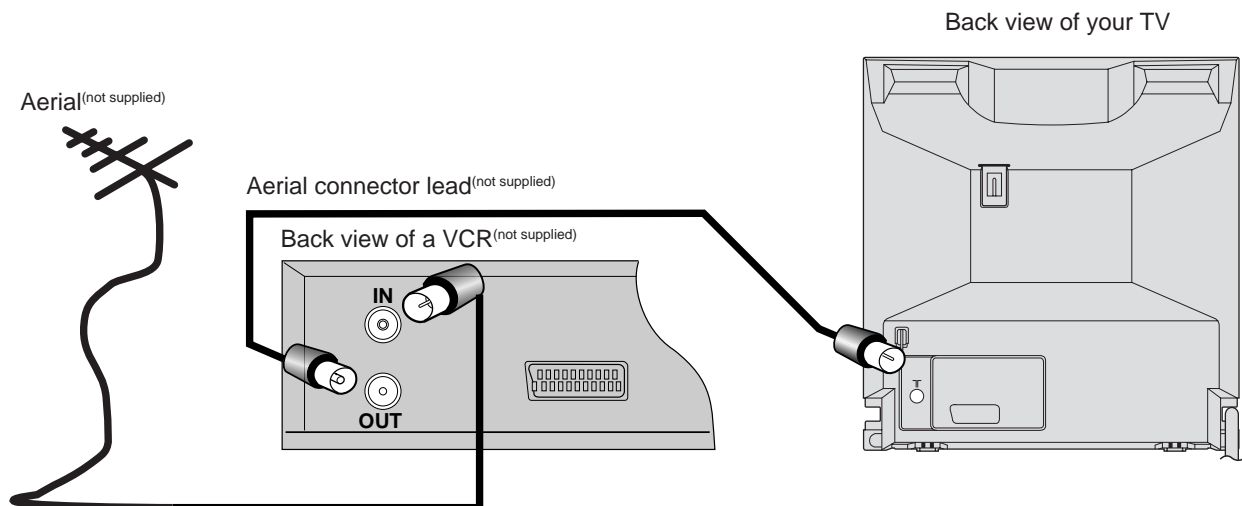

NOTES:

- All connections must be made with both your TV and VCR unplugged from the mains supply.
- The type of aerial required depends on the position of your home, it's distance from the transmitter and local interference. If you do not have an aerial and you are uncertain of what to buy, you should seek the advice of a local aerial contractor.

4

Connecting a VCR/Satellite/Cable/Digibox using a SCART lead

By using a **SCART lead** you can improve the quality of playback. Remember you must still have the "normal" **aerial connector** connected as shown on the opposite page. If you are using a **SCART lead** you should not have to tune your TV to your VCR; instead select the appropriate EXT input by repeatedly pressing the  (INPUT SELECT) button on the remote control until you see the signal from the VCR.

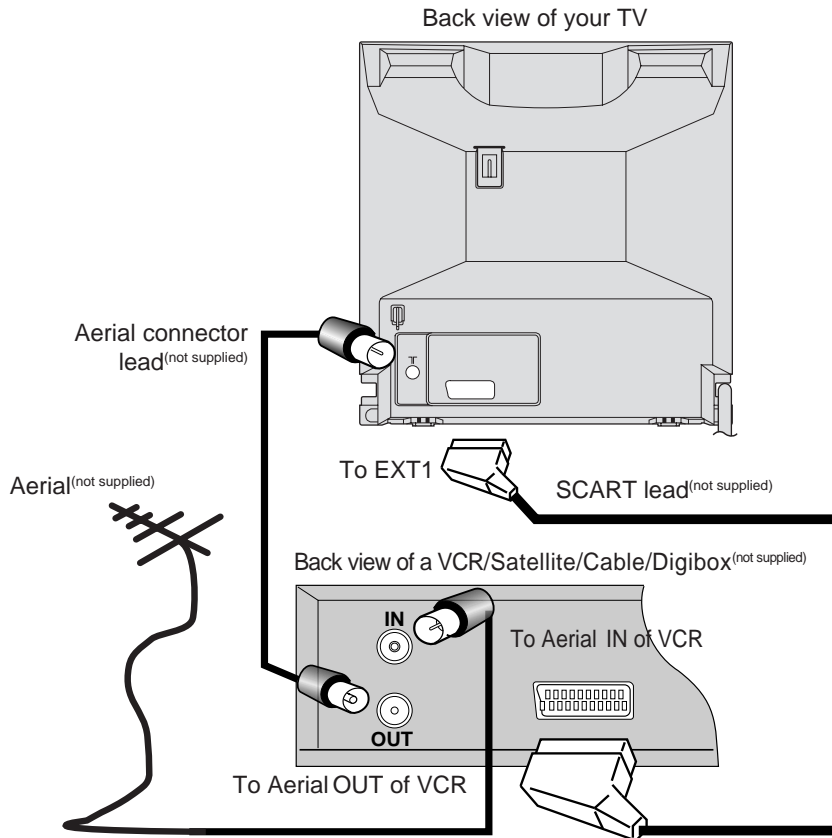

NOTES:

- All connections must be made with both your TV and VCR unplugged from the mains supply.
- The type of aerial required depends on the position of your home, it's distance from the transmitter and local interference. If you do not have an aerial and you are uncertain of what to buy, you should seek the advice of a local aerial contractor.



How to tune in television stations

Your television has an Automatic Tuning System which makes tuning in your television easy. This Automatic Tuning System scans the entire reception range in your area and automatically stores all available channels of suitable signal strength in the correct order e.g. BBC1 will tune into channel 1, BBC2 will tune into channel 2, etc.



NOTES:

- **ONLY WHEN YOU TURN ON THIS SET FOR THE FIRST TIME, THE AUTOMATIC TUNING PROCESS WILL START AUTOMATICALLY.**
- Please refer to your Satellite instruction book to see how to select Sky One.

Before you can view a television station it must be stored in your television memory, this section will show you how to achieve this. You cannot tune TV channels if the aerial is not connected to the aerial socket of your television.

- 1 Make sure that your TV is properly installed.

Press (main power) switch on the front panel, the red standby indicator will light.

Switch on your television by pressing (standby) on the remote control.

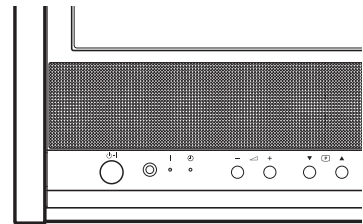

- 2 If you have a VCR connected make sure that it is switched on and it's test pattern is switched on **or** a video is playing . . . you will be unable to see anything at the moment!

If you have a Satellite system connected make sure that it is switched on and you have selected Sky One. . . you will be unable to see anything at the moment!

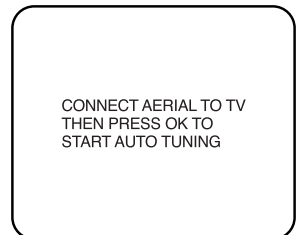

Press **OK** on your remote control!
Your TV will now automatically tune in all available channels.

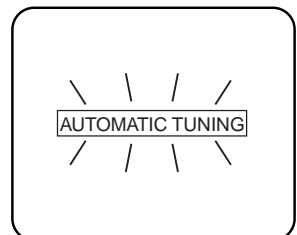

- 3 When the programme on the screen stops changing and the sound comes on, the tuning process is complete.

Press **EXIT** to clear the CHANNEL MAPPING menu display.

CHANNEL MAPPING		
1	BBC1	11
2	BBC2	12
3	ITV	13
4	CH4	14
5	CH5	15
6	SAT1	
	7	

PRESS: / RENAME / MOVE / MENU / EXIT

Your TV is now tuned in and ready to watch...
If you wish to change the order that the stations are stored in, refer to the Channel Mapping section in this book.





How to tune in television stations



- 1 Press **MENU** on your remote control. The on screen display will appear.
Press **P ▲** or **P ▼** on your remote control to select **SETUP** menu.

- When you plug the AC mains lead in for the first time, the **Language** menu will appear instead of the main control menu. Select the language required.



- 2 Press **OK** to confirm. The **SETUP** on screen display will appear.
Press **P ▲** or **P ▼** to select **AUTOMATIC TUNING**.

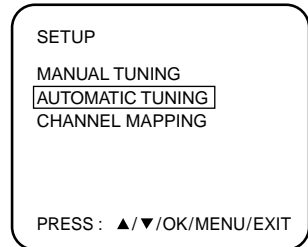

- 3 Press **OK** to confirm. This will start the **automatic tuning process**.
• This process will take a few minutes to complete ... please be patient.

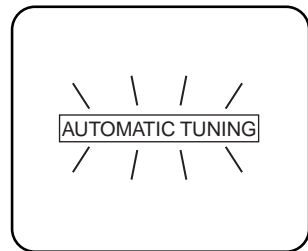

- 4 When the programme on the screen stops changing and the sound comes on, the tuning process is complete.

Press **EXIT** to clear the CHANNEL MAPPING menu display.

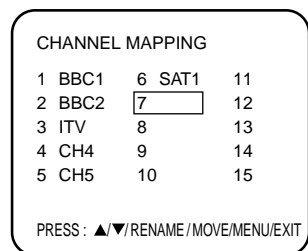

NOTE:

Your TV stations, Video (if connected) and Satellite (if connected) should be tuned in the following order:

BBC 1	channel 1
BBC2	channel 2
ITV	channel 3
CHANNEL 4	channel 4
CHANNEL 5	channel 5 (if receivable)
SATELLITE	channel 6
VCR	channel 7

Your VCR will be stored in a channel position if connected with an aerial lead to the TV. If it is connected by just a SCART lead your VCR can be viewed by pressing .

Your TV is now tuned in and ready to watch ... If any stations have been missed refer to the Manual Tuning section in this book.



Channel Mapping

Broadcast names can be changed or added by using the Channel Mapping menu below.



TO CHANGE A BROADCAST NAME

- 1 Press **MENU** on your remote control. The on screen display will appear.

Then press **P▲** or **P▼** to select **SETUP** menu. Press **OK** to confirm.

ON/OFF TIMER
SETUP
 PICTURE
 EXT COLOUR AUTO
 LANGUAGE
 PANEL LOCK ON **OFF**

PRESS: ▲/▼/OK/MENU/EXIT

- 2 Press **P▲** or **P▼** to select **CHANNEL MAPPING** menu. Press **OK** to confirm.

SETUP
 MANUAL TUNING
 AUTOMATIC TUNING
CHANNEL MAPPING

PRESS: ▲/▼/OK/MENU/EXIT

- 3 Press **P▲** or **P▼** to select the TV section to be named. Press the number "1" to rename a broadcast. The **CHANGE BROADCAST NAME** menu will appear.

CHANNEL MAPPING

1 BBC1	6 SAT1	11
2 BBC2	7	12
3 ITV	8	13
4 CH4	9	14
5 CH5	10	15

PRESS: ▲/▼/RENAME/MOVE/MENU/EXIT

- 4 Press **P▲** or **P▼** to name the desired letter, then press **▲ +** to store. Repeat these steps for the next character, then press **OK**.

The display changes as follows:

CHANGE BROADCAST NAME

1 BBC1	6 SAT1	11
2 BBC2	7 A	12
3 ITV	8	13
4 CH4	9	14
5 CH5	10	15

PRESS: ▲/▼/+/-/OK/MENU/EXIT

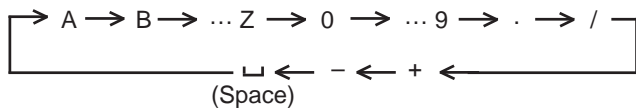

Repeat the step 3 and 4 for other TV stations. Press **EXIT** to remove the menu from the screen.



In some cases, your channels will not tune in the correct order. In this case you may wish to move the position of one of the stations.

TO MOVE THE TV STATION TO ANOTHER CHANNEL POSITION

Example: Move the TV station from position 8 to position 9.



- 1 Press **MENU** on your remote control. The on screen display will appear.

ON/OFF TIMER
SETUP
 PICTURE
 EXT COLOUR AUTO
 LANGUAGE
 PANEL LOCK ON **OFF**

PRESS: ▲/▼/OK/MENU/EXIT

Then press **P▲** or **P▼** to select **SETUP** menu. Press **OK** to confirm.

- 2 Press **P▲** or **P▼** to select **CHANNEL MAPPING** menu. Press **OK** to confirm.

SETUP
 MANUAL TUNING
 AUTOMATIC TUNING
CHANNEL MAPPING

PRESS: ▲/▼/OK/MENU/EXIT

- 3 Press **P▲** or **P▼** to select the TV station to be moved.

CHANNEL MAPPING

1	BBC1	6	SAT1	11
2	BBC2	7		12
3	ITV	8		13
4	CH4	9		14
5	CH5	10		15

PRESS: ▲/▼/RENAME/MOVE/MENU/EXIT

- 4 Press the number "2" to move a broadcast. The **MOVE CHANNEL** menu will appear.

MOVE CHANNEL

1	BBC1	6	SAT1	11
2	BBC2	7		12
3	ITV	8		13
4	CH4	9		14
5	CH5	10		15

PRESS: ▲/▼/OK/MENU/EXIT

- 5 Press **P▲** or **P▼** to select the position number to which the selected TV station is to be moved. Then press **OK** to store.

MOVE CHANNEL

1	BBC1	6	SAT1	11
2	BBC2	7		12
3	ITV	8		13
4	CH4	9		14
5	CH5	10		15

PRESS: ▲/▼/OK/MENU/EXIT

Repeat the step 3 to 5 for other TV stations.

Press **EXIT** to remove the menu from the screen.

Manual Tuning

In certain areas of the countries which have poor reception the Automatic Tuning System may not tune your television to the strongest broadcast signal. If you are not satisfied with the automatic tuning you may manually tune your television to obtain the best possible picture and sound.



- 1 Select your TV channel to select your required channel number for tuning by pressing **P▲** or **P▼**.

Press **MENU** on your remote control.

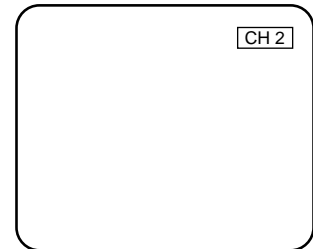

- 2 Press **P▲** or **P▼** to select **SETUP** menu. Press **OK** to confirm.

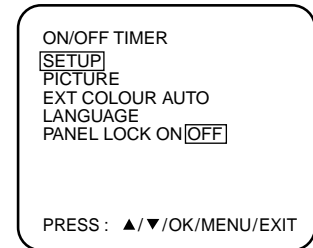

- 3 Press **P▲** or **P▼** to select **MANUAL TUNING**. Press **OK** to confirm.

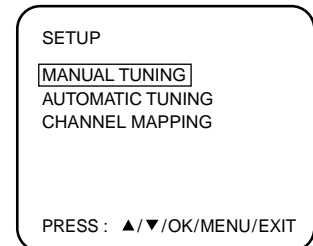

- 4 Press **▲ +** to search up the waveband or **▼ -** to search down the waveband.

Each time a station is found the search will stop.

- If you need to make the picture clearer, press **P▲** or **P▼** for Fine Tuning.
- Press **▲ +** or **▼ -** to continue searching until the station you want is found.

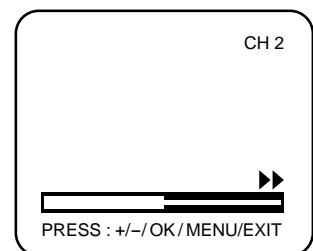



Manual Tuning

5 Press **OK** to store the station you selected.

Press **P▲** or **P▼** to select your required channel position number (1~100).

Press **OK** to store the channel number.

- Use the channel guide on page 7 for guidance.

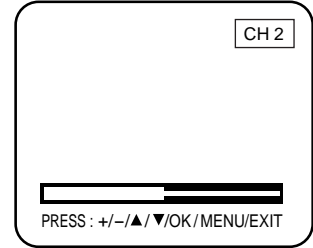



6 Repeat stages 4 - 5 for tuning other channels.

Press **EXIT** to remove the tuning menu from the screen.





TO SKIP A CHANNEL:

If at a later date you wish to skip an unwanted channel when using **P▲** or **P▼**, select the channel and press  or  on the remote control at stage 5.

- The channel number will flash when skip is selected for that channel.

To cancel the skip function, select the channel and press

 or  at stage 5. The channel number will cease to flash.

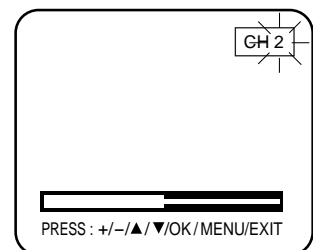

Operating your television

The next two pages detail how to use your TV's basic features; standby, changing channel, and adjusting the volume.



1 Press **⏻** (**main power**) switch on the front panel, the red indicator will light.

Switch on your television by pressing **⏻** (**standby**) on the remote control.

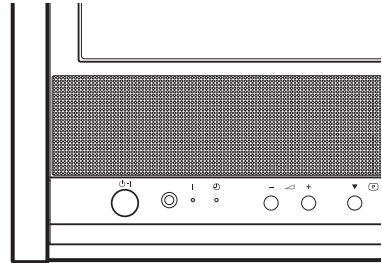

2 To set your TV into **standby** mode, press **⏻** (**standby**) on the remote control.

The **⏻** (**standby**) button on the remote control doesn't switch the set off completely it only switches it to standby mode. To turn your television off completely, switch off **⏻** (**main power**) on the front panel and unplug the television at the wall socket.

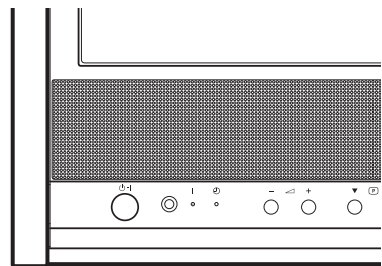

3 Press the **numbered buttons** to select channels. When selecting channels, press two numbered buttons. For example, for **channel 3** press **3**, for **channel 25** press **2** then **5**. Press **P▲** or **P▼** to select channels in sequence; e.g. 1, 2, 3, 4 etc.

- When a channel is selected the channel number is displayed in the top right corner of the screen.

Use the **⏻ (**standby**) button on the remote control to switch the TV on from standby mode.**



Operating your television



- 1** If you have a **VCR, Satellite Receiver, DVD player** or **Games Console** you may connect them to your **TV** with a **SCART lead**.

To view equipment connected to your **TV** with a **SCART lead** press (**INPUT SELECT**) until **EXT1** or **EXT2** appears on your screen.

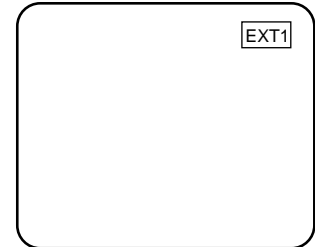

To view TV channels again press (**INPUT SELECT**) until a numbered TV channel appears.

- 2** Press to adjust the sound level.

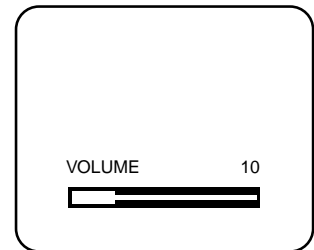

- 3** Press (**Mute**) to switch off the sound.
- When the sound is switched off **SOUND MUTE** will appear on screen.

Press (**Mute**) a second time or press to switch the sound back on.

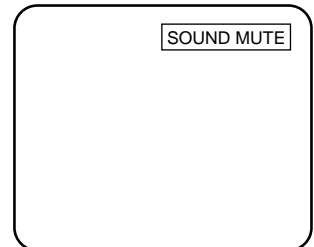



Adjusting the picture

The picture settings have been adjusted by the factory under optimum signal reception conditions, however conditions may not be the same in your area. After turning on your television, allow it to warm up for a few minutes before making any adjustments.

If the picture is not to your liking, make the following adjustments using the remote control.



1 Press **MENU** on your remote control. The on screen display will appear.



2 Press **P▲** or **P▼** to select **PICTURE** menu.

Press **OK** to select adjustment screens.

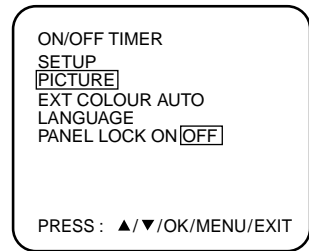

3 Press **P▲** to view BRIGHTNESS, CONTRAST, COLOUR or SHARPNESS on screen displays. (Tint menu will be displayed when an NTSC signal is input on SCART.)

Press **▲ +/-** to adjust the levels.

- Pictures appear sharpest in the daytime by increasing the contrast. In the evening (when surroundings are darker) the sharpest picture can be obtained by reducing the contrast.

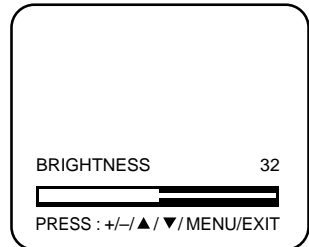

4 Press **EXIT** to remove the picture menu from the screen.

- If you do not make an adjustment within 1 minute the menu will disappear.



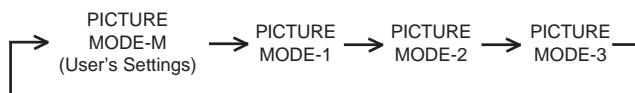

NOTE : Should you wish to reset picture controls to factory settings (MODE-1/MODE-2/MODE-3), press **→|◀|←** to select your preferable picture contrast.

PICTURE ADJUSTMENT : Your preferable picture contrast can be selected by pressing **→|◀|←** (Selectable Picture) button repeatedly.



On screen information

The screen call function lets you see at a glance which channel is currently selected.

- 1 Press **CALL**  on the remote control; the TV screen will display the current channel.
- 2 Press **CALL**  a second time to disappear the channel.
 - The channel number using the call display will not disappear unless you press **CALL**  again.

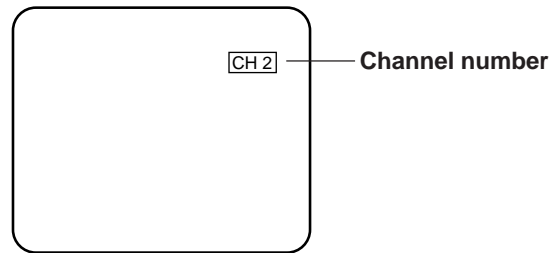

Previous programme function:

- The  button allows you to go back to the previous channel selected by just pressing this button. Press this button again to return to the channel you were watching.



Setting the Panel Lock protection

If you set the Panel Lock to ON in the menu, nobody will be able to operate the Volume and Channel changes on the front button of your TV. (The word "PANEL LOCK" will flash on the screen when pressing P▲/P▼ or ▲ + / - button.)



- 1 Press **MENU** on your remote control. The on screen display will appear.

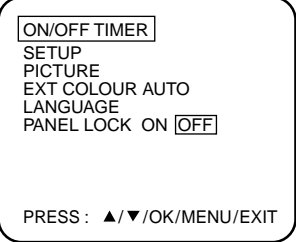

- 2 Press **P▲** or **P▼** to select **PANEL LOCK ON/OFF** menu.

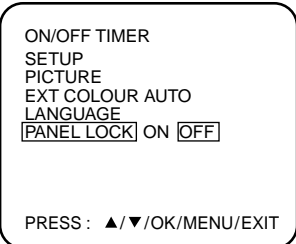

- 3 Press **OK** to select **ON** or **OFF**.

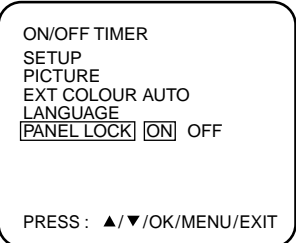

- 4 Press **EXIT** to remove the menu from the screen.



EXT COLOUR Adjusting

When connecting external equipment to the TV, the picture may become black and white. This can be corrected by selecting Extension Colour as follows.



- 1 Press **MENU** on your remote control. The on screen display will appear.
Press **P▲** or **P▼** to select the EXT COLOUR menu.

ON/OFF TIMER
 SETUP
 PICTURE
 EXT COLOUR | AUTO
 LANGUAGE
 PANEL LOCK ON | OFF

PRESS : ▲/▼/OK/MENU/EXIT

- 2 Press **OK** to select one of the colour options, AUTO/PAL/NTSC 4.43/NTSC 3.58.

- Usually select the AUTO option.

- 3 Press **EXIT** to remove the menu from the screen.

Timer functions

The on timer feature allows you to automatically turn on your TV after a preset amount of time (up to 12 hours and 59 minutes) at the selected channel.

The off timer also allows you to turn off your TV after a preset amount of time. You can set the off timer in conjunction with the on timer.



NOTE:

ON/OFF TIMER menu (step 2) can be also accessed by pressing the button while watching the TV.

1 Press **MENU** on your remote control. The on screen display will appear.

Press **P▲** or **P▼** to select ON/OFF TIMER menu.

Press **OK**.

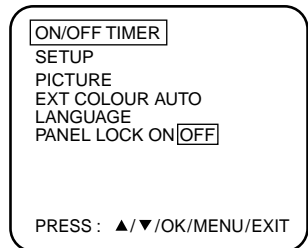

2 Press **P▲** or **P▼** to select ON TIMER menu.

Press **OK**.

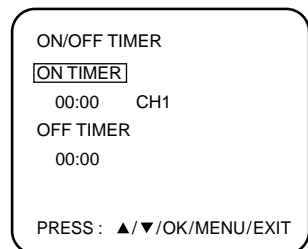

3 Press **P▲** to enter the hours and minutes at which you want your TV to automatically switch on.

- For rapid time change in ten minute intervals, press and hold the **P▲** button.

Press **OK**.



4 Press **P▲** or **P▼** to select the channel you wish to display when you TV switches on.

Press **OK** and press **EXIT**.

The yellow ON TIMER indicator will light.

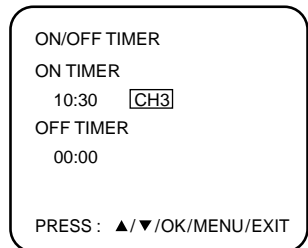

If you wish to set the OFF TIMER, press **P▲** or **P▼** to select OFF TIMER at step 2.

Put your TV into standby mode by pressing (standby) button on the remote control. **DO NOT** turn off the TV using the (main power) switch on the front panel.



Language selection

This feature allows you to select the language you wish your TV on screen display to appear in.



1 Make sure that your TV is properly installed.

Switch on your TV using the (main power) switch on the front panel, then press (standby) on the remote control.

2 Press **MENU**. The main control menu will appear on your TV screen.

Press **P▲** or **P▼** to select **LANGUAGE** menu.
Press **OK** to select **LANGUAGE** screen.

- Only when you plug the AC mains lead for the first time, the main control menu will be skipped and move to the language screen. This is not a fault, please select desired language at first.



3 Press **P▲** or **P▼** to select desired language.

Press **OK** to store your setting.

Press **EXIT** to clear the screen.



Teletext feature



Teletext is the name given to the magazine services operated by television companies.

A variety of information is available including News, Weather, Financial and Travel information. Teletext is normally transmitted whenever a station is on air. In addition to Teletext your television also incorporates Fastext. Using the **four coloured Fastext** keys you may move around Teletext services with greater ease and speed.

- 1 To view Teletext press (text/mix/tv).

- 1st pressText only.
- 2nd pressText and TV picture.
- 3rd pressTV picture only.



- 2 An index page will be displayed. The top and bottom lines of the page may look like this example:

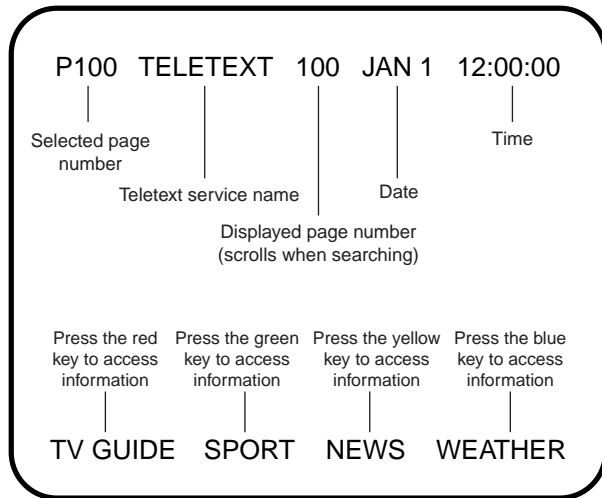

Teletext also has **SUBTITLES** available for many programmes. Consult your TV guide for more details.



Teletext feature

In order to use Teletext the control codes must be transmitted by the broadcasting authorities - its operation is, therefore dependent on these codes being transmitted.



- 1** To view Teletext press  (text/mix/tv).

1st pressText only.
2nd pressText and TV picture.
3rd pressTV picture only.

To return to normal TV press  (text/mix/tv).



- 2** All Teletext pages are three digit numbers e.g. to select page 100, press **1**, then **0**, then **0**.

If you accidentally press a wrong button, complete the sequence with any three numbers, then re-enter the correct number.

Press **P▲ (Page)** or **P▼ (Page)** to advance pages sequentially up or down.

- Using the **four coloured Fastext** keys you may move around Teletext services with greater ease and speed.



- 3** To switch from one Teletext service to another press  (text/mix/tv) until the TV picture is displayed.

Select another TV channel.

Press  (text/mix/tv) to revert to Teletext.



Teletext feature

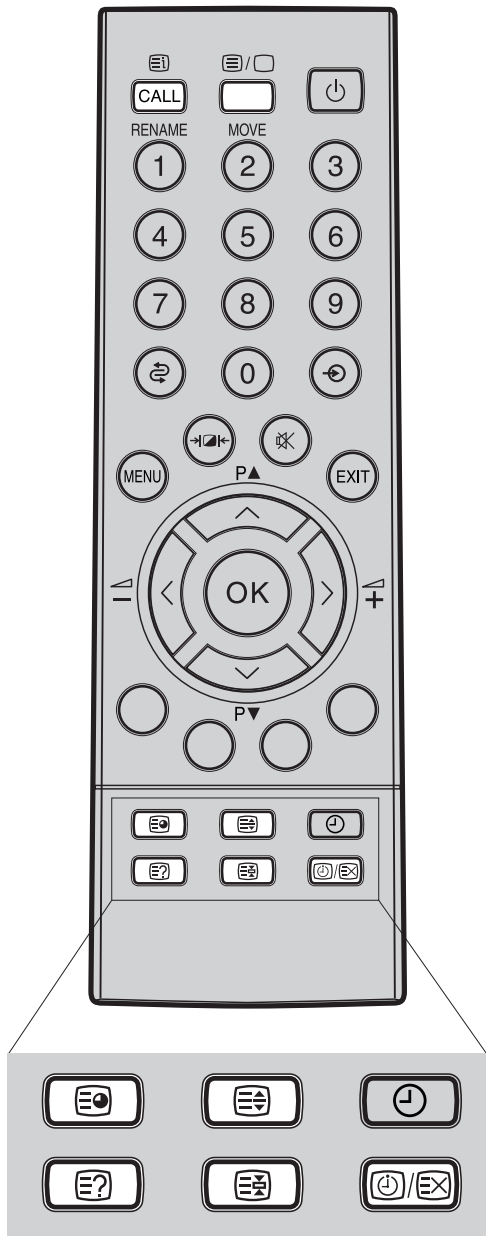

Some Teletext pages contain too much information to be displayed on a single page, when this occurs sub-pages are transmitted. Sub-pages are identified by an additional numbering sequence, e.g. 1/3, where the first number indicates the sub-page number and the second indicates the number of available sub-pages.

- Press **Hold** to freeze a page.

 - The hold symbol will appear in the top left corner of the screen.

Press **Hold** a second time to release page.

 - Pages and sub-pages are transmitted in sequence with an adequate pause for reading each page. You may freeze a page which is of particular interest and hold it on screen. Information **cannot** be updated when page/sub-page is held using **hold**.
 - Also, you will miss any sub-pages which are broadcast while using the **Hold** function is being used.



- Press **sub page** to view a sub-page. 4 dashes will appear; if you do not enter any numbers they may only be removed by pressing **sub page**. Select the desired sub-page number, e.g. sub page number 2 press **0 0 0 2** by pressing the direct channel entry buttons.

 - Whilst using subpages it is essential to enter four numbers. The current sub page will stay on the screen until your chosen one has been broadcast. Your sub page will stay on the screen and, as information is received from the transmitter, the screen will be updated, e.g. a page of share prices. Press **CALL** **Index** to return to the INDEX page.

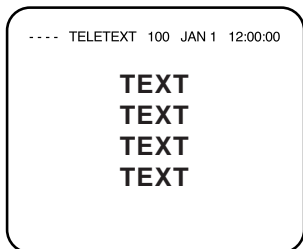

- When viewing in normal TV mode, press **Time/Text Cancel** to display the current time (via teletext).

 - The current teletext region and service will also be displayed.





Teletext feature

In order to use Teletext the control codes must be transmitted by the broadcasting authorities - it's operation is, therefore dependent on these codes being transmitted.

1 Press  (**F/T/B**) to increase the size of the characters on screen.

1st press View the top of the page.

2nd press View the bottom of the page.

3rd press Return to full view of full page (text normal size).

P100 TELETEXT 100 JAN 1 12:00:00

**TEXT
TEXT
TEXT**

2 Press  (**Time/Text Cancel**) then enter your page number.

This function enables the TV picture to be viewed whilst a selected page is being located. Once found the page number will be displayed in the top left of the TV picture.

Press  (**text/mix/tv**) to view the selected page.

101







3 Press  (**Reveal**) to display hidden text.

Some pages contain hidden text, e.g. a quiz page with concealed answers.



Before requesting service please check the following points

Symptom	Cause	Solution
No standby light.	Is your TV plugged in?	Plug your TV into mains socket (AC outlet).
	Is the main power switch on the front of your TV off?	Press  (main power) switch.
	Has the fuse in the mains plug blown?	Replace fuse in mains plug.
No picture, no sound.	Is your TV plugged in?	Plug your TV into mains socket (AC outlet).
	Is the aerial connection cable broken or damaged?	Check all aerial connections for broken or damaged wires. If necessary replace with new cables.
	Possibly station trouble.	Try other stations to see if they are stronger or move the aerial away from possible source of interference. If you live in a known poor reception area try using an aerial booster to improve the quality of broadcast signal.
	Is the main power switch on the front of your TV off?	Press  (main power) switch.
	Have you pressed the  (Mute) button or have you set the volume at minimum?	Press the  (Mute) button again or increase the volume using the  control.
Unable to select channel numbers 8 through to 100.	During automatic tuning your television didn't find enough channels to place in these numbered positions?	If a television station has been missed try repeating the automatic tuning operation as described on page 7.





Symptom	Cause	Solution
Poor or no colour.	Aerial or connection cable may not be connected or cable is damaged or broken?	Check all aerial connections for broken or damaged wires. If necessary replace with new leads.
	Colour control is not adjusted?	Adjust colour.
No teletext or strange character letters on screen.	Aerial connection is poor or possibly station trouble?	Check all aerial connections for broken wires or try another channel.
	Good performance of text depends on a good strong broadcast signal.	This may require the use of a roof or loft aerial.
Remote control does not work or operates erratically.	Weak or exhausted batteries.	Replace batteries.
	Batteries placed in the wrong way round?	Place the batteries correctly.
Unable to playback video tapes.	During automatic tuning you didn't have your VCR switched on, therefore your television was unable to find the VCR channel?	Before starting the automatic tuning operation, make sure you have your VCR switched on displaying it's test signal.





Specifications

Television

Picture tube	15" (35.7 cm visible screen) measured diagonally 90 degrees deflection
Colour system	PAL
Front Video Input	RCA
Front Audio Input	RCA
Other Terminal	Earphone
External antenna	75 Ohm DIN type
SCART socket	21 PIN
Speaker	1.5"x2.7" Permanent magnet dynamic speaker
Normal Impedance	8 ohms
Sound output	5.0 W

General

Mains supply	AC 230-240 V 50 Hz
Power consumption	46 W (3 W in standby)
Operating temperature	5°C ~ 40°C
Dimensions	366(W) x 396.7(D) x 373(H)
Weight	11.0 kg (without accessories)
Accessories	Remote control Remote control batteries (2 x UM-4 / AAA / IEC R03 1.5 V) Loop aerial

Weight and Dimensions are approximate. Because we continually strive to improve our products we may change specifications and designs without prior notice.

EXCLUSION CLAUSE

Toshiba shall under no circumstances be liable for loss and/or damage to the product caused by:

- i) fire;
- ii) earthquake;
- iii) accidental damage;
- iv) intentional misuse of the product;
- v) use of the product in improper conditions;
- vi) loss and/or damage caused to the product whilst in the possession of a third party;
- vii) any damage or loss caused as a result of the owner's failure and/or neglect to follow the instructions set out in the owner's manual;
- viii) any loss or damage caused directly as a result of misuse or malfunction of the product when used simultaneously with associated equipment;

Furthermore, under no circumstances shall Toshiba be liable for any consequential loss and/or damage including but not limited to the following, loss of profit, interruption of business, the loss of recorded data whether caused during normal operation or misuse of the product.

WARNING! NEVER LEAVE A STATIONARY IMAGE ON THE SCREEN

If stationary images generated by TELETEXT, CHANNEL IDENTIFICATION LOGOS, COMPUTER DISPLAYS, VIDEO GAMES, ON SCREEN MENUS, etc. are left on the TV screen for any length of time, they could become permanently ingrained.

If you use your television to display completely still images, or moving pictures which have a permanent still image superimposed e.g. broadcast network logos, it is always advisable to reduce BOTH the brightness and contrast settings.



J3N70401A

'03.09

CARE and disposal

Cleaning the screen and cabinet...

Turn off the power, clean the screen and cabinet with a soft, dry cloth. We recommend that you **do not** use any proprietary polishes or solvents on the screen or cabinet as this may cause damage.

Disposal...

When the set reaches the end of its useful life please dispose of it in accordance with Local Government Regulations or at a recycling centre.

QUICK SET-UP GUIDE

TOSHIBA

MODEL - 15V31B

1. CONNECTIONS

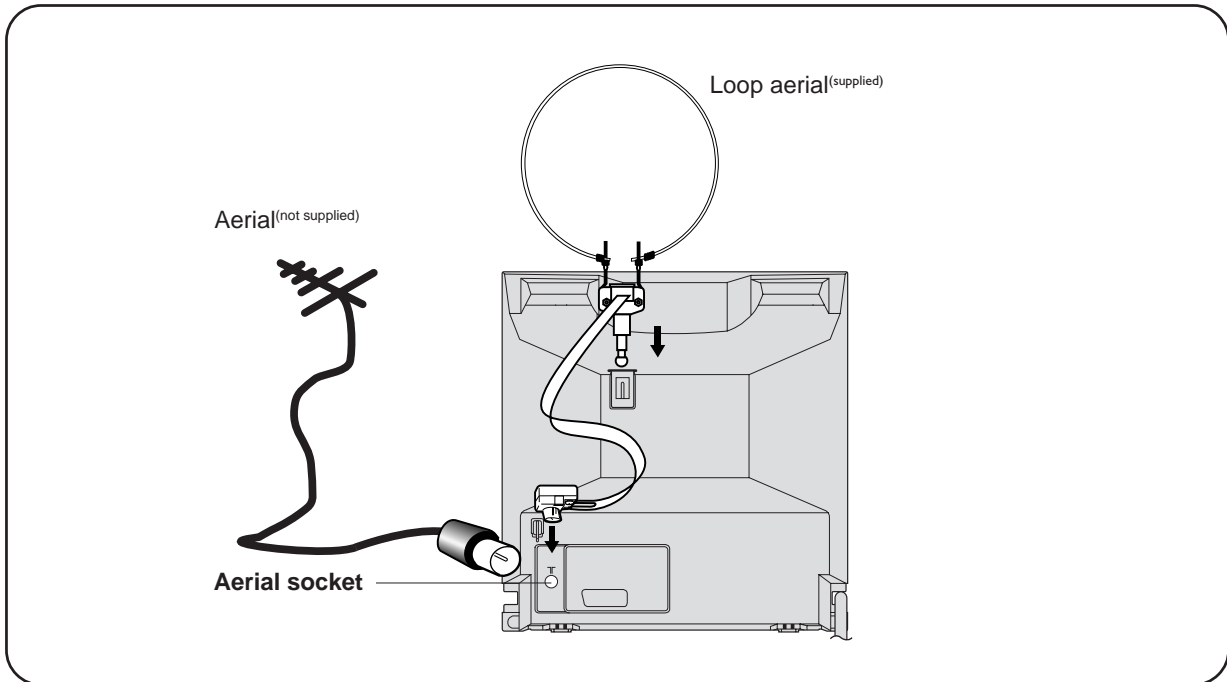

2. INSTALLING BATTERIES

1. Open the cover and remove.

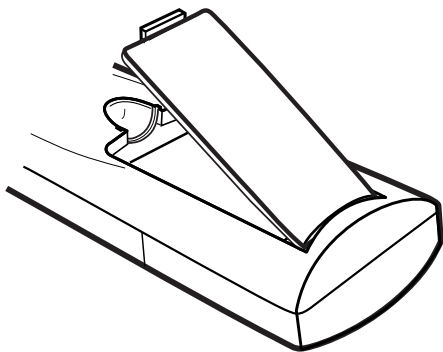

2. Insert two batteries as shown below.

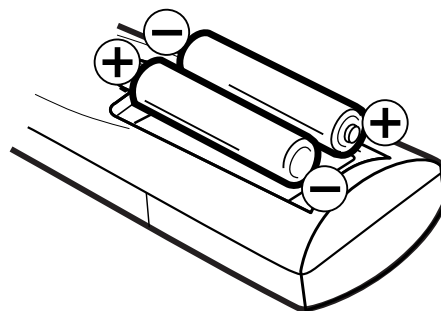

Use two "UM-4/AAA/IEC R03 1.5V" size batteries.

ONLY WHEN YOU TURN ON THIS SET FOR THE FIRST TIME, THE AUTOMATIC TUNING PROCESS WILL START AUTOMATICALLY.

1. Press **⏻** (main power) switch on the front panel, then press **⏻** (standby) on the remote control.
2. Press **OK** on your remote control.

Your TV will now automatically tune in all available channels. (See page 6 of Owner's Manual.)

3. AUTO TUNING

<p>1. Press MENU on your remote control. The on screen display will appear.</p> <p>Press P ▲ or P ▼ on your remote control to select SETUP menu.</p> <div data-bbox="560 376 770 548"> <p>PRESS : ▲/▼/OK/MENU/EXIT</p> </div>	<p>2. Press OK to confirm. The SETUP on screen display will appear.</p> <p>Press P ▲ or P ▼ to select AUTOMATIC TUNING.</p> <div data-bbox="1177 376 1388 548"> <p>PRESS : ▲/▼/OK/MENU/EXIT</p> </div>
<p>3. Press OK to confirm. This will start the automatic tuning process.</p> <ul style="list-style-type: none"> This process will take a few minutes to complete . . . please be patient. <div data-bbox="560 651 770 824"> </div>	<p>4. When the programme on the screen stops changing and the sound comes on, the tuning process is complete.</p> <p>Press EXIT to clear the CHANNEL MAPPING menu display.</p> <div data-bbox="1177 651 1388 824"> <p>PRESS : ▲/▼/RENAME/MOVEMENU/EXIT</p> </div>

4. MANUAL TUNING

<p>1. Select your TV channel to select your required channel number for tuning by pressing P ▲ or P ▼.</p> <p>Press MENU on your remote control.</p> <div data-bbox="560 1043 770 1216"> </div>	<p>2. Press P ▲ or P ▼ to select SETUP menu. Press OK to confirm.</p> <div data-bbox="1177 1043 1388 1216"> <p>PRESS : ▲/▼/OK/MENU/EXIT</p> </div>
<p>3. Press P ▲ or P ▼ to select MANUAL TUNING. Press OK to confirm.</p> <div data-bbox="560 1323 770 1496"> <p>PRESS : ▲/▼/OK/MENU/EXIT</p> </div>	<p>4. Press ▲ + to search up the waveband or ▼ - to search down the waveband. Each time a station is found the search will stop.</p> <ul style="list-style-type: none"> If you need to make the picture clearer, press P ▲ or P ▼ for Fine Tuning. Press ▲ + or ▼ - to continue searching until the station you want is found. <div data-bbox="1177 1373 1388 1545"> <p>PRESS : +/-/OK/MENU/EXIT</p> </div>
<p>5. Press OK to store the station you selected.</p> <p>Press P ▲ or P ▼ to select your required channel number (1-100). Press OK to store the channel number.</p> <div data-bbox="560 1637 770 1809"> <p>PRESS : +/-/▲/▼/OK/MENU/EXIT</p> </div>	<p>6. Repeat stages 4 - 5 for tuning other channels. Press EXIT to remove the tuning menu from the screen.</p> <div data-bbox="1177 1659 1388 1832"> </div>