



Owner's Manual
HANDS-FREE CAR
KIT

**For use with
Samsung phones
SPH-I300 & SCH-I300**

**Samsung Telecommunications America
1130 E. Arapaho Rd.
Richardson, TX 75081
Phone: 1-800-SAMSUNG
Customer Care: 1888-987-HELP
www.samsungtelecom.com**

**2001 Samsung Telecommunications America
All Rights Reserved. No Reproduction in Whole or
part allowed without prior written approval.
Printed in Korea**

Table of Contents

Unpacking	2
Installation	3
Installation notes	3
Hands-free Car Kit connection diagram	4
Installing the cradle	4
Installing the Hands-free box	5
Connecting the cradle to the Hands-free box	7
Installing the Hands-free microphone	8
Installing the external speaker	9
Connecting the power supply cable	9
Using the Hands-free Car Kit	11
Calibration	11
Precautions	12
Operating the Hands-free Car Kit	12
Attaching the phone to the cradle	12
Taking the phone when you leave the vehicle	13
Ignition sense	13
Battery charging	14
Using Voice Dial	15
Training the Hands-free Car Kit	16
Placing Voice Dial Calls with the Voice Dial Button	16
Setting up Voice Dial	17
Using your Voice Dial List	17
Managing your Voice Dial List	18
Voice Dial	18
To setup Voice Dial	18
Play or Erase Recorded Voice Names	19
Tips on Recording Names	19
Troubleshooting	20

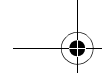

Please read this manual before operating your phone, and keep it for future reference.

Please read this guide before you use this equipment.

This owner's guide includes all the information necessary to make full use of your equipment's advanced features.

Professional Installation is strongly recommended for safety and performance of your hands-free car kit.

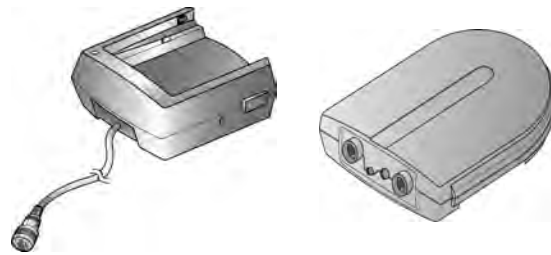

"Hands-free" means that you can have a conversation without holding the phone. It is recommended, however, that you not place a call while driving a vehicle.

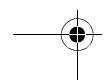
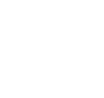
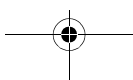
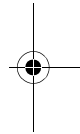
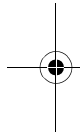

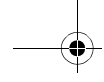

Unpacking

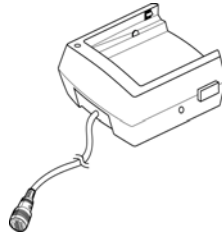

Cradle

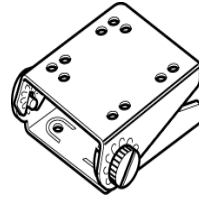

Mounting clamshell



Hands-free box

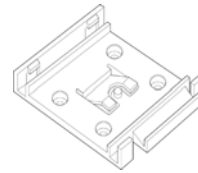

Mounting bracket

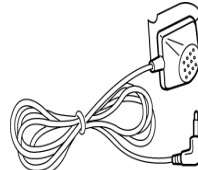

Hands-free microphone

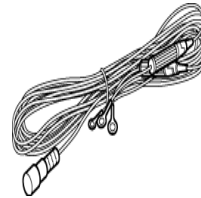

Power cable

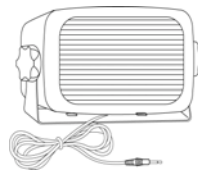

External speaker

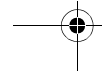
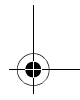
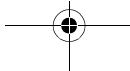
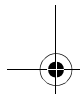
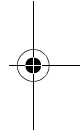
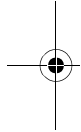

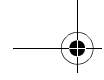

Installation

Installation notes

- The installing location should provide both clear visibility of the phone LCD display and keypad and unobstructed access for the Hands-free Car Kit.
- Care should be taken to position the microphone in a location which will be least susceptible to interference caused by external noise sources, for example, adjacent windows, radio speakers, etc.
- Please do not place the Hands-free Car Kit in an extreme environment where the temperature or humidity is high. Do not charge the phone battery when the temperature inside the vehicle is very high or very low.
- This Hands-free Car Kit is not used in common with any other Hands-free Car Kit.
- Use the Hands-free Car Kit with a 12V battery.

Note: If you want to use a battery voltage other than 12V, consult an authorized sales representative.

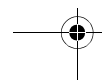
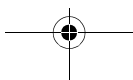
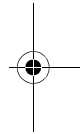
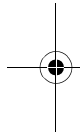

Hands-free Car Kit connection diagram

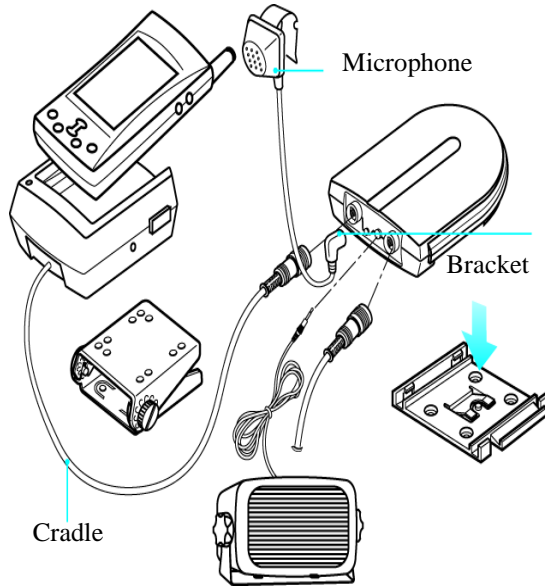

Installing the cradle

1. Choose a suitable mounting location.
 - The Hands-free Car Kit and connecting cables must not interfere with the driver's safe operation of the vehicle.
2. Mark the holes for the four mounting screws, and then drill the pilot holes. Mount the lower clamshell by using the four self tapping screws provided.
- Tighten the screws firmly to prevent them from working loose due to the vibration of a moving vehicle.
3. Attach the upper clamshell to the bottom of the cradle in the desired position using the four machine screws.

- Put the cradle on the lower clamshell. Adjust the mounting angle, and tighten the two large slotted screws.

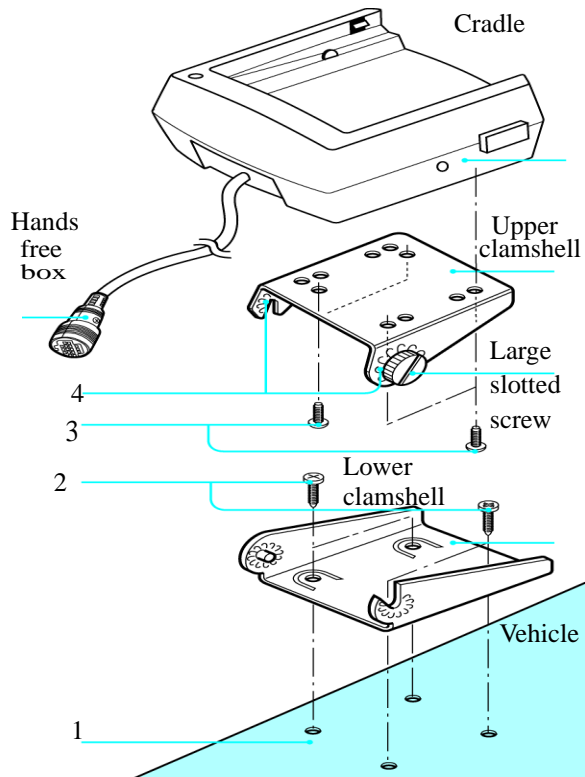

Installing the Hands-free box

- Choose a suitable mounting location for the Hands-free box.
 - The location must not interfere with the driver's safe operation of the vehicle.
- Drill the pilot holes using a drill bit, and install the mounting bracket by using the screws supplied.
 - Tighten the screws firmly to prevent them from working loose due to the vibration of a moving vehicle.

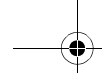

3. Attach the Hands-free box to the mounting bracket by snapping the box onto the bracket.

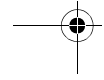
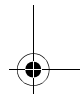
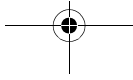
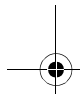
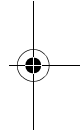
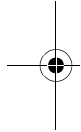
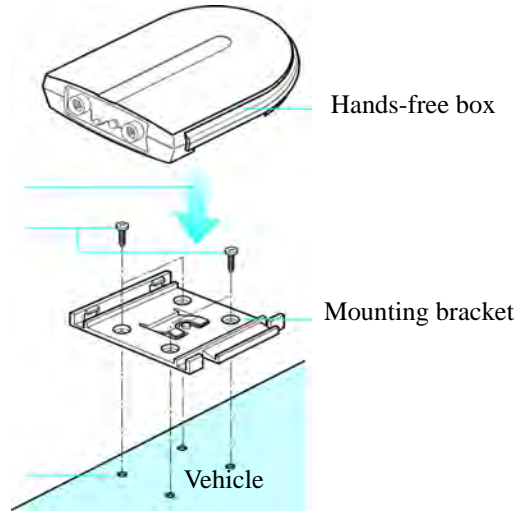

Connecting the cradle to the Hands-free box

1. Connect the data cable on the cradle to the 'DATA' terminal on the Hands-free box.

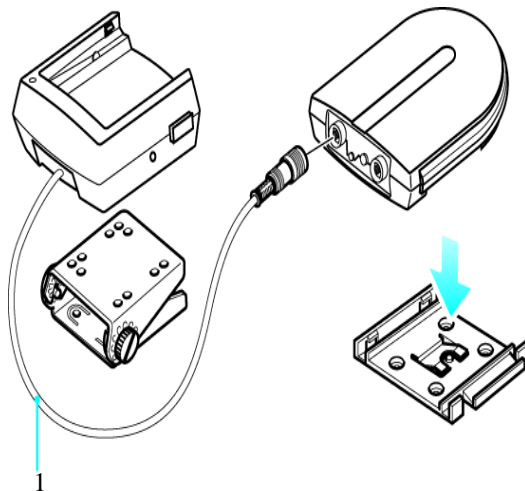

Installing the Hands-free microphone

1. Connect the microphone's connector jack to the 'MIC' terminal on the Hands-free box.
 2. Install the microphone at the proper location.
- The Hands-free microphone should be installed within 12-18 inches (30-45cm) proximity of the driver's normal speaking location. For optimum

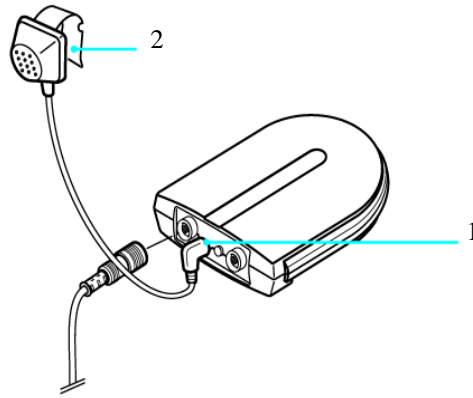

Installing the external speaker

The speaker is generally installed on the the passenger's seat side.

Note: Do not place the speaker near the microphone. Keeping the longest distance from the microphone will enhance voice quality.

1. Drill the pilot holes using a drill bit, and install the mounting bracket by using the screws supplied.
2. Connect the speaker's connector plug to the speaker terminal on the hands free box.

Note: Installation on the window or in front of cooling/heating vents will cause undesirable noises.

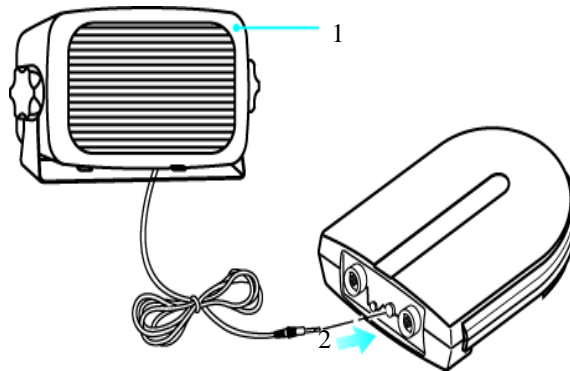

Connecting the power supply cable

There are four loose wires that connect the Hands-free Car Kit to the car's electrical system. Three of the wires must be connected. The fourth wire is an optional connection which allows you to mute the car stereo when you are on a phone call. When connecting the wires from the cable harness, be sure to avoid any sharp edges or moving parts.

- The red wire must be connected to the vehicle battery. Depending on how your vehicle is equipped, an auxiliary power connection may be found under the dash or near the fuse box. In newer vehicles

there may be a fuse box location for a cellular phone. Consult your vehicle owner's manual. The red wire has an in-line fuse holder. Be sure to use a 125V/3A fuse.

- The black wire must be connected to the vehicle ground (GND).
- The orange wire is the ignition sense. This wire must be connected to the switched side of the ignition switch. If an easy connection cannot be made, find a vehicle accessory on the fuse box that is turned on and off by the ignition switch, and connect the orange wire to this accessory. The orange wire has an in-line fuse holder. Be sure to use a 125V/3A fuse.
- The brown wire is the stereo mute. This wire does not have to be connected for the Hands-free Car Kit to work properly. Connect this wire to the stereo mute wire from your vehicle stereo (check your vehicle stereo owner's manual, or if the stereo is factory installed, check the vehicle owner's manual). The brown wire has an in-line fuse holder. Be sure to use a 125V/3A fuse.

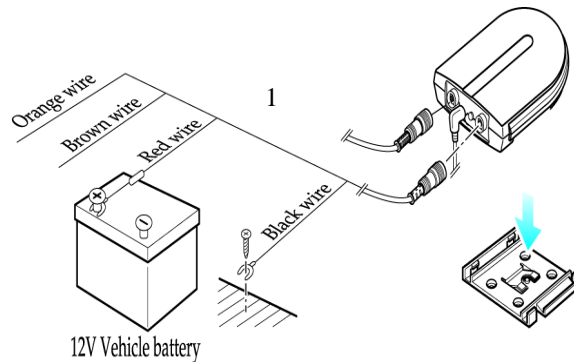

Using the Hands-free Car Kit

Calibration

The Hands-Free Car Kit needs to be set for the optimum calling condition.

1. Preparation for calibration
 - Connect the phone to the Hands-Free Car Kit as illustrated on page 13.
 - Turn off everything in your car that makes noise (radio, air conditioner, etc.). Shut all windows and doors, keep only the Hands-free Car Kit on.
2. Calibration Setting
 - The phone must be in the cradle.
 - Press and hold the calibration button (see Illustration below) for over 2 seconds while sitting in the driver's seat. Release the button.

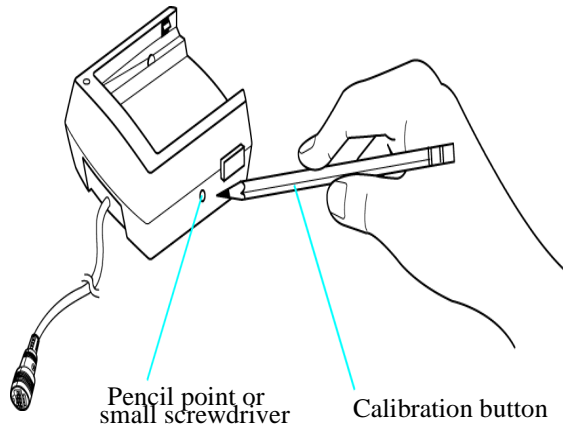

Note: If calibration is performed correctly, loud static and a single beep will be heard from the speaker. This indicates that the calibration was successful. If calibration is unsuccessful, the speaker beeps constantly. If this occurs, repeat steps.

Precautions

- Never move the speaker and the microphone after calibration. If you move them, and must be repeated. Repeat as necessary over time.

Operating the Hands-free Car Kit

The Hands-free Car Kit provides you with unlimited talk time while power is supplied from your vehicle, and allows you to have a conversation without holding the phone.

Attaching the phone to the cradle

To place the phone in the cradle:

1. Press and hold the side tabs on the side of your cradle.
 2. Insert the lower end of your phone.
 3. Push the upper part of your phone into the cradle until it snaps into place.
- “HFREE” appears momentarily on the display.
 - The phone will automatically power up if it was off.

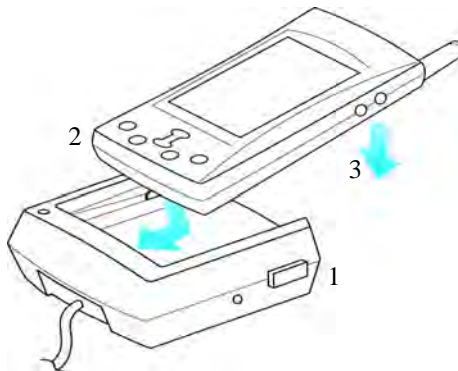

4. Enter the phone number. If the other party answers, begin the conversation.
- You can speak using the Hands-free microphone and hear your caller through the speaker.
 - To adjust the speaker volume, press the volum control button on the side of your phone.

Taking the phone when you leave the vehicle

When you leave the vehicle and want to take the phone with you:

1. Press and hold the release buttons on both sides of the cradle.
2. Lift the phone from the cradle.

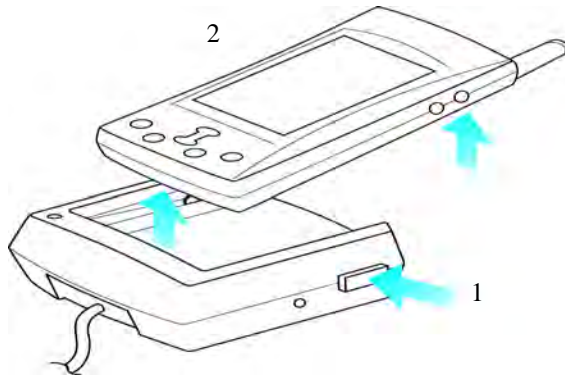

Ignition sense

When the ignition sense wire is properly installed, the following features will be provided:

The phone and Hands-free Car Kit will power off 20 seconds after the vehicle ignition switch is turned off. If the phone is removed before 20 seconds, the phone will stay on but the Hands-free Car Kit will turn off. When you are on a call, the Hands-free Car Kit will not turn off until you press the [END] or [PWR] key.

Battery charging

To charge the phone's battery you must do one of the following:

- Keep your car running (recommended)
- Make sure the ignition switch is on.

Note: If charging fails, the battery, the battery connectors or the phone may be bad. Check the connections and then try installing the battery again.

- When the inside temperature of your vehicle exceeds 118°F (50°C), leaving your battery pack in the vehicle may adversely effect the battery life.
- If you try to charge your battery when the temperature is outside the limits for charging (below 32°F [0°C] or above 104°F [40°C]), battery life will be reduced.
- When LED indicates orange, the battery is in standby mode until the battery temperature has changed to an appropriate charging temperature. The indicator light turns red when charging begins.

Table 1: status of charging
Lamp

Status	Lamp on cradle
Red	Charging
Green	Charging completed
Blinking orange	Charging fails

Table 2: Charging time

Time	Battery type
About 3 hours	Standard
About 4 hours	Extended

Using Voice Dial

To use Voice Dial, you need to “train” the phone to recognize your voice. You can put up to 20 names from your Address book into your Voice Dial list. Once you have recorded these names, you can make calls simply by speaking a name.

Note: This feature is only available in digital service areas.

Training the Hands-free Car Kit

To train the Hands-free Car Kit for Voice Dial:

1. Train the phone for Voice Dial in Hand-held mode, as specified in your phone Owner's Manual.
2. Place the phone in the cradle and wait for the voice and text prompts to guide you through the re-recording process. The Hands-free Car Kit will display "to retrain Hands-free Voice-Dial Press [OK]".
3. The Hands-free Car Kit will play the names as recorded in Hand-held mode. Respond to the prompt by repeating the name after the beep. The Hands-free Car Kit stores the name as a first sample, and then prompts for the name again.
4. Respond to the prompt by repeating the name after the beep. The Hands-free Car Kit stores the name as a second sample and automatically links it with the Voice Dial entry recorded in Hand-held mode.
5. If the Hands-free Car Kit cannot recognize the name because of noise, the Hands-free Car Kit will display "Cannot be recognized".

Placing Voice Dial Calls with the Voice Dial Button

Voice Dial is always active once you have trained the Hands-free Car Kit to accept Voice Dial entries.

Remember that Hands-free Voice Dial entries must be trained in Hand-held mode first, and then re-trained in the Hands-free environment. To place Voice Dial calls, press . Say the name into the microphone after you hear the voice prompt and the beep.

Note: The phone must be ON to make a Voice Dial call. If the phone is off when a Voice Dial call is attempted, a warning message is displayed that prompts you to turn the phone ON.

1. From the phone main menu, press  once on the left side of the phone.
 2. The Voice Dial screen is displayed.
 3. At the voice prompt, say the name into the phone.
- If the name is recognized, the phone number associated with the name is dialed.

- If the name is not recognized, the name is asked for again.
- If the name is not recognized after two attempts, a message is displayed that says “Could not recognize name”. Try the call again later, or record the entry name again.

Setting up Voice Dial

1. From the Phone Menu, tap the Menu Launcher icon. 
2. Select “Calls” and tap “Voice Dial List”.
3. Tap the “Add” button.
4. The list of available names is displayed from the address book. Tap the phone number next to the desired name.
5. The Set Voice Dial screen is displayed. Tap the down arrow next to Select.
6. Tap “Record”.
7. Record a name or number to identify the entry.
8. The entry is saved and ready for voice dial.

Using your Voice Dial List

1. From the Phone Menu, tap  and select Calls.
2. Tap “Voice Dial List”.
3. The list of available names is displayed from the address book. Scroll through the list of available names and tap the phone number of the desired name.
4. A Voice Dial popup menu is displayed with the following options:
 - **Call** - Calls the number.
 - **Modify** - Allows you to edit the entry.

Note: You can also access the Voice Dial screen from the Application main menu by tapping on the Voice Dial icon. 

Managing your Voice Dial List

You can play the recorded name, re-record the name, or erase the recording.

Play or Record:

1. From the Phone Menu, tap  and select Calls.
2. Tap “Voice Dial List”.
3. Select the name to edit and tap “Modify”.
4. The Set Voice Dial screen is displayed.
5. Tap the drop down arrow and select “Play”. Tap Re-Record to record the name again.

Erasing an entry:

1. From the Phone Menu, tap  and select Calls.
2. Tap “Voice Dial List”.
3. Select the name to edit and tap “Modify”.
4. The Set Voice Dial screen is displayed.
5. Tap the drop down arrow and select “Erase”.

Voice Dial

Voice dial allows you to speak a name or other identifier into the phone and have a number dialed from the Address Book. The recorded name is associated with the Address Book entry. You can use the Voice Dial feature with 20 different Address Book entries.

To setup Voice Dial

1. From the Applications main menu, tap the Address Book icon .
2. Tap the desired entry. The Address View screen is displayed.
3. Tap the “Edit” button. The Edit screen is displayed.
4. Tap the “Details” button.
5. Tap the “Set Voice Dial” button.
6. The Set Voice Dial screen is displayed. Tap the drop down menu and select “Record”.
7. Speak the name or identifier into the phone after the prompt. Follow the remaining instructions as they are given.

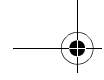

8. Tap “Done” to save. Notice that there is a Voice Dial icon next to the drop down arrow. This indicates that the entry has Voice Dial enabled.
9. Tap “Done” to exit.

Play or Erase Recorded Voice Names

1. From the Applications main menu, tap the Address Book icon.  Address
2. Tap the desired entry. The Address View screen is displayed.
3. Tap the “Edit” button. The Edit screen is displayed.
4. Tap the “Details” button.
5. Tap the “Set Voice Dial” button.
6. To play the recorded name, tap the drop down arrow and select “Play”.
7. To erase the entry, tap the drop down arrow and select “Erase”.
8. Tap “YES” to confirm the deletion.
9. Tap “Done” to exit.

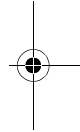
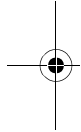

Tips on Recording Names

- Avoid recording similar names. If the names are too similar, the wrong name might be accessed.
- Avoid trying to record in a noisy area.
- Speak clearly.
- The person who uses the phone needs to record the name. The phone will only recognize the voice of the person who recorded the entry originally.
- Avoid very long or short names. Names with two to five syllables are recommended.
- If there are problems with the voice dial entry connecting, the name should be recorded again.

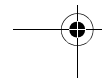
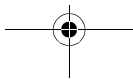

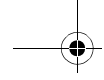

Troubleshooting

The phone does not turn on, even though the Hands-free Car Kit is connected to it.

- Check that the power cable of the Hands-free Car Kit is properly connected to the vehicle battery. You must turn on the vehicle ignition to supply power to the Hands-free Car Kit.
- If power is not supplied even though the vehicle ignition is turned on, unplug the power connector from the Hands-free box and then plug it again.
- Check the condition of the fuse connected to the power cable (red wire) of the Hands-free Car Kit.

