

THE NEW MAYTAG NEPTUNE® WASHER

USER

G U I D E

TABLE OF CONTENTS

Safety Instructions	1-2
Operating Instructions.....	3
Control Panel	4
Controls at a Glance.....	5-13
Features.....	14-15
Care & Cleaning	16
Storing the Clothes Washer.....	17
Before You Call.....	18-19
Operating Sounds	20
Questions and Answers	21
Warranty	23
Guide de l'Utilisateur	24
Guía del Usuario	48

IMPORTANT SAFETY INSTRUCTIONS

Welcome

Welcome and congratulations on your purchase of a Maytag Neptune® washer! Your complete satisfaction is very important to us. For best results, we suggest reading this material to help acquaint you with proper operating and maintenance procedures.

Should you need assistance in the future, it is helpful to:

- 1) Have complete model and serial number identification of your washer. This is located on a data plate on the back of the control panel.

Date of Purchase _____
Model Number _____
Serial Number _____

- 2) **IMPORTANT: Keep this guide and the sales receipt in a safe place for future reference. Proof of original purchase date is needed for warranty service.**

If you have questions, write us (include your model, serial number and phone number) or call:

Maytag Appliances Sales Company
Attn: CAIR® Center
P.O. Box 2370
Cleveland, TN 37320-2370
1-888-462-9824 USA and CANADA
1-800-688-2080 USA TTY
(for deaf, hearing impaired or speech impaired)
(Mon.–Fri., 8am–8pm Eastern Time)
<http://www.maytag.com>

For service and warranty information, see page 23.

NOTE: In our continuing effort to improve the quality of our appliances, it may be necessary to make changes to the appliance without revising this guide.

read before operating your washer

⚠ WARNING: To reduce the risk of fire, explosion, electric shock, property damage or injury to persons when using your appliance, follow basic precautions, including the following:

- 1 Read all instructions before using the appliance.
- 2 As with any equipment using electricity and having moving parts, there are potential hazards. To use this appliance safely, the operator should become familiar with the instructions for operation of the appliance and always exercise care when using it.
- 3 Do not install or store this appliance where it will be exposed to the weather.
- 4 Install and level the clothes washer on a floor that can support the weight.
- 5 This appliance must be properly grounded. Never plug the appliance cord into a receptacle which is not grounded adequately and in accordance with local and national codes. See installation instructions for grounding this appliance.
- 6 To avoid the possibility of fire or explosion:
 - a Do not wash items that have been previously cleaned in, washed in, soaked in, or spotted with gasoline, dry-cleaning solvents, other flammable or explosive substances as they give off vapors that could ignite or explode. Hand wash and line dry any items containing these substances.

Any material on which you have used a cleaning solvent, or which is saturated with flammable liquids or solids, should not be placed in the clothes washer until all traces of these liquids or solids and their fumes have been removed.

These items include acetone, denatured alcohol, gasoline, kerosene, some liquid household cleaners, some spot removers, turpentine, waxes and wax removers.
 - b Do not add gasoline, dry-cleaning solvents, or other flammable or explosive substances to the wash water. These substances give off vapors that could ignite or explode.
 - c Under certain conditions, hydrogen gas may be produced in a hot water system that has not been used for 2 weeks or more. **HYDROGEN GAS IS EXPLOSIVE.** If the hot water system has not been used for such a period, before using a washing machine or combination washer-dryer, turn on all hot water faucets and let the water flow from each for several minutes. This will release any accumulated hydrogen gas. As the gas is flammable, do not smoke or use an open flame during this time.

IMPORTANT SAFETY INSTRUCTIONS CONT.

- 7 Do not reach into the appliance if the tumbler is moving.
- 8 Do not allow children to play on or in the appliance. Close supervision of children is necessary when the appliance is used near children.
- 9 Do not tamper with controls.
- 10 Do not repair or replace any part of the appliance or attempt any servicing unless specifically recommended in published user-repair instructions that you understand and have the skills to carry out.
- 11 Unplug power supply cord before attempting to service your clothes washer.
- 12 Store laundry aids and other material in a cool, dry place where children cannot reach them.
- 13 Do not wash or dry items that are soiled with vegetable or cooking oil. These items may contain some oil after laundering. Due to the remaining oil, the fabric may smoke or catch fire by itself.
- 14 Do not use chlorine bleach and ammonia or acids (such as vinegar or rust remover) in the same wash. Hazardous fumes can form.
- 15 Do not machine wash fiberglass materials. Small particles can stick to fabrics washed in following loads and cause skin irritation.
- 16 Before the appliance is removed from service or discarded, remove the door to the washing compartment.
- 17 Do not sit on top of the clothes washer.
- 18 Inlet hoses are subject to damage and deterioration over time. Check the hoses periodically for bulges, kinks, cuts, wear or leaks and replace them every five years.

SAVE THESE INSTRUCTIONS

OPERATING INSTRUCTIONS

For detailed information on sorting, pretreating stains, etc., see the enclosed **Laundering Tips** booklet.

LOAD THE CLOTHES WASHER

- The tub can be loaded completely full with dry unfolded clothes. However, do not pack the tub tightly.
- Overloading may reduce washing efficiency and possibly cause creasing or wrinkling of the load.
- When washing big bulky items or a couple of small items that do not fill the tub completely, such as a rug or two sweaters, a few towels should be added for improved tumbling and spin performance.
- When washing heavily soiled loads, it is very important to avoid overloading the washer to assure good cleaning results.
- To load a forgotten item, press the **Start/Pause** touchpad, add the item, close the door and press the **Start/Pause** touchpad. After a 15 to 30 second pause, the cycle will resume.

NOTE: To assure that your additional items get clean, do not wait more than five minutes after the cycle has started to add the item.

Special Note: As you use the touchscreen, if you feel you are lost, press **Back** or **Home**.

STATUS DISPLAY

ESTIMATED TIME DISPLAY

After pressing start, this display will show the estimated time remaining in the cycle.

INDICATOR LIGHTS

Door Locked – Displays whenever the door of the clothes washer is locked. The door can be unlocked by pressing the **Start/Pause** touchpad to stop the washer.

WATER USE

The amount of water used will vary with each load. The Maytag Neptune® clothes washer uses an adaptive fill valve to provide the appropriate amount of water for efficient cleaning performance and conservation of water and energy.

estimated time: 40	main wash door locked
cotton/sturdy fabrics	options
hot wash cold rinse	end chime medium wrinkle free spin remind chime ON
normal soil 16 min. wash	

CONTROL PANEL

Touchscreen - An interactive display that responds with the touch of a finger.

Note: Exposure of the touchscreen to direct sunlight is not recommended.

Home - Takes you immediately to the first screen.

Off - Stops the washer and the turns off the display.

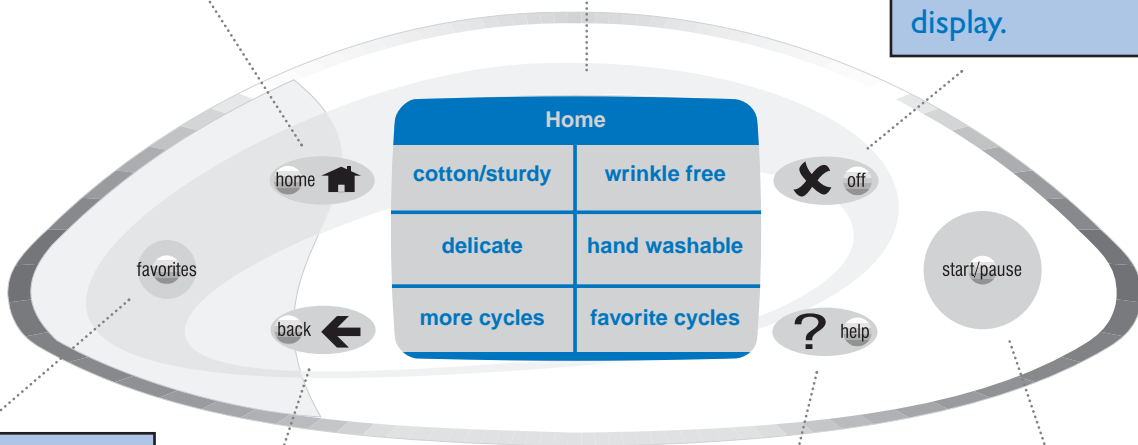

Favorites - Quick access to your named cycles.

Back - Takes you to the previous screen.

Help - Quick access to Stain Brain, Before You Call, Laundering Hints, Operating Tips, Lock Out and Select Preferences.

Start/Pause - Press this pad to start a cycle. Once started, pressing this pad will stop the washer at any point in the cycle.

Special Note: As you use the touchscreen, if you feel you are lost, press **Back** or **Home**.

CONTROLS AT A GLANCE

SETTING A WASH CYCLE

If there are no words on the touchscreen, open the door, touch any pad (except off), or touch the screen to “wake” the controls.

Home	
cotton/sturdy	wrinkle free
delicate	hand washable
more cycles	favorites

Step 1

Home Screen – Select the appropriate fabric setting.

Wash/Rinse Temperature	
hot wash cold rinse	warm wash warm rinse
warm wash cold rinse	cold wash cold rinse

Step 2

Wash/Rinse Temps – Select the appropriate wash/rinse temperature.

Soil Level/Wash Time	
extra heavy soil 34 min. wash	
heavy soil 24 min. wash	normal soil 16 min. wash
light soil 10 min. wash	quick 5 min. wash

Step 3

Soil Level/Wash Time – Select the appropriate soil level/wash time.

Press "Start/Pause" or change your selections below.

cotton/sturdy fabrics	options
hot wash cold rinse	end chime medium extra rinse ON remind chime ON
normal soil 16 min. wash	

Step 4

Review Screen – This screen reviews your selections before starting the washer. You may press **Start/Pause** to begin washing or press a displayed choice to change previous selections.

Options	
extra rinse on off	medium end of cycle chime
pre-soak on off	wrinkle free spin
stain cycle on off	delay wash on off
remind chime on off	continue

Step 5

Options Screen – The option choices on the left turn the options on or off. Some option choices on the right show an additional screen with multiple choices. When the desired selections are made, touch **Continue** to see the review screen once again.



Step 6

If you are satisfied with the selections, press the **Start/Pause** pad to begin the cycle.

Special Note: As you use the touchscreen, if you feel you are lost, press **Back** or **Home**.

FAVORITES AT A GLANCE

Favorites allows you to create, name and save up to 24 commonly used wash cycles.

“Blue jeans” and “towels” favorite cycles have been programmed for you. To change these cycles for your preferences, see Edit a Favorite on page 7.

CREATE A FAVORITE

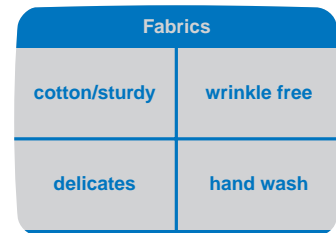
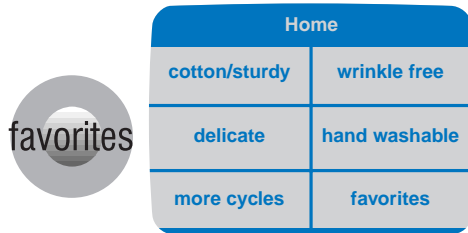

Step 1

Touch “Favorites” on the home screen or the Favorites pad.

Step 2

Touch “Create a Favorite”.

Step 3

Fabrics – Select the appropriate fabric setting.

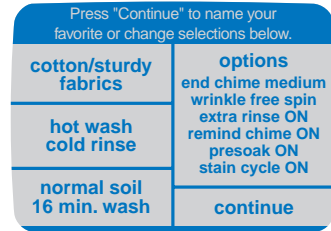
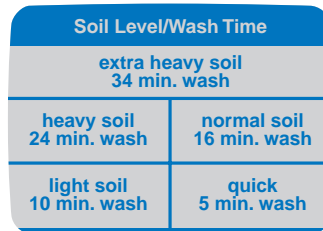
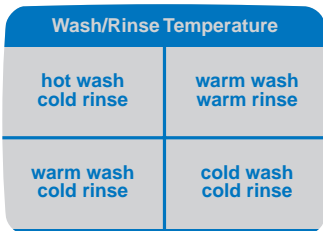

Step 4

Wash/Rinse Temps – Select the appropriate wash/rinse temperature.

Step 5

Soil Level/Wash Time – Select the appropriate soil level/wash time.

Step 6

Review Screen – This screen reviews your cycle choices, and allows you to choose Options to further customize your wash cycle. Press “Options” if desired, or press “Continue”.

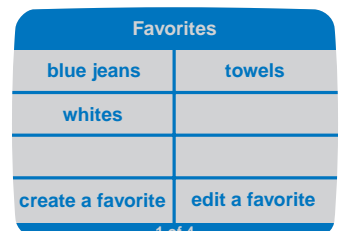
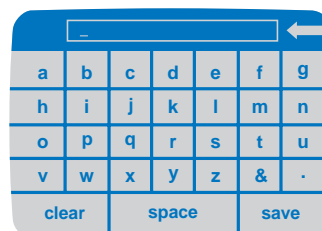

Step 7

Options Screen – The option choices on the left turn the options on or off. Some option choices on the right show an additional screen with multiple choices. When the desired selections are made, touch “Continue” to see the review screen once again.

Step 8

If satisfied with your selections, press “Continue” to name your favorite cycle.

Step 9

Name A Favorite Cycle – Touch the corresponding letter and space combination to spell out your favorite cycle name, up to 12 characters. Press “Save”. Your new Favorite Cycle will be displayed on the Favorites page.

CONTROLS AT A GLANCE CONT.

EDIT A FAVORITE

This allows you to change the settings of any favorite cycle.

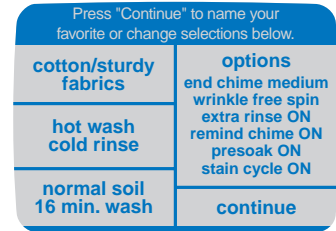

Step 1

Touch **"Favorites"** on the home screen or the **Favorites** pad.

Step 2

Touch **"Edit A Favorite"** Touch the favorite cycle you want to edit.

Step 3

The review screen for that specific cycle will be displayed. Make the appropriate changes by touching the area. Press **"Continue"**.

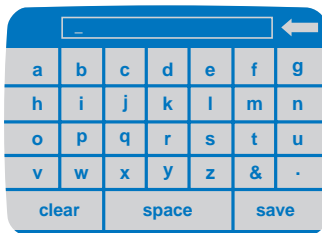

Step 4

If the current favorite cycle name still applies, touch **"Save"**. If you prefer a new name, type in the new name and touch **"Save"**.

Special Note: As you use the touchscreen, if you feel you are lost, press **Back** or **Home**.

MOVE A FAVORITE

Home	
cotton/sturdy	wrinkle free
delicate	hand washable
more cycles	favorites



Favorites	
blue jeans	towels
dress shirts	whites
blankets	sweaters
create a favorite	edit a favorite

1 of 4

Step 1

Touch **“Favorites”** on the Home screen or the **Favorites** pad.

Step 2

Touch **“Edit a Favorite”**.

Select Favorite To Edit	
blue jeans	towels
dress shirts	whites
blankets	sweaters
move favorite to first page	return without making changes

1 of 4

Select Favorite To Edit	
khakis	
move favorite to first page	return without making changes

2 of 4

Favorites	
khakis	blue jeans
towels	dress shirts
whites	blankets
move favorites to first page	return without making changes

1 of 4

Favorites	
sweaters	
move favorite to first page	return without making changes

2 of 4

Step 3

Touch the area entitled **“Move Favorite to First Page”**. Using the arrow at the top, scroll through the pages until you get to the favorite you would like to move to the first page. Touch that favorite cycle.

Step 4

Now the favorite cycle should appear in the upper left position of the touchscreen. The other favorites cycles move back one position with the sixth favorite cycle moving to the next page.

Special Note: As you use the touchscreen, if you feel you are lost, press **Back** or **Home**.

CONTROLS AT A GLANCE CONT.

USING HELP

The Help feature offers a variety of detailed information including the stain brain, before you call, laundry hints, operating tips, lock out feature and select preferences.

This section of the user guide will demonstrate how to easily navigate to the main areas of the topics. From there, you will easily be able to narrow your search for finding laundry information.

STAIN BRAIN

The Stain Brain provides detailed steps to treat over 50 of the most common stains. The Stain Brain also offers the user the option of all automatically setting the washer cycle for the particular stain.



Help Screen	
stain brain	before you call
laundry hints	operating tips
lock out feature	select preferences

Touch first letter of stain						
a	b	c	d	e	f	g
h	i	j	k	l	m	n
o	p	q	r	s	t	u
v	w	x	y	z	unknown	

Step 1

Touch the **Help** touchpad.

Step 2

Select **“Stain Brain”**.

Step 3

Select the letter of the stain you want to remove.

"B" Stains	
baby formula	beverages
blood	butter

Baby Formula
1. Use the Pre-Soak option with warm water or soak in warm water for 1/2 hour.
2. Launder with appropriate bleach and hottest water safe for the fabric and color.
3. Select the Stain Cycle option and Extra Heavy wash time.
4. If a greasy-looking stain remains, re-laundry.
set washer for this stain

Press "Continue" to name your favorite or change selections below.	
cotton/sturdy fabrics	options end chime medium wrinkle free spin extra rinse ON remind chime ON presoak ON stain cycle ON
hot wash cold rinse	
normal soil 16 min. wash	continue

Step 4

Select the appropriate stain listing.

Step 5

To automatically set the washer to run the appropriate cycle for the selected stain, touch **“Set Washer For This Stain”**.

Step 6

Review Screen - This screen reviews the selections made by the Stain Brain before starting the washer. Press **Start/Pause** to begin washing, or press a displayed choice to change selections.

Note: Use the arrows at the top of the letter screen to scroll from letter to letter.

BEFORE YOU CALL



Help Screen	
stain brain	before you call
laundry hints	operating tips
lock out feature	select preferences

Before You Call →	
won't fill	won't tumble
won't spin or drain	is noisy
washer stops	leaks water
To answer questions or request service, call PriorityOne at 1-888-462-9824	
1 of 2	

Is Noisy
<ul style="list-style-type: none">Your Maytag Neptune washer should be properly leveled.Weak floors can cause vibration and walking.Be sure the rubber feet are installed on the legs.Check that the leveling leg lock nuts are tight.

Step 1

Touch the **Help** touchpad.

Step 2

Select "**Before You Call**".

Step 3

Here you will see headings for common trouble-shooting topics. Touch one of the displayed areas to see specific information. Touch the arrows at the top of the screen to move forward or back through the topics. For more detailed information see "Before You Call" section pg. 18-19, or call 1-888-462-9824 for further assistance.



Step 4

If you would like to see the other topics, press the **Back** touchpad to get back to the main topics.

Special Note: As you use the touchscreen, if you feel you are lost, press **Back** or **Home**.

CONTROLS AT A GLANCE CONT.

LAUNDERING HINTS



Step 1

Touch the **Help** touchpad.

Help Screen	
stain brain	before you call
laundry hints	operating tips
lock out feature	select preferences

Step 2

Select “**Laundry Hints**” from the Help screen.

Laundry Hints	
washer additives	washer sorting
detergents	pre-treating
water temperature	cycles
dryer hints	

Step 3

Here you will see the available topics. Touch the topics to see specific information.

Washer Additives	
color-safe bleach	
chlorine bleach	fabric softener
starch	bluing

Color-Safe Bleach
<ul style="list-style-type: none">Color-safe bleach should be added in with detergent at the beginning of the cycle for most benefit.Color-safe bleach can be used on most items. It is most effective when used with a warm or hot water wash.



Step 4

Touch the sub-topic to see specific information.

Step 5

If you would like to see the other topics, press the **Back** touchpad to get back to the main topics.

Special Note: As you use the touchscreen, if you feel you are lost, press **Back** or **Home**.

OPERATING TIPS



Step 1

Touch the **Help** touchpad.

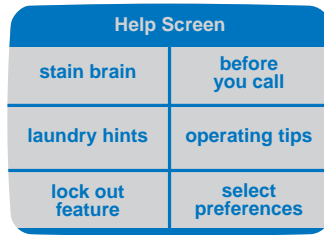

Step 2

Select “**Operating Tips**” from the Help Screen.

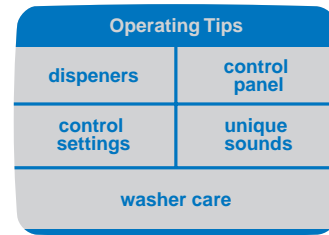

Step 3

“**Operating Tips**” provides information on maximizing the touchscreen controls and use of your washer.



Step 4

If you would like to see the other topics, press the **Back** touchpad to get back to the main topics.

LOCK OUT FEATURE



Step 1

Touch the **Help** touchpad.

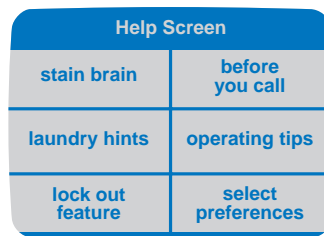

Step 2

Select “**Lock Out Feature**” from the Help Screen.

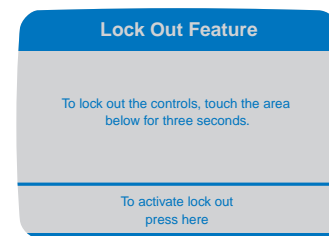

Step 3

The “**Lock Out Feature**” deactivates the touchscreen and touchpads. Use this feature for cleaning the control panel or to prevent unwanted use of the washer.



Step 4

If you would like to see the other topics, press the **Back** touchpad to get back to the main topics.

CONTROLS AT A GLANCE CONT.

SELECT PREFERENCES



Help Screen	
stain brain	before you call
laundry hints	operating tips
lock out feature	select preferences

Select Preferences	
medium touch screen volume	change language to English
auto start on off	changer pour le Français
change monitor contrast	cambiar al Español
energy saver on off	

Step 1

Touch the **Help** touchpad.

Step 2

Select **“Select Preferences”**. **“Select Preferences”** allows you to select the volume of the touchscreen beeps, set the intensity of the screen display, activate the Auto Start and Energy Saver functions, and change the display language from English to French or Spanish.

TOUCHSCREEN VOLUME

Touch Screen Volume	
This provides audible feedback upon making selections on the touch screen.	
loud	medium
soft	off
continue	

Touch **“Loud”**, **“Medium”**, **“Soft”** or **“Off”** to set the volume level of the touchscreen beeps. Touch **“Continue”** to accept the selected volume setting.

CHANGE MONITOR CONTRAST

Use the arrow key to adjust the contrast of the viewing screen.	
←	→
default	continue

Depending on the lighting in your home and other factors, you may want to adjust the intensity of your touchscreen. Touch the arrows to lighten or darken the display. Touch **“Continue”** when finished.

CHANGE LANGUAGE

English to French De l'anglais au français	
Are you sure you would like to change the language to French?	
Souhaitez-vous vraiment sélectionner le français?	
Yes/Oui	No/Non

You have the ability to change the language between English, French and Spanish. You will always see the next screen in the selected language to make sure you want to change the language.

AUTO START

Auto Start	
If "Auto Start On" is chosen, the washer will automatically start when the cycle is selected. Once selected, it remains on until "Auto Start Off" is selected.	
Auto Start On	Auto Start Off

When **“Auto Start on”** is chosen, the washer will automatically start when the cycle is selected.

ENERGY SAVER

Energy Saver	
This washer is equipped with a heater to improve cleaning performance. If "Energy Saver On" is selected, the heater is off.	
Energy Saver On	Energy Saver Off

Selecting **“Energy Saver on”** deactivates the internal water heater. **“Energy Saver off”** activates internal water heating for improved cleaning performance.

Special Note: As you use the touchscreen, if you feel you are lost, press **Back** or **Home**.

FEATURES

DETERGENT

Your Maytag Neptune® washer is designed to use either high efficiency (HE) detergents or regular detergents normally used with top-loading washers.



- For best cleaning results, use a high efficiency detergent such as Tide HE or Wisk HE*. High efficiency detergents contain suds suppressors which reduce or eliminate suds. When less suds are produced, the load tumbles more efficiently and cleaning results are maximized.
- When using regular detergent formulated for top-loading washers, it is important to pay close attention to the soil level of the load, load size, and water hardness**. To avoid over-sudsing, reduce the amount of detergent used with soft water or with small or lightly soiled loads.

If using the “PRESOAK” setting, measure 1-1/2 times the amount of detergent.

* Brand names are trademarks of the respective manufacturers.

** To determine water hardness in your area, contact your local water utility or State University Extension office in your area.

AUTOMATIC DISPENSER

The automatic dispenser consists of three compartments which hold 1) liquid or granular detergent and color safe bleach, 2) liquid chlorine bleach and 3) liquid fabric softener. All laundry products can be added at once in their respective dispenser compartments. They will be dispensed at the appropriate time for most effective cleaning.

After loading the laundry additives into the dispenser, close the dispenser lid.

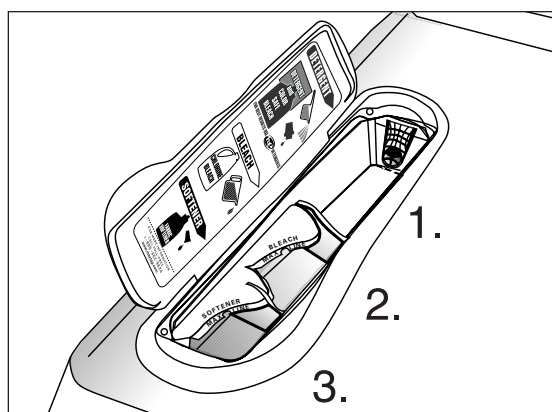

DETERGENT COMPARTMENT

1. Pour laundry detergent directly into the detergent compartment before starting the clothes washer or as the washer is filling.
2. If color-safe bleach is to be used, it should be added with detergent to the detergent compartment for best results.
- When adding color-safe bleach with detergent, it is best if both laundry products are in the same form; granular or liquid.

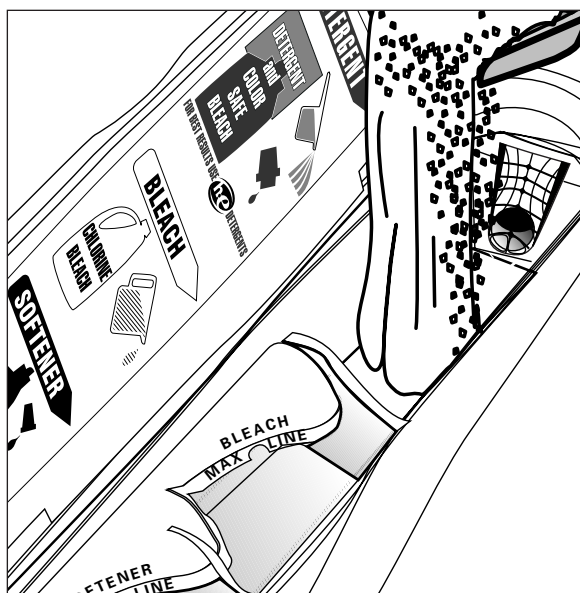

BLEACH COMPARTMENT

(Chlorine Bleach Only)

1. Add chlorine bleach to the bleach compartment DO NOT exceed the MAX FILL line. The chlorine bleach compartment will hold 3/4 of a cup.
2. Avoid splashing or over-filling the compartment. **Over-filling the compartment will release the chlorine bleach into the clothes washer too early.**
3. The washer automatically dispenses bleach into the tub when there are approximately two minutes left in the wash portion of the cycle. This maximizes the effectiveness of the bleach.
4. The dispenser automatically dilutes liquid chlorine bleach before it reaches the wash load.

NOTE:

- Never pour undiluted liquid chlorine bleach directly onto the load or into the tub. It is a powerful chemical and can cause fabric damage, such as weakening of the fibers or color loss, if not used properly.
- If you prefer to use color-safe, non-chlorine bleach, add it to the detergent compartment. **Do not pour color-safe bleach into the bleach compartment.**



SOFTENER COMPARTMENT

1. Pour the recommended amount of liquid fabric softener into the softener compartment. For smaller loads use less than one cap full.
2. Fabric softener may be diluted with warm water until it reaches the MAX FILL line on the compartment. **Do not dilute the liquid fabric softener compartment above the MAX FILL line. If the compartment is filled above the MAX FILL line, fabric softener will enter the clothes washer too early.**
3. This compartment automatically dilutes and releases liquid fabric softener at the proper time during the rinse cycle.

NOTE:

- Use the softener compartment only for liquid fabric softeners.
- Using the Downy Ball* is not recommended with this washer. It will not add fabric softener at the appropriate time. Use the dispenser on top of the washer.

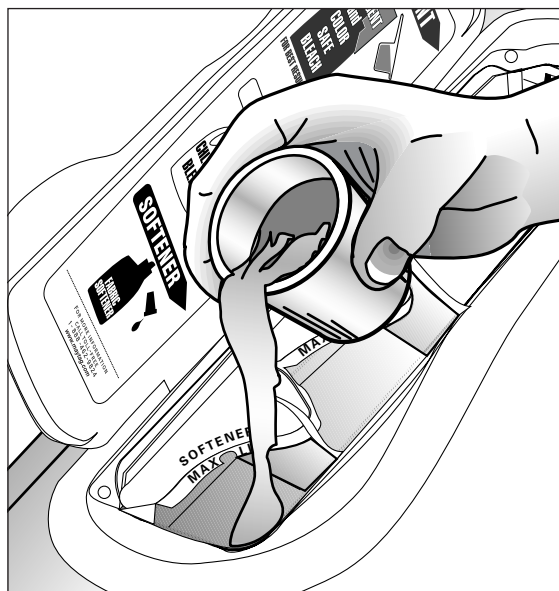

* Brand names are trademarks of the respective manufacturers.

CARE AND CLEANING

Turn off the water faucets after finishing the day's washing. This will shut off the water supply to the clothes washer and prevent the unlikely possibility of damage from escaping water.

Use a soft cloth to wipe up all detergent, bleach or other spills as they occur.

CLEANING THE DISPENSER

The dispenser may need to be cleaned periodically due to laundry additive build-up. For easy clean-up of the dispenser, grasp the removable two-compartment container (for bleach and softener) as shown in illustration #1. As you begin to lift the two-compartment container, tilt slightly inward, according to illustration #2 and remove from the main dispenser.

Once the two-compartment container is removed from the main dispenser, take it to a sink. Follow illustration #3 to

Clean the following as recommended:

Control Panel – clean with a soft, damp cloth. Do not use abrasive powders or cleaning pads. Do not spray cleaners directly on the panel.

Cabinet – clean with soap and water.

Interior – hard water deposits may be removed, if needed, using a recommended cleaner labeled clothes washer safe.

remove the cap covering the siphon tube for the bleach and softener. Run warm water and a soft brush or cloth over the two parts to remove any excess laundry additives.

Clean the main dispenser area using water and a soft cloth. Once the main dispenser is clean, follow the illustrations in reverse order to replace the two compartment container to its original location.

NOTE: Do not use any cleaning substance but water in the main dispenser. It is possible for cleaning substances to drain into the tub. If this should happen, set the washer for a rinse and spin cycle to remove any cleaning substance from the washer before doing a load of laundry.

Step 1

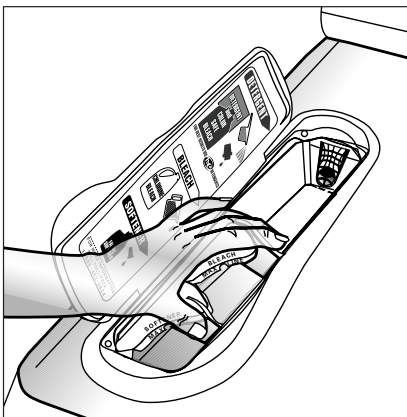

Step 2

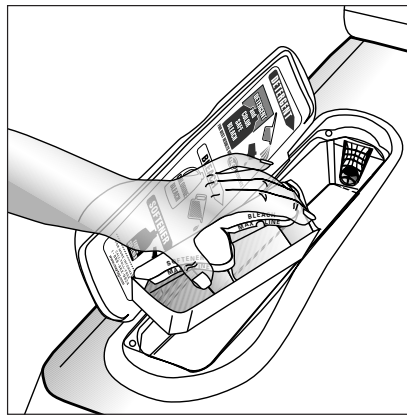

Step 3

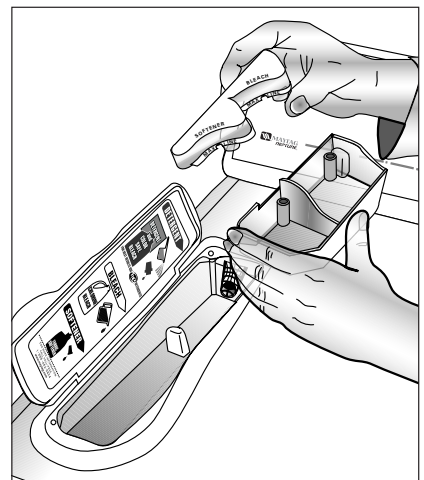

STORING THE CLOTHES WASHER

Washers can be damaged if water is not removed from hoses and internal components before storage. Prepare the washer for storage as follows:

- Select the “COTTON/STURDY” and “QUICK” setting and add one cup of bleach to the detergent dispenser without clothes in the tumbler. Run the clothes washer through a complete cycle.
- Turn the water faucets off and disconnect the inlet hoses.
- Disconnect the clothes washer from the electrical supply and leave the washer door open to let air circulate inside the tumbler.
- If the washer has been stored in below-freezing temperatures, allow time for the washer to thaw out prior to use.

For information on long-term storage or storage of your washer during extreme cold temperatures, call Maytag Customer Service toll-free at 1-888-462-9824. U.S. customers using TTY for deaf, hearing impaired or speech impaired, call 1-800-688-2080.

REPLACING INTERIOR LIGHT

Instructions for replacing the bulb:

- 1) **Unplug or disconnect the clothes washer from the electrical power supply.**
- 2) Open the door.
- 3) Unscrew the light bulb counter clockwise from the socket.
- 4) Replace the bulb with a **10 watt** candelabra base light bulb and rotate clockwise.
- 5) Plug in or reconnect clothes washer to the power supply.

REVERSING THE CLOTHES WASHER DOOR

Clothes washer door swing direction can be changed using the following procedure:

- 1) Swing door fully open and support it while removing four hinge screws (which hold hinges to door assembly).
- 2) Move door to a work surface and transfer four color matched door screws to the opposite side of the door assembly.
- 3) Remove one screw holding top hinge to cabinet and one screw holding top hinge cover to cabinet (opposite side).
- 4) Remove hinge and bracket from cabinet by moving them up and down to a position where they are released.
- 5) Install hinge and bracket in swapped locations and drive screws to attach them securely to the cabinet.
- 6) Compare top hinge and top bracket to bottom hinge and bottom bracket for correct hinge assembly position.
- 7) Repeat procedures 4 through 6 for bottom hinge to cabinet and bottom bracket to cabinet.
- 8) Support door in fully open position on hinge side and drive four screws to securely attach hinges to door assembly.
- 9) Close door and check to see that clothes washer operates properly.

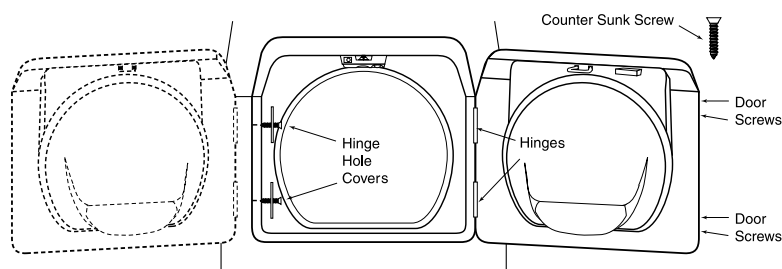

For problem laundry solutions (i.e. fabric damage, residue, tangling) and special laundry care procedures, see the enclosed Laundering Tips booklet.

CHECK THESE POINTS IF YOUR MAYTAG NEPTUNE® WASHER...

Load is Too Wet at End of Cycle

- Use Max Extract Spin Speed option.
- Try using a high efficiency detergent to reduce sudsing.
- Load is too small. Very small loads (one or two items) may not spin out completely.

Leaks Water

- Make sure door is firmly closed.
- Make sure hose connections are tight.
- Make sure end of drain hose is correctly inserted and secured to drain facility.
- Avoid overloading.
- Use high efficiency detergent to prevent over-sudsing.

Won't Spin or Drain

- Check fuse or reset circuit breaker.
- Straighten drain hoses. Eliminate kinked hoses. If there is a drain restriction, call for service.
- Close the door and push the START/PAUSE touchpad. For your safety, washer will not tumble or spin unless the door is closed.
- After pressing the START/PAUSE touchpad, it will take a few moments before the clothes washer begins to spin. The door must lock before spin can be achieved.
- See "Tub is Completely Full of Suds" below.

Stops

- Plug cord into live electrical outlet.
- Check fuse or reset circuit breaker.
- Close door and push the START/PAUSE touchpad to start the clothes washer. For your safety, washer will not tumble or spin unless door is closed.
- This may be a pause or soak period in the cycle. Wait briefly and it may start.
- Check screens on inlet hoses at the faucets for obstructions. Clean screens periodically.

Tub is Completely Full of Suds

- Run the clothes washer through another complete cycle using cold water.
- Reduce detergent amount for that specific load size, soil level and water hardness.
- Use high efficiency or low sudsing detergent specially formulated for front load washers.

Fills with the Wrong Temperature Water

- Turn both faucets on fully.
- Make sure temperature selection is correct.
- Make sure hoses are connected to correct faucets and inlet connections. Flush water line before filling washer.
- Check the water heater. It should be set to deliver a minimum 120°F (49°C) hot water at the tap. Also check water heater capacity and recovery rate.
- Disconnect hoses and clean screens. Hose filter screens may be plugged.
- When warm rinse is selected, only the final rinse will be warm. The first two rinses will be cold.
- While the washer is filling for cold or warm wash temperatures, both hot and cold water will go through the dispenser as the automatic temperature control feature checks incoming water temperatures. This is normal and will only happen the first time the washer is used.

CONTINUED

CHECK THESE POINTS IF YOUR MAYTAG NEPTUNE® WASHER...

Won't Fill

- Be sure the door is tightly closed.
- Plug cord into a live electrical outlet (tub light should illuminate).
- Check fuse or reset circuit breaker.
- Open and close the door, then push the START/PAUSE touchpad.
- Turn both faucets on fully.
- Straighten inlet hoses.
- Disconnect hoses and clean screens. Hose filter screens may be plugged.
- Open and close the door, then push the START/PAUSE touchpad.

Won't Tumble

- Check fuse or reset circuit breaker.
- Open and close the door and press the START/PAUSE touchpad. For your safety, the clothes washer will not tumble or spin unless the door is closed.

**Door Locked Shut;
Will Not Open**

- Press the START/PAUSE touchpad to stop the washer.
- It may take a few moments for the door lock mechanism to disengage.

**Freshening
Your Washer**

- Open the door and wash the lower portion of the gray door seal with a solution of 1 cup chlorine bleach to 2 cups water.
- Select the following control panel setting: Cotton Sturdy, Hot/Cold, Heavy soil setting.
- Fill the bleach dispenser cup with liquid chlorine bleach and start the washer.
- Pour an additional 1/2 cup bleach into the detergent dispenser as the washer is filling.
- Allow the washer to complete the cycle.
- At the end of the cycle, open the door and dry the gray door seal.

Is Noisy

- Clothes washer should be leveled properly as outlined in installation instructions.
- Check the leveling leg lock nuts are tightened.
- Be sure rubber feet are installed on leveling legs.
- Weak floors can cause vibration and walking.
- For information on normal operating sounds, see page 20.

For further assistance, call Maytag Customer Service toll-free at 1-888-4-MAYTAG (1-888-462-9824).

U.S. customers using TTY for deaf, hearing impaired or speech impaired, call 1-800-688-2080.

NORMAL OPERATING SOUNDS OF YOUR MAYTAG NEPTUNE® CLOTHES WASHER

High pitched sound during a spin cycle.

The motor increases speed to spin the tub to remove moisture from the load.

Flushing water sound coming from the dispenser area.

Detergent is dispensed at the start of the cycle. Bleach is dispensed during final minutes of wash. Fabric softener is dispensed during the third rinse while the washer is filling.

Sloshing or gurgling water sound when washer is off and the tub is rotated.

The sealed balance ring around the tub contains a liquid and is designed to make the washer spin smoothly.

“Whirring” or “Sloshing” sound followed by a pause, repeated throughout the wash cycle.

The tub rotates one direction followed by a pause. The tub reverses direction and pauses. This action continues throughout the cycle.

Clothes washer maintains a **slightly reduced spin speed** after achieving a higher spin speed.

After reaching the maximum spin speed, the machine may reduce spin speed slightly to create less noise and vibration.

The spin speed **slows down dramatically** when it sounds like an out-of-balance load.

The tumbler will begin to accelerate to speed, then slows back down to redistribute the load more evenly when an unbalanced load occurs.

Water is added after the washer has been tumbling for a while.

The Maytag Neptune® clothes washer uses a true adaptive fill and adds more water during the wash cycle as it is needed.

OR

Water flows through the dispenser to dilute and add bleach or fabric softener at the appropriate time. This will occur even if bleach and fabric softener are not used.

Clicking/draining sounds when washer is started.

Before the washer starts to fill, it will make a series of clicking noises to check the door lock and do a quick drain.

2 QUESTIONS & ANSWERS

Q. What's the best cycle to use if I have stains on my laundry?

A. Select Cotton/Sturdy fabrics and the Heavy soil wash time. Pretreat the stains with a laundry pre-treat product. Refer to the “**Stain Brain**” under **Help** for more information on treating specific stains.

Q. How large of a load can I wash in my Maytag Neptune® washer?

A. The tub can be loaded completely full with dry, unfolded clothes. However, do not pack the tub tightly. If the load is heavily soiled it is very important not to overload the washer.

Q. At the end of the cycle my load comes out wetter than normal. What causes this?

A. During tumble and spin the washer may have had difficulty getting to a full spin speed because the load was not evenly distributed. This can occur with small loads, heavy items or a load in which too much detergent was used, causing over-sudsing. Redistribute the load in the washer, close the door and follow these steps. Touch “**More Cycles**”, “**Spin**”, and **Start Pause**.

Q. My laundry items seem to be very wrinkled at the end of the cycle. What can I do to correct the problem?

A. Wrinkling is caused by the combination of heat and pressure. Be sure wrinkle free or permanent press fabrics are washed on the Wrinkle Free cycle, and a cold rinse is used. (See pg. 5 for WASH/RINSE Temperature). DO NOT USE MAX-EXTRACT.

Q. My whites are not as white as I'd like. What can I do?

A. Wash white loads using the Cotton Sturdy fabric selection. Select the hot wash/cold rinse temperature setting and put 3/4 cup of chlorine bleach in the bleach dispenser. The bleach will be dispensed in the final minutes of the wash providing for optimal whitening. Maytag recommends a hot water wash temperature of 120-140° F (49° - 60° C).

C LOTHES WASHER WARRANTY

Full One Year Warranty

For **one (1) year** from the date of original retail purchase, any part which fails in normal home use will be repaired or replaced free of charge.

Limited Warranty

After the first year from date of original retail purchase, through the time periods listed below, the parts designated below which fail in normal home use will be repaired or replaced free of charge for the part itself, with the owner paying all other costs, including labor, mileage and transportation.

Second Year – All parts.

Third through Fifth – Electronic control.

Third through Tenth – Drive motor.

Third through Lifetime – Stainless steel inner wash basket.

Additional Limited Warranty Against Rust-Through

Should an exterior cabinet, including the top and baseframe, rust through during the one year period starting from the date of retail purchase, repair or replacement will be made free of charge. After the first, and through the tenth year, repair or replacement will be made free of charge for the part itself, with the owner paying all other costs, including labor, mileage and transportation.

Please Note: This full warranty and the limited warranty apply when the washer is located in the United States or Canada. Washers located elsewhere are covered by the limited warranty only, including parts which fail during the first two years.

The specific warranties expressed above are the **ONLY** warranties provided by the manufacturer. This warranty gives you specific legal rights, and you may also have other rights that vary from state to state.

To Receive Warranty Service

To locate an authorized service company in your area contact the Maytag dealer from whom your appliance was purchased; or call Maytag Appliances Sales Company, Maytag Customer Assistance at the number listed below. Should you not receive satisfactory warranty service, please call or write:

Maytag Appliances Sales Company

Attn: CAIR® Center

P.O. Box 2370

Cleveland, TN 37320-2370

U.S. or Canada (toll-free) 1-888-462-9824

U.S. customers using TTY for deaf, hearing impaired or speech impaired, call 1-800-688-2080.

When contacting Maytag Appliances Sales Company, Maytag Customer Assistance about a service problem, please include the following:

- (a) Your name, address and telephone number;
- (b) Model number and serial number (found on the back of the control panel) of your appliance;
- (c) Name and address of your dealer and the date the appliance was purchased;
- (d) A clear description of the problem you are having.
- (e) Proof of purchase.

What is not covered by these warranties:

1. Conditions and damages resulting from any of the following:
 - a. Improper installation, delivery, or maintenance.
 - b. Any repair, modification, alteration or adjustment not authorized by the manufacturer or an authorized servicer.
 - c. Misuse, abuse, accidents, or unreasonable use.
 - d. Incorrect electric current, voltage or supply.
 - e. Improper setting of any control.
 2. Warranties are void if the original serial numbers have been removed, altered, or cannot be readily determined.
 3. Light bulb
 4. Products purchased for commercial or industrial use.
 5. The cost of service or service call to:
 - a. Correct installation errors.
 - b. Instruct the user on proper use of the product.
 - c. Transport the appliance to the servicer.
 6. Consequential or incidental damages sustained by any person as a result of any breach of these warranties.
- Some states do not allow the exclusion or limitation of consequential or incidental damages, so the above exclusion may not apply.

User's Guides, service manuals and parts catalogs are available from Maytag Appliances Sales Company, Maytag Customer Assistance.

Maytag • 403 West Fourth Street North • P. O. Box 39 • Newton, Iowa 50208