

CVC4SS

Manual for Installation, Use and Maintenance

|C|D|A|



Important

The CDA Group Ltd cannot be held responsible for injuries or losses caused by incorrect use or installation of this product. Please note that CDA reserve the right to invalidate the guarantee supplied with this product following incorrect installation or misuse of the appliance.

Under no circumstances should any external covers be removed for servicing or maintenance except by suitably qualified personnel.

Appliance information:

Please enter the details on the appliance rating plate below for reference, to assist CDA Customer Care in the event of a fault with your appliance and to register your appliance for guarantee purposes.

Appliance Model

Serial Number

CE Declarations of Conformity:

This appliance has been designed, constructed and marketed in compliance with safety requirements of EEC Directive 2006/95/EEC (Low voltage) and requirements of EMC Directive 2004/108/EEC.

This appliance has been manufactured to the strictest standards and complies with all applicable legislation, including Electrical safety (LVD) and Electromagnetic interference compatibility (EMC). Parts intended to come into contact with food conform to EEC/89/109.4

IMPORTANT INFORMATION FOR CORRECT DISPOSAL OF THE PRODUCT IN ACCORDANCE WITH EC DIRECTIVE 2002/96/EC.

At the end of its working life, the product must not be disposed of as urban waste. It must be taken to a special local authority differentiated waste collection centre or to a dealer providing this service.

Disposing of a household appliance separately avoids possible negative consequences for the environment and health deriving from inappropriate disposal and enables the constituent materials to be recovered to obtain significant savings in energy and resources. As a reminder of the need to dispose of household appliances separately, the product is marked with a crossed-out wheeled dustbin. 

Please note:

This appliance is designed solely to produce coffee, hot water and steam. Other types of use are not permitted and may prove dangerous. The CDA Group Ltd will not be held liable for any damage caused by incorrect use of the appliance

- Read all instructions thoroughly before use.
- To protect against fire, electrical shock and injury to persons do not immerse cord or plugs in water or other liquid.
- The use of accessory attachments not recommended by The CDA Group Ltd may result in fire, electric shock or injury.

Coffee machine

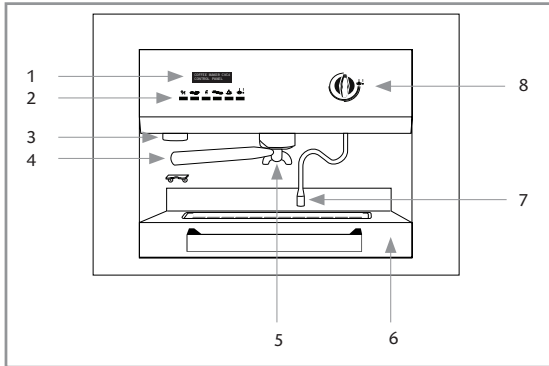

1. Display
2. Control panel
3. Grinder spout
4. Filter handle
5. Dispenser spout
6. Drip tray drawer
7. Steam / Water Nozzle
8. Steam / Water Valve

Control panel

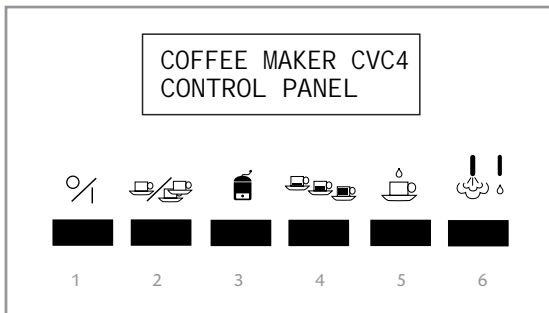

1. Power Button – Press to turn the machine on and off. (Standby)
2. Number Cups – Press to select between 1 and 2 cups.
3. Grind Button – Press once to start the grinding operation.
4. Coffee Size Button – Press to select between short, medium and long options.
5. Make Coffee Button – Press to begin the coffee making process.
6. Steam / Water Button – Press to alternate between water and steam functions.

First use

This coffee machine has two water heaters, one for the water and one for the coffee, which allows for ideal temperatures for coffee, hot water for tea and steam for cappuccino. The hot water or steam can also be used to preheat the cups.

This coffee machine can grind coffee beans when they are needed, ensuring they are freshly ground for the very best flavour.

To stop the coffee machine dispensing – if less than the preset amount is required – simply press  at any point when the coffee is dispensing.

The grinding level of the coffee beans can be adjusted depending on personal preference to either a coarser or finer grind.

Before first use:

1. Pull the machine out of its housing by lifting the handle of the machine and pulling it towards you.
2. Fill the water tank (if the coffee machine is not to be plumbed in to the mains water supply) and the coffee container (as described below).
3. Turn on the machine at the switch on the top left side of the machine.
4. Push the machine back into the housing.
5. Switch on the machine by pressing .
6. Turn the steam control knob and dispense a cup of hot water through the steam nozzle.
7. The machine is now ready for use.

The water tank

It is possible to use the coffee machine without connecting it to the mains water supply. There is an integral water tank which can be used in this instance. To ensure the best results from your coffee, it is recommended that the water tank be emptied frequently and refilled with fresh water, and no water be left in the tank for long periods.

When the water tank is empty, the message WATER LOW will show on the display.

To fill the water tank:

1. Pull the machine out of its housing by lifting the handle of the machine and pulling it towards you.
2. Open the lid of the water tank and fill it until the water is 4cm from the top level. Then close the lid.
3. Push the machine back into the housing.

Please note:

You should only use cold drinking water in this coffee machine, with water hardness level less than 7F.

The water tank can be removed for cleaning, following the steps above, and then lifting it out of the machine.

The coffee container

You should use only beans for espresso coffee in this machine. Other substances, such as ground coffee, instant coffee, beans treated with caramel, sugar or similar substances should not be used as they can damage the grinder or machine.

When the coffee container is empty, the message COFFEE LOW will show on the display.

To fill the coffee container:

1. Pull the machine out of its housing by lifting the handle of the machine and pulling it towards you.
2. Remove the lid of the coffee container and fill it until the coffee beans are 2cm from the top level. Then replace the lid.
3. Push the machine back into the housing.

Setting/Adjusting the grind

1. Pull the machine out of its housing by lifting the handle of the machine and pulling it towards you.
2. Carefully turn the control knob located on the left side of the coffee machine three complete turns either clockwise for a finer grind, or anti-clockwise for a coarser grind.
3. Push the machine back into the housing.
4. Dispense two coffees.

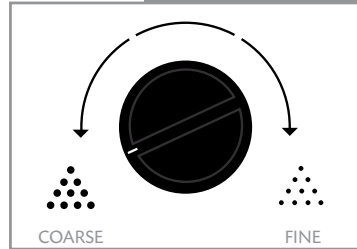

Please note:

You must dispense at least two coffees after adjusting the grind before making any further adjustments.

The Coffee Machine

Press  to switch on the coffee machine

After a few seconds, HELLO will show on the display.

The machine will heat up, and COFFEE and WATER will flash on the display. Once the machine is ready for use, COFFEE and WATER will illuminate constantly, as will the size and number of the coffees last selected (for example 1 SHORT). If COFFEE continues to flash, add coffee beans to the container. If WATER continues to flash (non-mains plumbed coffee machines only) add water to the water tank.

Making an espresso coffee

1. Select the number of coffee cups

The coffee machine can prepare one or two cups of coffee simultaneously.

To select the number required, press  until the required number of coffees shows on the display.

2. Grind the coffee

Put the filter handle on the grinder spout and press . The grinder will grind the set amount of coffee beans.

3. Select the coffee size

The coffee machine is equipped with three preset coffee size.



To select the size required, press  to select from the following options:

SHORT - 52ml



NORMAL - 67ml

LONG - 145ml

It is possible to adjust the amount of coffee dispensed. To do so follow the steps below.

1. When the coffee is being made, press  until the required amount has been dispensed.
2. The display will show MEMO?
3. Press  to select the size that is to be set.
4. Press and hold  to confirm the setting. The coffee machine will beep.

4. Make the coffee

1. After grinding the coffee, place the filter handle on the dispenser spout.
2. Place the cup or cups under the dispenser spout.
3. Press  to start dispensing. The coffee machine will dispense the selected amount of coffee. To stop the coffee machine dispensing before the end of the preset programme, press  again.

Dispensing hot water or steam

1. Press  to select either hot water or steam and wait for the display to stop flashing.
2. Place the cup or container under the steam nozzle.
3. Turn the control knob anti-clockwise to dispense the hot water, turning it back once the required amount has been dispensed.

Please note:

Ensure that the spout is placed in a cup or container before turning the control knob, as hot steam can cause scalding.

Always use the handle to move the water spout.

Make a cappuccino

We recommend preparing cappuccinos individually so as to ensure best flavour.

1. Make a medium espresso as described above in a large cup.
2. Press  to select steam and wait until STEAM stops flashing.
3. Before putting the container under the steam nozzle, turn the control knob clockwise to flush out any water remaining in the pipes.
4. Fill a 50cl stainless steel container with 10cl milk.
5. Put the steam nozzle into the container so it is at the bottom of the container.
6. Turn the control knob clockwise to steam the milk for a few seconds. Do not heat the milk excessively as this will prevent froth from forming.
7. After a few seconds, lower the container so the steam nozzle is on the surface of the milk and continue to steam until sufficient froth is obtained. Then turn the control knob to switch off the steam.
8. Slowly pour the frothed milk onto the coffee.

Please note:







The coffee machine will store in memory which of water/steam functions has been used previously and will automatically return to this option the next time it is used.

Tea bags and coffee pods can be used in the filter handle to allow other drinks to be prepared.

Programming

The coffee machine is equipped with a programming mode to enable you to set the following as required:

To enter programming mode follow the steps below:

- 1 Whilst the machine is off, press and hold  until PROGRAMMING shows on the display
2. Press  or  to cycle through the programme options until the required programme shows on the display.
3. To change a setting, press  or  until the required setting shows on the display.
4. Press  to exit programming mode.

Programming options are:

CLOCK – allows you to set the clock.

AUTO ON – allows you to set the time the coffee machine will switch on automatically.

Please note: To set the coffee machine to automatically switch on, you must press  when the coffee machine is switched off. The display will show an * next to the time when the coffee machine is off to indicate the Automatic Switch on is set..

AUTO OFF – allows you to set the time the coffee machine will switch off automatically.

Please note: To set the coffee machine to automatically switch off, you must press  when the coffee machine is switched off. The display will show an * next to the time when the coffee machine is off to indicate the Automatic off is set..

AUTO SHUT DOWN – allows you to set the number of minutes the coffee machine will be on before switching off automatically. The options are 15, 30, 45, 60, 75, 90, or 0 for off.

POWER SAVING – allows you to set the length of time after which the coffee machine reduces the temperature of the water heater to lower consumption. The options are 15, 30, 45, 60, 75, 90, or 0 for off.

DISPLAY – allows you to set the language on the display. The options are English, Italian, French, Spanish, Portuguese, German or Dutch.

WATER HARDNESS – allows you to set the hardness of the water used. To find out the water hardness in your area, you should contact your water supplier. The options are 0, 5, 10, 15, 20, 25dh. 1dh = 1.786F = 1.25e = 17.86ppm = 0.1786mmol/l)

DESCALING – shows the number of litres of water that have been dispensed and the theoretical level of limescale build up based on the water hardness programmed. 100% indicates that descaling needs to be carried out. This number will reset after descaling.

COFFEE – shows the number of coffees made since first use. This number cannot be reset.

GROUND COFFEE – allows you to set the quantity of ground coffee to make the coffee stronger or weaker. The selection ranges from -5 to +5 (0.1 sec) – the coffee will be stronger the higher the number and 0 corresponds to the preset factory level.

COFFEE TEMPERATURE – allows you to set the temperature for coffee. The selection ranges from -10C to +10C and 0 corresponds to the preset factory level.

WATER TEMPERATURE – allows you to set the temperature for hot water. The selection ranges from -10C to +10C and 0 corresponds to the preset factory level.

STEAM TEMPERATURE – allows you to set the temperature for steam. The selection ranges from -10C to +10C and 0 corresponds to the preset factory level.



Care and Maintenance

DO NOT PERFORM ANY MAINTENANCE OR CLEANING WITHOUT FIRST ISOLATING THE MAINS ELECTRICAL SUPPLY.

THE COFFEE MACHINE WILL BE HOT IMMEDIATELY AFTER USE. ALLOW IT TO COOL BEFORE CLEANING.

As the coffee machine has a stainless steel and glass surface, you should use a nonabrasive cleaner. Any abrasive cleaner (including Cif) will scratch the surface and could erase the control panel markings. Stainless steel can be effectively cleaned by simply using a dilute solution of water and mild detergent and drying to a shine with a clean cloth.

Remove the drip tray grid and the inner tray from the drip tray drawer and the water tank. These can be cleaned with a soft sponge and sanitising detergent solution.

The steam/water spout can be unscrewed and removed for cleaning. This should be cleaned with a soft sponge and hot water, or can be placed in a dishwasher. After frothing milk, it is advisable to flush the spout by dispensing a small amount of water or steam to remove any residues of milk or froth.

IMPORTANT:

Steam cleaners must not be used when cleaning this appliance.
Ensure that all parts are correctly replaced after cleaning.

Care and Maintenance

Descaling

If the display shows DESCALING then the coffee machine needs to be descaled to ensure best performance.









Please note:

You should use cleaning products that are appropriate for use with coffee machines.

Do not use lemon-based products to descale the coffee machine as these can cause irreparable damage to the coffee machine.

Failure to descale your coffee machine constitutes misuse and may invalidate your guarantee.

To descale the coffee machine, follow the steps below:

1. If the coffee machine is plumbed into the mains water supply, turn off the tap.
2. Open the drip tray drawer and remove the drip tray grid.
3. Remove any water from the drip tray and coffee grounds from the container. Then close the drip tray drawer without replacing the grid.
4. Position the steam nozzle so that any water drips into the drip tray.
5. Switch on the coffee machine and wait until the WATER and STEAM have stopped flashing.
6. Switch off the coffee machine.
7. Press and hold  until PROGRAMMING shows on the display.
8. Select the descaling function by pressing  or  until DESCALING shows on the display.
9. Press and hold  and  together and then press  until the coffee machine beeps.
10. When DESCALING STAGE 01 shows on the display, fill the tank half full with descaling product, then press .
11. When DESCALING STAGE 02 shows on the display, open the steam nozzle.
12. When DESCALING STAGE 03 shows on the display, the coffee machine will dispense water from both the coffee dispenser and steam nozzle.
13. When DESCALING STAGE 04 shows on the display, refill the water tank with fresh water, then press .
14. When DESCALING STAGE 05 shows on the display, the coffee machine will start the cleaning cycle.
15. Turn the control knob to close the steam nozzle.
16. Fill the water tank and wait for the coffee machine to confirm both coffee and water temperatures have been reached.

Your coffee machine is now descaled and ready for normal use.

IMPORTANT: if the coffee machine is plumbed into the mains water supply, it must be installed with a mains water isolation valve and 150 micron filter.

Troubleshooting

The coffee machine does not switch on	The machine is not fully back in its housing.	Push the coffee machine back fully.
	There is a problem with the electricity supply.	Check that the mains supply has not been switched off. Check that the fuse in the spur has not blown.
The coffee will not dispense or dispenses only in slow drips	The coffee grind is too fine.	Adjust the grind to be coarser.
	There is not enough water in the water tank	Fill the water tank or check there is no fault with the mains water supply.
	The internal pipes are obstructed	
The coffee dispenses too fast and is not creamy	The coffee grind is too coarse.	Adjust the grind to be finer.
	The coffee is too old	Replace the coffee beans with fresh beans
	Coffee blend	Change the coffee beans for those appropriate for use.
The pump makes a loud noise when dispensing coffee	There is not enough water in the water tank (non-mains water supply only)	Fill the water tank or check there is no fault with the mains water supply.
	The coffee grind is too coarse so the pressure in the filter holder is too low.	Adjust the grind to be finer.
Milk froth does not form		Check the flow of steam is suitable

The coffee machine is equipped with an auto-diagnostic system to recognise and advise on how to deal with faults. These alerts will show on the display.

Machine on/off	Display shows	Solution
OFF	CLOSE TAP	Close the steam control knob
OFF	DESCALING	Descale the coffee machine
ON	TECHNICAL SERVICE	Before calling CDA Customer Care, first try pulling the coffee machine out and pushing it back in fully.
ON	WATER PRESSURE	Check the water tank is full and then open the water dispensing tap, letting water out of the steam nozzle until the display stops flashing. This allows the system to refill.
ON	GRINDER	Check the grinder for any foreign bodies (e.g. stones or impurities). Fully turn the grind adjustment control knob anti-clockwise then remove any impurities by running the grinder for a few seconds. Once this is complete, return the grind adjustment control knob to its previous position.

Installation

IMPORTANT: THIS APPLIANCE SHOULD BE FITTED BY A SUITABLY QUALIFIED PERSON. WE RECOMMEND THAT YOU SEEK THE HELP OF ANOTHER INDIVIDUAL WHEN INSTALLING THIS PRODUCT

1. Slide the base unit into the housing ensuring the dimensions are correct as per figure 1.
2. Fix the base unit in place by attaching the 10 screws in to the holes as shown in figure 2 and figure 3. If the sides of the base are not flush with the sides of the housing, then use the shims provided.
3. Push the runners fully closed on the base unit.
4. Connect the plug to the plug socket. This must be accessible after the appliance has been installed.
5. Using an appropriate supply pipe, connect one end of the hose to the threaded inlet of the valve on the dispenser, located at the rear of the appliance.
6. Insert the flow restrictor between two rubber washers, then connect the other end of the pipe to the mains water supply (drinking water only)
7. Insert the appliance into the housing, ensuring that the runners on the machine are located in the runners on the base unit. Then slide the appliance fully into the housing.

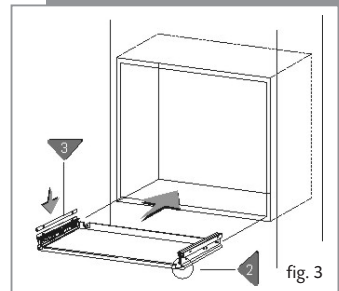
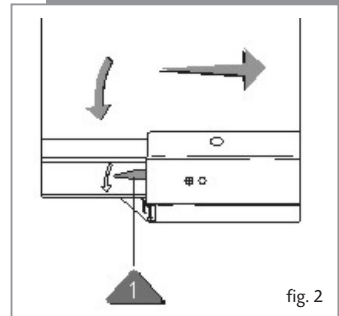
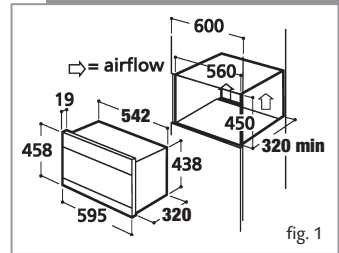

Installation

Please note:

Due to the weight of this appliance, the furniture unit must be secured to the wall prior to installation.

You must ensure that all water connections are sound and check there are no leaks before completing installation.

For best performance, the mains water pressure must be between 0.1 - 3 bar.

Do not use outdoors.

To reduce the risk of electric shock, do not mount over a sink.

The water supply should be located in a place that allows the machine to be isolated in the event of an emergency.

CDA will not be held responsible for water leaks caused by incorrect installation.

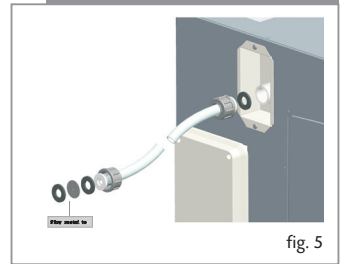
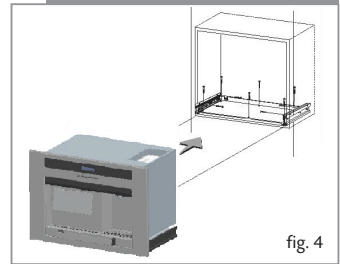

Electrical information

Warning! This appliance must be earthed.

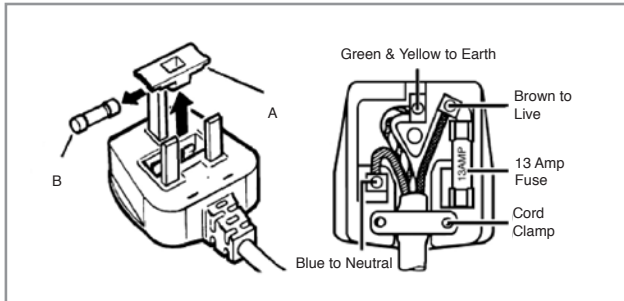

The mains lead of this appliance has been fitted with a BS 1363A 13 amp fused plug. To change a fuse in this type of plug, follow the steps below:

1. Remove the fuse cover and fuse.
2. Fit replacement 13A fuse, ASTA approved to BS 1362 type, into the fuse cover.
3. Replace fuse cover.

Important: Do not use the appliance without the fuse cover in position.

How to connect an alternative plug

If the fitted plug is not suitable for your socket outlet, then it should be cut off and disposed of safely to avoid the risk of electric shock. A suitable alternative plug of at least 13 Amp rating to BS 1363 should be used.

As the colours of the wires in the mains lead of this appliance may not correspond with the coloured markings identifying the terminals in your plug, proceed as follows:-

- The wire which is coloured GREEN and YELLOW must be connected to the terminal which is marked with letter (E) or by the Earth symbol \perp or coloured GREEN and YELLOW.
- The wire which is coloured BLUE must be connected to the terminal which is marked with the letter (N), or coloured BLACK.
- The wire which is coloured BROWN must be connected to the terminal which is marked with the letter (L) or coloured RED or BROWN.

If in doubt regarding the electrical connection of this appliance, consult a qualified electrician. Do not shorten the supply cable, the appliance may require removing for servicing.

N.B. Ensure that the plug socket is situated in an easily accessible place so that it can be isolated from the mains electrical supply after installation.





To contact our Customer Care Department, or for Service,
please contact us on the details below.