

TIMEX[®]

Model T236

***Jumbo Display
AM/FM Clock Radio***



For additional information, online registration,
and exclusive special offers visit our website:

www.timexaudio.com

Questions? Contact Customer Service at 1-800-888-4491

Table of Contents

What's in the Box.....	1
Product Care	1
Controls Overview	2
Display.....	3
Set Up	3
Adjusting the Time Zone.....	4
Setting the Clock	5-7
Setting and Using Alarms	8-10
Setting and Using the Radio.....	10-12
Using in Aux-in Audio	12-13
Sleep Mode	13
Dimmer.....	13
Charging Devices Using the USB Port.....	14
Battery Information	14
Installing and Replacing Backup Batteries	15
Safety Information	16
Troubleshooting.....	17
Warranty Information	18

What's in the Box

This product ships with the following items. Make sure all are present.



1. T236 Alarm Clock



2. AC adaptor

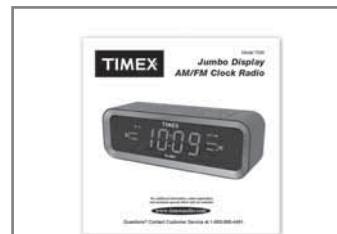

3. Instruction book

Product Care

- Place the unit on a level surface away from sources of direct sunlight or excessive heat.
- Protect your furniture when placing your unit on a natural wood and lacquered finish. A cloth or other protective material should be placed between it and the furniture.
- Clean your unit with a soft cloth moistened only with mild soap and water. Stronger cleaning agents, such as Benzene, thinner or similar materials can damage the surface of the unit.

Controls Overview

Top Panel

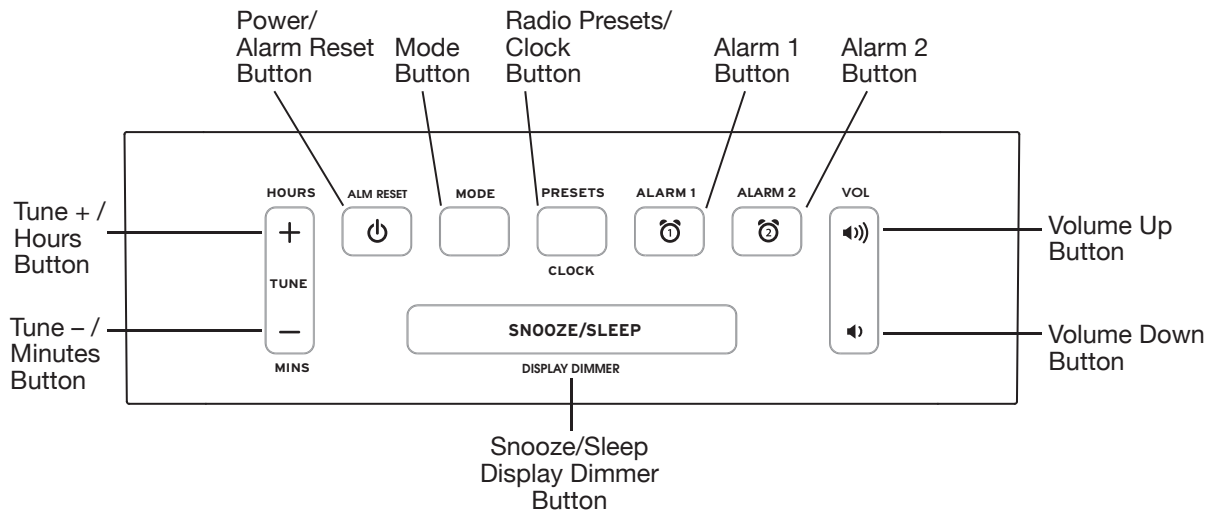

Rear Panel

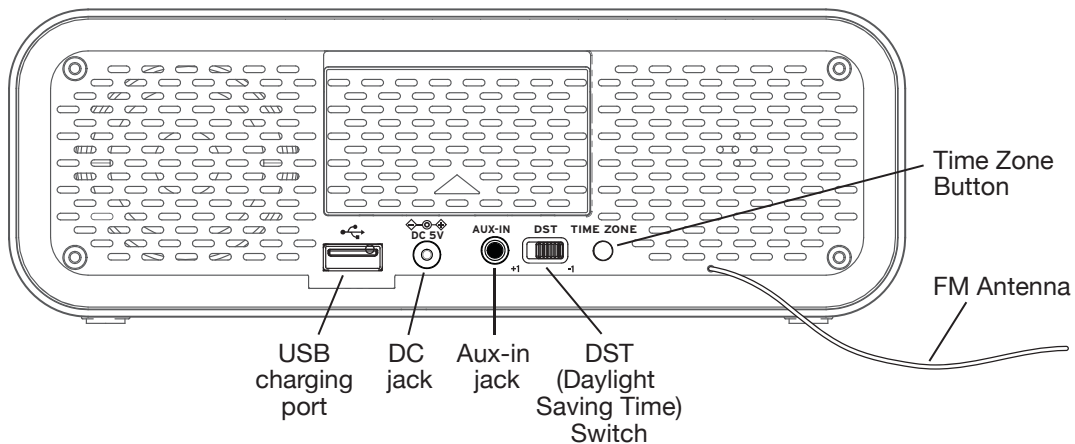

Display

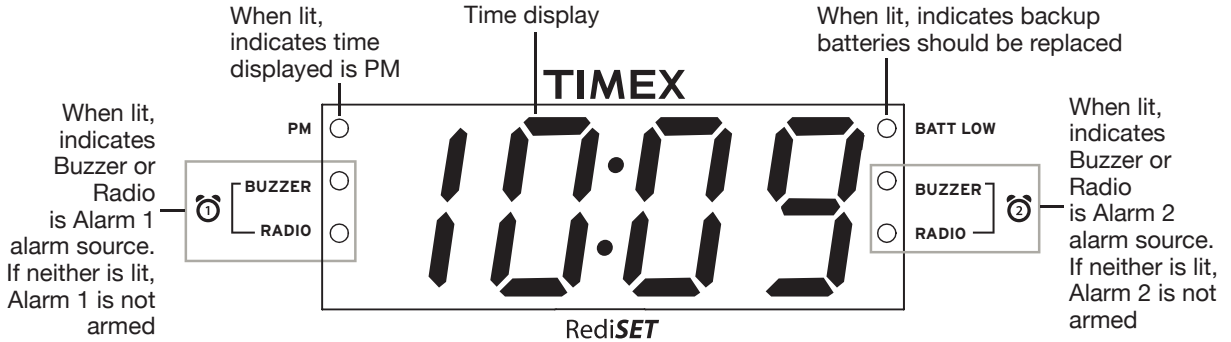

Set Up

Connecting to Power Source

Connect the AC adaptor to the DC jack located on back of the unit. Connect plug into a working wall outlet that is not controlled by a wall switch. **The unit does not operate on batteries** (the battery backup system maintains clock settings during power failures).

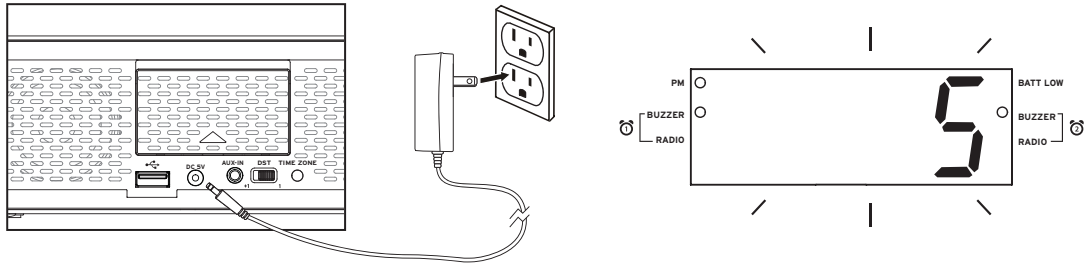

Redi-SET

This unit has a Redi-SET™ clock feature. When connected to power, the display begins counting down 5-4-3-2-1, then the year flashes, followed by the month/date and then the time. By default, the unit sets itself to Eastern Standard Time. If Daylight Saving Time is in effect slide the DST switch on the back panel to the "+1" position to move the display ahead by one hour. If you live in a different time zone refer to the Time Zone Adjustment procedure on page 4. You only need to adjust the Time Zone once and your new zone setting becomes the new default.

Adjusting the Time Zone

1

TIME ZONE

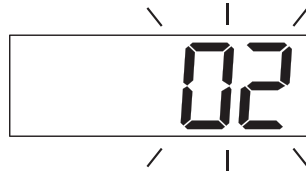

If you are NOT in the Eastern time zone, *press and hold* the **Time Zone Button** located on back of the unit. “02” will flash in the display.

01—Atlantic Time

02—Eastern Time (Default Setting)

03—Central Time

04—Mountain Time

05—Pacific Time

06—Yukon Time

07—Hawaiian Time

2

HOURS



MINS

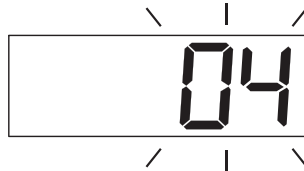

Find the number that matches your time zone above.

Press and release the **TUNE+/HOURS Button** or **TUNE-/MINS Button** until that number appears on the display.

3

TIME ZONE



Press and release the **Time Zone Button** to confirm time zone setting.

Setting the Clock

This unit features Redi-SET and should display the correct time when first connected to power. If the time is not correct, follow these steps to set the clock manually.

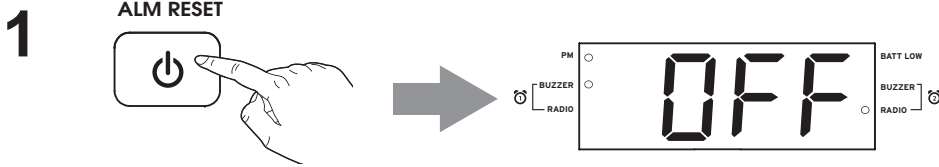

Make sure unit is OFF. To confirm unit is off, press and release the **Power/Alarm Reset Button** once or twice until OFF appears in the display.

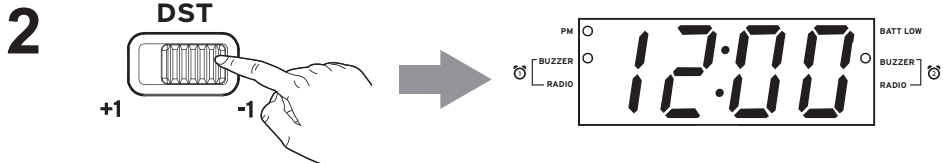

For quick adjustment for Daylight Saving Time, slide the **DST Switch** on the back of the unit to +1 to add an hour. For Standard Time slide switch to -1 to subtract an hour.

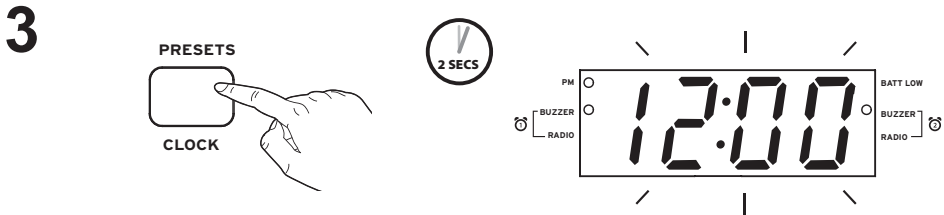

Press and hold the **Presets/Clock Button** until the time flashes on the display.

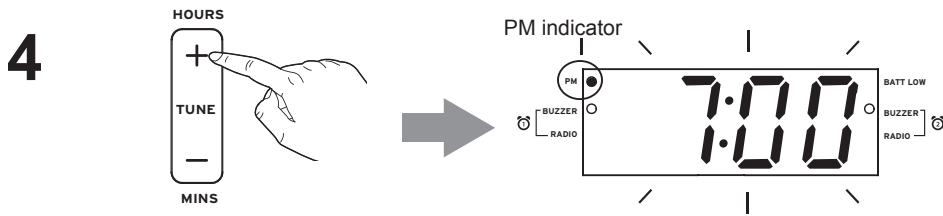

Press and release the **Tune +/HOURS Button** to adjust the HOUR.

NOTE: The PM indicator will light when the hour is set for PM. There is no AM indicator.

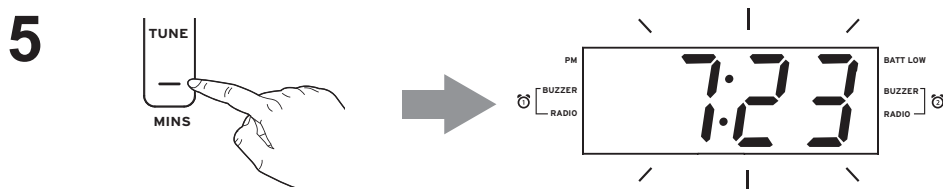

Press and release the **Tune -/MINS Button** to adjust the MINUTES.

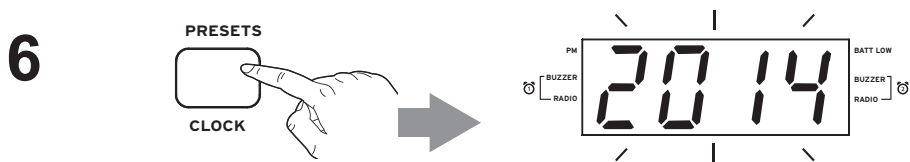

Press and release the **Presets/Clock Button**. The YEAR flashes on the display

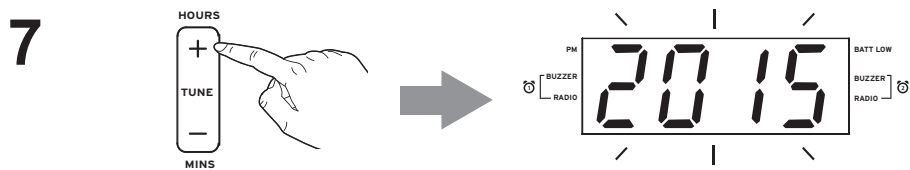

Press and release the **Tune +/HOURS or Tune -/MIN Button** to adjust the YEAR.

8

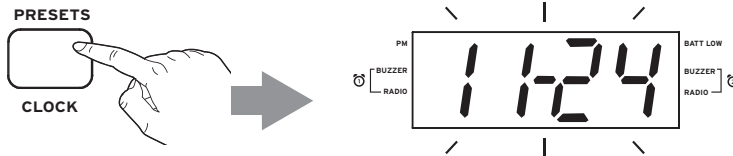

Press and release the **Presets/Clock Button**. The MONTH and DATE flash on the display.

9

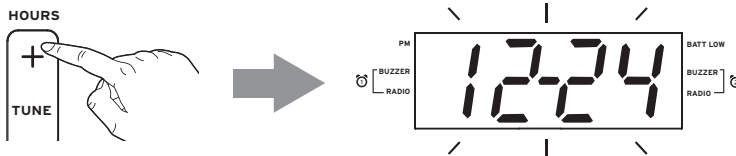

Press and release the **TUNE+/HOURS Button** to adjust the MONTH.

10

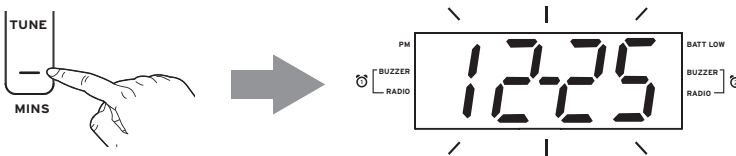

Press and release the **TUNE -/MINS Button** to adjust the DATE.

11

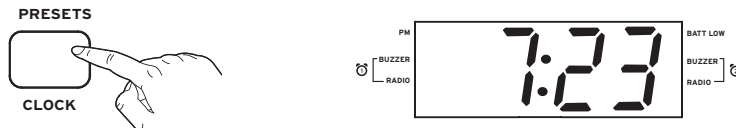

Press and release the **Presets/Clock Button** to complete time setting.

NOTE: To view current year and month/date, press the **Mode Button** when unit is OFF.

Setting and Using Alarms

This unit has two independent alarms, Alarm 1 and Alarm 2. Each is set and operates in the same way. Instructions below show Alarm 1. Follow the same method to set Alarm 2.

1

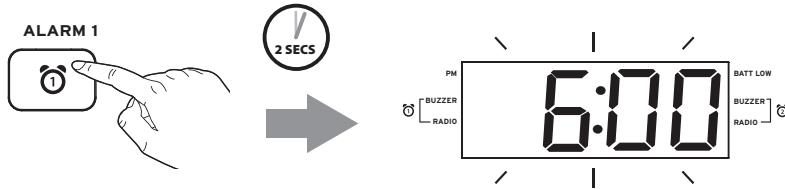

Press and hold the **Alarm 1 Button** until current alarm time flashes on the display.

2

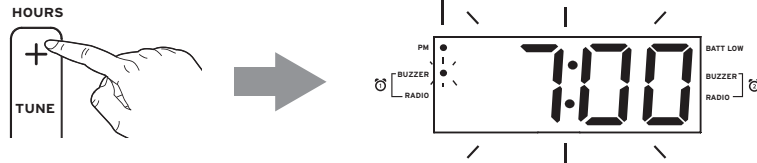

Press and release the **TUNE+/HOURS Button** to adjust the HOUR.

NOTE: The PM indicator will light when the hour is set for PM. There is no AM indicator.

3

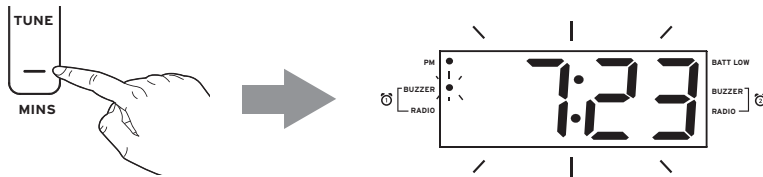

Press and release the **TUNE -/MINS Button** to adjust the MINUTES.

4

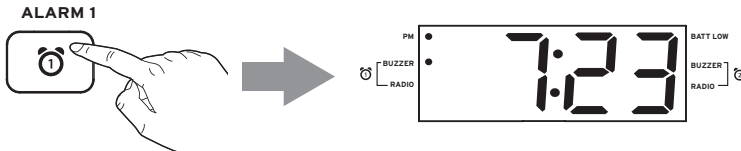

Press and release the **Alarm 1 Button** to complete alarm time setting.

SELECTING YOUR ALARM SOURCE/DISARMING THE ALARM

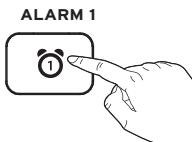

Set alarm to Buzzer



Alarm set to Buzzer

Set alarm to Radio



Alarm set to Radio

Disarm alarm



Alarm OFF
(no indicator)

Press and release the **Alarm 1 Button** repeatedly as needed to cycle to desired alarm mode: **Buzzer** (default), **Radio** (last AM or FM station played) or **Off** (alarm is no longer active). Note that the last radio volume listened to will be the radio alarm volume.

RESETTING AN ALARM TO COME ON THE NEXT DAY

ALM RESET



OR

ALARM 1



OR

ALARM 2



To silence any sounding alarm and reset it come on the next day at the same time, press and release either the **Power/Alarm Reset Button**, **Alarm 1 Button** or **Alarm 2 Button**.

SNOOZE



Press and release the **Snooze/Sleep Button** when the alarm sounds to silence it for 9 minutes. Snooze can be used several times during 1 hour alarm cycle.

Setting and Using the Radio

BASIC RADIO OPERATION

TIP: Extend FM antenna for best reception.

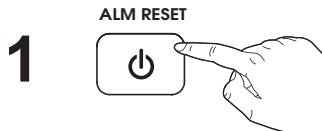

Press and release the **Power/Alarm Reset Button** to turn unit On.

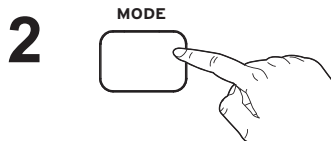

AM

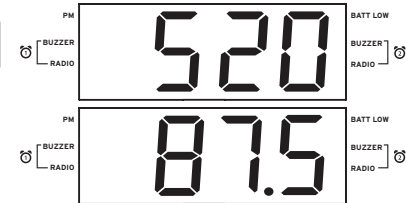

FM

Press and release the **Mode Button** as needed to select AM or FM radio band.

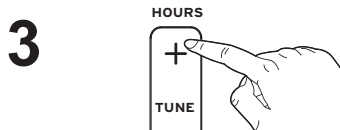

OR

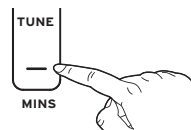

Press and release the **TUNE+ / HOURS Button** or **TUNE - / MIN Button** to tune radio to a desired station. *Press and hold* to seek the next clear station.

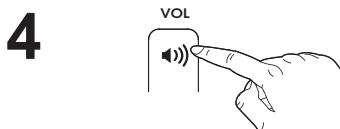

OR



Press and release the **Volume - Button** or **Volume + Button** to adjust radio volume.

PRESET RADIO SETTING AND OPERATION

SETTING RADIO PRESETS

This unit will store up to 20 station presets, 10 AM and 10 FM.

1



Press and release the **Power/Alarm Reset Button** to turn unit On.

2

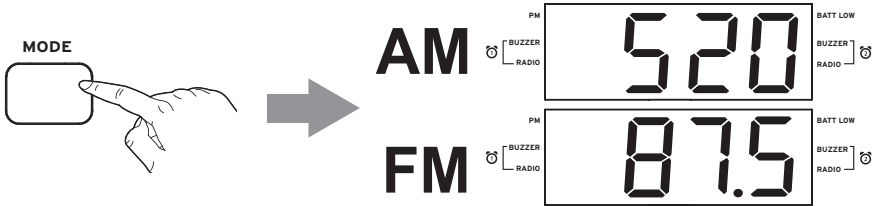

Press and release the **Mode Button** as needed to select AM or FM radio band.

3



Press and release the **TUNE+/HOURS Button** or **TUNE - /MIN Button** to tune radio to a station you want to assign to a preset. *Press and hold* to seek the next clear station.

4

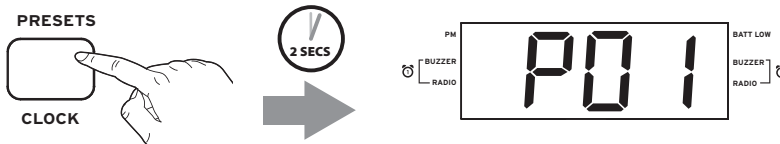

Press and hold the **Presets/Clock Button** to enter presetting mode.

5



Press and release the **TUNE+/HOURS Button** or **TUNE - /MIN Button** to select the preset number you wish to assign (P01 -P10).

6

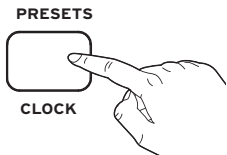

Press and release the **Presets/Clock Button** to confirm the preset number (P01 - P10) you want to assign to the current station. Continue steps 2- 6 to set all desired presets.

PRESET RADIO OPERATION

To listen to a preset at any time, press and release the **Presets/Clock Button** as needed to select the desired preset station.

Using Aux In Audio

1

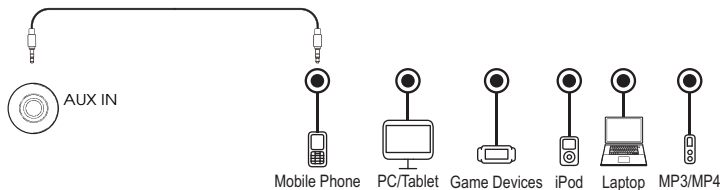

Connect a standard audio cable with 3.5mm plug (not included) to the AUX IN jack located on the back of the unit and to the output/headphone jack of your audio device.

2



Press and release the **Power/Alarm Reset Button** to turn unit On.

3

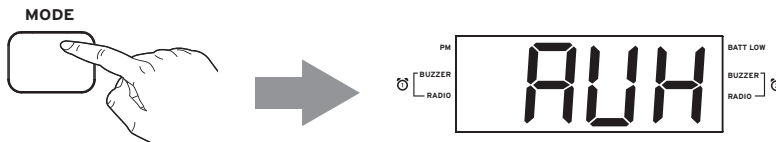

Press and release the **Mode Button** as needed to select AUX mode.

4

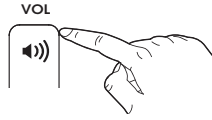

OR

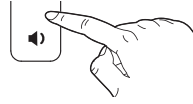

Control audio playback on your device, making sure output volume is turned up. If needed, press the **Volume - Button** or **Volume + Button** to adjust volume on the unit.

Sleep Mode

Sleep mode allows you to set the unit to turn off after a selected time interval. It allows you to fall asleep while listening to the radio or a device that is connected to the Aux In Jack.

NOTE: It will power off the Timex unit, but it will not power off your AUX device.



Press and release the **Snooze/Sleep Button** in AM/FM or AUX mode to select the desired sleep interval: 90, 80, 70, 60, 50, 40, 30, 20, 10 minutes or OFF (turns unit off right away).

Dimmer



*Press and hold the **Snooze/Sleep Button** to toggle display brightness between high and low settings. Dimmer cannot be adjusted when alarm is sounding.*

Installing and Replacing Backup Batteries

Your new Timex Clock Radio includes 2 AA batteries (installed). This battery backup system will maintain the time and alarm settings during a temporary power interruption. When the Battery Low Indicator on the top left of the display is lit, it's time to replace the batteries.

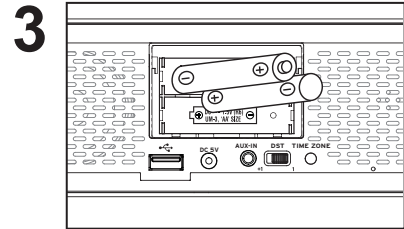
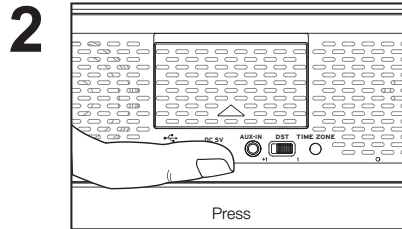
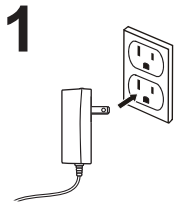

1. Keep unit connected to AC power when changing batteries to avoid losing your settings.
2. Slide the battery door to release then open and remove the battery door.
3. Install 2 fresh “AA” batteries. Check and match the correct polarity (+/ -) markings in the battery compartment.
4. Replace the battery door.

NOTE: With batteries installed, the display will turn off during a power failure but the clock will continue to run and maintain your alarm settings and the alarm will sound.

IMPORTANT SAFETY INSTRUCTIONS

When used in the directed manner, this unit has been designed and manufactured to ensure your personal safety. However, improper use can result in potential electrical shock or fire hazards. Please read all safety and operating instructions carefully before installation and use, and keep these instructions handy for future reference. Take special note of all warnings listed in these instructions and on the unit.

1. **Water and Moisture** – The unit should not be used near water. For example: near a bathtub, washbowl, kitchen sink, laundry tub, swimming pool or in a wet basement.
2. **Ventilation** – The unit should be situated so that its location or position does not interfere with its proper ventilation. For example, it should not be situated on a bed, sofa, rug or similar surface that may block ventilation openings. Also, it should not be placed in a built-in installation, such as a bookcase or cabinet, which may impede the flow of air through the ventilation openings.
3. **Heat** – The unit should be situated away from heat sources such as radiators, heat registers, stoves or other appliances (including amplifiers) that produce heat.
4. **Power Sources** – The unit should be connected to a power supply only of the type described in the operating instructions or as marked on the appliance.
5. **Power-Cable Protection** – Power supply cables should be routed so that they are not likely to be walked on or pinched by items placed upon or against them. It is always best to have a clear area from where the cable exits the unit to where it is plugged into an AC socket.
6. **Cleaning** – The unit should be cleaned only as recommended. See the Maintenance section of this manual for cleaning instructions.
7. **Objects and Liquid Entry** – Care should be taken so that objects do not fall and liquids are not spilled into any openings or vents located on the product.
8. **Attachments** – Do not use attachments not recommended by the product manufacturer.
9. **Lightning and Power Surge Protection** – Unplug the unit from the wall socket and disconnect the antenna or cable system during a lightning storm or when it is left unattended and unused for long periods of time. This will prevent damage to the product due to lightning and power-line surges.
10. **Overloading** – Do not overload wall sockets, extension cords, or integral convenience receptacles as this can result in a risk of fire or electric shock.
11. **Damage Requiring Service** – The unit should be serviced by qualified service personnel when:
 - A. the power supply cable or plug has been damaged.
 - B. objects have fallen into or liquid has been spilled into the enclosure.
 - C. the unit has been exposed to rain.
 - D. the unit has been dropped or the enclosure damaged.
 - E. the unit exhibits a marked change in performance or does not operate normally.
12. **Antenna** – Do not connect an external antenna to the unit (other than that provided).
13. **Periods of Nonuse** – If the unit is to be left unused for an extended period of time, such as a month or longer, the power cable should be unplugged from the unit to prevent damage or corrosion.
14. **Servicing** – The user should not attempt to service the unit beyond those methods described in the user's operating instructions. Service methods not covered in the operating instructions should be referred to qualified service personnel.

Troubleshooting

1. **The unit does not power ON.**

The unit is not connected to AC outlet, the AC outlet has no power, or is controlled by a wall switch that is “OFF”.
Check AC outlet and wall switch.

2. **Alarm does not come on?**

The alarm time AM or PM incorrectly set, Alarm was OFF, etc. Check alarm settings.

3. **Low battery indicator is on.**

Batteries have not been installed correctly in the battery compartment or the batteries may be weak or exhausted. Try replacing batteries.

4. **Poor FM Radio reception on certain stations.**

Weak or distant station. Try adjusting the direction of the FM wire antenna.

5. **Poor AM Radio reception on certain stations.**

Weak or distant station. Rotate the unit to improve reception.

6. **USB port not charging devices.**

Unit is operating on batteries or is in AM radio mode. Make sure unit is powered by AC and not in AM radio mode.

7. **Unit shuts “Off” unexpectedly.**

The unit is in the Sleep Mode instead of the power ON mode, the unit was turned ON by an alarm and the alarm time ended, AC outlet unit is connected to is controlled by a wall switch that is turned OFF. Check mode on unit.
Check wall switch. Turn unit on with Power Button.

8. **Unit doesn’t respond (locked up or frozen).**

The unit may need to be reset. To do so, unplug the unit from power source and remove the backup batteries. Let unit stand for 2 minutes. Re-install backup batteries and connect unit to power source. You will need to reset the clock, radio and any other settings.

FCC Information

This device complies with Part 15 of the FCC Rules, operation is subject to the following two conditions: (1) This device may not cause harmful interference, and (2) this device must accept any interference received, including interference that may cause undesired operation.

- Warning: Changes or modifications to this unit not expressly approved by the party responsible for compliance could void the user’s authority to operate the equipment.
- NOTE: This equipment has been tested and found to comply with the limits for a Class B digital device, pursuant to Part 15 of the FCC Rules.

These limits are designed to provide reasonable protection against harmful interference in a residential installation. This equipment generates, uses and can radiate radio frequency energy and, if not installed and used in accordance with the instructions, may cause harmful interference to radio communications.

However, there is no guarantee that interference will not occur in a particular installation. If this equipment does cause harmful interference to radio or television reception, which can be determined by turning the equipment off and on, the user is encouraged to try to correct the interference by one or more of the following measures:

- Reorient or relocate the receiving antenna.
- Increase the separation between the equipment and receiver.
- Connect the equipment into an outlet on a circuit different from that to which the receiver is connected.
- Consult the dealer or an experienced radio/TV technician for help.

Limited 90 Day Warranty Information

Timex Audio Products, a division of SDI Technologies Inc. (hereafter referred to as SDI), warrants this product to be free from defects in workmanship and materials, under normal use and conditions, for a period of ninety (90) days from the date of original purchase.

Should this product fail to function in a satisfactory manner, it is best to first return it to the store where it was originally purchased. Should this fail to resolve the matter and service still be required by reason of any defect or malfunction during the warranty period, SDI will repair or, at its discretion, replace this product without charge. This decision is subject to verification of the defect or malfunction upon delivery of this product to the Factory Service Center authorized by Customer Service.

If service is required, please call Customer Service at 1-800-888-4491 for Return Authorization and shipping instructions.

Disclaimer of Warranty

NOTE: This warranty is valid only if the product is used for the purpose for which it was designed. It does not cover (i) products which have been damaged by negligence or willful actions, misuse or accident, or which have been modified or repaired by unauthorized persons; (ii) cracked or broken cabinets, or units damaged by excessive heat; (iii) damage to digital media players, CD's or tape cassettes (if applicable); (iv) the cost of shipping this product to the Factory Service Center and its return to the owner.

This warranty is valid only in the United States of America and does not extend to owners of the product other than to the original purchaser. In no event will SDI or any of its affiliates, contractors, resellers, their officers, directors, shareholders, members or agents be liable to you or any third party for any consequential or incidental damages, any lost profits, actual, exemplary or punitive damages. (Some states do not allow limitations on implied warranties or exclusion of consequential damages, so these restrictions may not apply to you.) This warranty gives you specific legal rights, and you may also have other rights which vary from state to state.

Your acknowledgment and agreement to fully and completely abide by the above mentioned disclaimer of warranty is contractually binding to you upon your transfer of currency (money order, cashier's check, or credit card) for purchase of your SDI product.

© 2015 SDI Technologies, Inc. All rights reserved
Questions? Visit www.timexaudio.com
or call 1-800-888-4491 Toll Free

TIMEX is a registered trademark of Timex Corporation in the United States and other countries