

Cat. No. 43-637  
**OWNER'S MANUAL**

Please read before using this equipment.

# ET-148

## 20-Number Memory Speakerphone with Privacy



**RadioShack®**

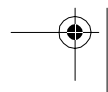
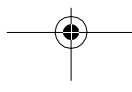



## FEATURES

---

Your RadioShack ET-148 20-Number Memory Speakerphone with Privacy is designed to exacting standards that ensure reliability, long life, and outstanding performance.

Its features include:

**20-Number Memory Dialing** — lets you store up to 15 digits in each of 20 memory locations for easy dialing.

**Built-In Speakerphone** — gives you hands-free operation.

**Ringer Switch** — lets you adjust the ringer's volume or turn it off.

**Pause** — lets you store a pause in a memory number.

**Privacy** — lets you temporarily turn off the speakerphone or handset microphone.

**Flash** — sends an electronic switch-hook signal for use with special phone services, such as Call Waiting.

**Tone/Pulse Dialing** — lets you use your phone with either type of service.

**Hearing-Aid Compatibility** — lets you use your phone with hearing aids that have a T (telephone) switch.

**Note:** Your telephone uses two AAA batteries (not supplied) for memory backup.

This telephone has been tested and found to comply with all applicable UL and FCC standards.

For your records, we recommend you record your telephone's serial number here. The number is on the bottom of the telephone.



Serial Number \_\_\_\_\_

© 1997, 1998 Tandy Corporation.

All Rights Reserved.

RadioShack is a registered trademark used by Tandy Corporation.

**WARNING:** To reduce the risk of fire or shock hazard, do not expose this product to rain or moisture.

	<b>CAUTION</b> RISK OF ELECTRIC SHOCK. DO NOT OPEN.	
<b>CAUTION:</b> TO REDUCE THE RISK OF ELECTRIC SHOCK, DO NOT REMOVE COVER OR BACK. NO USER-SERVICEABLE PARTS INSIDE. REFER SERVICING TO QUALIFIED PERSONNEL.		



This symbol is intended to alert you to the presence of uninsulated dangerous voltage within the product's enclosure that might be of sufficient magnitude to constitute a risk of electric shock. Do not open the product's case.



This symbol is intended to inform you that important operating and maintenance instructions are included in the literature accompanying this product.

## READ THIS BEFORE INSTALLATION

Each device that you connect to the phone line draws power from the phone line. We refer to this power draw as the device's *ringer equivalence number*, or REN. The REN is shown on the bottom of the base.

If you are using more than one phone or other device on the line, add up all the RENs. If the total is more than five, your phones might not ring. In rural areas, a total REN of three might impair ringer operation. If ringer operation is impaired, remove a device from the line.

## FCC STATEMENT

This telephone complies with Part 68 of *FCC Rules*. You must, upon request, provide the FCC Registration Number and the REN to your phone company. These numbers are shown on the bottom of the base.

**Note:** You must not connect your phone to any of the following:

- coin-operated systems
- party-line systems
- most electronic key phone systems



# CONTENTS

<b>Preparation .....</b>	<b>5</b>
Installing Batteries .....	5
Testing/Replacing the Batteries .....	5
Selecting a Location .....	6
Placing the Phone on a Desk Top .....	6
Mounting the Phone on a Wall .....	6
Connecting the Handset .....	7
Connecting an Optional AC Adapter .....	8
Setting the Dialing Mode .....	9
Setting the Ringer Switch .....	9
<b>Operation .....</b>	<b>10</b>
Using the Speakerphone .....	10
Switching Between the Handset and Speakerphone .....	10
Using Privacy .....	10
Using Redial .....	10
Using Pause .....	11
Using Flash .....	11
Using Tone Services on a Pulse Line .....	11
Memory Dialing .....	12
Storing a Number in Memory .....	12
Dialing a Memory Number .....	13
Chain-Dialing Memory Numbers .....	13
Testing Stored Emergency Numbers .....	13
<b>Troubleshooting .....</b>	<b>14</b>
<b>Care and Maintenance .....</b>	<b>15</b>
The FCC Wants You to Know .....	15
Lightning .....	16

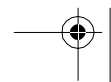
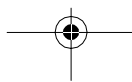
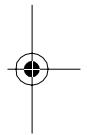

## PREPARATION

### INSTALLING BATTERIES

Your telephone uses two AAA batteries (not supplied) for power to retain the numbers you store in memory. For the best performance and longest life, we recommend alkaline batteries, such as Cat. No. 23-555.

#### Cautions:

- Always use fresh batteries of the required size and recommended type.
- Do not mix old and new batteries, different types of batteries (standard, alkaline, or rechargeable), or rechargeable batteries of different capacities.

1. Use a Phillips screwdriver to loosen the screw in the battery compartment cover on the bottom of the telephone, then lift open the cover.

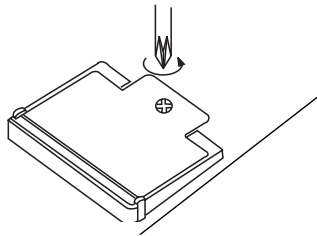

2. Put the batteries into the compartment as indicated by the polarity symbols (+ and -) marked inside.

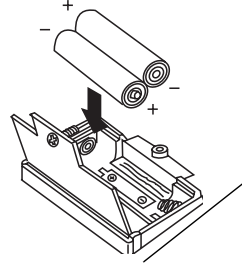

3. Close the cover and tighten the screw.
4. Be sure the **NORM/STORE BATT TEST** switch on the back of the phone is set to **NORM** (see "Testing/Replacing the Batteries").

### Testing/Replacing the Batteries

To test the batteries' strength at any time, temporarily slide **NORM/STORE BATT TEST** (on the back of the telephone) to **STORE BATT TEST**.

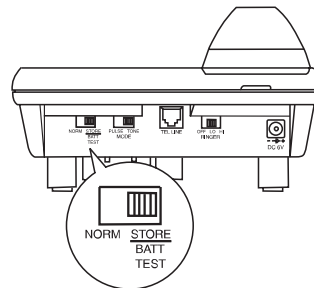

If the **BATT TEST** indicator does not light or is dim, replace the batteries.

To prevent the loss of stored numbers when the batteries are removed, replace the batteries within 5 minutes.

Set **NORM/STORE BATT TEST** back to **NORM**.

## SELECTING A LOCATION

You can place the phone on a desk top or table, or mount it on a telephone wall plate or directly on the wall. Select a location that is:

- Near a telephone line jack
- Out of the way of normal activities
- Near an AC outlet (*only* if you use an optional AC adapter; see "Connecting an Optional AC Adapter" on Page 8)

### Notes:

- Your telephone connects directly to a modular telephone line jack. If your phone line jack is not a modular jack, you can update the wiring yourself, using jacks and adapters available at your local RadioShack store. Or, you can let the phone company update the wiring for you.
- The USOC number of the jack to be installed is RJ11C (RJ11W if you want to mount it on a wall plate).

## Placing the Phone on a Desk Top

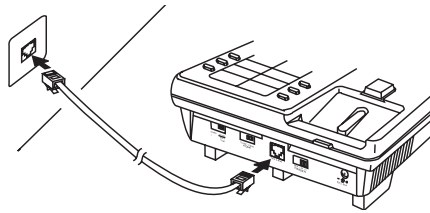

Plug one end of the supplied long modular cord into the **TEL LINE** jack on the back of the phone. Then plug the other end into a modular phone line jack.

## Mounting the Phone on a Wall

You can mount your telephone on a wall plate, or you can mount it directly on the wall using two screws (not supplied) with heads that fit into the keyhole slots on the bottom of the telephone.

**Note:** If you are mounting the phone directly on the wall, drill two holes  $3^{15}/16$  inches (100 mm) apart. Thread the two screws into the wall, letting the heads extend about  $1/8$  inch (3 mm).

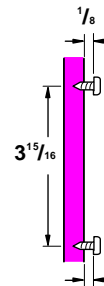

1. Press in on the side of the bracket nearest the **DESK** label and lift the bracket. Rotate the bracket 180° and insert it into the **WALL** slots, then push it upward to secure it.

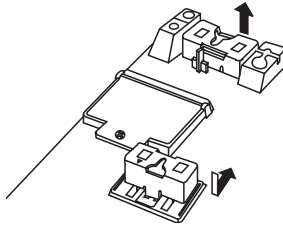

2. Plug one end of the supplied short modular cord into the **TEL LINE** jack on the back of the phone and plug the other end into a modular phone line jack. Then align the base's key-hole slots with the wall plate studs (or screws) and slide the base downward to secure it.

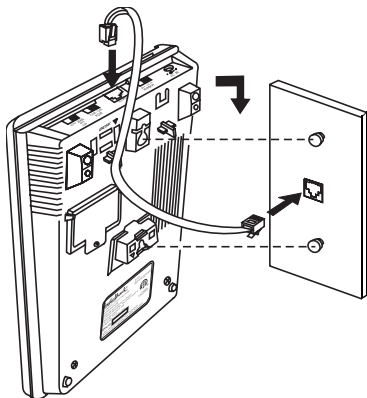

3. Lift out the handset guide, rotate it 180°, then snap it back into place so it holds the handset.

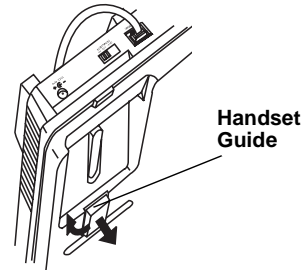

**Note:** The handset holder above the handset cradle lets you place the handset on the holder without disconnecting the call.

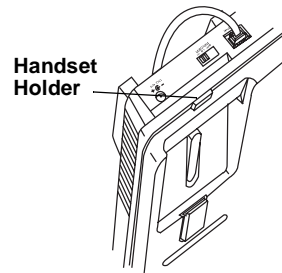

## CONNECTING THE HANDSET

Plug one end of the coiled cord into the modular jack on the handset. Then connect the other end to the jack on the side of the telephone base.

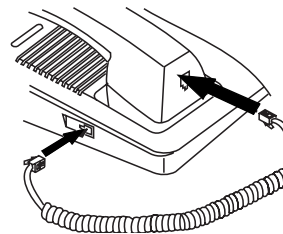

You might prefer a longer cord for the handset. Your local RadioShack store has a wide selection of telephone accessories, including longer coiled handset cords.

## CONNECTING AN OPTIONAL AC ADAPTER

Your telephone operates from telephone line power. In some areas, however, the telephone line might not provide enough power to operate all of your telephone's features. If the speakerphone's volume is too low, even with the volume control set to its highest setting, or if the speakerphone does not work, connect an AC adapter (RadioShack Cat. No. 273-1454).

### Cautions:

- The recommended adapter supplies 6 volts DC, delivers at least 150 milliamps, and has a barrel plug which properly fits the phone's **DC 6V** jack. Using an adapter that does not meet these specifications might damage the phone or the adapter.
- To prevent damage to the adapter and the telephone, always plug the adapter into the telephone before you plug it into the AC outlet. Always unplug the AC adapter from the AC outlet first, then unplug the barrel plug from the phone.

1. Plug the adapter's barrel plug into the **DC 6V** jack on the back of the telephone.

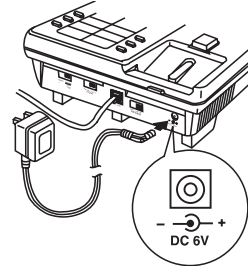

2. Route the adapter cable through the strain relief slot on the bottom of the telephone.

### Strain Relief Slot

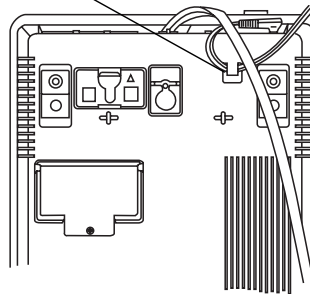

3. Plug the other end of the adapter into a standard AC outlet.

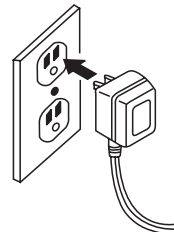



## SETTING THE DIALING MODE

Set **MODE** on the back of the base for the type of service you have (tone or pulse). If you are not sure which type you have, do this test.

1. Set **MODE** to **TONE**.

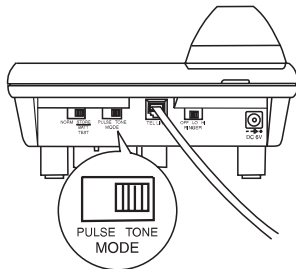

2. Lift the handset and listen for a dial tone.
3. Press any number other than **0**.

**Note:** If your phone system requires that you dial an access code (**9**, for example) before you dial an outside number, do not press the access code either.

4. If the dial tone stops, you have touch-tone service. Leave **MODE** set to **TONE**.

If the dial tone continues, you have pulse service. Set **MODE** to **PULSE**.

## SETTING THE RINGER SWITCH

Set **RINGER** on the back of the telephone to select the desired ringer volume:

**HI** — Normal ringer volume.

**LO** — Reduced ringer volume.

**OFF** — The telephone does not ring

**Note:** With the phone's ringer off, you can still make calls using the ET-148. You can also receive calls if you hear another telephone on the same line ringing.

## OPERATION

Make and receive calls with this phone as you would with any other phone. This section describes some of the phone's special features.

### USING THE SPEAKERPHONE

To make or receive a call on the speakerphone, leave the handset in the cradle and press **SPEAKER**.

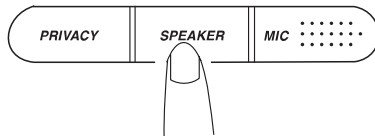

Slide **VOLUME** on the right side of the phone's base to adjust the speakerphone's volume.

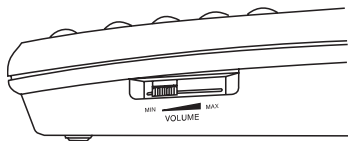

To disconnect a call, press **SPEAKER**.

### Switching Between the Handset and Speakerphone

To switch to the speakerphone while you are using the handset, press **SPEAKER** and return the handset to the cradle.

To switch to the handset while you are using the speakerphone, lift the handset then press **SPEAKER**.

If you decide to change from the speakerphone to the handset during redialing or memory dialing, let the phone finish dialing first. Then lift the handset and press **SPEAKER**.

### USING PRIVACY

To talk to someone else in the room without the person on the other end of the phone line hearing your conversation, press **PRIVACY** during the call. The **PRIVACY** indicator lights.

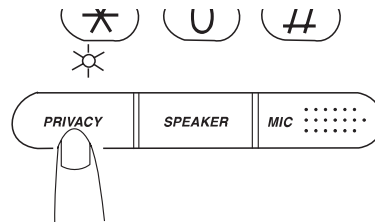

Press **PRIVACY** again to resume your phone conversation. The indicator light turns off.

### USING REDIAL

**PAUSE/REDIAL** lets you quickly dial the last number dialed. Lift the handset (or press **SPEAKER**), then simply press **PAUSE/REDIAL**.

When you press **PAUSE/REDIAL**, the telephone redials in the mode (tone or pulse) in which you originally dialed the number.

### Notes:

- The redial memory holds up to 32 digits in the pulse mode and 31 digits in the tone mode. This means you can redial long-distance as well as local numbers.
- The redial memory also holds pause entries (see "Using Pause").
- The redial memory does not store a flash entry or any digits you press after **FLASH** (see "Using Flash").

## USING PAUSE

In some telephone systems, you must dial an access code (9, for example) and wait for a second dial tone before you can dial an outside number. You can store the access code with the phone number. However, you should also store a pause after the access code to allow the outside line time to connect.

To enter a 2-second pause, press **PAUSE/REDIAL** at the desired location. For a longer pause, press **PAUSE/REDIAL** additional times.

## USING FLASH

**FLASH** performs the electronic equivalent of a switchhook operation for special services, such as Call Waiting or transferring a call to another line in an office network.

For example, if you have call waiting, press **FLASH** to answer an incoming call without disconnecting the current call.

Press **FLASH** again to return to the first call.

**Note:** If you do not have any special phone services, pressing **FLASH** might disconnect the current call.

## USING TONE SERVICES ON A PULSE LINE

Some computer services, such as alternate long-distance and bank-by-phone, require tone signals. If you have pulse service, you can still use these special tone services by following these steps.

1. Be sure **MODE** is set to **PULSE**.
2. Dial the service's main number.
3. When the special service answers, set **MODE** to **TONE**. Any additional numbers you dial are sent as tone signals.
4. After you complete the call, hang up the handset (or press **SPEAKER**) and return **MODE** to **PULSE**.

**Note:** You cannot change from the tone mode to the pulse mode during a call. To make this change, you must hang up the handset (or press **SPEAKER**) then set **MODE** to **PULSE**.

## MEMORY DIALING

You can store up to 20 numbers in memory (15 digits each in the tone mode, 16 in the pulse mode), then dial a stored number by pressing a memory button.

**Note:** Entering a pause counts as one digit in memory.

### Storing a Number in Memory

**Note:** Leave the handset in its cradle when storing a number.

#### Important:

- If you attempt to store a number while the BATT TEST indicator is not lit, all stored numbers are deleted.
- If BATT TEST does not light or is dim, replace the batteries. See "Testing/Replacing the Batteries" on Page 5.
- Do not attempt to store a telephone number with no batteries or weak batteries.

1. Be sure **MODE** is set for the type of service you have.

2. Set **NORM/STORE BATT TEST** to **STORE BATT TEST**. The BATT TEST indicator lights.

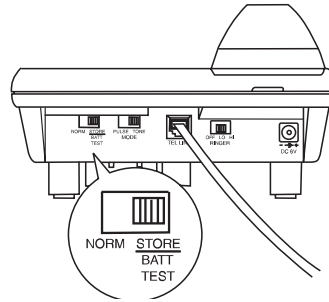

3. Enter the number and any pause entries.
4. Press the memory button for where you want to store the number and write the person's or company's name on the supplied Memory Index Card. (Use a pencil in case you want to change the number later.)

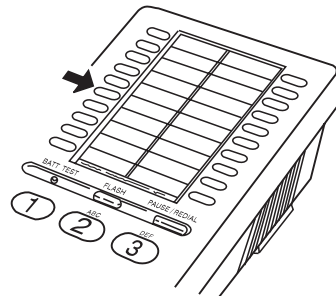

Repeat Steps 3 and 4 for each number you want to store.

5. When you finish storing numbers, return **NORM/STORE BATT TEST** to **NORM**.

### Notes:

- If the telephone rings while you are storing numbers, you can answer the call by lifting the handset or pressing **SPEAKER**. If you answer a call before pressing the memory button for the number you were storing, you must start again from Step 3 after the phone call.
- If you make a mistake while storing a number, return **NORM/STORE BATT TEST** to **NORM** then reset it to **STORE BATT TEST**. Then re-enter the number. Or, lift the handset then return it to the telephone base and re-enter the number.

You cannot delete a stored number, but you can store a new number in its place.

### Dialing a Memory Number

To dial a number stored in memory, lift the handset or press **SPEAKER**. When you hear a dial tone, press the memory button for the number you want to dial.

### Chain-Dialing Memory Numbers

For quick recall of numbers for special services (such as alternate long distance or bank by phone), store each group of numbers in its own memory location.

Dial the service's main number first. Then, at the appropriate place in the call, press the memory button where the additional information is stored.

**Note:** We recommend you do not store private or secure numbers, such as PINs.

### Testing Stored Emergency Numbers

If you store an emergency service's number (police department, fire department, ambulance) and you choose to test the stored number, make the test call during the late evening or early morning hours to avoid peak demand periods. Also, remain on the line to explain the reason for your call.

## TROUBLESHOOTING

We do not expect you to have any problems with your phone, but if you do, the following suggestions might help.

Problem	Suggestion
The phone does not work or works poorly.	Be sure <b>MODE</b> is set properly.
	Ensure the phone line is properly connected.
	If you are using an optional AC adapter, ensure it is properly connected. See "Connecting an Optional AC Adapter" on Page 8.
Memory does not hold programmed numbers.	Replace the batteries (see "Testing/Replacing the Batteries" on Page 5).
The party on the phone cannot hear you, but you can hear them.	Check the <b>PRIVACY</b> indicator. If the light is on, press <b>PRIVACY</b> so it is off.
The telephone's volume level drops or it begins to make strange sounds.	Check to see if other phones on the same line have been picked up. This phone might not operate when other phones are active on the same line (especially in areas with low telephone voltage). Hang up the other phones.
	If you are using an optional AC adapter, ensure it is properly connected. See "Connecting an Optional AC Adapter" on Page 8.

If you still have problems, disconnect the phone. If other phones on the same line work properly, the fault is in this phone or its installation. If you cannot find the problem, take your phone to your local RadioShack store for assistance.



## CARE AND MAINTENANCE

---



Your RadioShack ET-148 20-Number Memory Speakerphone with Privacy is an example of superior design and craftsmanship. The following suggestions will help you care for your phone so you can enjoy it for years.

- Keep the phone dry. If it gets wet, wipe it dry immediately. Liquids might contain minerals that corrode electronic circuits.
- Use and store the phone only in normal temperature environments. High temperature extremes can shorten the life of electronic devices, and distort or melt plastic parts.
- Handle the phone gently and carefully. Dropping it can damage circuit boards and cases and can cause the phone to work improperly.
- Keep the phone away from dust and dirt, which can cause premature wear of parts.
- Wipe the phone with a damp cloth occasionally to keep it looking new. Do not use harsh chemicals, cleaning solvents, or strong detergents to clean your phone.

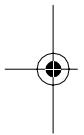

Modifying or tampering with the telephone's internal components can cause a malfunction and might invalidate your telephone's warranty and void your FCC authorization to operate it. If your telephone is not performing as it should, take it to your local RadioShack store for assistance. If the trouble is harming the phone lines, the telephone company might ask you to disconnect your phone until you have resolved the problem.

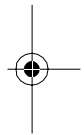

## THE FCC WANTS YOU TO KNOW

In the unlikely event that your phone causes problems on the phone line, the phone company can temporarily discontinue your service. If this happens, the phone company attempts to notify you in advance. If advance notice is not practical, the phone company notifies you as soon as possible and advises you of your right to file a complaint with the FCC.

Also, the phone company can make changes to its lines, equipment, operations, or procedures that could affect the operation of this telephone. The telephone company notifies you of these changes in advance, so you can take the necessary steps to prevent interruption of your telephone service.

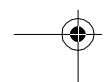
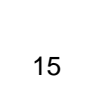
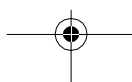

## LIGHTNING

Your telephone has built-in protection circuits to reduce the risk of damage from surges in telephone line and power line current. These protection circuits meet or exceed the FCC requirements. However, lightning striking the telephone or power lines can damage your telephone.

Lightning damage is not common. Nevertheless, if you live in an area that has frequent electrical storms, we suggest that you unplug your telephone during storms to reduce the possibility of damage.

### Limited One-Year Warranty

This product is warranted by RadioShack against manufacturing defects in material and workmanship under normal use for one (1) year from the date of purchase from RadioShack company-owned stores and authorized RadioShack franchisees and dealers. EXCEPT AS PROVIDED HEREIN, RadioShack MAKES NO EXPRESS WARRANTIES AND ANY IMPLIED WARRANTIES, INCLUDING THOSE OF MERCHANTABILITY AND FITNESS FOR A PARTICULAR PURPOSE, ARE LIMITED IN DURATION TO THE DURATION OF THE WRITTEN LIMITED WARRANTIES CONTAINED HEREIN. EXCEPT AS PROVIDED HEREIN, RadioShack SHALL HAVE NO LIABILITY OR RESPONSIBILITY TO CUSTOMER OR ANY OTHER PERSON OR ENTITY WITH RESPECT TO ANY LIABILITY, LOSS OR DAMAGE CAUSED DIRECTLY OR INDIRECTLY BY USE OR PERFORMANCE OF THE PRODUCT OR ARISING OUT OF ANY BREACH OF THIS WARRANTY, INCLUDING, BUT NOT LIMITED TO, ANY DAMAGES RESULTING FROM INCONVENIENCE, LOSS OF TIME, DATA, PROPERTY, REVENUE, OR PROFIT OR ANY INDIRECT, SPECIAL, INCIDENTAL, OR CONSEQUENTIAL DAMAGES, EVEN IF RadioShack HAS BEEN ADVISED OF THE POSSIBILITY OF SUCH DAMAGES.

Some states do not allow the limitations on how long an implied warranty lasts or the exclusion of incidental or consequential damages, so the above limitations or exclusions may not apply to you.

In the event of a product defect during the warranty period, take the product and the RadioShack sales receipt as proof of purchase date to any RadioShack store. RadioShack will, at its option, unless otherwise provided by law: (a) correct the defect by product repair without charge for parts and labor; (b) replace the product with one of the same or similar design; or (c) refund the purchase price. All replaced parts and products, and products on which a refund is made, become the property of RadioShack. New or reconditioned parts and products may be used in the performance of warranty service. Repaired or replaced parts and products are warranted for the remainder of the original warranty period. You will be charged for repair or replacement of the product made after the expiration of the warranty period.

This warranty does not cover: (a) damage or failure caused by or attributable to acts of God, abuse, accident, misuse, improper or abnormal usage, failure to follow instructions, improper installation or maintenance, alteration, lightning or other incidence of excess voltage or current; (b) any repairs other than those provided by a RadioShack Authorized Service Facility; (c) consumables such as fuses or batteries; (d) cosmetic damage; (e) transportation, shipping or insurance costs; or (f) costs of product removal, installation, set-up service adjustment or reinstallation.

This warranty gives you specific legal rights, and you may also have other rights which vary from state to state.

RadioShack Customer Relations, Dept. W, 100 Throckmorton St., Suite 600, Fort Worth, TX 76102

*We Service What We Sell*

3/97

**RadioShack**  
**A Division of Tandy Corporation**  
**Fort Worth, Texas 76102**