

VSSI-PRO

Version 13



VIDEO SERIAL SYNCHRONOUS ATM INTERFACE

Operation Manual

APRIL 2006



VSSI-PRO

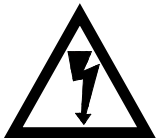

WARNING!

RISK OF ELECTRICAL SHOCK!



DO NOT OPEN!

TO PREVENT FIRE OR ELECTRIC SHOCK, DO NOT REMOVE COVER. NO USER SERVICEABLE PARTS INSIDE. REFER SERVICING TO QUALIFIED PERSONNEL.

WARNING!

THIS EQUIPMENT GENERATES, USES, AND CAN RADIATE RADIO FREQUENCY AND IF NOT INSTALLED AND USED IN ACCORDANCE WITH THE INSTRUCTION MANUAL MAY CAUSE INTERFERENCE TO RADIO COMMUNICATIONS. IT HAS BEEN TESTED AND FOUND TO COMPLY WITH THE LIMITS FOR A CLASS A COMPUTING DEVICE PURSUANT TO SUBPART J OF PART 15 FCC RULES, WHICH ARE DESIGNED TO PROVIDE REASONABLE PROTECTION AGAINST SUCH INTERFERENCE WHEN OPERATED IN A COMMERCIAL ENVIRONMENT. OPERATION OF THIS EQUIPMENT IN A RESIDENTIAL AREA IS LIKELY TO CAUSE INTERFERENCE IN WHICH CASE THE USER AT HIS/HER OWN EXPENSE WILL BE REQUIRED TO TAKE WHATEVER MEASURES MAY BE REQUIRED TO CORRECT THE INTERFERENCE.

AVE Multiview UK

Granyte House, Delamare Road
Cheshunt, Hertfordshire EN8 9SP
Tel: 440-870-770-9323
Fax: 440-870-770-9363
Email: enquiries@ave-uk.com
<http://www.multiview.net>

AVE Multiview USA

2000 West Governors Circle
Suite E, Houston, Texas 77092
Tel: 1-281-443-2300
Fax: 1-281-443-8915
Email: sales@aveusa.com
<http://www.americanvideoequipment.com>

AVE (Thailand) Co., Ltd.

217/4 Crystal Garden, Soi 4 (Nanatai)
Sukhumvit Rd., Klongtoey, Klongtoey
Bangkok 10110 Thailand
Tel: 662-656-8231
Fax: 662-656-9554
Email: ave@avethailand.com
<http://www.ave.co.th> (Thai)
<http://www.avethailand.com> (English)

Copyright © AVE Thailand Co., Ltd. 2000-2006

- Features.....6
- Specifications.....7
- Connecting the VSSI-Pro.....9
 - Introduction.....9
 - Connecting the VSSI-Pro.....9
 - ATM to VSSI-Pro Installation.....10
 - VSSI-Pro Video Connection.....10
 - VSSI-Pro Connections.....10
 - External Alarm Output.....12
 - Serial Input.....12
- Programming the VSSI-Pro.....13
 - A Few Words About Programming.....13
 - User Front Panel Controls.....13
 - Programming - Getting Started.....14
 - Programming Menus.....15
 - Main-Menu for Programming.....15
 - ATM Select.....15
 - TCPIP 232 Adapter.....16
 - Custom.....19
 - Screen Setup.....19
 - Text Grayscale.....19
 - Background Grayscale.....19
 - Horizontal Position.....19
 - Vertical Position.....19
 - Clock.....20
 - More On Time/Date Locking.....20
 - On-Screen Titler.....20
 - Titler.....20
 - Set Titler.....20
 - Text Display.....22
 - Screen Blank.....22
 - Display Lines.....22
 - Line Compress.....22
 - Left Justified.....22
 - Scroll Delay.....22
 - Display.....24
- Communication.....24
 - Port 1.....24
 - Port A : B.....26
 - ASYNC.....26
 - BISYNC.....27
 - SDLC.....27
- Exception Report.....28
 - On-Screen Flags.....28
 - Hard Alarm Output.....28
 - Printer or DVR Output.....29
 - Exception History.....29
 - Total Exceptions.....29
 - View Exceptions.....29
 - DVR Selection.....30
 - Time Search.....32
 - Set Exception.....33
 - Exception String.....34
 - Negative Exceptions.....35
 - Operator.....35
 - Range.....35
- Alarm Outputs.....36
 - Alarm No.....37
 - Alarm Trigger.....37
 - Normal State.....38

CONTENTS

| | |
|-----------------------------|----|
| Alarm Outputs (Continued) | |
| Flag Type..... | 38 |
| Flag Duration..... | 38 |
| Triggered Text..... | 39 |
| Test/Demo Mode..... | 40 |
| Port 1 Test..... | 40 |
| Port A Test..... | 42 |
| Port B Test..... | 43 |
| ATM Demo..... | 44 |
| Version Identification..... | 45 |
| Download/Upload Setup..... | 45 |
| Help..... | 48 |

APPENDICES

| | |
|---|----|
| APPENDIX A : Data Dump Connections..... | 49 |
| APPENDIX B : Problem Solving Guide..... | 50 |
| APPENDIX C : Master Reset the VSSI-Pro..... | 51 |
| APPENDIX D : Frequently Asked Questions..... | 52 |
| APPENDIX E : RS-485 Networker..... | 53 |
| APPENDIX F : PC Software with ATM Select..... | 54 |
| APPENDIX G : Hard Alarm Output..... | 55 |
| APPENDIX H : Triport and Adapter Cable..... | 56 |
| APPENDIX I : Pin Assignment for the Time Search Function..... | 57 |
| APPENDIX J : Limited Warranty..... | 58 |
| APPENDIX K : Notes..... | 60 |

TABLES

| | |
|--|----|
| Table 1 : Pin-Out of the DB-9 Connector on the VSSI-Pro..... | 11 |
| Table 2 : Pin-Out DB-9 Male Connector DB-25 Triport..... | 11 |
| Table 3 : Pin-Out ATM Camera Interface DB-9 Male Connector DB-25 Male..... | 12 |
| Table 4 : Triport Pin-Out..... | 48 |
| Table 1A : Data Dump Connections..... | 49 |
| Table 1H : The VSSI-Pro ATM 2 Channel..... | 56 |
| Table 2H : ATM Camera Port Connection..... | 56 |
| Table 3H : TCP/IP Cable..... | 56 |
| Table 4H : Data Output Option..... | 56 |
| Table 5H : RTS Triggered Text..... | 56 |

FIGURES

| | |
|---|----|
| Figure 1 : Typical VSSI-Pro Connection..... | 9 |
| Figure 2 : The VSSI-Pro Connections..... | 10 |
| Figure 3 : The VSSI-Pro Four Button Access all the Programming..... | 13 |
| Figure 4 : Four Front Panel Push Buttons of VSSI-Pro (Down)..... | 13 |
| Figure 5 : Four Front Panel Push Buttons of VSSI-Pro (Up)..... | 14 |
| Figure 6 : Four Front Panel Push Buttons of VSSI-Pro (Set)..... | 14 |
| Figure 7 : Main-Menu Programming VSSI-Pro..... | 15 |
| Figure 8 : ATM Select Sub-Menu..... | 15 |
| Figure 9 : SDLC Sub-Menu..... | 16 |
| Figure 10 : BISYNC Sub-Menu..... | 16 |
| Figure 11 : ASYNC Sub-Menu..... | 16 |
| Figure 12 : Camera Port Sub-Menu..... | 16 |
| Figure 13 : Journal Printer Sub-Menu..... | 16 |
| Figure 14 : NCR Thermal Printers Sub-Menu..... | 16 |
| Figure 15 : Front of TCPIP 232 Adapter..... | 16 |
| Figure 16 : TCPIP 232 Adapter Connections..... | 17 |

FIGURES (Continued)

| | |
|---|----|
| Figure 17 : The VSSI-Pro Connections to TCPIP 232 Adapter..... | 17 |
| Figure 18 : TCPIP Interface Sub-Menu..... | 18 |
| Figure 19 : TCPIP Format I Sub-Menu..... | 18 |
| Figure 20 : TCPIP Interface Sub-Menu..... | 18 |
| Figure 21 : TCPIP Debugging Sub-Menu..... | 18 |
| Figure 22 : Custom Sub-Menu..... | 18 |
| Figure 23 : Screen Setup Sub-Menu..... | 19 |
| Figure 24 : Clock Sub-Menu..... | 20 |
| Figure 25 : On-Screen Titler Sub-Menu..... | 21 |
| Figure 26 : Text Display Sub-Menu..... | 22 |
| Figure 27 : Communication Sub-Menu..... | 24 |
| Figure 28 : Port 1 Sub-Menu..... | 24 |
| Figure 29 : Port A : B Sub-Menu..... | 26 |
| Figure 30 : ASYNC Sub-Menu..... | 26 |
| Figure 31 : BISYNC Sub-Menu..... | 27 |
| Figure 32 : SDLC Sub-Menu..... | 27 |
| Figure 33 : Exception Report Sub-Menu..... | 29 |
| Figure 34 : Exception History Sub-Menu..... | 29 |
| Figure 35 : View Exceptions Display..... | 30 |
| Figure 36 : DVR Selection Sub-Menu..... | 30 |
| Figure 37 : DVR-3011.3021 Sub-Menu..... | 30 |
| Figure 38 : VSSI-Pro with DVR Connections..... | 31 |
| Figure 39 : Time Search Sub-Menu..... | 32 |
| Figure 40 : Set Exception Sub-Menu..... | 33 |
| Figure 41 : Alarm Outputs Sub-Menu..... | 36 |
| Figure 42 : Triggered Text Sub-Menu..... | 39 |
| Figure 43 : Set Triggered Text Sub-Menu..... | 39 |
| Figure 44 : Test/Demo Mode Sub-Menu..... | 40 |
| Figure 45 : Port 1 Test Sub-Menu..... | 40 |
| Figure 46 : Receive [RX] Test Sub-Menu..... | 40 |
| Figure 47 : Transmit [TX] Test Sub-Menu..... | 41 |
| Figure 48 : RX/TX Test Sub-Menu..... | 41 |
| Figure 49 : Baud Rate Scan Sub-Menu..... | 42 |
| Figure 50 : Port A Test Sub-Menu..... | 42 |
| Figure 51 : Receive [RX] Test Display..... | 42 |
| Figure 52 : Transmit [TX] Test Sub-Menu..... | 43 |
| Figure 53 : Data Capture Sub-Menu..... | 43 |
| Figure 54 : Data Capture Port 1 Display..... | 43 |
| Figure 55 : Data Capture to Memory Sub-Menu..... | 44 |
| Figure 56 : Dump TCP/IP Sub-Menu..... | 44 |
| Figure 57 : Dump TCP/IP Display..... | 44 |
| Figure 58 : ATM Demo Display..... | 45 |
| Figure 59 : Version / Revision Identification Display..... | 45 |
| Figure 60 : Pin-Out for Download/Upload Data Cable..... | 45 |
| Figure 61 : Download/Upload Setup Using VSSI-Pro to VSSI-Pro..... | 46 |
| Figure 62 : Download/Upload Setup Sub-Menu..... | 47 |
| Figure 63 : Download Setup Sub-Menu & Display..... | 47 |
| Figure 64 : Upload Setup Sub-Menu & Display..... | 47 |
| Figure 65 : Help Sub-Menu..... | 48 |
| Figure 1A : Data Dump Connections..... | 49 |
| Figure 1E : Connection Diagram for RS-485 Network..... | 53 |
| Figure 1F : Window Tile Horizontal..... | 54 |
| Figure 1G : Hard Alarm Output..... | 55 |
| Figure 1H : The VSSI-Pro ATM 2 Channel..... | 56 |
| Figure 1I : Pin Assignment for Time Search Function..... | 57 |
| Figure 2I : TCPIP 232 Adapter Connection Pin-Out..... | 57 |
| Figure 3I : SDLC / BISYNC / ASYNC / ATM Connection Pin-Out..... | 57 |
| Figure 4I : Camera Controller Connection Pin-Out..... | 57 |

FEATURES

FEATURES

The VSSI-Pro ATM Interface allows one unit to connect to all ATMs and Networks by all possible methods to support any banking requirement.

- Easy Menu-driven Setup and Programming
- Number of Display Lines Programmable
- Supports DVR Command Set for Auto Search Capability
- Supports the AVE Networker & Hydra for connection to many 3rd party DVR manufacturers
- Programmable on-screen time/date display. The on-board real-time clock can run in stand-alone mode or locked to ATM time/date mode
- Auto / Manual Network Configuring
 - SDLC (SNA / X.25)
 - BISYNC (IBM3670/3675)
 - ASYNC (RS-232C)
 - CAMERA PORT (RS-232C)
 - JOURNAL / RECEIPT PRINTER (RS-232C / Special)
 - TCP/IP INTERFACE (Ethernet 10/100Mbs with optional TCPIP 232 Adapter)
 - CUSTOM (Special)
- Automatic Poll/Select Address Configuring
- Negative Exceptions (Removes Unwanted Data from View)
- Alarm Input for CARD Reader—CARD IN (RTS Trigger Text option)
- Serial Data Output of all data or Exceptions
- Allows Transaction Data to be sent to:
 - DVRs
 - Phone Line Transmission System
 - Computers / Printers
- Programmable Hard Wire Alarm Output
- Powerful Data Filtering Algorithms
- 24 Field Programmable Exceptions with Numeric Range
- Operators & Exception String to provide Greater than, Less than, Equal to Exceptions, in between or out of the numeric range.
- On-screen Flagging of Exceptions with Asterisk or Reverse Text
- On-screen Titler up to 20 Characters
- Character Gray Scale Programmable 8 levels
- Border Selection and Gray Scale Programmable 8 levels
- Built-in Test Mode
- Built-in ATM Demo
- Upload/Download Programming to a PC or another VSSI-Pro
- Programmable Time-Stamp on Exception Output. If turned on, each output line will be preceded by the current time/date.
- Universal time/date format. The time display can be set to either 12 or 24 hour format. The date display can be set to *MM/DD/YY*, *DD/MM/YY* or *YY/MM/DD*.
- 100 lines Exception History Buffer. More than 100 lines of Exceptions and Time Stamp are buffered in the battery-backed SRAM
- The buffered exceptions can be reviewed and printed at anytime.
- 16 Triggered Text associated with 16 alarms. Each triggered text can be 40 characters long and can contain any ASCII values. When an alarm is triggered by any source, the associated Triggered Text is displayed and output if enabled, respectively.
- Larger data buffers for input/output to accomodate newer, faster ATM networks.
- Programmable Delay Screen Blanking
- Your Choice of 1 to 11 lines displayed on-screen



SPECIFICATIONS

| | |
|-------------------------------|--|
| Video In (BNC) | 1V P-P Terminated 75 ohms +/- 20% |
| Video Out (BNC) | 1V P-P Terminated or Unterminated |
| Video S / N | better than 50dB |
| Video B / W | better than 7MHz |
| Power (DC Coax 2.1mmx5.5mm) | 9-12VDC 130mA nominal, 150mA maximum with Alarms |
| Battery Backup NiMH | 1 year with 24 hour charge |
| Serial Ports (DB-9) Female | |
| Serial Port 1 | |
| | RS-232C |
| Baud Rate | Auto, 135, 150, 300, 600, 1200, 2400, 4800, 9600, 19.2K, 28.8K, 38.4K |
| Word Length | 7 or 8 |
| Parity | ODD, EVEN, NONE |
| Stop Bits | 1 |
| Serial Port A or B | |
| | RS-232C – ASCII |
| Baud Rate | Auto, 135, 150, 300, 600, 1200, 2400, 4800, 9600, 19.2K, 28.8K, 38.4K |
| Word Length | 7 or 8 |
| Parity | ODD, EVEN, NONE |
| Stop Bits | 1 |
| | SDLC: NRZ, NRZI, NRZID |
| | BISYNC: NRZ, NRZI |
| | FORMAT: ASCII or EBCDIC |
| Baud Rate | AUTO, 135, 150, 300, 600, 1200, 2400, 4800, 9600, 19.2K, 28.8K, 38.4K, 57.6K, 115.2K |
| Data Buffer | 32K bytes |
| Alarm Output | Open Collector 12VDC @ 20mA |
| RTS Alarm Input | Hi-Z Pulled up with 3.3K |
| Real Time Clock | 12 or 24 Hr. |
| Host Time Locking | |
| Display Characters | 40 |
| Number of Lines | 1-11 |
| Character Gray Scale | 8 levels of Gray |
| Matte Character Border | 8 levels of Gray |
| Screen Update Delay .5s | ON, OFF |
| Auto Scrolling from last line | |
| Line Processing | Compress, Truncate, Left Justify |

SPECIFICATIONS

Watchdog Timer Hardware and Software

| | |
|---------------------------------|---|
| Temperature Rating | 0 – 50 degrees Celsius 32 – 122 degrees Fahrenheit |
| Humidity | Non-Condensing 85% RH |
| VSSI-Pro | 0.70 Kg or 1.55 lbs |
| Beige Metal Enclosure | 130L x 127W x 38H (mm) 5.12L x 5W x 1.5H (in) |
| Maximum Size with Connectors | 145L x 127W x 43H (mm) 5.7L x 5W x 1.7H (in) |
| Packed in White Box with Manual | 1.20 kg or 2.65 lbs 340L x 190W x 85H (mm) 13.4L x 86.2W x 3.35H (in) |

INTRODUCTION

The VSSI-Pro is designed for controlling loss and fraud at the ATM terminal. When connected between an ATM and a recording device such as a VCR or DVR it monitors the data stream, overlaying the ATM's transaction data onto the video picture to get a complete picture of every transaction. The data can also be discretely sent to a remotely located serial printer. The video input can be virtually any baseband or composite video source. The VSSI-Pro will accept NTSC, RS-170, RS-330, CCIR, PAL, or SECAM video formats.

With its powerful Exceptions feature, the VSSI-Pro can provide on-screen alerts for whatever transactions you program as an exception, making these exceptions easy to review on the recorded video. The programmed exceptions can also be used to trigger an alarming devices such as VCR's, DVR's, Quads, Enunciators, LED's or other alarming devices, or a PC to record only the exception, or to the send data to another serial device such as a serial printer. The VSSI-Pro can also be programmed to save the exceptions in buffered memory so can then be viewed and printed at any time.

The VSSI-Pro handles all ATM communication formats worldwide with its unique auto-configuration program. It features Auto-Poll Select Address Setup and Auto-Network Configuring, 2 programmable Alarm Outputs, and Card Reader Contact Input.

CONNECTING THE VSSI-PRO

The most typical VSSI-Pro connection is between the ATM's modem and the ATM's SDLC, BISYNC, or ASSYNC network. This is done using the AVE Triport ATM 2CH cable. The triport has male and female DB-25 connectors back-to-back which connect to the ATM modem and the ATM network. From the side of the back-to-back DB-25 connectors extends a cable with a DB-9 male connector which plugs into the VSSI-Pro rear port labeled "RS-232".

The triport connection can be made while the ATM is on-line as long as you do so within 3 seconds and no one is doing a transaction. If you take longer than this the ATM may go off-line, but if this happens, wait approximately 5 minutes and the ATM will return on-line automatically.



Figure 1: Typical VSSI-Pro Connections

NOTE 

Prolonged periods of time with the ATM disconnected from the network will require a service technician to bring the ATM back on-line.

CONNECTING THE VSSI-PRO

ATM TO VSSI-PRO INSTALLATION

Locate the connector on the ATM's modem and loosen the 2 retaining screws, then quickly plug in the appropriate DB-25 connector of the triport into the modem. Next plug the modem cable into the other DB-25 connector of the triport, and plug the DB-9 connector into the VSSI-Pro.

NOTE

Make sure no one is operating the ATM when you disconnect the DB-25 connector.

IMPORTANT

The input video level must be 1V P-P. If this level is not maintained within +/- 20%, the VSSI-Pro will have difficulty locking the character display over the input video source. If the display is jumpy or tears this is a common symptom of input video level that is too high or too low.

VSSI-PRO VIDEO CONNECTION

The video input to the VSSI-Pro is a standard BNC connector terminated at 75 ohm.

After completing the interface installation, connect the video input source to the video input BNC on the rear of the VSSI-Pro. The BNC video output connects to the video system (DVR, VCR, Quad, switcher, Multiplexer, or monitor).

VSSI-PRO CONNECTIONS

The video output from the VSSI-Pro is 1V P-P into a 75 ohm load or unterminated load. Most monitors or televisions with direct video inputs are terminated with a 75 ohm load.

Included with the VSSI-Pro is a 9 VDC @ 300mA UL/CSA power supply which must be plugged into the power input on the VSSI-Pro's rear panel.



Figure 2: VSSI-Pro Connections

Cable and Connection: Pin-out of the DB-9 connector on the VSSI-Pro.

| PIN NUMBER | FUNCTION | DIRECTION |
|------------|------------------------------|---------------|
| 1 | ALARM OUT 1 | OPEN DRAIN |
| 2 | RXD/RXDB (CH 1 RECEIVE DATA) | TO VSSI-PRO |
| 3 | TXD (TRANSMIT DATA) | FROM VSSI-PRO |
| 4 | RXCA (CH 2 RX CLOCK) | TO VSSI-PRO |
| 5 | GND (GROUND) | |
| 6 | RXDA (CH 2 RECEIVE DATA) | TO VSSI-PRO |
| 7 | RXCB (CH 1 RX CLOCK) | TO VSSI-PRO |
| 8 | TXDA (TRANSMIT DATA) | FROM VSSI-PRO |
| 9 | CTS/RTS | TO VSSI-PRO |

Table 1: Pin-Out of the DB-9 Connector on the VSSI-Pro

This interface uses the Triport ATM 2CH cable to tap the communication between the ATM machine and modem. (See pin-out below.)

| DB-9 (MALE) VSSI-Pro | DB-25 TRIPORT | |
|----------------------|-----------------------|------------------------|
| 2 | 2 | |
| 4 | 17 | |
| 5 | 7 | |
| 6 | 3 | |
| 7 | 15 | |
| WITH DATA-OUT OPTION | DB-9 (MALE OR FEMALE) | DB-25 (MALE OR FEMALE) |
| 3 | 2 | 3 |
| 5 | 5 | 7 |

Table 2: Pin-Out of the DB-9 Male Connector DB-25 Triport

CONNECTING THE VSSI-PRO

To interface with a camera port, the following cable should be used. Cable between ATM camera interface and VSSI-Pro:

| | | |
|--------------------------------------|------------------------------|-------------------------------|
| CAMERA INTERFACE DB-25 (MALE) | DB-9 (MALE) | |
| 2 3 7 | 3 6 5 | |
| WITH DATA-OUT OPTION | DB-9 (MALE OR FEMALE) | DB-25 (MALE OR FEMALE) |
| 8 5 | 2 5 | 3 7 |

Table 3: Pin-Out of the ATM Camera Interface DB-9 Male Connector DB-25 Male

EXTERNAL ALARM OUTPUT

You will be able to tie your exceptions to one open collector hard alarm output. You have to physically add wires to the DB-9 connector which plugs into the rear of the VSSI-Pro. Pin 1 on the DB-9 is Alarm and Pin 5 is ground. Be sure to observe polarity and do not exceed the 12V, 20mA rating of these alarm outputs.

SERIAL INPUT

The VSSI-Pro accepts serial data via the DB-9 female connector located at the rear and also sends serial data using the same connector.

A FEW WORDS ABOUT PROGRAMMING

The VSSI-Pro is programmed by pressing and releasing specific combinations of the four front panel push-buttons. Via these four simple buttons, all of the powerful programming features of the VSSI-Pro are available to you. A video source and a monitor must be connected in order for you to see the programming menus. The following sections provide detailed programming instructions.



Figure 3: VSSI-Pro Four Push-Button Access to all the Programming

USER FRONT PANEL CONTROLS

Front panel push-button controls are provided to allow simple changing of the display’s vertical and horizontal position and the gray scale or border. This eliminates the need of the user to enter the main-menu, and eliminates the risk of inadvertently changing important programming settings.

Changing the Gray Scale

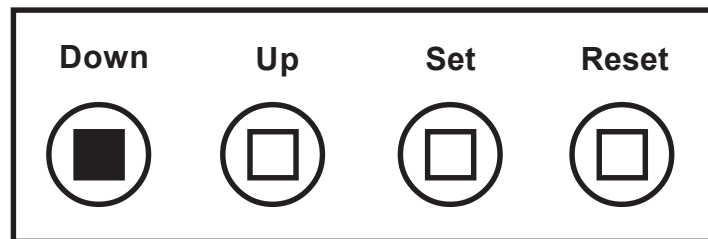

Figure 4: Four Front Panel Push-Buttons of VSSI-Pro (Down)

1. Press and hold the “Down” button.
2. Press and release the “Reset” button.
3. Release the “Down” button.
4. Press “Down” or “Up” to select the gray scale.
5. When the choice is made, press and release the “Set” button.

PROGRAMMING THE VSSI-PRO

Changing the Horizontal Position

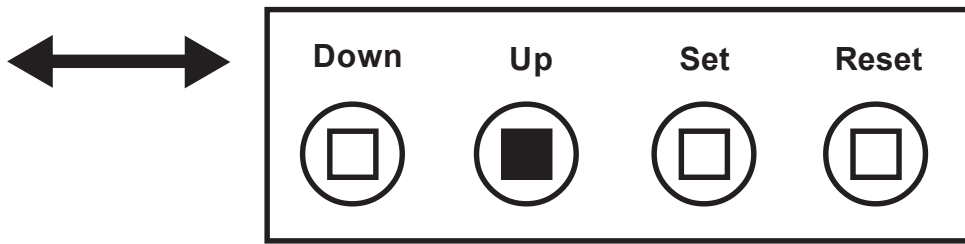

Figure 5: Four Front Panel Push-Buttons of VSSI-Pro (Up)

1. Press and hold the “Up” button.
2. Press and release the “Reset” button.
3. Release the “Up” button.
4. Press “Down” or “Up” to move the text block.
5. When the choice is made, press and release the “Set” button.

Changing the Vertical Position

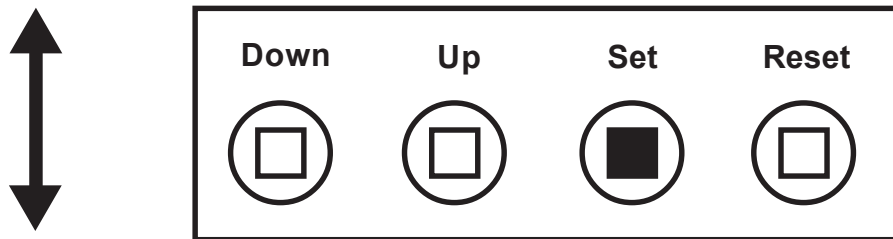

Figure 6: Four Front Panel Push-Buttons of VSSI-Pro (Set)

1. Press and hold the “Set” button.
2. Press and release the “Reset” button.
3. Release the “Set” button.
4. Press “Down” or “Up” to move the text block.
5. When the choice is made, press and release the “Set” button.

PROGRAMMING - GETTING STARTED

After you have completed the installation of the VSSI-Pro and any additional interfaces and cabling, follow the power-up sequence as described in the installation instructions for your specific device. Make sure that you have a video signal present from the camera that the VSSI-Pro is using. If all of this was successful, you will be presented with the following message on the video monitor screen:



If this message does not appear, go to the Problem Solving Guide on page 47. If at any time after the successful installation and programming of the VSSI-Pro you see the message “COMM PORT TIME OUT”, this means no data has been received for at least 30 seconds. This message will disappear as soon as the VSSI-Pro receives data again.

PROGRAMMING MENUS

To access the main-menu of the VSSI-Pro, simultaneously hold down the “Down” and “Up” buttons, press and release the “Reset” button, and then release the “Down” and “Up” buttons. This will take you to the main programming menu.

To navigate through this menu, press the “Down” or “Up” button to position the cursor in front of the desired item and then press “Set” to select the item and access any sub-menus for that item.

Within a sub-menu, press the “Down” or “Up” button and press “Set” again to select any items or change settings for a particular item.

If a sub-menu has an "EXIT" entry, always select it and press "Set". This will save the programmed settings in memory and return you to the previous menu. If you press “Reset” from a sub-menu, any programmed settings in that menu will not be saved in memory.

When finished programming the VSSI-Pro, return to the main-menu and press "Reset" to exit from the programming mode to the operation mode.

MAIN-MENU FOR PROGRAMMING

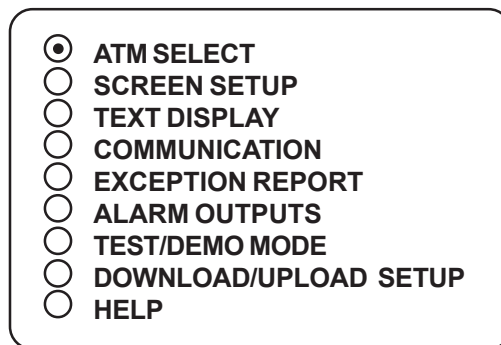

Figure 7: Main-Menu for Programming the VSSI-Pro

ATM SELECT

The following is a detailed description of the menu selections and the programming capabilities of the VSSI-Pro. It will bring up a sub-menu consisting of the following ATM configurations from which to choose the appropriate format for your machine:

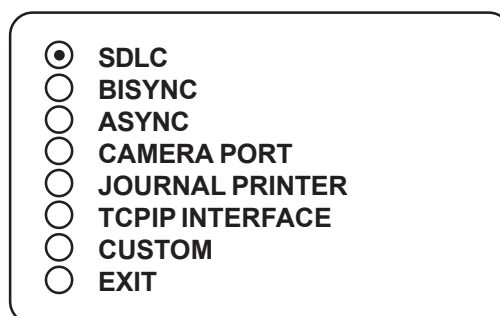

Figure 8: ATM SELECT Sub-Menu

Knowledge of the appropriate format to choose at this time would have been obtained before your purchase of the VSSI-Pro. But if you are unsure, you can simply try each format until you find the right one for your machine. To select a format, press the “Up” or “Down” button to move the cursor. For example, move the cursor to “SDLC” and press “Set”, then press the “Up” or “Down” button move the cursor to “SDLC FORMAT I” and press “Set”. An asterisk appears to indicate your selection. Next, press the “Up” or “Down” button to the cursor to “EXIT” and press “Set” to return to the previous menu. The word “SETUP” and the accompanying dots should appear. Within 1 to 3 minutes the dots should seem to move and the word “COMPLETED” will appear. If this does not happen, re-enter the main-menu and try another format. When the right format is chosen, the message “SETUP COMPLETED” will display. Return to the main-menu and continue programming.

PROGRAMMING THE VSSI-PRO

This sub-menu is selected when connecting to SNA or X.25 modem taps. The most common is FORMAT I but if the data does not display in a pleasing format try FORMAT II-IV. The CAT ELF is for the Citibank ATM network only.

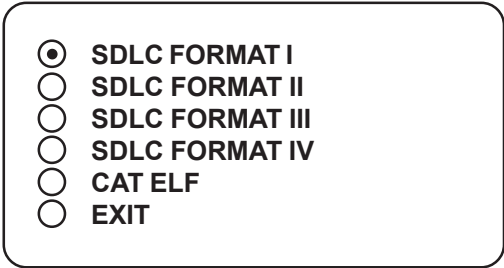

Figure 9: SDLC Sub-Menu

This protocol is the generic name for the IBM 3670 or 3675 communication standard *BISYNC* with the following sub-menu:



Figure 10: BISYNC Sub-Menu

The async format is for proprietary credit unions or older networks. This is the RS-232C standard *ASYNC* with the following sub-menu:



Figure 11: ASYNC Sub-Menu

The camera port provided on many ATMs was originally designed to connect to film cameras. Limited data is available on these ports but it is an easy method of interfacing. These ports must be enabled in the ATM setup or will not function so contact your ATM installer to verify. The data format is RS-232C with special handshaking camera port with the following sub-menu:

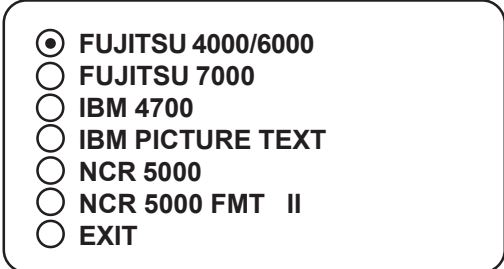

Figure 12: CAMERA PORT Sub-Menu

Journal printer taps take the data from the journal or receipt printer and displays that data. This data is either RS-232C or a proprietary variation thereof. Optional data converters are required for some printer interfaces.

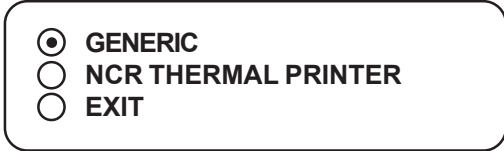

Figure 13: JOURNAL PRINTER Sub-Menu

The tap mode reads the data that is communicating to an installed printer. If the printer goes off line or runs out of paper no data will display. In the emulate mode, the VSSI-Pro simulates a printer and constantly tells the ATM the printer is on-line and full of paper.



Figure 14: NCR THERMAL PRINTERS Sub-Menu

TCPIP 232 Adapter

Interfacing the VSSI-Pro to the ATM TCP/IP network requires the TCPIP 232 Adapter along with the VSSI-Pro. The IP address of the ATM is programmed into the TCPIP 232 Adapter via on-screen programming. The ATM LAN cable is plugged into the adapter and the supplied additional LAN cable is then plugged into the ATM. Therefore this DOES NOT require an additional network port for the ATM interface or any host programming of a VPN router.



Figure 15: Front of TCPIP 232 Adapter

TCPIP 232 Adapter Connections

1. Remove the ATM LAN Cable which is connected direct to the ATM and then immediately plug it in to the TCPIP 232 Adapter. Loop the LAN cable which came with TCPIP 232 Adapter via the RJ-45 Port on the TCPIP 232 Adapter rear panel to the ATM. Delay in doing this might cause the ATM to go off-line. If this happens then wait for the ATM to automatically come back on-line.
2. Connect the VSSI-Pro to the TCPIP 232 Adapter using the TCPIP 232-to-VSSI-Pro cable.
3. Connect the camera and video output cable to the monitor or DVR.
4. Power up your system to program VSSI-Pro.

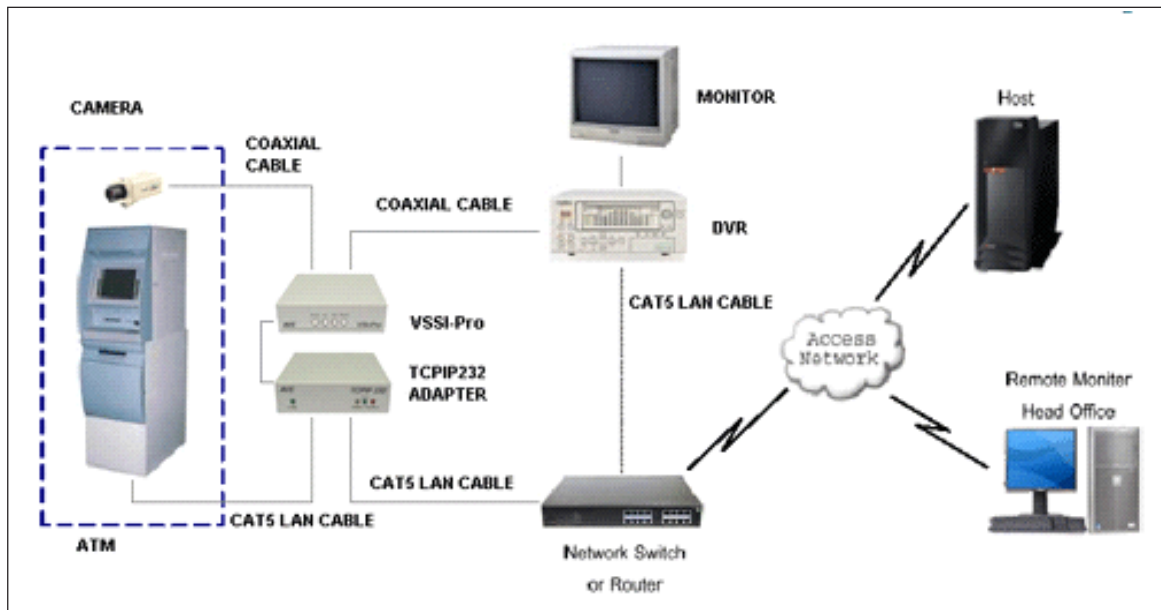

Figure 16: TCPIP 232 Adapter Connections

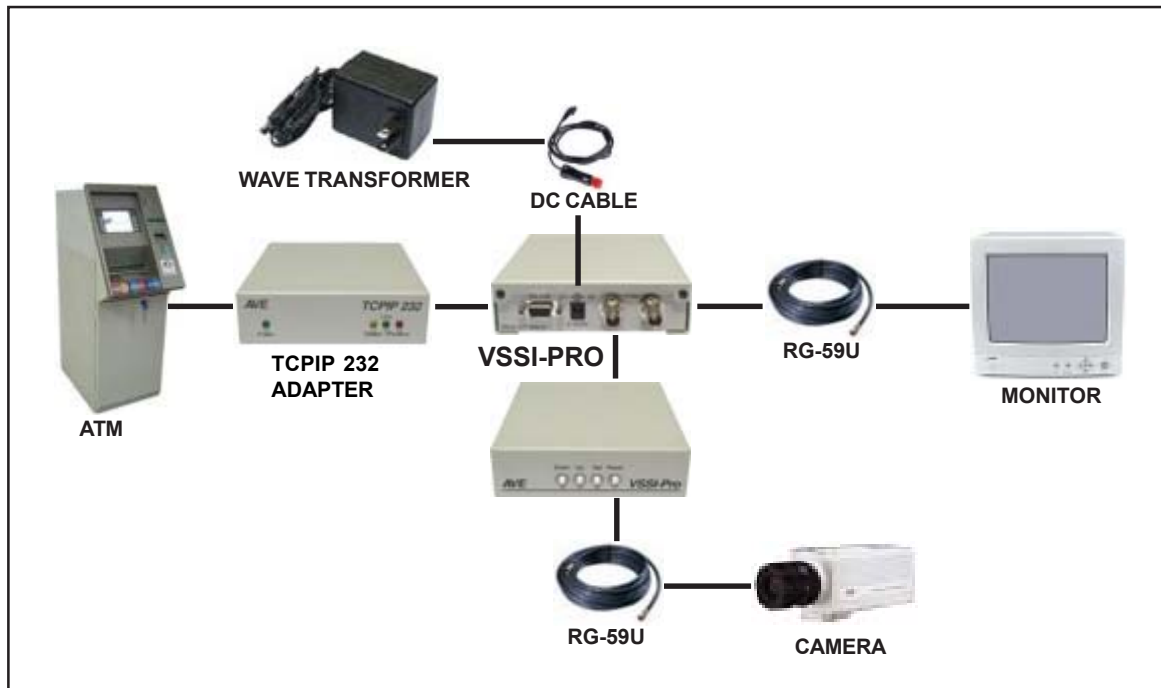

Figure 17: VSSI-Pro Connections with TCPIP 232 Adapter

PROGRAMMING THE VSSI-PRO

The TCPIP INTERFACE sub-menu:



Figure 18: TCPIP INTERFACE Sub-Menu

1. Press the “Up” or “Down” button to move the cursor to “TCPIP FORMAT I” and press “Set” to enter and change the IP address to the same as ATM’s IP address.

EXAMPLE: If the ATM’s IP address is 192.168.0.141, set the address on the TCPIP 232 Adapter using this menu.

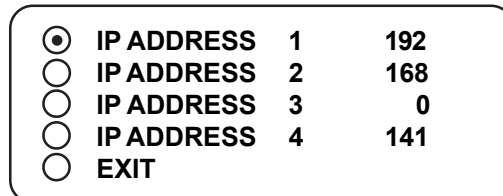

Figure 19: TCPIP FORMAT I Sub-Menu

2. Press the “Up” or “Down” button to move the cursor to “EXIT” and press “Set” to return to the previous menu.
3. Test your transaction on the ATM to verify the VSSI-Pro and TCPIP 232 Adapter’s operation.

TCPIP 232 DEBUGGING MODE

In the TCPIP DEBUGGING mode, the data from the network will display on the monitor. However, the VSSI-Pro has a limited buffer size so if you connect to a busy network and the buffer is overrun, then data will be lost. For normal ATM data, the buffer is sufficient but care must be taken in monitoring the buffer status when doing data dumps. This is useful to verify the TCPIP 232 Adapter is connected properly and sending data to the VSSI-Pro.



Figure 20: TCPIP INTERFACE Sub-Menu

1. Press the “Up” or “Down” button to move the cursor to “TCPIP DEBUGGING” and press “Set” to enter and change the IP address to the same as the ATM’s IP address.

EXAMPLE: If the ATM’s IP address is 192.168.0.141, set the address on the TCPIP 232 Adapter using this menu.

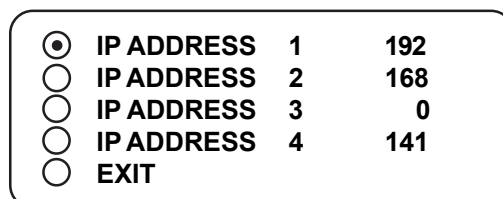

Figure 21: TCPIP DEBUGGING Sub-Menu

2. Once you select the IP address, press the “Up” or “Down” button to move the cursor to “EXIT” and press “Set” to return to the the previous menu.

TCPIP 232 ADAPTER LED INDICATOR

| | | |
|--------|-------|--|
| GREEN | POWER | TCPIP 232 Power Status |
| RED | REC | EIVETCPIP-232 Receive Data from ATM |
| GREEN | LINK | ATM Status, On = Ready / Off = Not ready |
| YELLOW | SPEED | Off = 10 Mbps, On = 100 Mbps Ethernet |



VSSI-Pro VIDEO SERIAL ATM INTERFACE

CUSTOM

The custom settings are for special programming done for various customers to format the display or to interface to a proprietary network exclusive to that customer. The following sub-menu will appear:

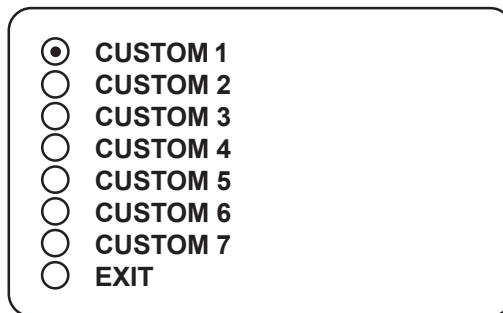

Figure 22: CUSTOM Sub-Menu

SCREEN SETUP

On the main-menu, press the “Up” or “Down” button to move the cursor to “SCREEN SETUP” and press “Set”. The following sub-menu will appear:

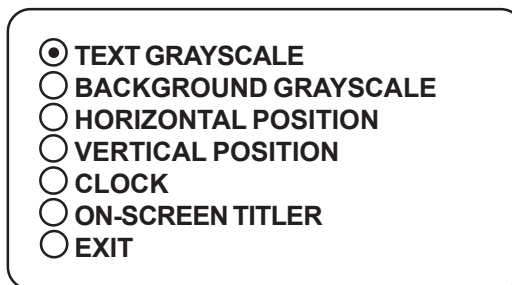

Figure 23: SCREEN SETUP Sub-Menu

TEXT GRAYSCALE

To change the gray scale of the on-screen text, press the “Up” or “Down” button to move the cursor to “TEXT GRAYSCALE” and press “Set”. Cycle through the selection by pressing the “Up” or “Down” buttons. There are 8 levels to choose from. Make your selection and press “Set” to return to the previous menu.

BACKGROUND GRAYSCALE

To change the gray scale of the background of the on-screen text, press the “Up” or “Down” button to move the cursor to “BACKGROUND GRAYSCALE” and press “Set”. Cycle through the selection by pressing the “Up” or “Down” buttons. There are 8 settings to choose from. Make your selection and press “Set” to return to the previous menu.

HORIZONTAL POSITION

To change the horizontal position of the inserted on-screen text, press the “Up” or “Down” button to move the cursor to “HORIZONTAL POSITION” and press “Set”. Press the “UP” or “DOWN” buttons to move the text to the desired position.

VERTICAL POSITION

To change the vertical position of the inserted on-screen text, press the “Up” or “Down” button to move the cursor to “VERTICAL POSITION” and press “Set”. Press the “Up” or “Down” buttons to move the text to the desired position.

PROGRAMMING THE VSSI-PRO

CLOCK

To program the clock's functions, use the "Up" and "Down" buttons to move the cursor to "CLOCK" and press "Set". The following sub-menu will appear:

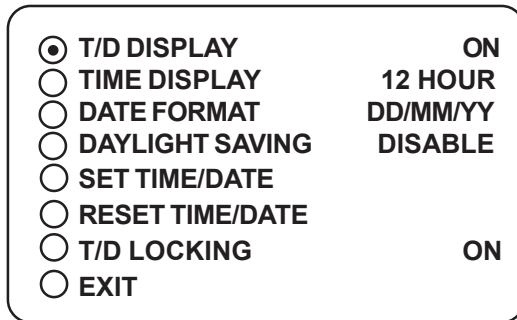

Figure 24: CLOCK Sub-Menu

NOTE 

Enabling the clock limits the number of display lines to 10 maximum.

T/D DISPLAY turns the time/date display on or off. Press the "Up" or "Down" button to move the cursor to "T/D DISPLAY" and press "Set". The cursor will start flashing. Press the "Up" or "Down" button to toggle between "ON" or "OFF" and press "Set" when the desired value is displayed.

TIME DISPLAY selects either 12-hour AM/PM or 24-hour Military Time format with AM/PM. Press the "Up" or "Down" button to move the cursor to "TIME DISPLAY" and press "Set". The cursor will start flashing. Press the "Up" or "Down" button to toggle between time formats and press "Set" when the desired format is displayed.

DATE FORMAT chooses one of the three available formats. Press the "Up" or "Down" button to move the cursor to "DATE FORMAT" and press "Set". The cursor will start flashing. Press the "Up" or "Down" button to toggle between date formats and press "Set" when the desired format is displayed.

DAYLIGHT SAVING selects, for example, USA, Canada, Australia or is disabled. Press the "Up" or "Down" button to move the cursor to "DAYLIGHT SAVING" and press "Set". The cursor will start flashing. Press the "Up" or "Down" button to toggle between values and press "Set" when the desired value is displayed.

SET TIME/DATE sets the clock manually. Press the "Up" or "Down" button to move the cursor to "SET TIME/DATE" and press "Set". The time/date will appear and the cursor will start flashing. Press the "Up" and "Down" button to change the value and press "Set" when the desired value is displayed. The value is selected and the cursor will advance to the next position. When the desired time/date is displayed, press the "Up" and "Down" buttons simultaneously to enter the time/date into memory and return to the previous menu.

RESET TIME/DATE resets the clock to the default value. Press the "Up" or "Down" button to move the cursor to "RESET TIME/DATE" and press "Set" to reset the time/date.

T/D LOCKING turns the time/date locking on or off. If the time/date locking is turned on, make sure that the time and date format selected is the same as the ATM time and date format. Press the "Up" or "Down" button to move the cursor to "T/D LOCKING" and press "Set". The cursor will start flashing. Press the "Up" or "Down" button to toggle between "ON" or "OFF" and press "Set" when the desired value is displayed.

MORE ON TIME/DATE LOCKING

If the time/date locking is turned on, the VSSI-Pro will monitor the incoming data string. If it finds a valid time and date in one or two consecutive lines, it will set the clock to whatever time/date it finds. A valid time has the following formats:

*hh:mm, hh:mm:ss
 hh:mmAM, hh:mm:ssAM
 hh:mmPM, hh:mm:ssPM*

where hh is a number between 0 and 24 or 0 and 12 if either AM or PM is present.

A valid date has the same format as for the date display of the host and can have either '/' or '-' as a separator.

EXIT

When finished programming the clock's functions, press the "Up" or "Down" button to move the cursor to "EXIT" and press "Set" to return to the previous menu.

ON-SCREEN TITLER

Press the "Up" or "Down" button to move the cursor to "ON-SCREEN TITLER" and press "Set". The following sub-menu will appear:

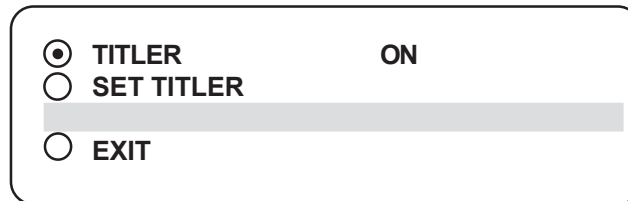

Figure 25: ON-SCREEN TITLER Sub-Menu

TITLER

Choices: ON, OFF

Press the "Up" or "Down" button to move the cursor to "TITLER" and press "Set". The cursor will start flashing. Press the "Up" or "Down" button to toggle between "ON" or "OFF" and press "Set" when the desired value is displayed.

SET TITLER

The VSSI-Pro gives you the option of a 20-character display for easy ATM identification in addition to the actual ATM transaction data. To create a title, press the "Up" or "Down" button to move the cursor to "SET TITLER" and press "SET". You will see a row of 20 boxes with the first position flashing. To change the character in the first position, press the "UP" or "DOWN" button to cycle through the alphanumeric selections from the following list of available characters:

**ABCDEFGHIJKLMNOPQRSTUVWXYZ
 abcdefghijklmnopqrstuvwxyz=: . +-* / ^ 9876543210®**

The solid white box is used for a blank space. When the desired value is displayed, press "Set". The value is selected and the cursor will advance to the next position. Repeat until you have entered the desired title. To erase a character in the current position, press the "Up" and "Set" buttons simultaneously.

PROGRAMMING THE VSSI-PRO

When the desired time/date is displayed, press the “Up” and “Down” buttons simultaneously to enter the title into memory and return to the menu.

The white boxes will disappear and your title will be displayed as it will appear on-screen.

NOTE 

Remember, enabling the titler will limit text insertions to 10 lines maximum, and with the clock on then 9 maximum.

EXIT

Press the “Up” or “Down” button to move the cursor to “EXIT” and press “Set” to return to the previous menu.

TEXT DISPLAY

This menu will give you more control over the actual text block formatting and its appearance on-screen. On the main-menu, press the “Up” or “Down” button to move the cursor to “TEXT DISPLAY” and press “Set”. The following sub-menu will appear:

| | | |
|----------------------------------|----------------|-----|
| <input checked="" type="radio"/> | SCREEN BLANK | 20 |
| <input type="radio"/> | DISPLAY LINES | 10 |
| <input type="radio"/> | DISPLAY FORMAT | TOP |
| <input type="radio"/> | LINE COMPRESS | ON |
| <input type="radio"/> | LEFT JUSTIFIED | ON |
| <input type="radio"/> | SCROLL DELAY | ON |
| <input type="radio"/> | DISPLAY | ON |
| <input type="radio"/> | EXIT | |

Figure 26: TEXT DISPLAY Sub-Menu

SCREEN BLANK

Choices: NONE, 6, 12, 20, 30, 60, 120, 180, 300 (in seconds)

This is the amount of time that the VSSI-Pro text display will remain on-screen after a transaction before blanking itself off (not the video picture, just the ATM transaction data) until the next transaction.

Press the “Up” or “Down” button to move the cursor to “SCREEN BLANK” and press “Set”. The cursor will begin flashing. Press the “Up” or “Down” button to move the cursor to cycle through the selections. Press the “Up” or “Down” button to cycle through the values and press “Set” when the desired value is displayed.

NOTE 

Choosing “NONE” means no blanking. The VSSI-Pro will display the last transaction until a new transaction is performed and over-writes the previous transaction.

DISPLAY LINES

Choices: 1 through 11

You have the choice of how many lines of text to display on-screen for register transactions. The choices are 1 through 11. Press the “Up” or “Down” button to move the cursor to “DISPLAY LINES” and press “Set”. The cursor will begin flashing. Press the “Up” or “Down” button to cycle through the values and press “Set” when the desired value is displayed.

NOTE 

All ATM transaction data will scroll up regardless of the number of lines you choose to display on-screen. The more lines you display on-screen, the greater the amount of time that the transaction data will take to be recorded. However, some applications may limit the number of lines and the size of the on-screen display. Note: If you are using an on-screen title, it will occupy Line 1, leaving 10 lines for the text insertion.

LINE COMPRESS

Choices: ON, OFF

The VSSI-Pro automatically compresses the spaces in a line first as it reaches 20 characters. With LINE COMPRESS on, the VSSI-Pro will additionally remove multiple spaces and vowels from the text to further compress the display as necessary. Press the “Up” or “Down” button to move the cursor to “LINE COMPRESS” and press “Set”. The cursor will start flashing. Press the “Up” or “Down” button to cycle through the values and press “Set” when the desired value is displayed.

LEFT JUSTIFIED

Choices: ON, OFF

When LEFT JUSTIFIED is on, the VSSI-Pro will start each line of text with no leading spaces from the left margin of the text display block. Press the “Up” or “Down” button to move the cursor to “LEFT JUSTIFIED” and press “Set”. The cursor will start flashing. Press the “Up” or “Down” button to toggle between “ON” or “OFF” and press “Set” when the desired value is displayed.

SCROLL DELAY

Choices: ON, OFF

Scroll delay ensures that lines of text remain on screen a minimum of 0.5 seconds. This is especially useful with ATMs that run at a high baud rate, time-lapse VCR’s or DVRs in extended record modes, switchers, or multiplexers. Sometimes the ATM can produce characters so quickly that they can scroll up too fast on the screen to be recorded.

When SCROLL DELAY is on, the VSSI-Pro slows down this data feed just enough to insure that each line of text is recorded. Press the “Up” or “Down” button to move the cursor to “SCROLL DELAY” and press “Set”. The cursor will start flashing. Press the “Up” or “Down” button to toggle between “ON” or “OFF” and press “Set” when the desired value is displayed.

PROGRAMMING THE VSSI-PRO

DISPLAY

Choices: ON, OFF

You have the choice to globally turn on or off the complete VSSI-Pro text insertion function. This means no data will be visible on the monitor if you select DISPLAY “OFF”. However, if you select the DISPLAY “OFF”, you can still command each exception independently to either display on-screen or not through its program setup sub-menu under EXCEPTION REPORTS. You may also choose to enable an alarm output to occur during an exception while not displaying the exception data through its program setup sub-menu in ALARM OUTPUTS. With DISPLAY “OFF”, the VSSI-Pro will still perform all functions as programmed. For example, exception reporting will still function but the information will not appear on-screen unless programmed to do so in the EXCEPTIONS REPORT sub-menu.

NOTE  *If the data does not display on the screen, it will not be saved in the Exception History.*

EXIT

Press the “Up” or “Down” button to move the cursor to “EXIT” and press “Set” to return to the previous menu.

COMMUNICATION

When you choose your format in the ATM SELECT sub-menu, it automatically formats the VSSI-Pro to the appropriate settings needed to communicate with the ATM; therefore it may not be necessary for you to enter this menu at all. But there may be times when you will need to amend these settings for specific applications or testing purposes. If you want to amend the settings for the chosen format, on the main-menu, press the “Up” or “Down” button to move the cursor to “COMMUNICATION” and press “Set”. The following sub-menu will appear:



Figure 27: COMMUNICATION Sub-Menu

PORT 1

Press the “Up” or “Down” button to move the cursor to “PORT 1” and press “Set”. The following sub-menu will appear:

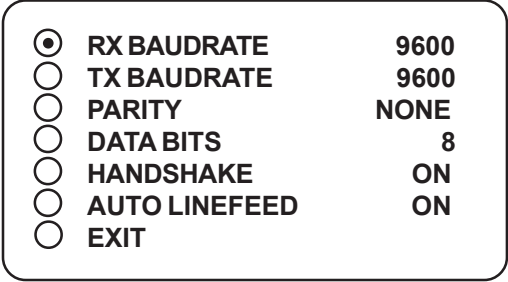

Figure 28: PORT 1 Sub-Menu

RX BAUDRATE

Choices: AUTO, 150, 300, 600, 1200, 2400, 4800, 9600, 14.4K, 19.2K, 28.8K, 38.4K. The default is 2400.

Press the “Up” or “Down” button to move the cursor to “RX BAUDRATE” and press “Set”. The cursor will start flashing. Press the “Up” or “Down” button to cycle through the values and press “Set” when the desired value is displayed. Note that changing the RX BAUDRATE value simultaneously changes the TX BAUDRATE value.

TX BAUDRATE

This feature allows you to set the transmit baud rate to a separate device if you are looping the data back out of the VSSI-Pro. The TX BAUDRATE value is changed simultaneously when changing the RX BAUDRATE value.

PARITY

Choices: NONE, ODD, EVEN

Press the “Up” or “Down” button to move the cursor to “PARITY” and press “Set”. The cursor will start flashing. Press the “Up” or “Down” button to toggle between values and press “Set” when the desired value is displayed.

DATA BITS

Choices: 7 or 8

If you select 7 data bits, you must select “ODD” or “EVEN” parity in the PARITY menu. Press the “Up” or “Down” button to move the cursor to “DATA BITS” and press “Set”. The cursor will start flashing. Press the “Up” or “Down” button to toggle between values and press “Set” when the desired value is displayed.

HANDSHAKE

Choices: ON, OFF

Handshaking is an electrical signal that tells the ATM or external device that the VSSI-Pro is ready to receive data. Handshaking may not be necessary and/or may be connected to an outgoing signal from the external device since the VSSI-Pro does not require it. The VSSI-Pro's handshaking signal is always present. Handshaking guarantees that the internal buffer is not over-run or that text is not lost. The AVE Networker or Vnetworker supports this protocol but most other AVE interfaces do not support this function. Press the “Up” or “Down” button to move the cursor to “HANDSHAKING” and press “Set”. The cursor will start flashing. Press the “Up” or “Down” button to toggle between “ON” or “OFF” and press “Set” when the desired value is displayed.

AUTO LINEFEED

Choices: ON, OFF

AUTO LINEFEED makes the VSSI-Pro send out CR/LF after each line. The default for this function is ON. Press the “Up” or “Down” button to move the cursor to “AUTO LINEFEED” and press “Set”. The cursor will start flashing. Press the “Up” or “Down” button to toggle between “ON” or “OFF” and press “Set” when the desired value is displayed.

EXIT

Press the “Up” or “Down” button to move the cursor to “EXIT” and press “Set” to return to the previous menu.

PROGRAMMING THE VSSI-PRO

PORT A : B

Again, there is probably no need for you to access this menu as it should be used for testing purposes only. You should rely on the setting chosen in ATM SELECT, but we will provide a brief overview of this menu. Press the “Up” or “Down” button to move the cursor to “PORT A : B” and press “Set”. The following sub-menu will appear:



Figure 29: Port A : B Sub-Menu

ASYNC

Press the “Up” or “Down” button to move the cursor to “ASYNC” and press “Set”. The following sub-menu will appear:



Figure 30: ASYNC Sub-Menu

ADDRESS SETUP

Choices: ANY, 1 through 254

Press the “Up” or “Down” button to move the cursor to “ADDRESS SETUP” and press “Set”. The cursor will start flashing. Press the “Up” or “Down” button to toggle between values and press “Set” when the desired value is displayed.

BAUD RATE

Choices: 1200, 2400, 4800, 9600, 14.4K, 19.2K, 28.8K, 38.4K, 57.6K, 115.2K

Press the “Up” or “Down” button to move the cursor to “BAUD RATE” and press “Set”. The cursor will start flashing. Press the “Up” or “Down” button to cycle through the values and press “Set” when the desired value is displayed.

PARITY

Choices: NONE, EVEN, ODD

Press the “Up” or “Down” button to move the cursor to “PARITY” and press “Set”. The cursor will start flashing. Press the “Up” or “Down” button to toggle between values and press “Set” when the desired value is displayed.

DATA BITS

Choices : 7 or 8

Press the “Up” or “Down” button to move the cursor to “DATA BITS” and press “Set”. The cursor will start flashing. Press the “Up” or “Down” button to toggle between values and press “Set” when the desired value is displayed.

In addition to each item in this sub-menu and in the sub-menus for BISYNC and SDLC will be the settings for these formats, one of which you chose in the ATM SELECT sub-menu. The address settings are ASYNC or 0 through 254. BAUD RATE choices are from 1200 to 115200. PARITY choices are NONE, EVEN, and ODD. DATA BITS can be 7 or 8. Do not change these settings except for specific applications or for troubleshooting purposes.

BISYNC

Press the “Up” or “Down” button to move the cursor to “BISYNC” and press “Set”. The following sub-menu will appear:

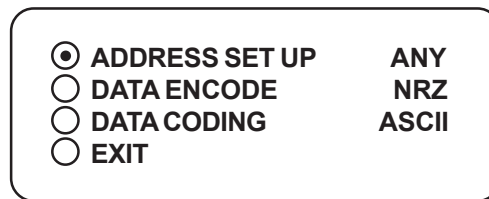

Figure 31: BISYNC Sub-Menu

ADDRESS SETUP

Choices : ANY, 1 through 254

Press the “Up” or “Down” button to move the cursor to “ADDRESS SETUP” and press “Set”. The cursor will start flashing. Press the “Up” or “Down” button to toggle between values and press “Set” when the desired value is displayed.

DATA ENCODE

Choices : NRZ, NRZI, NRZID

Press the “Up” or “Down” button to move the cursor to “DATA ENCODE” and press “Set”. The cursor will start flashing. Press the “Up” or “Down” button to toggle between values and press “Set” when the desired value is displayed.

DATA CODING

Choices : ASCII or EBCDIC

Press the “Up” or “Down” button to move the cursor to “DATA ENCODE” and press “Set”. The cursor will start flashing. Press the “Up” or “Down” button to toggle between values and press “Set” when the desired value is displayed.

SDLC

Press the “Up” or “Down” button to move the cursor to “SDLC” and press “Set”. The following sub-menu will appear:

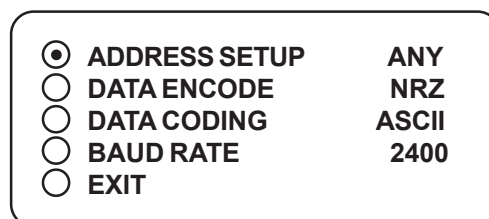

Figure 32: SDLC Sub-Menu

NOTE

Added to DATA ENCODE in this sub-menu is the choice of AUTO along with NRZ, NRZI, NRZID. Otherwise the settings available are the same as in the BISYNC or ASYNC menus.

EXIT

Press the "Up" or "Down" button to move the cursor to "EXIT" and press "Set" to return to the previous menu.

EXCEPTION REPORT

The Exception Report gives you the option to assign an on-screen flag, trigger an alarming device, or send data to another serial device on any questionable transaction that you have preprogrammed into the VSSI-Pro. The VSSI-Pro will allow programming of up to 24 separate exceptions. These exceptions can be any transaction that you determine to be "exceptional" or questionable.

You may even set ranges for some exceptions. For example, all transactions over \$100, between \$8.00 and \$25.00, or lower than \$10.00 and greater than \$10.00. Exceptions can be set by a specific customer or what ever type of transaction you need to watch "exceptionally" close.

The following is a brief overview of how to set up Exception Reports.

1. On the main-menu, press the "Up" or "Down" button to move the cursor to "EXCEPTION REPORT" and press "Set".
2. On the sub-menu, press the "Up" or "Down" button to move the cursor to "EXCEPTION HISTORY" and press "Set".
3. On the sub-menu, press the "Up" or "Down" button to move the cursor to "DVR SELECTION" and press "Set". Then select the model of DVR you are using.
4. Exit and press the "Up" or "Down" button to move the cursor to "SET EXCEPTION" and press "Set".
5. To select the Exception No. that you wish to program, press the "Up" or "Down" button to move the cursor to the desired Exception No. then press "Set". Press the "Up" or "Down" button to toggle between the choices.
6. Make sure that "DISPLAY" is set to "ON" for any exception data to be saved in the Exception History.
7. Program the Exception String in the Exception Report to compare the data that shows on the screen for time search mode in the Exception History menu.
8. After you have set up the desired configurations, press the REC button on the DVR to record video into a hard drive or use alarm output for triggering the DVR at record input.
9. The monitor should display a flashing REC message and the REC button will light up indicating the DVR is in the recording mode.

ON-SCREEN FLAGS

You have several options for programming your Exception Report. The first option typically has all programmed exceptions display a flashing asterisk in the upper right corner of the on-screen display. This on-screen flag is controlled through the ALARM OUTPUTS menu. You assign a corresponding alarm to an exception and set the parameters for the flag in this menu. You do this by choosing "DISPLAY" for the corresponding exception number and selecting "ON". With this option, all questionable transactions (exceptions) will be "flagged" with the flashing asterisk. You can then review these exceptions by putting your DVR or VCR in play and pressing the FF button. This will give you a fast scan of the recording and you can go into normal play when you see the flashing asterisk and view that transaction in real-time or slow play or frame by frame depending on the type of playback options of your particular DVR or VCR.

HARD ALARM OUTPUT

The VSSI-Pro allows you to program exceptions to trigger external alarming devices such as DVRs, time-lapse VCR's, Quads, Enunciators, LED's, etc. Using the alarm output you can have your recorder record only exceptions, or have an alarming Quad go to full-screen on an exception, or even trigger a buzzer to alert you that an exception has occurred.

PRINTER or DVR OUTPUT

There may be situations where you do not want tellers or other employees to know what triggers an exception. In this case, the VSSI-Pro provides a separate output that will send data to a remotely located serial printer. If you turn the on-screen display off and the output on and you have a remote serial printer hooked up to the VSSI-Pro, then whenever an exception is reported it is sent out to the serial printer only. The printer will give you a hard copy printout of the questionable transaction with the time and date. With this hard copy printout of the exception report, you can then review the recording by going directly to that exception's time.

The serial printer output of the VSSI-Pro can be programmed to send out the entire transaction. The output can be connected to other equipment such as DVRs, phone line transmissions, or digital storage devices for later retrieval or using search functions built into these devices.

On the main-menu, press the "Up" or "Down" button to move the cursor to "EXCEPTION REPORT" and press "Set". The following sub-menu will appear:

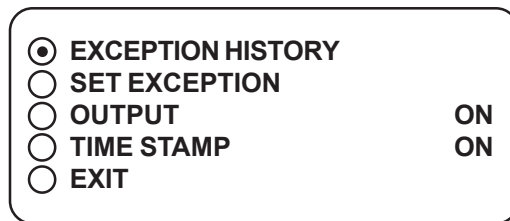

Figure 33: EXCEPTION REPORT Sub-Menu

EXCEPTION HISTORY

Press the "Up" or "Down" button to move the cursor to "EXCEPTION HISTORY" and press "Set". The following sub-menu will appear:

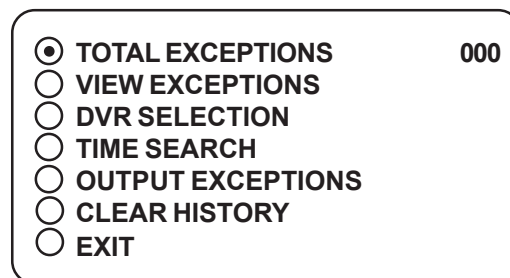

Figure 34: EXCEPTION HISTORY Sub-Menu

TOTAL EXCEPTIONS

This is not a selection, it simply displays the total exception count kept in the Exception History Buffer.

VIEW EXCEPTIONS

This displays the buffered exceptions on-screen, starting with the oldest exception in the buffer. Press the "Up" or "Down" button to move the cursor to "VIEW EXCEPTIONS" and press "Set". Once in the exception displaying screen, press the "Up" or "Down" button to scroll to the next screen. Press "Set" to exit and return to the previous menu. Remember, you must turn the DISPLAY "ON" for exceptions to be saved in history.

PROGRAMMING THE VSSI-PRO

Example:

Define "WITHDRAWAL" as an exception string in Exception No. 2 with the DISPLAY "ON" and define RANGE "100.00-1000.00" and define OPERATOR "IN".

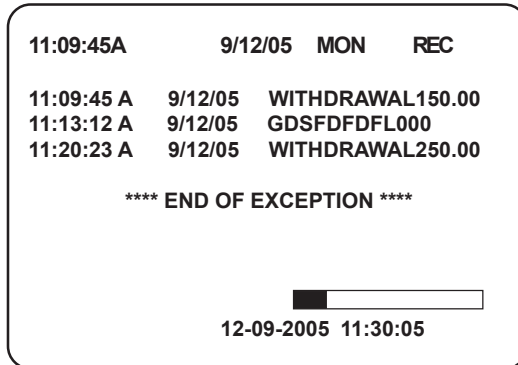

Figure 35: VIEW EXCEPTIONS Display

NOTE

For any exception you must program DISPLAY "ON" for any exception data to be saved in the Exception History.

DVR SELECTION

Press the "Up" or "Down" button to move the cursor to "DVR SELECTION" and press "Set". The following sub-menu will appear:

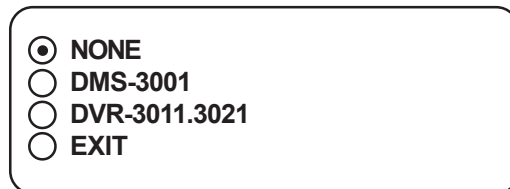

Figure 36: DVR SELECTION Sub-Menu

The default setting is "NONE". If there is no DVR connected to the VSI-PRO, keep this selection.

DVR-3011 / DVR-3021

Press the "Up" or "Down" button to move the cursor to "DVR -3011.3021" and press "Set". An asterisk appears to indicate your selection.

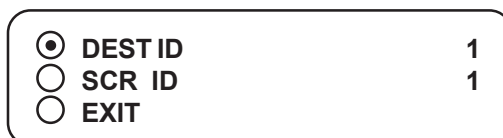

Figure 37: DVR-3011.3021 Sub-Menu

DEST ID and SRC ID

Choices: 1 through 32

Press the “Up” or “Down” button to move the cursor to “DEST ID” or “SCR ID” and press “Set”. The cursor will start flashing. Press the “Up” or “Down” button to toggle between values and press “Set” when the desired value is displayed.

EXIT

Press the “Up” or “Down” button to move the cursor to “EXIT” and press “Set” to return to the previous menu.

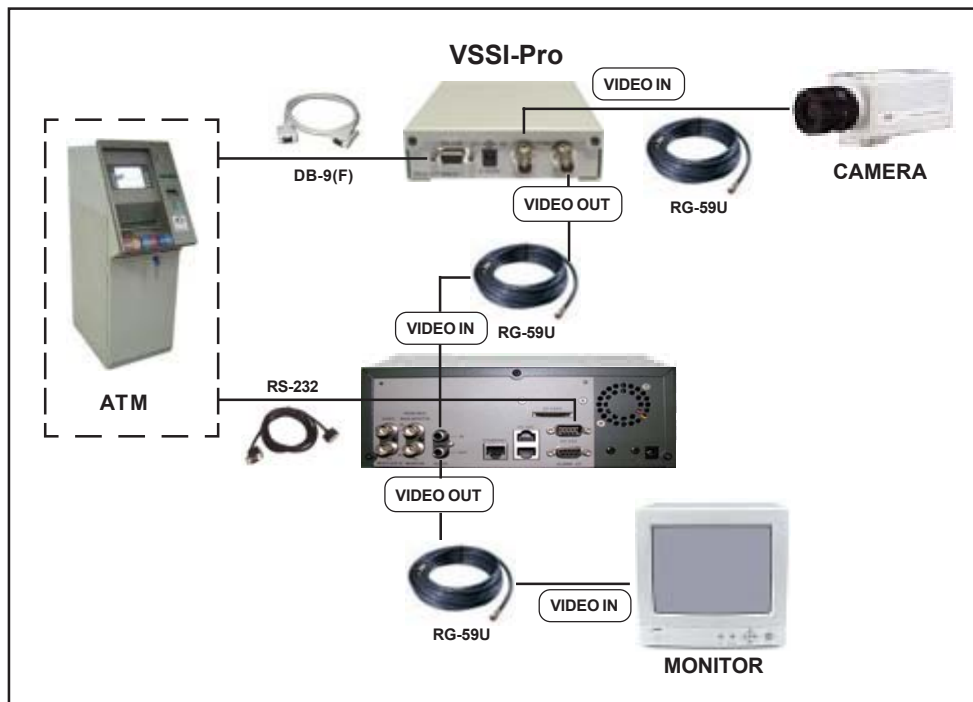

Figure 38: VSSI-Pro with DVR Connections

PROGRAMMING THE VSSI-PRO

TIME SEARCH

TIME SEARCH SETTING

NOTE

For any exception you must program Display "ON" for any exception data to be saved in the Exception History.

USING TIME SEARCH FUNCTION

1. Press the "Up" or "Down" button to move the cursor to "TIME SEARCH" and press "Set". The following sub-menu will appear:

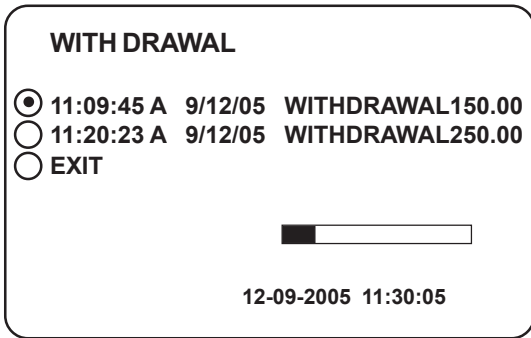

WITH DRAWAL

11:09:45 A 9/12/05 WITHDRAWAL150.00

11:20:23 A 9/12/05 WITHDRAWAL250.00

EXIT

12-09-2005 11:30:05

Figure 39: TIME SEARCH Sub-Menu

2. Press the "Up" or "Down" button to move the cursor to the data item that you want to search at that time.

Example:

Define "WITHDRAWAL" as an exception string in Exception No. 2 with the DISPLAY "ON" and define RANGE "100.00-1000.00" and define OPERATOR "IN".

If the screen is displayed "WITHDRAWAL", the VSSI-Pro will keep this displayed line on Exception History.

OUTPUT EXCEPTIONS

This selection allows you to have the buffered exceptions sent out for printing. This is a global setting for all exceptions, but you also need to turn on the output for each independent exception.

CLEAR HISTORY

This selection clears all the buffered exceptions and resets the TOTAL EXCEPTIONS counter.

EXIT

Returns you back to the EXCEPTION REPORT menu.

SET EXCEPTION

Press the “Up” or “Down” button to move the cursor to “SET EXCEPTION” and press “Set”. The following sub-menu will appear:

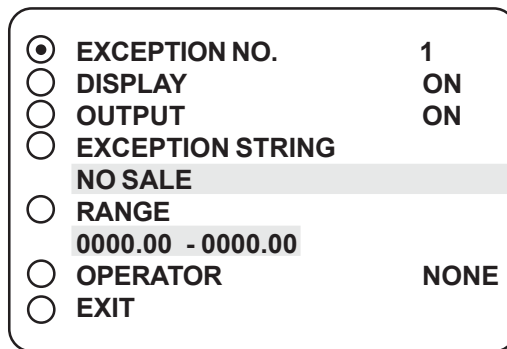

Figure 40: SET EXCEPTION Sub-Menu

NOTE 

For any exception you must program DISPLAY “ON” for any exception data to be saved in the Exception History.

To select the Exception No. that you wish to program, press the “Up” or “Down” button to move the cursor to “EXCEPTION NO.” and press “Set”. The cursor will start flashing. Use the “Up” & “Down” button to sequence through the choices. Make your selection and press “Set”. The cursor will stop flashing and you may continue to the next menu item.

EXCEPTION NO.

Choices: 1 through 24

NOTE 

Two Exception Strings, Nos. 23 & 24, are preprogrammed for beginning and ending transactions and with DISPLAY “OFF”. The display messages for these two exceptions are “TRANSACTION BEGIN” and “TRANSACTION END”, which means that when a transaction starts, an on-screen alarm is triggered and the “TRANSACTION BEGIN” message will be sent out, but not displayed, and the same will occur at the end of a transaction. You can display either of these messages by turning DISPLAY for these numbers “ON”.

PROGRAMMING THE VSSI-PRO

DISPLAY

Choices: ON, OFF

This display item lets you control whether or not a particular exception is displayed on the video monitor or not. If you do not turn on the exceptions display here, you will not have the on-screen flag and consequently no record of the exception when it occurs.

To make your selection, press the "Up" or "Down" button to move the cursor to "DISPLAY" and press "Set". The cursor will start flashing. Press the "Up" or "Down" button to toggle between "ON" or "OFF". Make your selection and press "Set". The cursor will stop flashing and you may continue to the next menu item.

APPLICATION NOTE

If the display of the exception is turned off here, the exception data will actually be erased from the screen. This feature can be used to generate what we refer to as "Negative Exceptions", allowing the removal of unwanted text from the screen. See "Negative Exceptions" that follows.

OUTPUT

Choices: ON, OFF

The OUTPUT controls the RS-232 data from the VSSI-Pro. Typically this is sent to a remote serial printer to provide a hard copy of the exceptions with time and date generated by the remote printer. This data can also be sent out to a computer with the appropriate software and give you the ability to analyze the data. You could use an auto answer modem and have the data sent to a central office or even to your home. The serial device must have the same baud rate, parity, and data bits as the VSSI-Pro (Port 1) in order for it to receive the data from the VSSI-Pro.

The pin-out from the VSSI-Pro DB-9 connector is: PIN 8, Transmit Data; and PIN 5, Ground. To make your selection, press the "Up" or "Down" button to move the cursor to "OUTPUT" and press "Set". Press the "Up" or "Down" button to toggle between "ON" or "OFF". Make your selection and press "Set". The cursor will stop flashing and you may continue to the next menu item.

PROGRAMMING NOTE

The following sections define the Exception String, the Operator, and the Range. The Exception String is programmed first, then the Range is defined, and finally the Operator is selected. The VSSI-Pro looks at the Exception String first, and if there is data that matches, it then checks to see if a Range has been defined.

NOTE

Only 20 characters are allowed in each exception string including blank spaces.

EXCEPTION STRING

The VSSI-Pro compares the data that is printed to video to the data entered in the Exception String. The Exception String can also be used without a defined range. An example of this would be to assign the word "DEPOSIT" as an exception. Because the VSSI-Pro will only be looking for this exception string, no range is needed. However, the exception string "DEPOSIT" could be further defined by assigning a range, for example, all DEPOSITS over \$100.00.

You can also define a global exception to flag all negative transactions. An example of this would be the following exception to flag any transaction that contains a "-", or negative sign.

WILDCARD: The wildcard symbol “•”, a centered dot, excepts on any data in that position.

Press the “Up” or “Down” button to move the cursor to “EXCEPTION STRING” and press “Set”. The first position of the 20 character exception will become active by flashing. Program in your exception string.

NOTE 

Remember to enter your exception string based on the way the data prints to video, including spaces, and remember pressing “Set” advances to the next position. Pressing “Down” and “Up” at the same time enters the string into memory and returns to the menu for further programming.

TIP 

If you make a mistake and need to erase a character, pressing “Up” and “Set” at the same time will change the character back to a blank space.

NEGATIVE EXCEPTIONS

You can remove unwanted text from the screen using your VSSI-Pro. The VSSI-Pro displays data in a text block 9 lines by 20 characters wide for a total of 180 characters. To remove unwanted messages from the register data you must first determine how the unwanted message prints to video, for example, a typical message which scrolls on the customer display or appears on the video monitor:

WELCOME TO BANK OF AMERICA.

To remove this message we will use a technique referred to as “negative exceptions”.

In the EXCEPTION REPORT sub-menu Exception 1 is defaulted to “NO SALE.” Go to Exception #2 (or the next available exception). Turn its DISPLAY off. Go to the exception string and enter the words “WELCOME TO BANK OF A ” exactly as they appeared on the screen, including spaces.

OPERATOR

Although “OPERATOR” comes after “RANGE” in the sub-menu sequence, we will discuss it first because the operator determines the behavior of the range. Think of the operator in mathematical terms. Setting the correct range and specifying “IN” or “OUT” will make the operator perform “greater than”, “less than”, “equal to”, “in the range”, or “out of the range” calculations.

With the VSSI-Pro you can define ranges for your exceptions and have the VSSI-Pro alarm when an exception falls within the range’s parameters or outside the range of the two numbers. The choices are: “IN”, “OUT”, and “NONE”.

The Operator, Range and Exception String allow you to define very specific parameters for your Exception Report. The possibilities are virtually endless.

DEFINING THE OPERATOR

To make your selection, press the “Up” or “Down” button to move the cursor to “OPERATOR” and press “Set”. The cursor will start flashing. Press the “Up” or “Down” button to toggle between “ON” or “OFF”. Make your selection and press “Set”. The cursor will stop flashing and you may continue to the next menu item.

RANGE

Choices : 0000.00-0000.00

The range defines the limits of the operator. These are numeric only. The range has two separate fields that are separated by a double-sided arrow. This format must be followed.

PROGRAMMING THE VSSI-PRO

NAVIGATING THE RANGE AND THE EXCEPTION STRING

Before you define your range, we need to explain how to navigate through the range and exception string using the front panel switches. To program the range, press the “Up” or “Down” button to move the cursor to “RANGE” and press “Set”. The first “0” in the range starts to flash. This means it is active and ready for programming. Press the “Up” or “Down” button to cycle through the values and press “Set” when the desired value is displayed. This will advance the active block to the next character. While you are on an active block, pressing the “Up” and “Set” buttons simultaneously will return that block back to a blank, which is designated by a solid white box. You can follow this format to program your range. When you have finished and wish to set this range into the VSSI-Pro memory, simultaneously press and release the “Up” and “Down” buttons. You can also use this if you make a mistake and want to start over, since there is no backspace feature.

DEFINING THE RANGE

To define the range for the selected exception, press the “Up” or “Down” button to move the cursor to “RANGE” and press “Set”. This will make the first position in the range field active. Follow the procedure outlined in the previous few paragraphs to enter your range.

EXITING THE RANGE FIELD

When you are ready to exit and continue on, simultaneously press and release the “Up” and “Down” buttons. This will set the range in the VSSI-Pro memory and exit you back to the EXCEPTION REPORT sub-menu.

PROGRAMMING NOTE 

Press “Up” and “Set” together to erase an entry. Press “Up” and “Down” together to set the range or exception string into memory and to return to the previous menu.

Now every time the VSSI-Pro “sees” a line of text that includes this text string (a line is defined as text between CR), it will not display them because the exceptions display has been turned off.

EXIT

Press the “Up” or “Down” button to move the cursor to “EXIT” and press “Set” to return to the previous menu.

ALARM OUTPUTS

Press the “Up” or “Down” button to move the cursor to “ALARM OUTPUTS” and press “Set”. The following sub-menu will appear:

| | | | |
|----------------------------------|----------------|----|--------|
| <input checked="" type="radio"/> | ALARM NO. | | 1 |
| <input type="radio"/> | ALARM TRIGGER | EX | 1 |
| <input type="radio"/> | NORMAL STATE | | NO |
| <input type="radio"/> | ALARM DURATION | | 20 |
| <input type="radio"/> | FLAG TYPE | | FLASH* |
| <input type="radio"/> | FLAG DURATION | | 000 |
| <input type="radio"/> | TRIGGERED TEXT | | |
| <input type="radio"/> | EXIT | | |

Figure 41: ALARM OUTPUTS Sub-Menu

NOTE 

The VSSI-Pro provides one hard alarm output to trigger other devices such as VCR's, DVR's, QUADS, Enunciators, LED's, or other alarming devices.

The ALARM OUTPUTS menu controls not only the formatting of the external alarms, but also the formatting of the on-screen flags assigned to individual exceptions.

ALARM NO.

Choices: 1 through 16

You have the ability to tie Alarm 1 to any of the programmed exceptions to trigger an external device.

To select the alarm number that you want to program, press the "Up" or "Down" button to move the cursor to "ALARM NO." and press "Set". The cursor will start flashing. Press the "Up" or "Down" button to toggle through the values. When you have made your selection, press "Set". The cursor will stop flashing and you can continue programming your VSSI-Pro.

ALARM TRIGGER

Choices: NONE, RTS, 1-24, 13-24, 1-12, 1, 2, 3, 4, 5, 6, 7, 8, 9, 10, 11, 12, 13, 14, 15, 16, 17,18, 19, 20, 21, 22, 23,24

An alarm trigger is the source of activity programmed to activate a certain alarm. The alarm trigger tells the VSSI-Pro what exception is used to trigger the alarming device or the on-screen flag. The choices are:

Exceptions 1, 2, 3, 4, 5, 6, 7, 8, 9, 10, 11, 12, 13, 14, 15, 16, 17,18, 19, 20, 21, 22, 23, 24

(alarms when data is received that matches what you have set in these exception strings).

Exceptions 1-12: alarms when data is received that matches any data set in Exception 1-12.

Exceptions 13-24: alarms when data is received that matches any data set in Exception 13-24.

Exceptions 1-24: alarms when data is received that matches any data set in Exception 1-24 or All

RTS

External alarm input. The VSSI-Pro has 1 alarm input. A contact closure to ground on this input (pin 5 is ground) will trigger this alarm. Coupled with the RTS-triggered text, you can now display a 40 character message from an external alarm input.

None: *Sends no alarming data.*

NOTE 

In order for you to program an exception to trigger the external alarm number 1 or 2, you must add wires to the DB-9 connector on the VSSI-Pro. The alarm output employs an open collector transistor to activate the external alarms.

PROGRAMMING THE VSSI-PRO

Pin 1 on the DB-9 is Alarm 1 and Pin 5 is ground. To select the alarm trigger that you want to program, press the “Up” or “Down” button to move the cursor to “ALM TRG” and press “Set”. The cursor will start flashing. Press the “Up” or “Down” button to cycle through the values and press “Set” when the desired value is displayed.

NORMAL STATE

Choices: NO, NC

There are two choices: NO (Normally Open) or NC (Normal Closed). These selections determine whether the alarm outputs will act as a normally open switch or a normally closed switch. To select the normal state that you want to program, press the “Up” or “Down” button to move the cursor to “NORMAL STATE” and press “Set”. The cursor will start flashing. Press the “Up” or “Down” button to cycle through the values and press “Set” when the desired value is displayed.

ALARM DURATION

Choices: PULSE, 1, 3, 5, 10, 15, 20, 30, 60, 120, 180, 240 seconds.

This is the amount of time in seconds that the alarm will remain activated once it is triggered. PULSE sends a 200mS alarm pulse to the alarm device. To select the amount of time in seconds that you want to program the alarm duration, press the “Up” or “Down” button to move the cursor to “ALARM DURATION” and press “Set”. The cursor will start flashing. Press the “Up” or “Down” button to cycle through the values and press “Set” when the desired value is displayed.

FLAG TYPE

Choices: NONE, FLASH, REVERSE, FLASH, **

This feature allows you to insert a visual alarm flag on each exception that you program to aid in the review of the video tape. This flag can appear as an asterisk (“*”), a flashing asterisk, reverse text, or flashing reverse text. To make your selection, press the “Up” or “Down” button to move the cursor to “FLAG TYPE” and press “Set”. The cursor will start flashing. Press the “Up” or “Down” button to cycle through the values and press “Set” when the desired value is displayed.

FLAG DURATION

Choices: 000, 002, 004,..., 236, 238, 240

This is the amount of time in seconds that the on-screen FLAG, either the asterisk or the reverse mode, will remain activated once it is triggered.

NOTE

Flag Duration is independent of the optional Alarm Duration. Flag Duration is the amount of time the on-screen flag will remain on after activation, while Alarm Duration (available only with the option installed) is the amount of time that the hard-wired Alarm Output remains activated after it is triggered.

To select the amount of time in seconds that you want to program for the flag duration, press the “Up” or “Down” button to move the cursor to “FLG DURATION” and press “Set”. The cursor will start flashing. Press the “Up” or “Down” button to cycle through the values and press “Set” when the desired value is displayed.

TRIGGERED TEXT

Triggered Text is a data string that associates with one of the 16 alarms. When the alarm is triggered by a source, the associated string is sent out and/or displayed if enabled respectively. Each Triggered Text can contain up to 40 printable ASCII data. If non-printable data (control code) is included, each control code occupies 3 printable spaces. Therefore only 13 control codes maximum can be programmed in one Triggered Text program control escape etc.



Figure 42: TRIGGERED TEXT Sub-Menu

DISPLAY TEXT

Choices: ON, OFF

OUTPUT TEXT

Choices: ON, OFF

NOTE  *2 Exception Strings, Nos. 23 & 24, are preprogrammed for beginning and ending transactions and with DISPLAY off. The display messages for these two exceptions are “TRANSACTION BEGIN” and “TRANSACTION END,” which means that when a transaction starts, an on-screen alarm is triggered and the “TRANSACTION BEGIN” message will be sent out but not displayed, and the same will occur at the end of a transaction. You can display either of these messages by turning DISPLAY for these numbers “ON”.*

To program the Triggered Text, go to the ALARM OUTPUTS sub-menu. Select the desired ALARM NO, then go to the TRIGGERED TEXT sub-menu. The DISPLAY and OUTPUT TEXT menu entries are self explanatory. Select the third entry to program the TRIGGERED TEXT. When this entry is selected, the currently programmed Triggered Text is displayed at the lower part of the screen and the text is entered from here. To enter a control code, first put an up-arrow then put a two-digit HEX code, e.g., to put a HEX code 01H, program in 01.

SET TRIGGERED TEXT

Set Triggered Text can be used as an alarm input to trigger a corresponding programmed alarm. You can select RTS as a triggering source of any of the 16 alarms.



Figure 43: SET TRIGGERED TEXT Sub-Menu

EXIT

Press the “Up” or “Down” button to move the cursor to “EXIT” and press “Set” to return to the previous menu.

PROGRAMMING THE VSSI-PRO

TEST/DEMO MODE

The Test/Demo Mode provides you with several ways to test the VSSI-Pro and show its capabilities as an ATM interface. There is no actual programming in this menu that you need to do now or settings that you would change. You will probably only run the tests for troubleshooting purposes, and the demos would be helpful for demonstrating the VSSI-Pro to a customer without actually having to access an ATM.

To access this section, press the “Up” or “Down” button to move the cursor to “TEST/DEMO MODE” and press “Set”. The following sub-menu will appear:

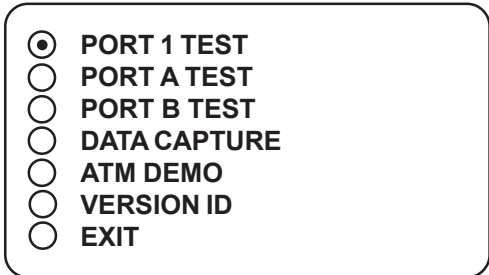



Figure 44: TEST/DEMO MODE Sub-Menu

NOTE  *The figures used in the test display settings are for example only. The settings for your ATM will depend on the format chosen in the ATM SELECT menu.*

PORT 1 TEST

Port 1 is the serial data from pins 2 & 3 of the DB-9 which send data from the VSSI-Pro to a printer. Sending and receiving data performance can be analyzed under the PORT 1 TEST sub-menu. Press the “Up” or “Down” button to move the cursor to “PORT 1 TEST” and press “Set”. The following sub-menu will appear:

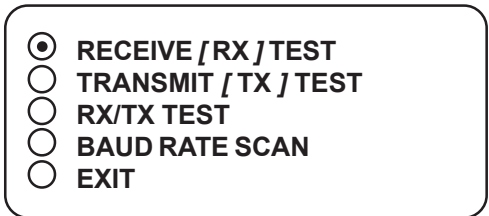

Figure 45: PORT 1 TEST Sub-Menu

RECEIVE [RX] TEST

This checks if the VSSI-Pro is receiving data from the ATM serial interface. Press the “Up” or “Down” button to move the cursor to “RECEIVE [RX] TEST” and press “Set”. The following display will appear (example only):

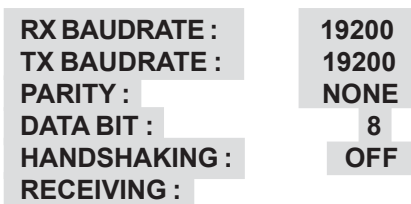

Figure 46: RECEIVE [RX] TEST Display

NOTE 

In any of these tests, you can pause the data scrolling by holding down either the "Up" or "Down" button.

The VSSI-Pro is now waiting for data from the ATM. Enter a transaction. If the VSSI-Pro is receiving data, it will appear in three separate lines, scrolling from right to left across the bottom of the on-screen display. The first line is the transaction information. The second and third lines represent the HEX equivalent of the data in the first line.

- 0 Data
- 3 HEX MS nibble
- 0 HEX LS nibble

If you perform this test and do not receive any data then check all connections to the VSSI-Pro.

TRANSMIT [TX] TEST

In the Transmit Test, the VSSI-Pro sends a predefined ASCII pattern to further test the hardware connections of the system. Press the "Up" or "Down" button to move the cursor to "TRANSMIT [TX] TEST" and press "Set". The following display will appear (example only):

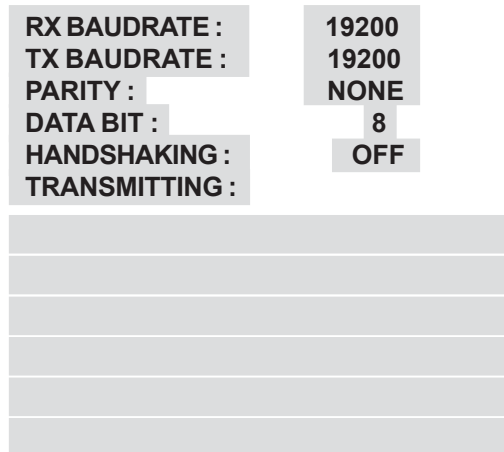

Figure 47: TRANSMIT [TX] TEST Display

Press "Set" to return to the previous menu.

RX/TX TEST

In the RX/TX Test, the VSSI-Pro echoes whatever it receives to further test the hardware connections of the system. Press the "Up" or "Down" button to move the cursor to "RX/TX TEST" and press "Set". The following display will appear (example only):

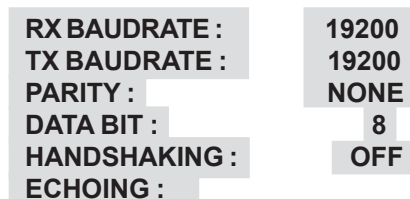

Figure 48: RX/TX TEST Display

Press "Set" to return to the previous menu.

PROGRAMMING THE VSSI-PRO

BAUD RATE SCAN

There may be times when the baud rate cannot be detected on start-up. In the Baud Rate Scan test, you can scan for the baud rate of your interface. Press the “Up” or “Down” button to move the cursor to “BAUD RATE SCAN” and press “Set”. The following display will appear (example only):

```
RX BAUDRATE : 2400
TX BAUDRATE : 19200
PARITY : NONE
DATA BIT : 8
HANDSHAKING : OFF
BAUD RATE SCAN :
```

Figure 49: BAUD RATE SCAN Display

Enter a transaction and the VSSI-Pro will scan for the baud rate and display it where “AUTO” is on the menu. Press “Set” to return to the previous menu.

EXIT

Press the “Up” or “Down” button to move the cursor to “EXIT” and press “Set” to return to the previous menu.

PORT A TEST

Press the “Up” or “Down” button to move the cursor to “PORT A TEST” and press “Set”. The following sub-menu will appear:

```
⊙ RECEIVE [RX] TEST
○ TRANSMIT [TX] TEST
○ RX/TX TEST
○ EXIT
```

Figure 50: PORT A TEST Sub-Menu

Both Ports A & B examine data from the ATM Interface. For troubleshooting purposes you may at some point need to do a data dump. Use this sub-menu to instigate the procedure, but first you have to make the proper connections and run preliminary tests before the data dump can occur. For now we will provide a brief overview of these menus. For information on a data dump procedure see Appendix A.

RECEIVE [RX] TEST

Press the “Up” or “Down” button to move the cursor to “RECEIVE [RX] TEST” and press “Set” to access statistics on the following items (example only):

```
PROTOCOL : ASYNC
RX BAUDRATE : 19200
TX BAUDRATE : 19200
DATA ENCODE : NRZ
RECEIVING : ASCII
```

Figure 51: RECEIVE [RX] TEST Display

Here are the current communication settings for your ATM and under RECEIVING will scroll the data being received from the ATM. Press “Set” to return to the previous menu.

TRANSMIT [TX] TEST

Press the “Up” or “Down” button to move the cursor to “TRANSMIT [TX] TEST” and press “Set”. The following display will appear (example only):

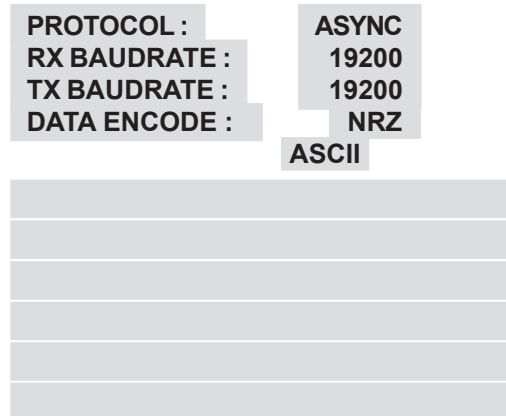

Figure 52: TRANSMIT [TX] TEST Display

Press “Set” to return to the previous menu.

EXIT

Press the “Up” or “Down” button to move the cursor to “EXIT” and press “Set” to return to the previous menu.

PORT B TEST

The sub-menu items for Port B are the same as for Port A. The only difference is that Port A is the data from the modem to the ATM and Port B is the data from the ATM to the modem. Note that the RX/TX TEST for Port B is not functional at this time.

DATA CAPTURE

Press the “Up” or “Down” button to move the cursor to “DATA CAPTURE” and press “Set”. The following sub-menu will appear:

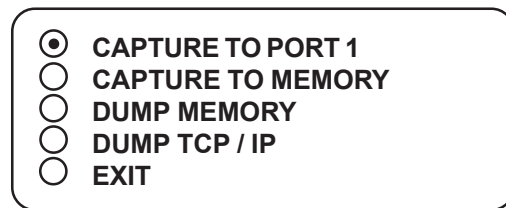

Figure 53: DATA CAPTURE Sub-Menu

CAPTURE TO PORT 1

Press the “Up” or “Down” button to move the cursor to “CAPTURE TO PORT 1” and press “Set”. The following display will appear (example only):

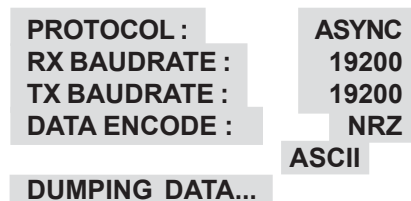

Figure 54: CAPTURE TO PORT 1 Display

Press “Set” to return to the previous menu.

PROGRAMMING THE VSSI-PRO

CAPTURE TO MEMORY

Press the “Up” or “Down” button to move the cursor to “CAPTURE TO MEMORY” and press “Set”. The following display will appear (example only):

```
PROTOCOL :          ASYNC
RX BAUDRATE :       19200
TX BAUDRATE :       19200
DATA ENCODE :       NRZ
                   ASCII
CAPTURE DATA TO MEMORY
CHA RX BYTE :       00000
CHB RX BYTE :       00000
```

Figure 55: CAPTURE TO MEMORY Display

Press “Set” to return to the previous menu.

DUMP TCP/IP

Press the “Up” or “Down” button to move the cursor to “DUMP TCP/IP” and press “Set”. The following sub-menu will appear:

```
⦿ IP ADDRESS 1      0
○ IP ADDRESS 2      0
○ IP ADDRESS 3      0
○ IP ADDRESS 4      0
○ EXIT
```

Figure 56: DUMP TCP/IP Sub-Menu

An asterick shows which of IP Addresses 1-4 is selected. Press the “Up” or “Down” button to move the cursor to the desired IP Address 1-4 and press “Set”. The cursor will start flashing. Press the “Up” or “Down” button to set the value. The choices are 0 through 255. When the desired value is displayed press “Set”. Press the “Up” or “Down” button to move the cursor to “EXIT” and press “Set”. You will be presented with the following display (example only):

```
PROTOCOL :          ASYNC
RX BAUDRATE :       19200
PARITY :            NONE
DATA BIT :          8

BUFFER REMAINING :  03071
RECEIVED BYPE :    0000
```

Figure 57: DUMP TCP/IP Display

Press “Set” to return to the previous menu.

ATM DEMO

This demonstrates the VSSI Pro's use as an Automatic Teller Machine Interface. To access this demonstration, press the “Up” or “Down” button to move the cursor to “ATM DEMO” and press “Set”. The demo will start after a few seconds. To exit this demo, press “RESET”. This will take you out of the programming menu entirely though, and you will have to re-enter the main-menu to continue programming.

TRANSACTION BEGIN

```
TRANS 5697
05 / 26 / 05 12:32 059
0026
TST ATM RALEIGH
3100 HIGHWOODS BLVD
RALEIGH # 2 NC
05 / 19 / 05 BUSINESS DATE
CODE*SERIAL AMOUNT
5697 10.00
WITHDRAWAL
FROM CHECKING
CHK BAL $21.601.42
TRANSACTION END
```

Figure 58: ATM DEMO Display

VERSION IDENTIFICATION

When selected, this will display the current VSSI-Pro version and revision number.

```
VSSI PRO V13.28R9
05 / 26 / 2005
```

Figure 59: Version / Revision Identification Display

LOGO

This demo displays the AVE logo cycling through several sizes. To access this demonstration, place the arrow in front of LOGO and press and release “Set”. The demo will start, but again, you will have to reenter the main menu if you want to continue viewing your programming options.

DOWNLOAD/UPLOAD SETUP

This feature lets you upload or download data between two VSSI Pro’s or a VSSI-Pro and a PC. This feature is especially helpful on multi-interface installations. You can program one VSSI-Pro and download the data to another VSSI-Pro with the download/upload feature and a data transfer cable. The cable is made up of two male DB-9 connectors and the pin-out is below.

```
DOWNLOAD/UPLOAD DATA CABLE

PIN 2 _ _ _ _ PIN 3
PIN 3 _ _ _ _ PIN 2
PIN 5 _ _ _ _ PIN 5
```

Figure 60: Pin-Out for Download/Upload Data Cable

PROGRAMMING THE VSSI-PRO

DOWNLOAD/UPLOAD SETUP USING VSSI-PRO TO VSSI-PRO

To insure that the DOWNLOAD/UPLOAD process is accomplished, you need to access the programming menus for both VSSI-Pro's, so each VSSI-Pro needs a video input and a monitor. The optimum way to perform the DOWNLOAD/UPLOAD process would be to have a system set up with two separate cameras and monitors and the programmed VSSI-Pro with the download data cable attached. This would allow you to program one VSSI-Pro on site and bring the programmed VSSI-Pro back to the office and program additional VSSI-Pro's quickly. We realize this may not always be possible to do and that there may be a need for field programming. The only difficulty with the field DOWNLOAD/UPLOAD process is accessing the programming menus of both VSSI-Pro's simultaneously.

The use the following diagram will let you perform the DOWNLOAD/UPLOAD process in the field. For this, you will need a short BNC to BNC cable approximately a foot long, the data cable, and a monitor that can be used next to the VSSI-Pro's.

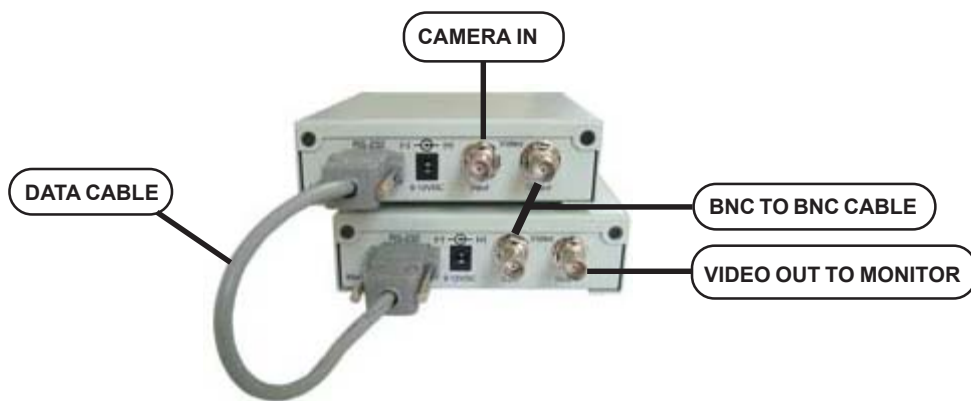

Figure 61: DOWNLOAD/UPLOAD SETUP Using VSSI-Pro to VSSI-Pro

The PROGRAMMED VSSI-Pro will upload data to the UNPROGRAMMED VSSI-Pro. In the configuration above, you can get the programming menus for both VSSI-Pro's on the screen at the same time. Use the front panel shortcut to position the text block from the PROGRAMMED VSSI-Pro on the left side of the screen. To do this, press and hold down the "Up" button, then press and release the "Reset" button and then release the "Up" button. Now by using the "Up" and "Down" buttons you can move the display side to side on the screen. Move the text block as far to the left as you can and press "Set" to exit. To move the display to the top of the screen, press and hold down the "Set" button and press and release the "Reset" button, then release the "Set" button. Now by using the "Up" and "Down" buttons you can move the display up and down on the screen. Move the display to the top of the screen. When you have it in the correct position, press "Set" to exit.

Go to the UNPROGRAMMED VSSI-Pro and follow the same instructions to move the display to the right side of the screen. After you have both displays positioned properly, the next step is to bring up both programming menus.

Let's bring up the PROGRAMMED VSSI-Pro first. To do this, simultaneously press and hold the "Up" and "Down" buttons and press and release the "Reset" button, then release the "Up" and "Down" buttons. This will bring up the main-menu and it should be on the top left of the screen. Now go to the UNPROGRAMMED VSSI-Pro and do the same thing. You should now have both programming menus side by side.

NOTE 

Depending on the size of the monitor you are using, these two menus may overlap, but it should not be a problem.

NOTE 
The Download/Upload feature can only be used on VSSI-Pro's with the same software revision level.

To proceed with the DOWNLOAD/UPLOAD SETUP, we will configure the UNPROGRAMMED VSSI-Pro first. From the main-menu, press "Up" or "Down" to move the cursor to "DOWNLOAD/UPLOAD SETUP" on the menu on the right side of the screen. Press "Set". The following sub-menu will appear:



Figure 62: DOWNLOAD/UPLOAD SETUP Sub-Menu

Press the "Up" or "Down" button to move the cursor to "DOWNLOAD SETUP" and press "Set". The following sub-menu will appear. Move to the cursor to "DOWNLOAD SETUP" and press "Set" and the display "DOWNLOAD SETUP..." will appear:

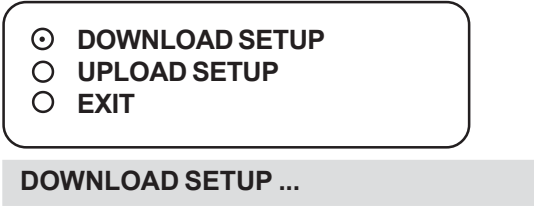

Figure 63: DOWNLOAD SETUP Sub-Menu & Display

The UNPROGRAMMED VSI-Pro is now waiting to receive data from the PROGRAMMED VSI-Pro.

Now go to the main-menu of the PROGRAMMED VSI-Pro and follow the previous instructions to get to "UPLOAD SETUP" and press "Set". The following sub-menu will appear. Move to the cursor to "UPLOAD SETUP" and press "Set" and the display "UPLOAD SETUP..." will appear:

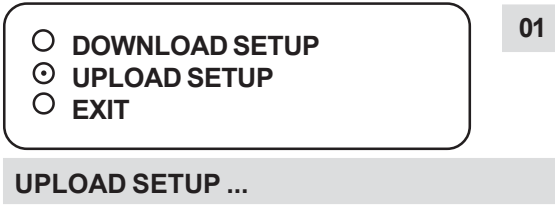
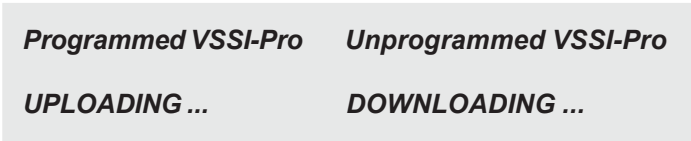

Figure 64: UPLOAD SETUP Sub-Menu & Display

The data transfer will begin and you will have a screen count down of the status that reads:



PROGRAMMING THE VSSI-PRO

The count will end at 100. When this prompt clears the screen, the data transfer is complete. Press "Reset" to exit this menu on both VSSI-Pro's.

Now go to the main-menu of the previously UNPROGRAMMED VSSI-Pro on the right side of the screen. Enter the EXCEPTIONS menu. You should see your exceptions and other programmed data just as they were on the original PROGRAMMED VSSI-Pro.

DOWNLOAD/UPLOAD SETUP USING A PC

You can use a Laptop PC and AVE's IC or equivalent communications program to store data from a VSSI-Pro to a file. This file can then be uploaded to other VSSI-Pro units with the same software revision level. Use 4800 baud for the PC's baud rate.

| VSSI-Pro | DB-9 (Serial Port) | DB-25 (Parallel Port) |
|----------|-----------------------|--------------------------|
| 2 | 3 | 2 |
| 3 | 2 | 3 |
| 5 | 5 | 7 |

Table 4: Triport Pin-Out

NOTE 

For locations or companies with a large number of interfaces, we strongly advise that you keep one programmed VSSI-Pro as a master and a backup to insure your system integrity. This will also aid in reprogramming any changes and protect against any catastrophic events.

HELP

A helpful reference of key terms used in programming your VSSI-Pro.

| | |
|--------------------------|----------------------|
| Key Definitions : | |
| UP/DOWN | -- Change value |
| SET | -- Enter change mode |
| | save change |
| | Go to Position |
| UP AND DOWN | -- Save string input |
| UP AND SET | -- Erase character |

Figure 65: HELP Sub-Menu

DATA DUMP CONNECTIONS

To execute a data dump you will have to connect wires from the DB-9 connector of the VSSI-Pro to either Com 1 or Com 2 of a computer, using the following pin-out diagram:

| SDLC / BISYNC | CAMERA PORT / JOURNAL / TCPIP | Com 1 (DB-9) | Com 2 (DB-25) |
|---------------|-------------------------------|--------------|---------------|
| 3 | 8 | 2 | 3 |
| 5 | 5 | 5 | 7 |

Table 1A: Data Dump Connections

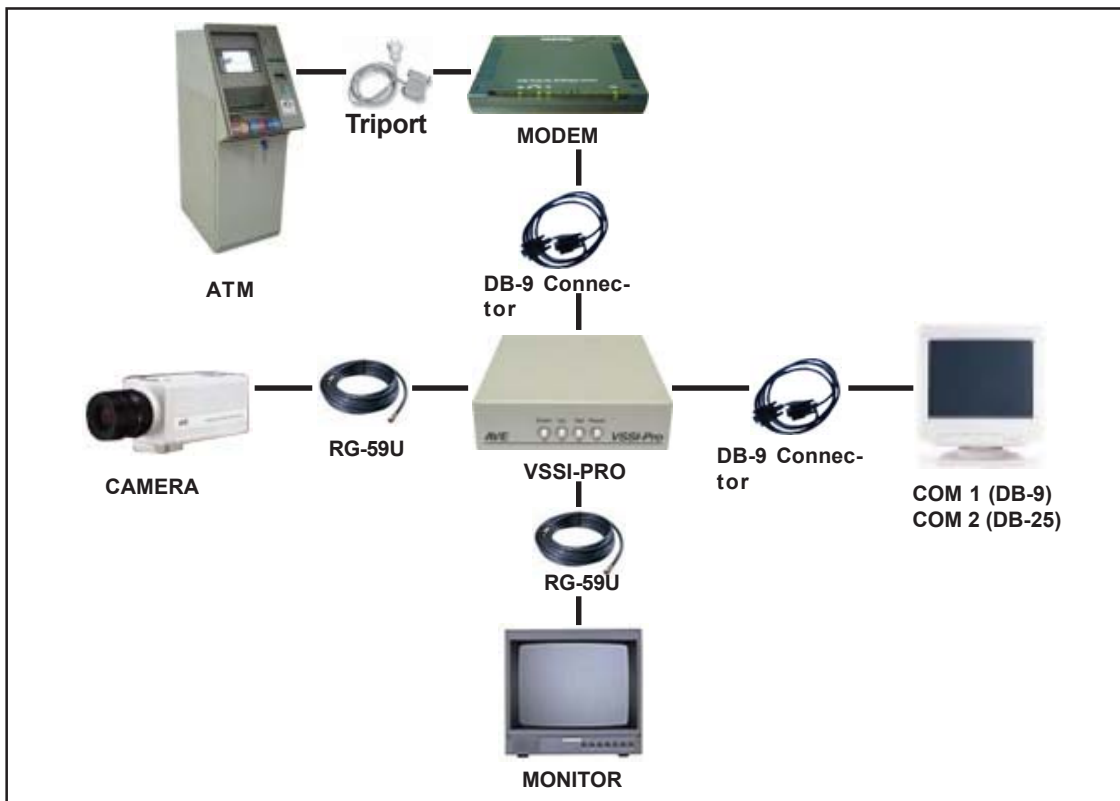

Figure 1A: Data Dump Connections

PERFORMING A DATA DUMP

1. Make the proper connections as shown.
2. Make sure the PORT 1 communication settings are the same as the computer’s settings.
3. Run a PORT A receiving test (access PORT A submenu in TEST/DEMO of the main programming menu) to make sure data is being received.
4. Go to DUMP DATA in the PORT A submenu and press “Set”. The data should appear on the computer screen. Save this data to a file.

Follow the same procedure for performing a data dump from PORT B using the PORT B sub-menu for a receiving test and the DUMP DATA command.

PROBLEM SOLVING GUIDE

This section contains a Problem Solving Guide and additional information regarding AVE's interfaces, cables, tips, and special applications.

NOTE 

Before attempting to install your system, we highly encourage you to get your customer to demonstrate to you that their ATM is operating properly.

No data on screen:

1. Press the reset button on the front panel.
2. Incorrect protocol selected in the ATM SELECT Menu.
3. Data cable is miswired.
4. Data cable is too long or did not use shielded cable.

No video on monitor:

1. VSSI-Pro transformer not plugged in.
2. Video In / Out connectors reversed.
3. No video input signal.
4. Bad video cable or connector.
5. Camera Iris is closed.

Characters Jitter, Jump or Skew The VSSI-Pro requires 1V p-p +/- 20 percent, terminated @ 75 ohms:

1. Darken the gray scale of the characters.
2. Video Input level less than 1VP-P - use an amplifier to get the proper level.
3. Poor input sync signals - too many AC coupled amplifiers in the video input signal.
4. Noisy or poor quality video source- Replace with better source.
5. Check for double termination

Funny characters or garbage on screen:

1. Power disconnected for too long and memory is lost.
2. Lightning strike, power line noise or power surge.

SET-UP dots scroll but the COMPLETED message never appears:

1. Check ATM SELECT for protocol. Try another format.

SET-UP dots do not scroll:

1. Check ATM SELECT for protocol.
2. Check cabling.

No SET-UP Mode:

1. Choose format in ATM SELECT (Main-Menu)
2. Press Reset.

No Video:

1. Check Power Connections.

MASTER RESET THE VSSI-PRO

Simultaneously press and hold down the “Down”, “Up” and “Set” buttons. While holding these three buttons down, press and release the “Reset” button and then release the other three. Our copyright notice will appear and then disappear and the message “SET UP” will appear. Go into the ATM SELECT menu and chose your format. Then have someone perform a transaction on the ATM.

CAUTION!

Performing a master reset will set the VSSI-Pro back to its factory defaults and erase all programming including Exceptions. If you have programmed exceptions, we suggest you go to the Exception Report page and write down the exceptions.

FREQUENTLY ASKED QUESTIONS REGARDING ATM INTERFACING**My customer is changing ATMs; will the VSSI-Pro they have work on the new ATM?**

This is a tricky one. There may be other versions of software needed to work with different ATM formats. The probability the VSSI-Pro will work with a new system is relatively high, especially if it's Version 11 based.

Call AVE's Product Support Specialists for additional help along these lines.

I installed a VSSI-Pro and the On-screen text jumps or jitters.

Our VSSI-Pro text inserter requires the input video signal to be 1V P-P +/-20%, terminated @ 75 ohms. If this voltage varies either too high or too low, the VSSI has trouble synchronizing the text to the video.

There are a couple of things you can try to help settle the text down. Change the gray scale level of the text block from the whitest level to one of the slightly lower gray levels. Changing the size of the text block may help. Sometimes moving the text block away from the edge of the screen may help settle the text down too.

If these don't seem to have an effect then try using a distribution amp like AVE's VDA-601 to properly adjust the video level. If the camera you're using has an auto iris lens, try adjusting the iris to average and then reduce or increase the level.

RS-485 NETWORKER

The RS-485 Networker is designed to convert the RS-232 serial port output of the VSSI-Pro to be a poll/select network. This allows all the transaction data to be collected by one computer for up to 64 VSSI-Pro's.

APPLICATION

Many users of the VSSI-Pro want to capture all the transaction data from several units to one device. The RS-485 Networker allows all data from up to 64 VSSI-Pro's to be recorded on one PC or sent to one DVR. The user can then later search data history for evaluation. With remote software like PC Anywhere, a remote location could dial into many sites and review exception history and provide a value added service their existing customers.

THEORY

The VSSI-Pro contains an internal data buffer of 24K bytes. The VSSI-Pro can also be programmed for this buffer to hold all the on-screen data or just exceptions optionally containing Time/Date and other trigger text. The "handshaking" option in the VSSI-Pro allows for external hardware handshaking for this output port to be controlled by the "RTS" input. When this hardware handshaking input is false, the data is saved to the internal buffer. When this input is true the data is sent out the serial port. The RS-485 Networker controls this handshaking signal to the VSSI-Pro and when the networker is addressed by the host the data from the VSSI-Pro is sent to the host. The data from each RS-485 Networker is saved to a log file on the PC which can be read later as a data history from each VSSI-Pro.

RS-485 NETWORK

Up to 64 RS-485 Networkers can be connected on one RS-485 two-wire network. A unique address for each networker is set by its internal dipswitch. The protocol is basically poll/select. The baud rate is set at 19.2K.

RS-232 to RS-485 CONVERTER

A standard PC or laptop is used with the supplied software. The RS-232 to RS-485 Converter converts the PC or DVR RS-232 to RS-485. The handshaking signals of the PC control the direction of the RS-485 communications.

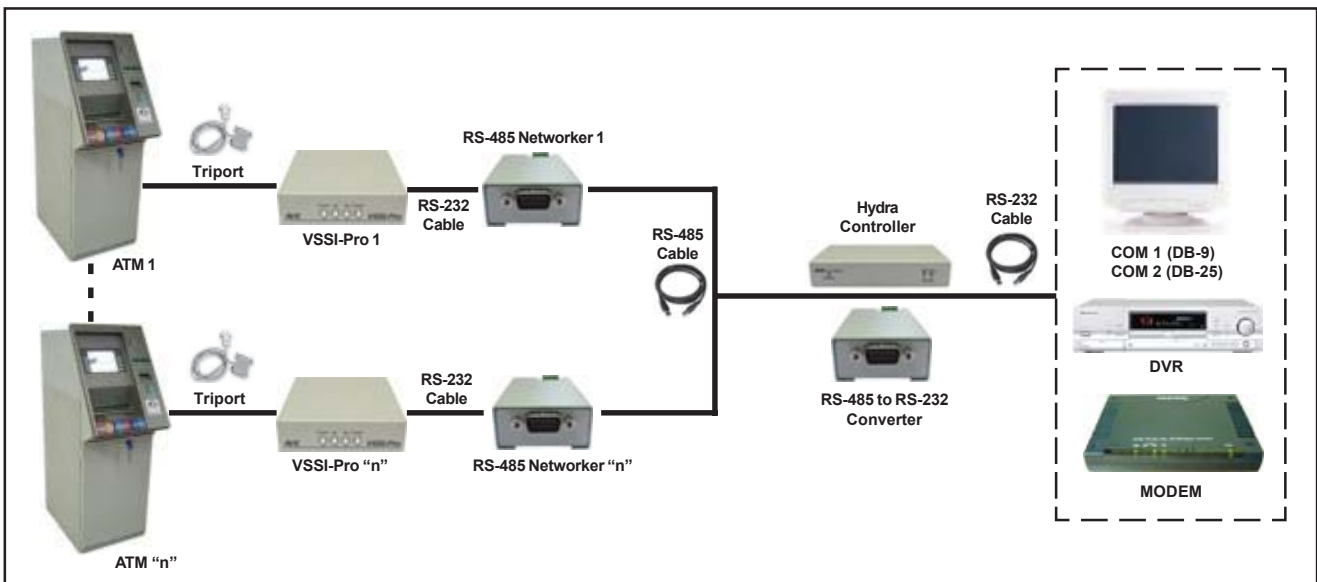

"n" means up to 64 Cash Registers / VSSI-Pro's / RS-485 Networkers can be connected on one RS-485 Network

Figure 1E: Connection Diagram for RS-485 Network

The simple to install and use PC Software allows up to 64 VSSI-Pro ATM Interfaces to be configured on an RS-485 network and report all the transaction data back to a single monitoring computer. This Windows based software can be configured to display in a windowing horizontal format below or tiling in a vertical format. All data file are stored separately as independent files on the PC and can be downloaded or searched locally or remotely to find specific transaction data or information. This can be used in conjunction with Windows based DVRs or ATMs software and eliminate the use of an additional PC for the collection, search or transmission.

WINDOWS TILE HORIZONTAL

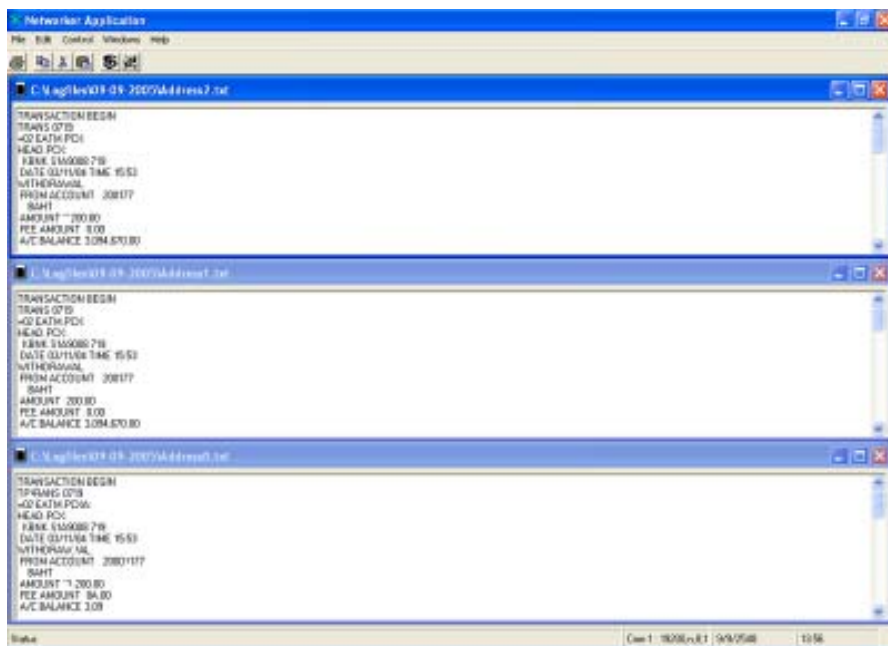

Figure 1F: Window Tile Horizontal

HARD ALARM OUTPUT

The Alarm Output provides one open collector transistor alarm output to trigger alarming devices. Upon an Exception, a VSSI-Pro can be programmed to trigger a VCR to go to its fastest record time, have a Quad go full screen, home a switcher, trigger a preprogrammed PTZ, or provide visual or audible alarms.

Following are some basic circuit designs to take advantage of the Alarm Output.

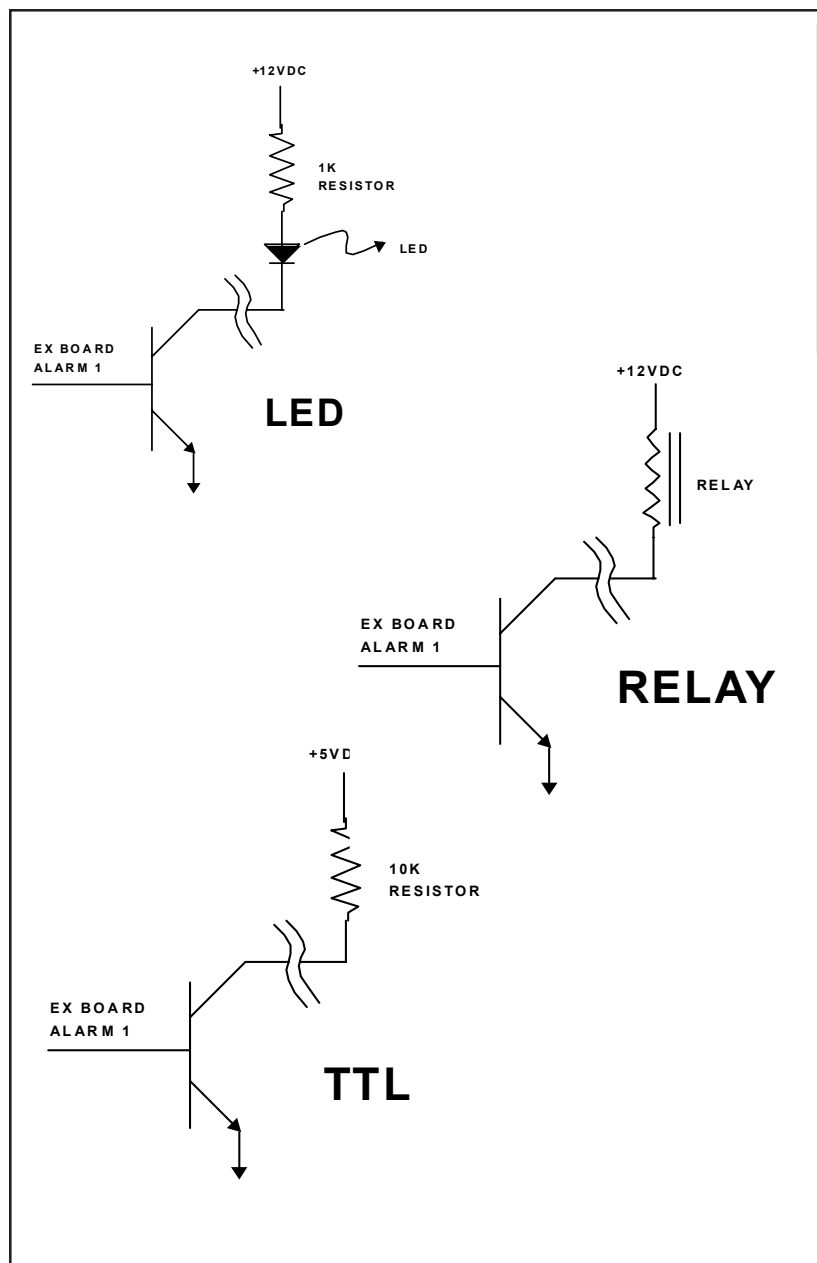

Figure 1G: Hard Alarm Output

Triport and Adapter Cable

Triports are typically used to passively tap data from a serial device. A Triport has three connectors, either 2DB-25's back to back or 2DB-9's and an additional DB-9 male which connects to the VSSI-Pro. The Triport (and cable) supplied with the VSSI-Pro is the ATM 2 Channel Triport. The following pin-out diagram for the cable is available for troubleshooting purposes.

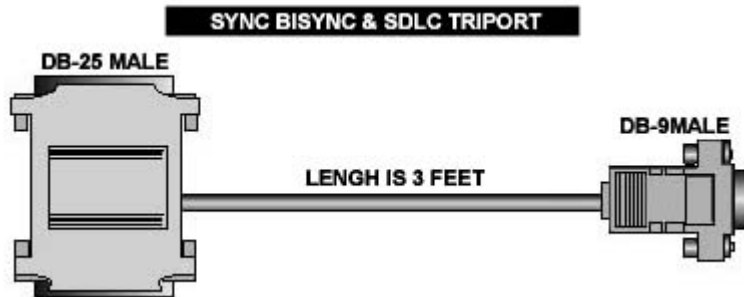

Figure 1H: The VSSI-Pro ATM 2 CHANNEL

| DB-25 FEMALE | DB-9 MALE |
|--------------|-----------|
| 2 | 2 |
| 17 | 4 |
| 7 | 5 |
| 3 | 6 |
| 15 | 7 |

Table 1H: VSSI-Pro ATM 2 CHANNEL

For ATM Camera Port Connection ATM VSSI-Pro (Cable between ATM Camera Interface and VSSI-Pro)

| Camera Interface DB-25(M) | DB-9 (M) |
|---------------------------|----------|
| 2 | 3 |
| 3 | 6 |
| 7 | 5 |

Table 2H: ATM Camera Port Connection

| DB-9 (MALE) | DB-9 (MALE) |
|-------------|-------------|
| 2 | 3 |
| 3 | 6 |
| 7 | 5 |

Table 3H: TCP/IP Cable

With Data-Out Options:

| VSSI-Pro DB-9 (M) | DB-9 (M or F) |
|-------------------|---------------|
| 8 | 2 |
| 5 | 5 |

Table 4H: Data Output Option

With RTS Triggered Text:

| VSSI -Pro | DB-9 (M) |
|-----------|---------------------|
| 9 | Trigger Input (+) |
| 5 | Trigger Input (GND) |

Table 5H: RTS Triggered Text

NOTE

The VSSI-Pro does not provide any hardware handshaking signal. The ATM camera port must either be programmed without handshaking or the handshaking signal should be looped back to the camera port.

PIN ASSIGNMENT FOR TIME SEARCH FUNCTION



Figure 1I: Pin Assignment for Time Search Function

TCPIP 232 ADAPTER CONNECTION PIN-OUT

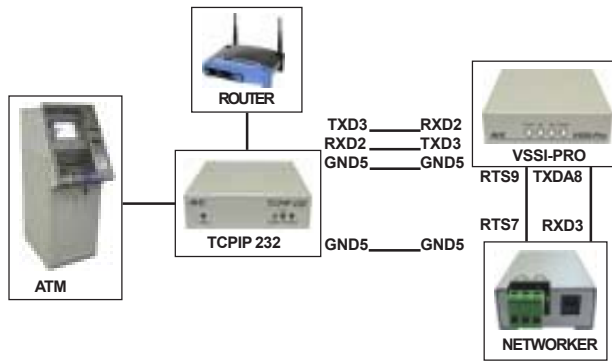

Figure 2I: TCPIP 232 Adapter Connection Pin-Out

SDLC / BISYNC / ASYNC ATM CONNECTION PIN-OUT

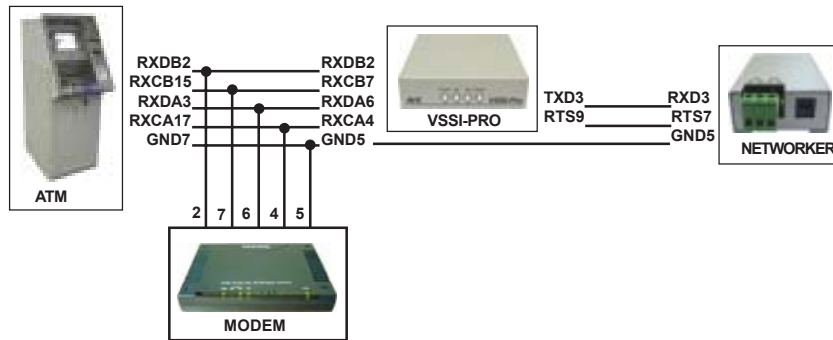

Figure 3I: SDLC / BISYNC / ASYNC ATM Connection Pin-Out

CAMERA CONTROLLER CONNECTION PIN-OUT

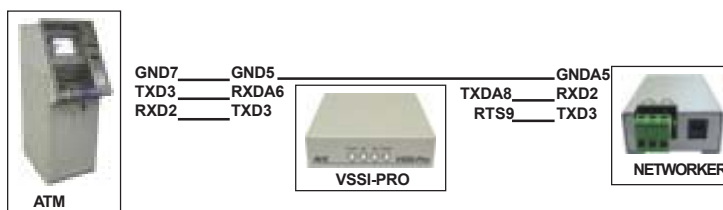

Figure 4I: Camera Controller Connection Pin-Out

LIMITED WARRANTY***(Terms and Conditions)***

For **2 Years** from the date of shipment, Seller warrants to Buyer that the Product is free from defects in material or workmanship **under normal use and service**. Equipment manufactured by other than Seller but furnished by Seller carries the same warranty to Buyer as Seller receives from the other manufacturer, notwithstanding any provision to the contrary. If Buyer has specified a particular manufacturer's product which is not the brand standardly supplied by Seller, Buyer shall look only to the other manufacturer's warranty and Seller shall not warrant such item.

EXCLUSIONS. Seller's warranty does not cover the following:

1. In-transit damage claims, improper handling by carrier or post office.

(only the consignee of the shipment can file a claim with the common carrier)

2. Damages caused by incorrect use, modification, carelessness, improper storage, hostile operating conditions, or unauthorized service, installation or repairs without proper training from the Seller
3. Damages caused by fire, flood, lightning, collision, acts of God or other events beyond the control of Seller
4. Products or parts thereof that have had serial numbers removed, altered or defaced
5. Products returned without an RMA number and sales or delivery receipt showing the date of original purchase
6. Use of components that do not meet Seller's specifications
7. External parts such as cabinets or keypads
8. Periodic maintenance and adjustments resulting from normal use

WARRANTIES EXCLUDED, SELLER EXPRESSLY DISCLAIMS AND EXCLUDES ANY EXPRESS OR IMPLIED WARRANTY OR MERCHANTABILITY OR FITNESS FOR A PARTICULAR PURPOSE WHICH EXCEEDS OR IS INCONSISTENT WITH THE WARRANTY HEREIN EXPRESSLY SET FORTH.

NON-WARRANTY CLAIMS.

In the event Buyer makes a warranty claim and Seller's warranty does not apply, Buyer shall reimburse Seller for all reasonable expenses incurred by Seller in diagnosing the installation/repair problem.

BUYER'S EXCLUSIVE REMEDIES.

If the Product supplied shall fail to conform to the contract or any applicable warranty, Buyer shall immediately notify Seller of such condition and afford Seller a reasonable opportunity to inspect said Product. Seller shall, at its option, either repair or replace such nonconforming Product.

Seller shall not be responsible for labor charges for removal or installation of such equipment or material or charges for transportation, handling and shipping except as provided in Seller's written service policy. No Product shall be returned without Seller's prior written consent.

SELLER SHALL NOT BE LIABLE FOR ANY SPECIAL, DIRECT INCIDENTAL OR CONSEQUENTIAL DAMAGES OF A COMMERCIAL NATURE ARISING OUT THE USE OF OR INABILITY TO USE SELLER'S PRODUCT BY REASON OF THE FACT THAT SUCH PRODUCT DOES NOT CONFORM TO THE CONTRACT OR TO ANY EXPRESS OR IMPLIED WARRANTY. SELLER'S MAXIMUM LIABILITY SHALL BE LIMITED TO THE COST OF REPAIR AND/OR REPLACEMENT OF THE PRODUCT CLAIMED TO BE DEFECTIVE OR NONCONFORMING, SUBJECT TO SELLER'S RIGHT OF REMOVAL AND RETURN OF PRODUCT.

All of the foregoing constitute Buyer's sole and exclusive remedy and Seller's sole and exclusive liability for supplying nonconforming or defective Product.

RETURNS

AVE products are fully inspected and carefully packed to ensure you are delivered a quality product in good condition. If you are not fully satisfied with our product, returns of standard stocking items with no restocking fee can be made within thirty (30) days of invoice to Buyer. All such returns must have prior consent of Seller by obtaining an RMA number and must include the sales or delivery receipt showing the date of original purchase and be in an unused condition contained in its original packaging. Any other returns must have prior written consent of Seller and are subject to a restocking fee of fifteen percent (15%) and freight charges.

RMA NUMBER

The RMA (Return Material Authorization) number must be obtained by contacting Seller prior to the shipment of the product for return. The RMA number is valid only for 15 days from the date of issue. The RMA number must be clearly displayed on all shipping labels.



AVE Multiview USA

**2000 West Governors Circle
Suite E, Houston, Texas 77092
Tel: 1-281-443-2300
Fax: 1-281-443-8915
Email: sales@aveusa.com
<http://www.americanvideoequipment.com>**

AVE Multiview UK

**Granyte House, Delamare Road
Cheshunt, Hertfordshire EN8 9SP
Tel: 440-870-770-9323
Fax: 440-870-770-9363
Email: enquiries@ave-uk.com
<http://www.multiview.net>**

AVE (Thailand) Co., Ltd.

**217/4 Crystal Garden Soi 4 (Nanatai)
Sukhumvit Road, Klongtoey, Klongtoey
Bangkok 10110 Thailand
Tel: 662-656-8231
Fax: 662-656-9554
Email: ave@avethailand.com
<http://www.ave.co.th> (Thailand)
<http://www.avethailand.com> (English)**