

Honeywell

Portable Evaporative Air Cooler

OWNER'S MANUAL

Read and save these instructions before use

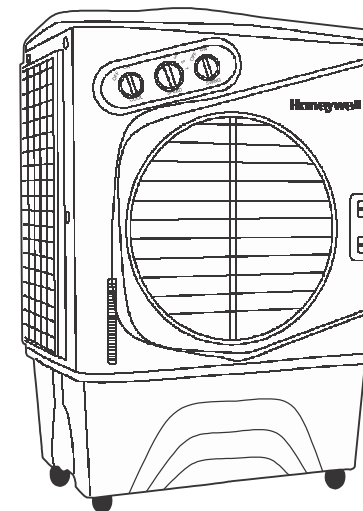

Model: CL60PM

Voltage rating: 220-240V`50Hz

Power rating: 220W

For product inquiries or support, visit www.honeywellaircoolers.com

Or call Tel +44 (0) 1477 539 500 Fax +44 (0)1477 539 530

Email sales@scott-air-cooling.co.uk

Made in P.R.C.

This page is intentionally left blank

INDEX

Read all instructions carefully before setting up and operating the unit, and please keep this instruction manual for future reference. This manual is designed to provide you with important information needed to setup, operate, maintain and troubleshoot your cooler. Failure to follow these instructions may damage and/or impair its operation and void the warranty.

| SECTION | PAGE |
|--|------|
| 1. THANK YOU | 2 |
| 2. USER TIPS | 3 |
| 3. SAFETY RULES | 5 |
| 4. PARTS DESCRIPTION | 7 |
| 5. USE & OPERATION | 8 |
| Installing Hose Adapter and Float Valve / Fill Water | 8 |
| Control Knobs | 9 |
| 6. CLEANING & MAINTENANCE | 10 |
| 7. TROUBLESHOOTING GUIDE | 12 |
| 8. TECHNICAL SPECIFICATIONS | 14 |
| 9. ELECTRICAL WIRING DIAGRAM | 14 |
| 10. WARRANTY | 15 |

THANK YOU

THANK YOU!

Congratulations on your purchase of this versatile Honeywell Evaporative Air Cooler. For optimum cooling performance from your unit, first fill it with water.

Please read these instructions carefully.

COOL ~ EFFICIENT ~ NATURAL

Evaporative air cooling is the natural way of cooling, similar to a breeze blowing across a lake. This breeze drops the temperature and has a relaxing cooling effect.

The evaporative air cooler cools the air by means of the evaporation of water. When water evaporates into the air, the result is a mixture of air and water molecules. This chemical change requires heat which is taken from the water molecules, resulting in cooler air propelled from the unit.

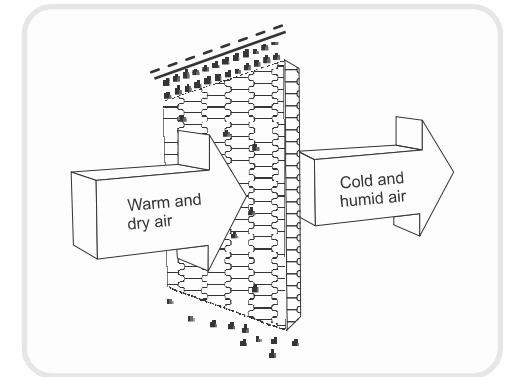
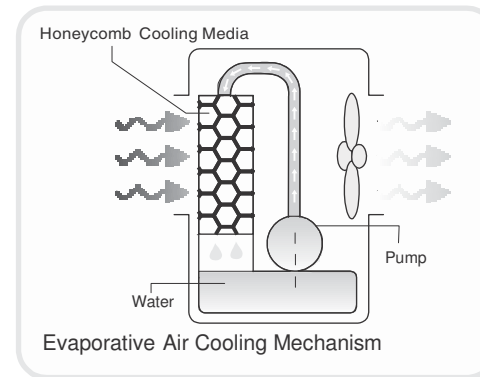

USER TIPS

The recommended maximum relative humidity level is 60% or less, which allows a noticeable temperature decrease. The temperature decrease will be greater in drier climates because higher evaporation occurs when the humidity is low.

The evaporative air cooler should not be used in enclosed spaces. It must be kept level and there must be water in the water tank. The room should have doors and windows opened to allow free air flow. The evaporative air cooler works best when placed near an open window, so that outside air is drawn into the evaporative air cooler, the air circulates in the room, and exits via the door. The maximum cooling effect is felt when a person is in the flow of air coming out of the evaporative air cooler.

The evaporative air cooler can also be used to humidify dry air during the cool weather months. To be used for humidification the windows and doors should be closed to allow the humidified air to accumulate. The evaporative air cooler is not an air conditioner as it does not use a compressor or refrigerant gas. It should not be expected to cool as to a selected, fixed temperature like a refrigerated air conditioner.

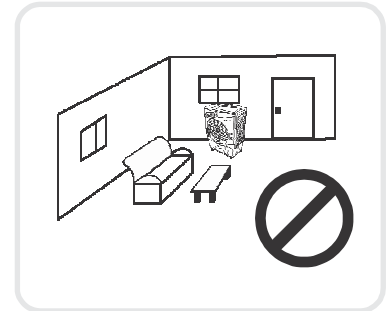
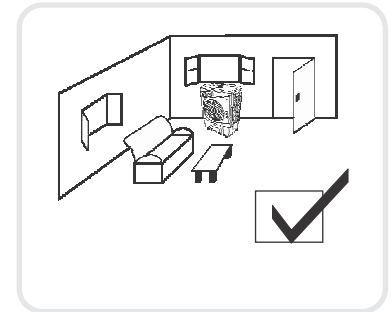

NOTE

When the product is used for the first time the Honeycomb cooling media will have an odour which will dissipate in a week or so of initial use.



SAFETY RULES

READ AND SAVE THESE INSTRUCTIONS:

When using electrical appliances, basic safety precautions should always be followed:

- Your cooler runs on 220-240 Volt AC, 50 Hz current. Check the household voltage to ensure it matches the appliance's rate specification.
- Before operating the product remove it from its packaging and check it is in good condition.
- DO NOT operate any product with a damaged cord or plug. We recommend not to use an extension cord with this appliance.
- DO NOT the run power cord under carpeting, or cover it with rugs or runners. Arrange the cord away from areas where it may be tripped over.
- Always unplug the product before refilling the water tank.
- Always unplug the appliance from the power source before cleaning, servicing or relocating the unit.
- Remove the power cord from the electrical receptacle by grasping and pulling on the power cord plug-end only, never pull the cord.
- DO NOT use the product in areas where gasoline, paint or other flammable goods and objects are stored.
- **When using the "Cool" setting, please check the water tank to ensure it is full. Operation of this unit on the "Cool" setting with an empty tank may result in damage to the water pump.**



220 -240Volt AC
50 Hz

SHOCK HAZARD



WATER LEVEL INDICATOR

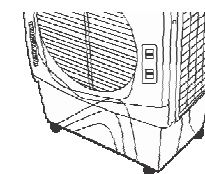

SAFETY RULES

- DO NOT attempt repair or adjust any electrical or mechanical functions of the cooler, as this may void the warranty.
- DO NOT cover the air inlet or outlet on the appliance as this may cause motor damage.
- DO NOT insert or allow objects to enter any ventilation or exhaust opening as this may damage the product and could cause an electrical shock or fire.
- DO NOT operate with the Honeycomb media removed as this will overload and damage the motor.
- DO NOT leave the appliance operating unattended for any extended period of time.
- DO NOT let children play with this appliance, packaging or plastic bags.
- If the unit is damaged or it malfunctions, do not continue to operate it. Refer to the troubleshooting section and /or please seek professional advice.
- Place the unit on a level floor.
- This product is not intended for use in wet or damp locations.
- Never locate the product where it may fall into a bathtub or other water container. DO NOT use in bathrooms.
- When it is not in use always store in a dry area.
- This appliance is not intended for use by persons (including children or elderly) with reduced physical, sensory or mental capabilities, or lack of experience and knowledge, unless they have been given supervision or instruction concerning use of the appliance by a person responsible for their safety.
- Always grip the side handles to move the unit.

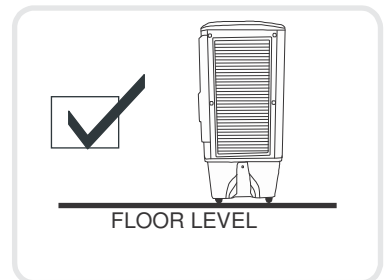
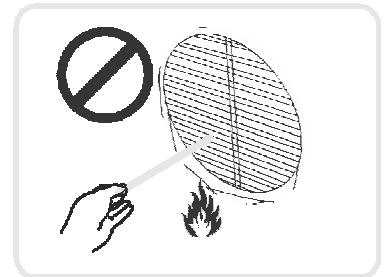
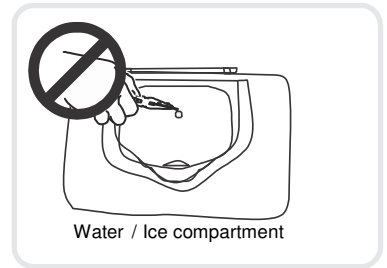

PARTS DESCRIPTION

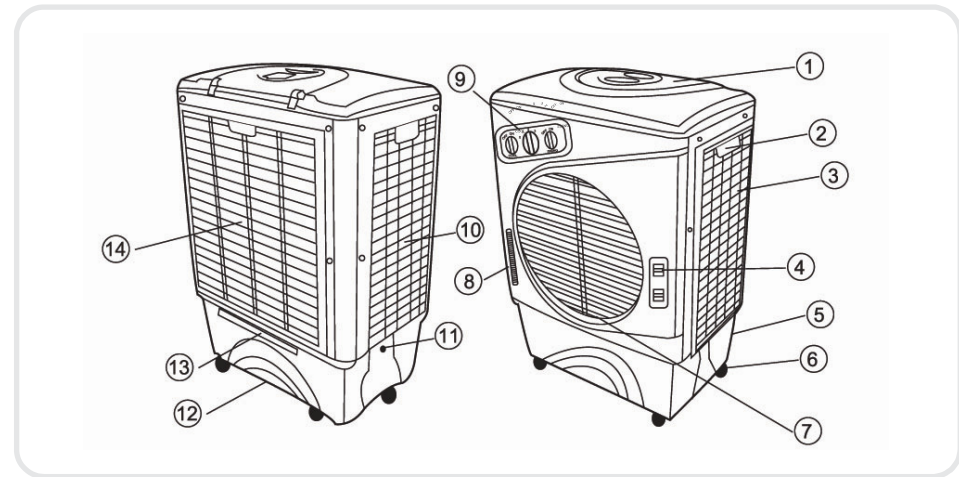

- | | |
|--------------------------------|---------------------------|
| 1 Water Inlet | 8 Water Level Indicator |
| 2 Handle | 9 Control Panel |
| 3 Right Panel | 10 Left Panel |
| 4 Lever for Horizontal Louvres | 11 Continuous Water Inlet |
| 5 Water Tank | 12 Drain Plug |
| 6 Castors | 13 Manual Water Inlet |
| 7 Horizontal Louvres | 14 Back Panel |

CONTROL PANEL

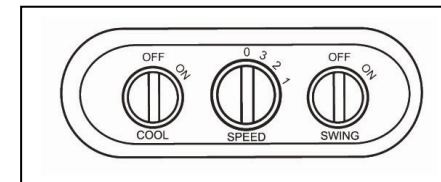

USE & OPERATION

INSTALLING HOSE ADAPTER AND FLOAT VALVE

- Connect the garden hose Connector and turn on the water.
- Verify water tight connections by visually examining both the float/hose connections.

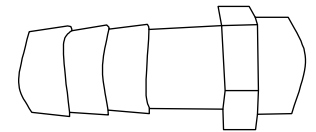

Hose Connector

FILLING WATER

Water can be filled into the air cooler by

Continuous water supply

Connect a garden hose to the continuous water supply inlet.

Manual operation

Water can be poured into the unit from the back.

Water compartment

Water can be put into the tank through the top opening.

There is a hole for water to flow into the tank.

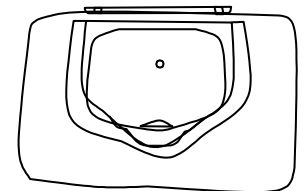

Water compartment

CONTROL KNOBS

SPEED / ON - OFF

Connect to the power supply and turn the Speed knob. The fan will start. Change the speed from 1 for Low to 2 for Medium to 3 High. To switch OFF the unit turn the Speed knob to "0".

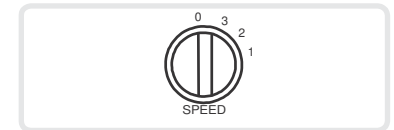

COOL

Turn the Cool knob to ON to start the cooling. It takes a few minutes to obtain the full effect from this mode.



SWING

Vertical Louvres

Turn the SWING knob to 'ON'. The louvres will begin to move from right to left automatically.

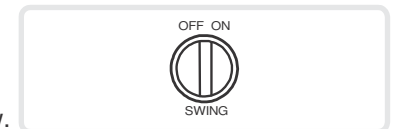

Horizontal Louvres

Manually adjust the horizontal louvres to change vertical airflow.

WARNING



- Before cleaning the unit, switch it to the "OFF" position and remove the plug from the power socket.
- To clean the outside, use a damp cloth to remove dirt and dust.
- Never use detergents, corrosive elements or any chemicals to clean this product.
- When the product is not in use, store the unit in a dry place out of direct sunlight..

CLEANING AND DRAINING THE WATER TANK

- To refill the tank during operation, turn the power "OFF" and disconnect the unit from the power supply.
- To clean the water tank, turn the unit "OFF" and disconnect the power supply. Move the unit to a location where it can be drained and remove the drain plug (**see number 12** on parts description on page 7). Once the tank is empty, refill it with clean water and drain it again. This should be repeated weekly to maintain the integrity of the unit and to remove particles filtered from the air.
- Once the tank is clean, refill the water tank. The unit is now ready to be used again.

CLEANING & MAINTENANCE

MAINTAINING AND CHANGING THE HONEYCOMB

- The appliance is supplied with Honeycomb cooling media.
- Draining the water reservoir and refilling with fresh water at least once a week will greatly reduce mineral deposits in the pads and help to extend the life of Honeycomb cooling media.
- Do not run the unit in COOL mode with stale water in the tank. It is recommended to empty the tank and refill it with fresh water if the water has been standing in the tank for an extended period of time
- The frequency for cleaning depends on local air and water conditions. For example, in areas where mineral content of the water is high, deposits may build up in the Honeycomb cooling media, restricting air flow. In this case, it is recommended to clean the Honeycomb cooling media every two months.
- For best results, allow the Honeycomb cooling media to dry after each use by turning off the cool function 15 minutes before turning the unit off.

TROUBLESHOOTING GUIDE

| PROBLEM | POSSIBLE CAUSE | SOLUTION |
|---------------------|------------------------|---|
| No discharge of air | Cord is not plugged in | Make sure cord is plugged in and try to turn the unit on by pressing buttons on control panel or remote control. |
| | Power is not on | |
| | Pump is not turned on | Turn on COOL function |
| | Low / No water | Refill water tank |
| Odour omission | Damaged pump | Replace pump. Contact service centre |
| | New unit | When the product is used for the first time the Honeycomb cooling media will have an odour which will dissipate within a week of initial use. |
| | Old unit | There may be an algae issue. Replace the Honeycomb cooling media. Contact service centre |

TROUBLESHOOTING GUIDE

| PROBLEM | POSSIBLE CAUSE | SOLUTION |
|----------------------|---|---|
| Unit is making noise | Calcium build up in blower | Contact service centre. |
| | Low or no water in the water tank when COOL is selected | Pump will make noise if water level is near empty. Refill water tank. |

Service Centre:
Scott Brothers Limited
1 Whiteside, Station Road,
Holmes Chapel, Cheshire
CW4 8AA, U.K.
Tel +44 (0)1477 539 500
Fax +44 (0)1477 539 530
Email sales@scott-air-cooling.co.uk

TECHNICAL SPECIFICATIONS

MODEL NO.

CL60PM

| | |
|---------------------|------------------------------|
| Voltage | 220-240 V |
| Frequency | 50 Hz |
| Wattage | 220 Watts |
| Water Tank Capacity | 60 Litre |
| Cooling Media | Honeycomb |
| Product Dimension | 700 (L) x 466 (W) x 1017 (H) |
| Net Weight | 19 Kg |
| Made in China | |

ELECTRICAL WIRING DIAGRAM

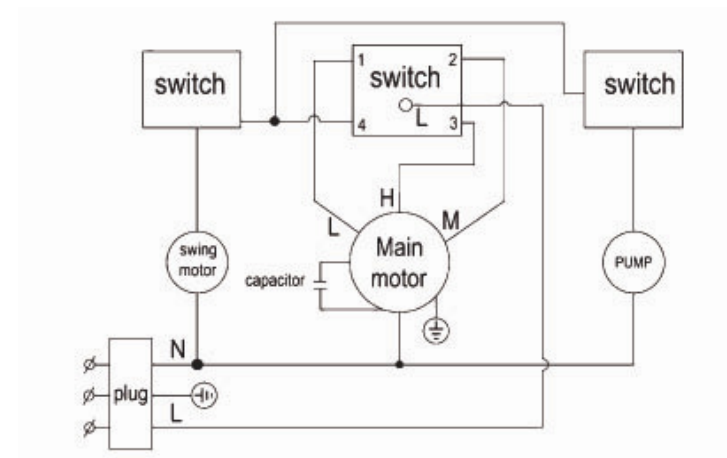

Honeywell

Warranty on Honeywell Cooler

We undertake by this Warranty to rectify free of charge any fault due to poor workmanship or faulty materials occurring in this Honeywell evaporative cooler within 1 year from the date of purchase. This undertaking is conditional upon the cooler being used only for personal domestic household or commercial purposes and installed and operated in accordance with our instructions and does not apply to consumable components such as cooling pads or adjustments as necessary due to the misuse of the cooler. Normal user maintenance is excluded.

The benefits conferred by this warranty are in favour of the original retail purchaser and any person deriving title to the goods under or through such person and are intended to be separate from additional to all other rights and remedies which they may have in law in respect of the goods.

The above warranty applies to the United Kingdom only.

This warranty is in addition to your statutory rights and does not affect them in any way.

This page is intentionally left blank

Autorised Distributor:
Scott Brothers Limited
1 Whiteside, Station Road
Holmes Chapel
Cheshire, CW4 8AA, U.K
Tel +44 (0)1477 539 500
Fax +44 (0)1477 539 530
Email sales@scott-air-cooling.co.uk

IM01-1009-000-000
December 2009
© 2009 AirTek International Corporation Limited
The Honeywell Trademark is used under license from
Honeywell International Inc.
Honeywell International Inc. makes no representation or
warranties with respect to this product.
Manufactured by AirTek International Corporation Limited.

Honeywell