

# User's Manual

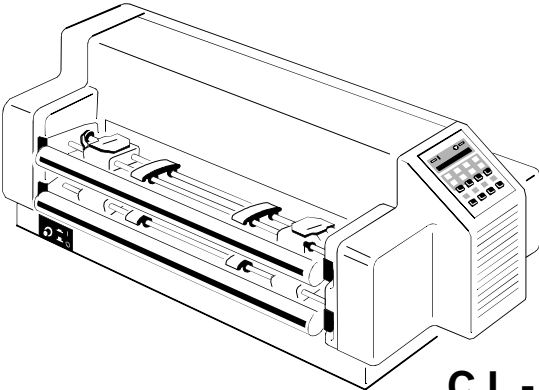

**CI - 4070**

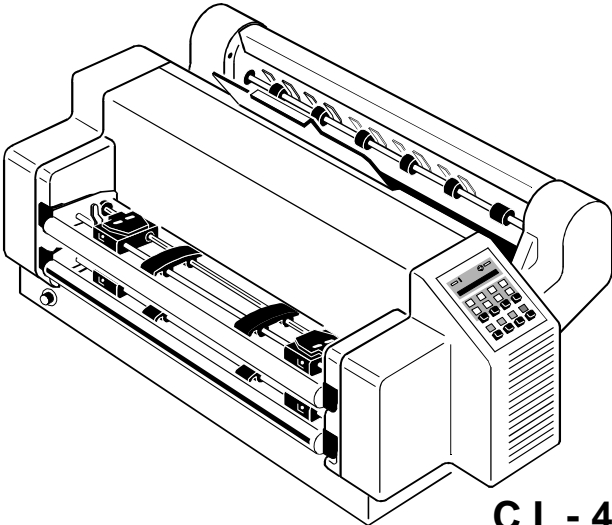

**CI - 4080**

## Acknowledgements

EPSON is a Trademark of Seiko Epson Corporation.

IBM is a Trademark of International Business Machines Corporation.

ProPrinter is a Trademark of International Business Machines Corporation.

---

A Publication of  
Output Solutions GmbH  
Bavierstraße 1  
D-40699 Erkrath  
Federal Republic of Germany

January 2002

Great care has been taken to ensure that the information in this handbook is accurate and complete. However, should any errors or omissions be discovered or should any user wish to make suggestions for improving this handbook, please feel encouraged to send us the relevant details.

The contents of this manual are subject to change without notice.

Copyright © by Output Solutions GmbH.  
All rights strictly reserved. Reproduction or issue to third parties in any form is not permitted without written authorization from the publisher.

---

## Safety Regulations

The printer **PP 407** (CI - 4070) and **PP 408** (CI - 4080) fulfils the safety regulations according to UL 1950 and VDE (IEC 950) and CNA/CSA 22.2 / No. 950 for computer systems.

The mains cable must be connected to a ground protected wall-socket. The selected voltage of the printer needs to agree with the local voltage.

The power plug must be easily accessible at any time so that it can be disconnected immediately in case of danger or for maintenance purposes.  
*Comme le câble de secteur sert de dispositif d'arrêt-urgence, sa connexion à l'imprimante doit être tout le temps accessible.*

Before installing the printer, check the surrounding conditions in which the printer will be placed (see next page, Operating Environment and chapter 1).

During a thunderstorm you should never attempt to connect or disconnect any data transfer cables.

The power supply should only be opened and checked by authorized personnel. Repairs and maintenance beyond the descriptions of chapter 4 may only be attempted by authorized personnel as well. Repairs done inappropriately may cause damage and severe danger for the user.

There is a warning symbols to draw the user's attention to possible injuries:



This symbol is visible when the top cover has been opened. It indicates that the print head is extremely hot after long periods of printing.

*Ce signal de danger se présente quand le cache supérieur de l'imprimante soit retiré pour indiquer que la tête d'impression peut être extrêmement chaude après imprimer très longtemps.*



This symbol is located on the cover of the cutting device. It cautions against touching the blade (only **CI - 4080**).

*Ce signal de danger se trouve sur le cache supérieur du massicot pour indiquer de ne pas toucher le couteau.*

## Electromagnetic Compatibility

We certify that the equipment at issue,

Type: **Printer PP 407** (CI - 4070) and **PP 408** (CI - 4080)

corresponds to the law regulations ruling electromagnetic compatibility of appliances (89/336/EWG) and, therefore, fulfils the requirements for conformity marking with the CE-sign.

This equipment has been tested and found to comply with the limits for a Class B digital device, pursuant to Part 15 of the FCC rules. These limits are designed to provide reasonable protection against harmful interference in a residential installation. This equipment generates, uses, and can radiate radio frequency energy and, if not installed and used in accordance with the instruction manual, may cause interference to radio communications.

However, there is no guarantee that interference will not occur in a particular installation. If this equipment does cause harmful interference to radio or television reception, it can be determined by turning the equipment off and on. The user is encouraged to try to correct the interference by one or more of the following measures:

- S Reorient or relocate the receiving antenna.
- S Increase the separation between the equipment and receiver.
- S Connect the equipment to an outlet on a circuit different from the circuit to which the receiver is connected.
- S Consult the dealer or an experienced radio/TV technician for help.

Shielded interface cables should be used with this unit to ensure compliance with Class B limits.

Changes and modifications not explicitly allowed by the equipment's manufacturer could void the user's authority to operate the equipment.  
*Changes et modifications pas expressément approuvés par le producteur peuvent dévaluer l'autorité d'opérer l'équipement.*

## Operating Environment

Avoid installing the printer where it is exposed to moisture or heat (eg. direct sun light).

S Temperature: + 10EC to + 35EC (+50EF to +95EF)

S Humidity: 20% to 80%

Slots and openings in the printer's housing are provided for ventilation. Always ensure that these openings are not obstructed.

Also ensure that the cables at the rear of the printer do not interfere with the output paper path.

When processing fanfold paper always place the printer with its front edge slightly off the edge of the table.

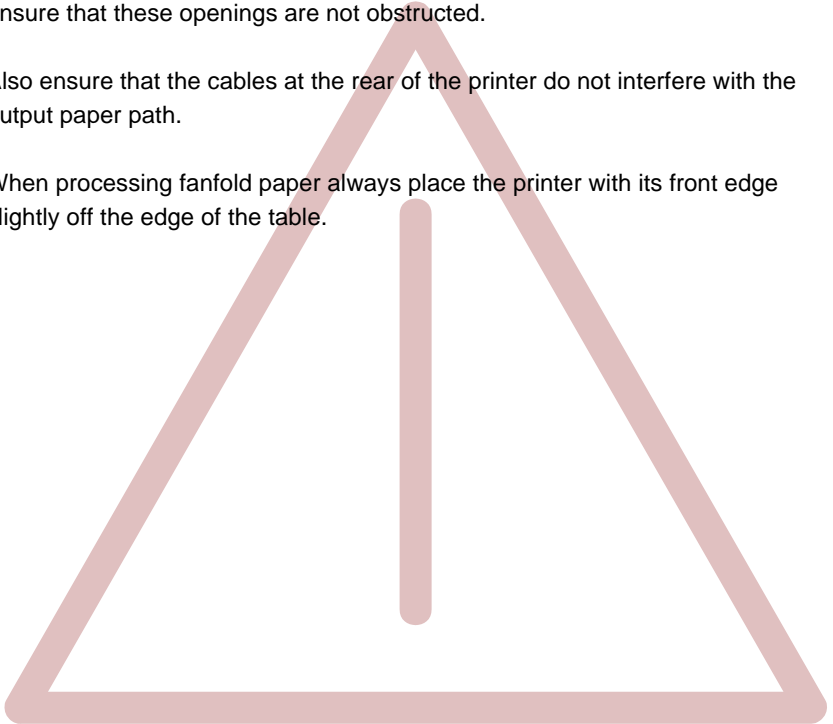

# Table of Contents

<b>Preface</b> .....	X
About this Manual .....	X
Conventions used in this Guide .....	XII
<b>1. Getting Started</b> .....	1-1
1.1 Unpacking .....	1-1
S CI - 4070 .....	1-1
S Transport Lock .....	1-3
S Repacking Information .....	1-3
1.2 Installing the Interface Module .....	1-4
1.3 The Power Supply .....	1-5
S Main Input Voltage Selection .....	1-5
1.4 Power ON/OFF Switch .....	1-6
1.5 Installing the Ribbon Cassette .....	1-7
1.5.1 Replacing on Cassette .....	1-9
1.6 Inserting Fanfold Paper .....	1-10
S Handling of the Tractor Cassettes .....	1-10
1.7 Paper Source Selection .....	1-12
1.8 Test Prints .....	1-13
1.9 Connection to a Computer .....	1-17
S Parallel/Serial Interface .....	1-17
1.10 Emulation Selection .....	1-18

<b>2. Printer Operation</b> .....	2-1
2.1 Control Panel .....	2-1
2.2 Function Keys .....	2-2
2.2.1 Short Description of Keys .....	2-2
S in the printer operation state <b>READY</b> or <b>BUSY</b> .....	2-2
S in the printer operation state <b>LOCAL</b> .....	2-2
2.2.2 Detail Description of Keys in the printer operation state <b>READY</b> or <b>BUSY</b> .....	2-3
S Quick Settings .....	2-3
S Top Row Keys .....	2-4
S Lower Row Keys .....	2-4
2.2.3 Meaning of the Keys in the LOCAL Mode .....	2-7
S Lower Row Keys .....	2-7
2.3 Menu Mode .....	2-8
2.3.1 To Activate the Menu .....	2-9
2.3.2 To Confirm Selection .....	2-10
2.3.3 How to Save Settings .....	2-11
2.3.4 Quick Settings .....	2-12

<b>3. Configuring the Printer</b> .....	3-1
3.1 What means Configuration .....	3-1
3.2 Standard Configuration .....	3-3
3.3 Explanation of the Printout .....	3-5
3.4 Explanation of Individual Menu Items .....	3-6
Main Functions .....	3-6
S MACRO SELECT .....	3-6
S CHANGE MACRO .....	3-6
S INSTALLATION .....	3-6
S SAVE .....	3-6
S PRINT OUT .....	3-7
Main Function CHANGE MACRO .....	3-7
S FONT .....	3-7
S PRINT QUALITY .....	3-8
S Font Quality .....	2-8
S Graphics Quality .....	2-8
S SUB/SUPER FONT .....	3-8
S PITCH .....	3-8
S LINE .....	3-8
S PAPER LENGTH .....	3-9
S VERT.POS.ADJ. ....	3-10
S LEFT MARGIN .....	3-10
S RIGHT MARGIN .....	3-11
S TOP MARGIN .....	3-11
S BOTTOM MARGIN .....	3-12
S PERFORATION SKIP .....	3-12
S PAPER SOURCE .....	3-12
S EMULATION .....	3-14
S CHARACTER SET .....	3-14
S LINE MODE .....	3-14
S \$\$ COMMANDS .....	3-14
S TEAR-OFF / CUT .....	3-15



Main Function INSTALLATION	
Sub-Function INTERFACE	3-17
S BUFFER	3-17
S WORD LENGTH	3-17
S I/F TYPE	3-17
S BAUD RATE	3-17
S PARITY BIT	3-17
S PROTOCOL	3-17
Sub-Function ADJUSTMENT	3-18
S AGC POSITION	3-18
S PLATEN GAP	3-19
S AGC ADJUST	3-19
S PAPER-IN ADJUST	3-19
S CUT. V-POS LO. / CUT. V-POS UP.	3-20
S UNI-DIRECT. CMD	3-21
S TRACTOR FORM FEED MODE	3-21
Special Menu Items under INSTALLATION	3-21
S LANGUAGE	3-21
S RESTORE NENU	3-21
S RECALL FACTORY	3-21
S MENU ACCESS	3-22
S SELF TEST	3-23
S HEX DUMP	3-23

## Menu Tree

<b>4. Maintenance</b>	4-1
S Preferred Materials	4-1
4.1 Cleaning the Platen and Surrounding Areas	4-1
S Print Test 3	4-2
4.2 Cleaning Procedure	4-3
4.3 User Replaceable Parts	4-4
4.3.1 Replacement of the Print Head	4-4
S Print Head Removal	4-4
S Print Head Installation	4-5
4.3.2 Replacement of the Platen	4-6
S To Remove the Platen	4-6
S To install the Platen	4-7
<b>5. Trouble Shooting and Diagnostics</b>	5-1
S How to Use this Section	5-1
5.1 Power-related Problems	5-2
5.2 Error Messages	5-2
5.3 No Printout	5-7
5.4 Operation-related Problems	5-8
5.5 Print-related Problems	5-9
5.6 Paper Jam	5-11
5.7 Ribbon or Carriage-related Problems	5-13
5.8 Print Tests	5-13
<b>6. Technical Data</b>	6-1

Appendix A	<b>System Interface Descriptions</b>	A-1
1	Serial Interface RS 232 C	A-2
	S Interface Characteristics	A-2
1.2	Transmission Protocols	A-3
1.2.1	DTR - Ready/Busy	A-3
1.2.2	XON / XOFF	A-6
2	Parallel Centronics® Interface	A-7
2.1	Interface Characteristics	A-7
2.2	Transmission Protocol Description	A-8
2.3	Timing Diagram	A-9
3	Shared Operation	A-10
Appendix B	Print Samples of Resident Fonts	B-1
Appendix C	Character Set Table	C-1
Appendix D	IBM ProPrinter 4207, 4208 XL 24 Quick Reference	D-1
Appendix E	EPSON LQ 2550 / ESC/P2 Quick Reference	E-1
Appendix F	Barcode Quick Reference	F-1
Appendix G	Information for the System Manager	G-5

# Preface

## About this Manual

This manual covers the printer in combination with an interface module (Personality Module).

The Personality Module (PM) is an integral part of the printer, and the type of PM used determines the functionality of the printer especially regarding the user and system interface.

The structure of this manual is such that the operator is led step-by-step through the various procedures. It starts with the unpacking and setting-up, moves on to detailed instructions for operating the printer and ends with the mounting of options.

The manual is divided into the following chapters:

### 1. Getting Started

This chapter covers the unpacking and setting-up of the printer and the installation of the PM (Personality Module) and ribbon cassette. By the end of this chapter the printer should be fully functional and tested in its primary form. It is not yet connected to the host computer system and no options are mounted.

### 2. Operating the Printer

This chapter discusses in great detail the operation of the operator panel, all menu functions, and the general operation of the menu.

### 3. Configuring the Printer

This chapter explains how to configure the printer so that it can communicate with the corresponding system environment. Then this chapter thoroughly describes the printer's operating controls. In the last part you will find explanations of individual menu items. At The end of this chapter you will find the Menu tree.

#### **4. Maintenance**

shows how to clean the printer and how to replace the platen and the print head.

#### **5. Trouble Shooting and Diagnostics**

suggests how to identify and correct simple problems.

#### **6. Technical Data**

All technical details or data about the printer can be found here.

### **Appendix**

#### **A. Interface Description**

This chapter gives hints about possibilities to connect the printer to the various computer systems and explains particularities depending on the version of the operating system. Additionally, cable connection is illustrated.

#### **B. Print Samples of Resident Fonts**

#### **C. Character Set Table**

All printer supported character sets are listed in this chapter.

#### **D. Control Codes**

Quick reference for IBM ProPrinter and IBM ProPrinter AGM (4207, 4208 XL 24) Emulation.

#### **E. Control Codes**

Quick reference for EPSOM LQ 2550 / ESC/P2 Emulation.

#### **F. Control Codes**

Quick reference for Barcode programming.

#### **G Miscellaneous**

S System Manager Information

## Conventions Used in this Guide

The following conventions are used:

<b>Bold</b>	Headlines and important information.
<b>Note:</b>	Contains special advice to facilitate handling.
<b>Caution:</b>	Contains important information to prevent damage of the equipment.
[ENTER]	Key functions are always depicted in brackets or you will find the symbol of the key e.g.  .

## Abbreviations and Acronyms

DRAFT	<b>Draft</b> Quality
EE	<b>E</b> astern <b>E</b> uropean
LCD	<b>L</b> iquid <b>C</b> rystal <b>D</b> isplay
LED	<b>L</b> ight <b>E</b> mitting <b>D</b> iode
LQ	<b>L</b> etter <b>Q</b> uality
MACRO	User defined group (1 bis 4) of stored parameter
NLQ	<b>N</b> ear <b>L</b> etter <b>Q</b> uality
PH	<b>P</b> rint <b>H</b> ead
PM	Interface ( <b>P</b> ersonality <b>M</b> odule)

## Note!

The following chapters describe the two printers:

- S **CI - 4070** Fanfold printer without cutter
- S **CI - 4080** Fanfold printer with cutter

The operation of both printers is mostly alike. In most illustrations, the printer with the cutter is used. In case there are differences in the handling you will find the note **CI - 4070** or **CI - 4080**.

# 1. Getting Started

## 1.1 Unpacking

Check each item against the check list detailed below. Contact your delivery agent immediately if any item is missing or damaged.

The printer package for the **CI - 4070** should contain the following parts:

- |   |   |   |                           |
|---|---|---|---------------------------|
| S | 24-Needle Printer (1)                       | - | Quick Reference Guide (2) |
| S | Ribbon cassette (3)                         | - | Power cord (4)            |
| S | Two tractor cassettes (5) (already mounted) |   |                           |
| S | Top cover (6) (already mounted)             | - | CD-ROM (7)                |

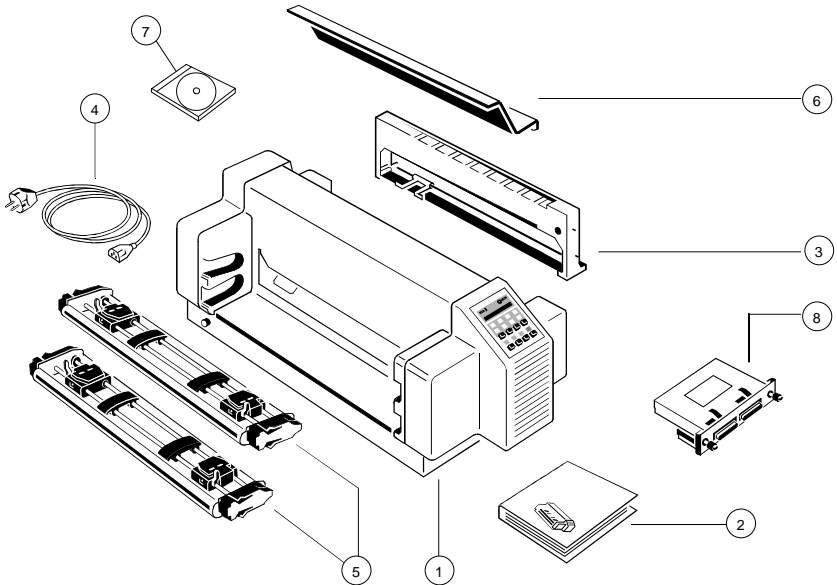

A separate box contains the Personality Module (8).

The printer package for the **CI - 4080** should contain the following parts:

- S 24-Needle Printer (1)
- S Cutting Device (2) (separate packing - see Packing Note)
- S Ribbon cassette (3)
- S Power cord (4)
- S Two tractor cassettes (5) (already mounted)
- S Top cover (6) (separate packing - see Packing Note)
- S Quick Reference Guide (7)
- S CD-ROM (8)

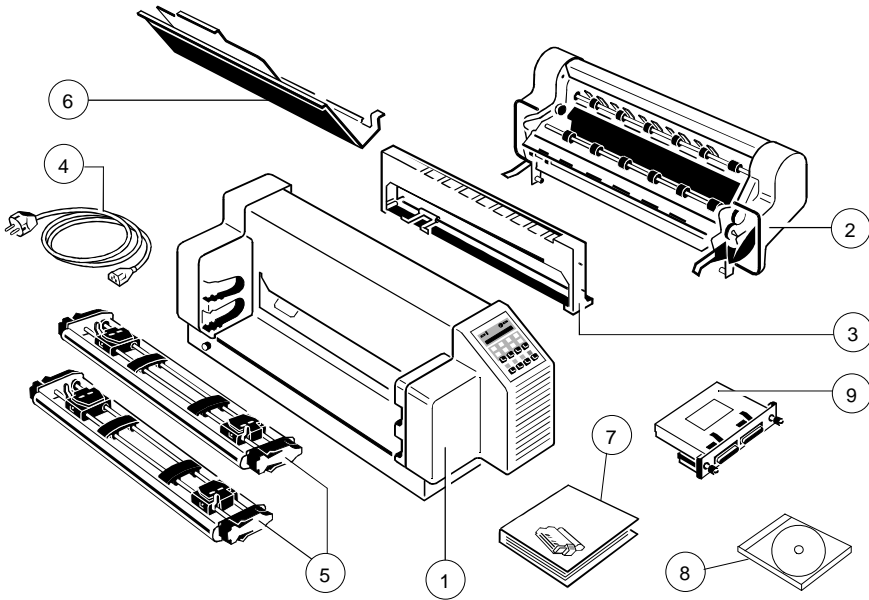

A separate box contains the Personality Module (9).



**Note:** Mount the Cutter and the Top Cover (only for the **CI - 4080**) as described in the enclosed Packing Note.

Do not connect to the mains until the mains voltage selection has been checked and the PM is installed.

### **Repacking Information**

Save all packing material and boxes for future transportation of the printer.

To ensure maximum protection when transporting the printer, please pay attention to the following:

1. Push the output stacker into the top cover and remove the power cord.
2. Remove the ribbon cassette.
3. Pack the complete printer in its original packing box and ship it.

**Pay attention to the 'Packing Note'!**

## 1.2 Installing the Personality Module

The printer functions only in combination with an installed interface module, called a Personality Module (PM).

The illustration below shows the standard PM with a serial and parallel interface. For detailed information about your PM, see Chapter 2.

**Note:** - To avoid damage due to electrostatic discharge, do not touch the pins or components of the PM.

- Never attempt to install or remove a PM while the printer is switched ON.

1. Remove the PM (16) from its packing material.
2. Insert the Personality Module (16) with the component side upwards until the connector fully engages. Hand tighten the two lock screws (17).

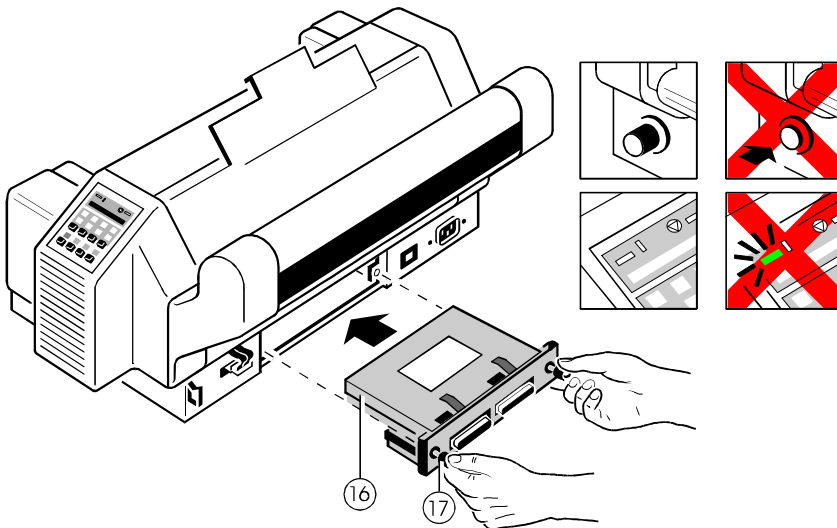

## 1.3 The Power Supply

### Mains Voltage Selection

In general, the mains voltage selection is determined at factory site.

Since an incorrect voltage selection can seriously damage the printer, please pay special attention to the following:

1. Make sure that the specified voltage on the voltage selector (8) corresponds to your mains voltage:  
either 230 V for 180 to 264 V alternating current  
or 115 V for 90 to 140 V alternating current.
2. If it is necessary to change the voltage, slide the selector button to the required voltage selection.
3. Connect the printer to the mains using the power cord (4). First connect the cable to the power cord socket and then to the mains.

**Note:** As the power cord serves as a safety cut-off, its connection to the printer must be accessible any time.

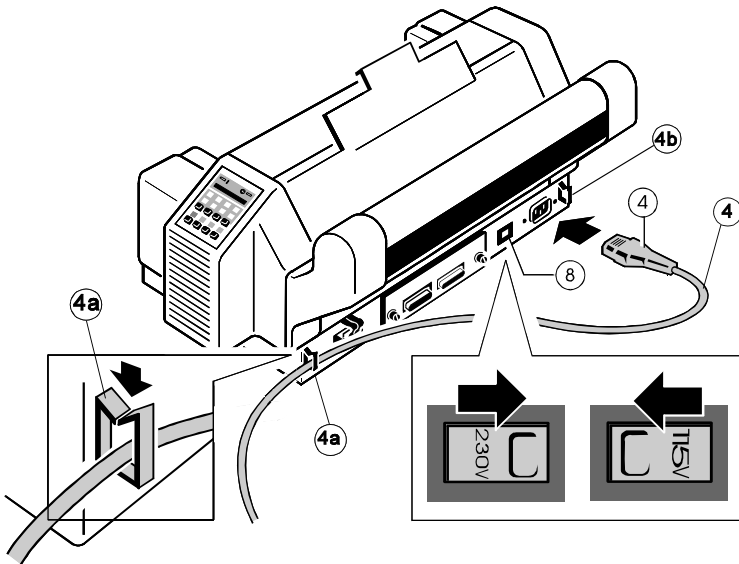

## 1.4 Power ON/OFF Switch

The power ON/OFF switch (10) turns the printer's power supply ON or OFF.

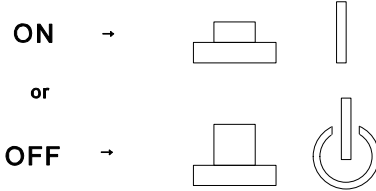

When switched **ON** the printer performs an internal self-test which checks the electronics, the print head carriage movement and the interface. Power ON is indicated by a green LED on the operator panel (53).

When the internal test has been completed successfully the display shows **READY 1 ELQ** (or **BUSY 1 ELQ** in case data has already been transmitted). If an error occurs the display will show an error message and the printer enters the STOP mode (see chapter **5.2 Error Messages**).

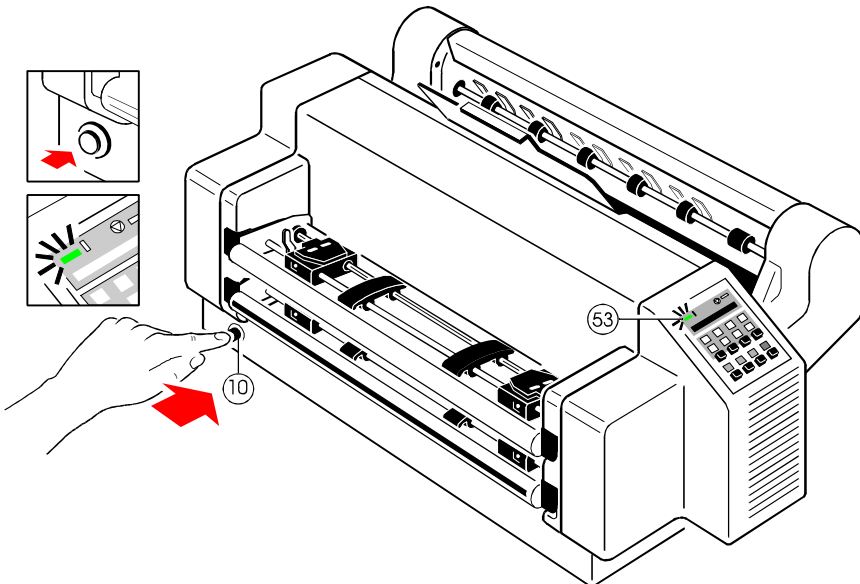

## 1.5 Installing the Ribbon Cassette

It is recommended to use only original ribbon. Using other ribbons will void your warranty.

**Caution:** Never manually move the print head (11) fully to the right hand stop.

**Note:** Always press  [START/STOP] before opening the top cover.

1. Switch the printer ON at the power switch (10); Power LED (53) is lit.
2. Press  .
3. Lift the top cover (6) to gain access to the ribbon cassette mounting. The print head (11) will move to the correct position, aligned with the cut-out in the paper guide plate (12) to facilitate the installation of the ribbon cassette.
4. Remove any excess slack by turning the green knob (14) on the ribbon cassette clockwise. Move the ribbon feed guide (13) to the position indicated on the plastic cover of the cassette (2a).

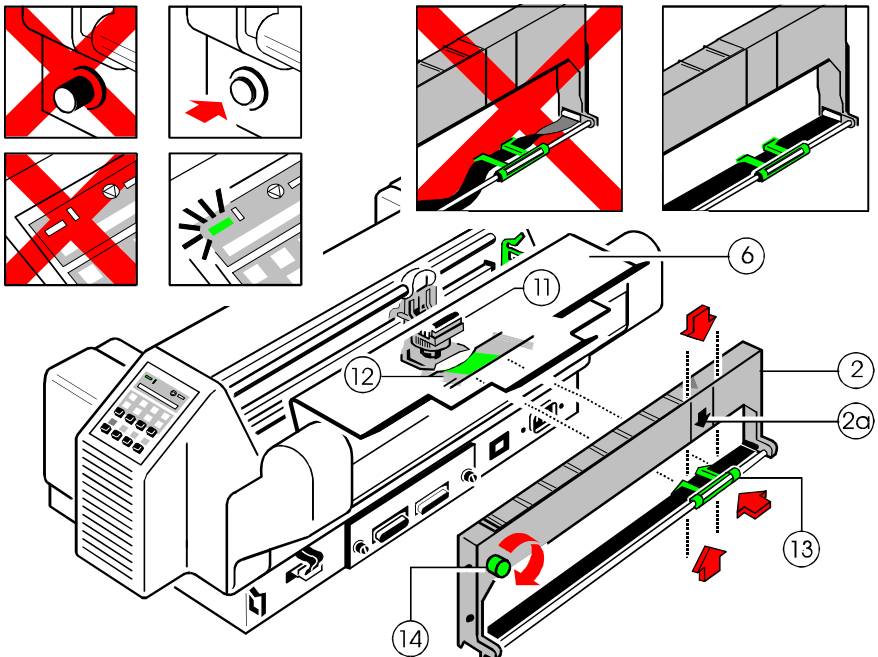

5. Position the ribbon feed guide (13) between the print head (11) and the green plastic plate (15).
6. Fit the upper mounting pins into the green mounting brackets and gently move the cassette toward you until you hear a click on both sides. Swing the ribbon underneath the print head until the lower mounting pins also engage with a click on both sides. The audible clicks indicate that the mounting pins have engaged properly.

**Note:** At each end of the ribbon cassette there are two pins [1.] and [2.] which keep the cassette in position when mounted. When installed correctly the ribbon cassette IS NOT PARALLEL to the printer's housing.

7. Move the print head (11) back and forth to settle the ribbon in the correct position.
8. If necessary remove excess ribbon slack by turning the green knob (14) clockwise.
9. Close the top cover (6) and press  .

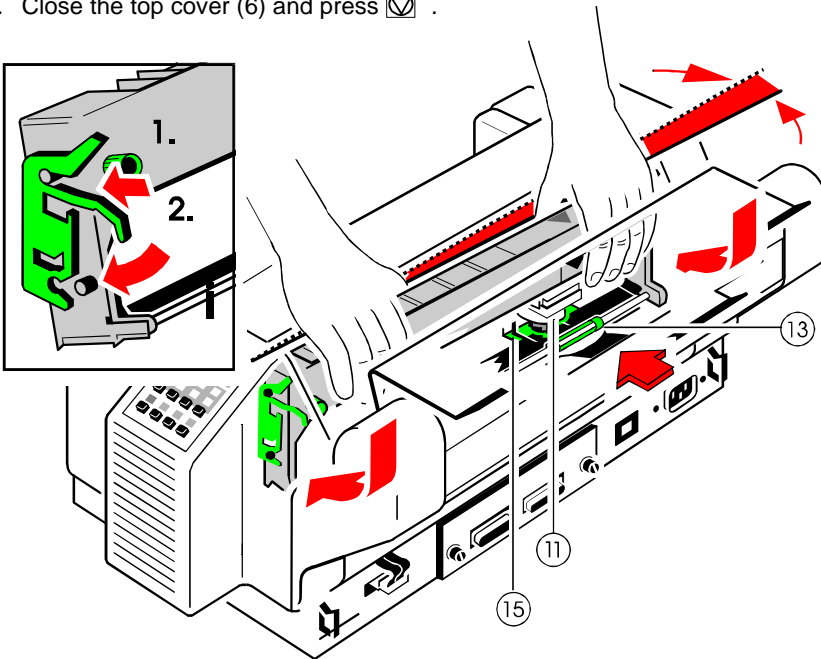

### 1.5.1 Replacing the Ribbon Cassette

**Caution:** The print head may be very hot immediately after printing!

1. Lift the top cover (6) to gain access to the ribbon cassette mountings. The print head (11) will move to the correct position, aligned with the cut-out in the paper guide plate (12) to facilitate the installation of the ribbon cassette.
2. Now swing the lower part of the ribbon cassette to the rear. In this way the mounting pins [1.] loosen from the lower position.
3. Then press the upper part of the ribbon cassette to the rear. The upper mounting pins [2.] get free and the ribbon cassette can be taken out.
4. To install a new ribbon cassette please see **1.5 Installing the ribbon cassette** .

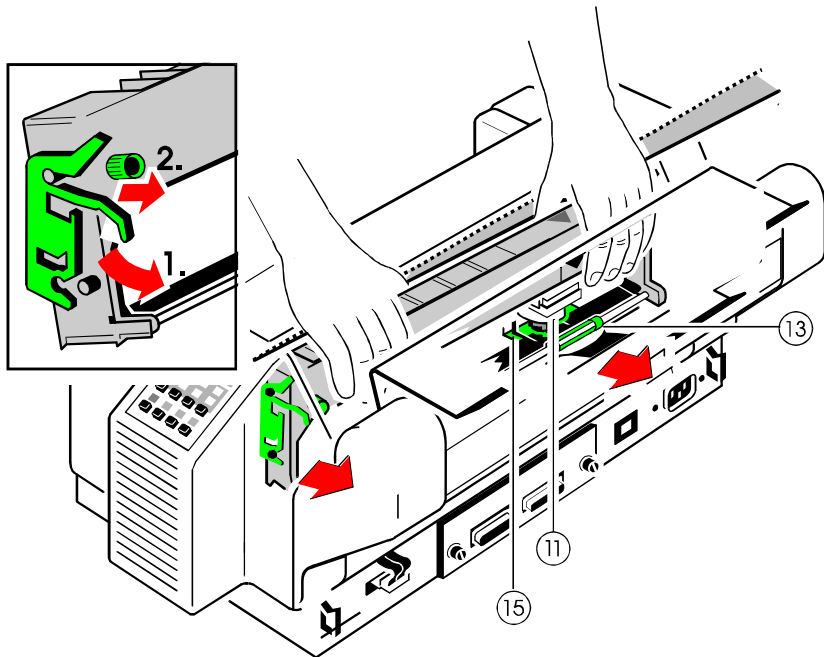

## 1.6 Inserting Fanfold Paper

The printer has two tractor cassettes (5) for fanfold paper i.e. the **LOWER TRACTOR** cassette (default) and the **UPPER TRACTOR** cassette.

Ensure that the printer is placed in the depression on the top of the stand (option). If the printer is used without a stand, align the printer with the front edge of the table. The cables at the back of the printer should be tucked into the cable clips in order not to block the paper path.

### Handling of the Tractor Cassettes

Simply slide the tractor cassettes forward into the respective guides until you hear a click (see illustration). Remove the tractor cassettes by lifting and pulling them toward you. Take out the **UPPER TRACTOR** before inserting paper into the **LOWER TRACTOR**. If more than two different fanfold papers are to be processed, it is useful to work with additional tractor cassettes. They can be loaded with paper in advance and just need to be plugged into the printer as required.

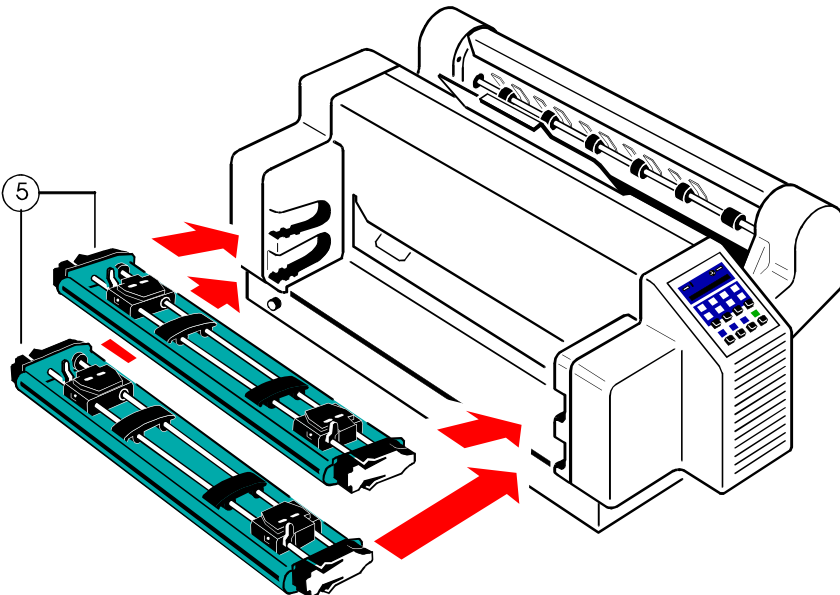



Insert the paper as shown in the illustration; the top edge of the paper must be equal with the top of the tractors or maximum up to two transport holes above the tractors. The left perforation should be aligned with the center mark on the plastic plate.

Paper without vertical perforation should be aligned in such a way that the left holes are positioned to the left of the center mark on the plastic plate (25).

### Inserting paper for the first time or changing to another paper width:

1. Pull the green tractor lock levers (22) forward to release the tractors (23).
2. Roughly adjust the tractors (23) to the paper width, and space out the paper supports (24) evenly.
3. Open the tractor covers (21) and insert the paper in such a way that the top edge partly covers the plastic plate (25).
4. Close the tractor covers (21) and move the tractors with the paper until the left perforation is aligned with the center mark on the plate (25).
5. Lock both green tractor levers.

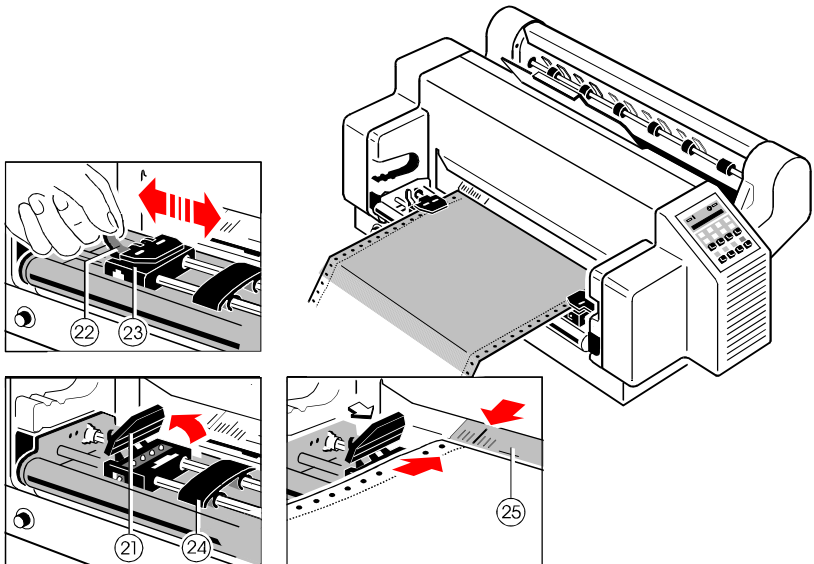



**Note:** The pins of the tractor must be centered in the transport punches of the paper.

### 1.7 Paper Source Selection

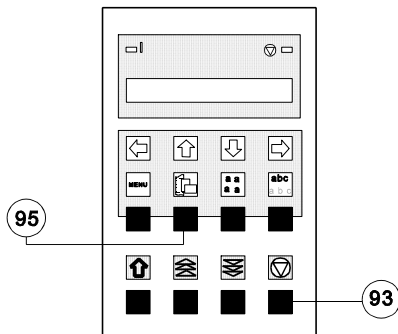
The **LOWER TRACTOR** is the default paper source. Using the control panel to change to the **UPPER TRACTOR** is explained below:



Key	Display
1. Switch the printer on.	
2.  (93)	LOCAL
3.  (95)	7 TRACTOR LOWER *
4. [N]	7 TRACTOR UPPER
5. [Y]	7 TRACTOR UPPER *
6.  (93)	READY            1 ELQ

**Note:** If fanfold paper is already be printed while changing the paper source it will be depending on the printer type offerd for tear off ore moved forward, cut, and moved to the **parkposition**. In this case are four transport holes above the tractors.



## Getting Started

Eilzustellung

Norddeutsche Farbwerke KG  
Herrn Dr. Grauert  
Große Elbstraße 64

2000 Hamburg 4

Org. III 5/37                      H-A                      4 43                      22.04.75  
17.04.75                      Volkmann

Vordruckgestaltung für den allgemeinen Schrift-  
verkehr, für das Bestell- und Rechnungswesen                      E i l t

Sehr geehrter Herr Dr. Grauert,

Sie können das Schreiben der Briefe, Bestellungen, Rechnungen usw.  
sowie das Bearbeiten des Schriftguts rationalisieren, wenn die  
Vordrucke Ihres Unternehmens den folgenden Normen entsprechen:

DIN 676 Geschäftsbrief; Vordrucke A4  
DIN 677 -; Vordruck A5  
DIN 679 Geschäftspostkarte; Vordrucke A6

DIN 4991 Vordrucke im Lieferantenvorkehr; Rechnung  
DIN 4992 -; Bestellung (Auftrag)  
DIN 4993 -; Bestellungenannahme (Auftragsbestätigung)  
DIN 4994 -; Lieferschein/Lieferanzeige  
DIN 4998 Entwurfsblätter für Vordrucke

Diese Normen enthalten alle Einzelheiten für den sinnvollen und  
zweckmäßigen Aufdruck. Wenn dazu bei der Beschriftung genormter  
Vordrucke DIN 5008 'Regel für Maschinenschreiben' beachtet wird,  
entstehen übersichtliche und werbewirksame Schriftstücke.

Die beigefügten 6 Mustervordrucke zeigen, daß das Beachten der  
Normen die künstlerische und werbewirksame Gestaltung der Vor-  
drucke nicht ausschließt.

Da wir uns auf die Herstellung genormter Vordrucke spezialisiert  
haben, können wir besonders billig liefern. Eine Probestellung  
wird Sie und Ihre Geschäftsfreunde von den Vorteilen überzeugen.

Mit bester Empfehlung

NORAG  
Druckerei und Verlagshaus KG

Herrmann

Anlagen



6 Mustervordrucke

PRINT TEST 2

To start a print test:

1. Switch the printer ON (display shows **READY 1 ELQ**).

The following identifies the keys to press and the corresponding operator panel messages.

KEY	Display
2.  (93)	LOCAL
3.  (94)	MACRO SELECT 6
4. [N] -- [N]	INSTALLATION 6
5. [Y]	7 INTERFACE 6
6. [I] -- [I]	7 SELF TEST 6
7. [Y]	7 PRINT TEST 1

Use [N] to select PRINT TEST 2 or 3.

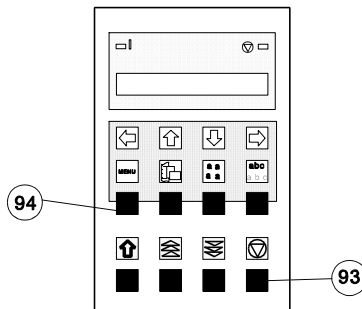

8. [Y]	7 PRINT TEST 1	*
9.  (93)	PRINT TEST 1	*

The printer starts to print using paper from the defined paper source.



Getting Started

To stop the print test:

1.  (93)                      7 PRINT TEST 1                      \*
2. [Z]                                      7 SELF TEST                                      6
3.  (93)                                      READY                                      1 ELQ

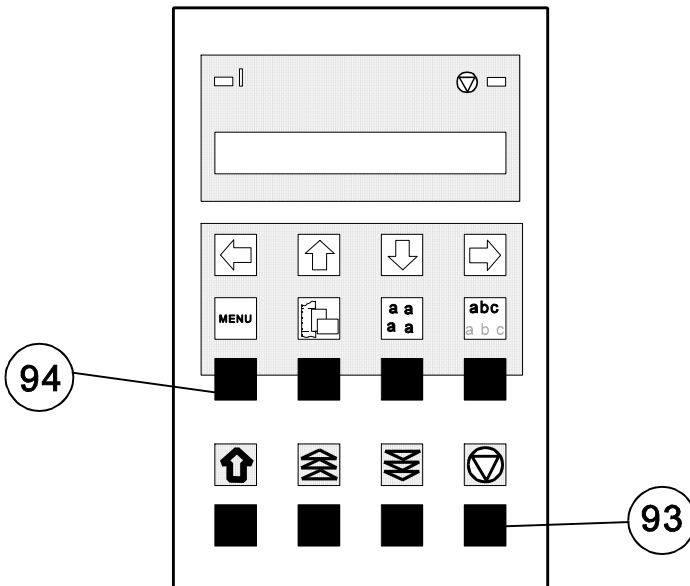

## 1.9 Connection to a Computer

### Parallel/Serial Interface

- S Switch the printer and computer OFF.
- S Connect the interface cable coming from the computer to the printer's parallel (27) or serial port (28).
- S The printer is by default set to SHARED interface mode with the following parameters:
  - S 8 Kbyte buffer
  - S 8 bit
  - S even parity
  - S 9600 baud
  - S DTR protocol

SHARED means that, after Power-ON, both the serial and the parallel interface are available for data transfer. The port to which data is sent becomes active automatically. If the parallel or serial parameters need to be changed, see Appendix A, **Interface Description**..

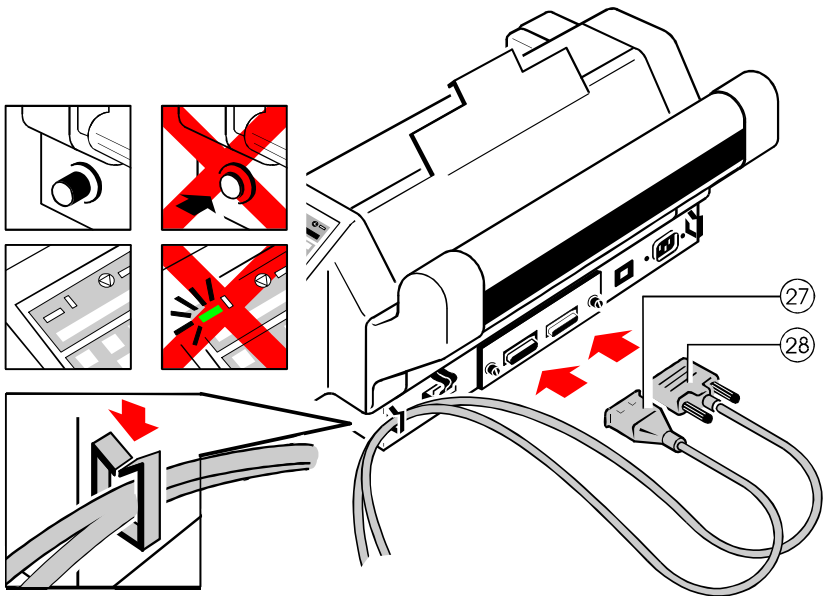

## 1.10 Emulation Selection

The following emulations are included in the PM Ser/Par:

S EPSON LQ (Default)	in Macro 1
S IBM Proprinter XL 24	in Macro 2
S IBM Proprinter XL 24 AGM	in Macro 3
S EPSON LQ	in Macro 4

To change from one emulation to another, follow the procedure below. The example shows the keys to press along with the display information for a change from **EPSON LQ** in macro 1 to **IBM PROPR.** in macro 2

1. Switch the printer ON. The display shows **READY 1 ELQ.**

2.  MACRO 2 6

3. [Y] READY 2 IPP

The information **READY 2 IPP** indicates the selected macro and the emulation of this macro, for example:

1 ELQ	Macro 1 with Epson Emulation.
2 IPP	Macro 2 with IBM Proprinter Emulation
3 AGM	Macro 3 with IBM Proprinter AGM Emulation
4 ELQ	Macro 4 with Epson Emulation.



## 2. Printer Operation

### 2.1 Control Panel

The control panel

S controls the set-up for communication with the host computer

S controls various parameter settings

S allows manual control of the paper handling

S gives information about the printer's status.

**The 16-character Liquid Crystal Display (LCD)** (51) indicates the current status of the printer. If an error occurs (e.g. COVER OPEN), the resulting error message overrides any other displayed message. When the error condition no longer exists, the original status information appears on the display.

**The green Power ON indicator** (53) is lit when the printer is supplied with power by setting the power ON/OFF switch to ON.

**The yellow STOP indicator** (52) is lit when the printer is in the STOP mode.

The printer enters the STOP mode either when  (93) is pressed or when an error condition occurs such as NO PAPER, COVER OPEN, etc.

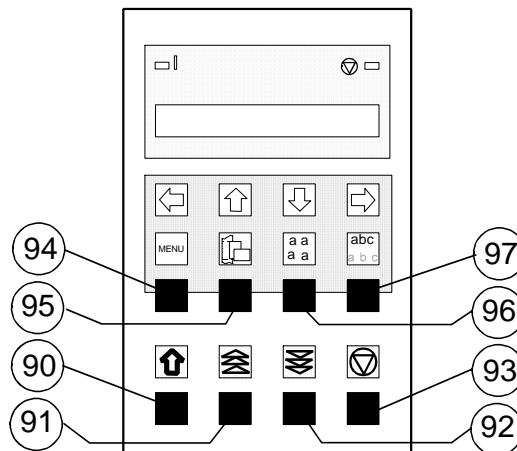

## 2.2 Function Keys









The function keys of the operator panel are grouped into two rows. The function of a key depends on the printer operation state. Following operation states are possible:

S **READY** or **BUSY**

S **LOCAL**

### 2.2.1 Short Description of Keys









- in the printer operation state **READY** or **BUSY**





Number	Symbol	Functionality in ONLINE/READY Mode
90		<b>Quick VERT.POS.ADJ.</b> setting entry
91		<b>FANFOLD DISPLACEMENT</b> mode entry
92		No function
93		[START/STOP] key - after pressing the key, the printer enters the <b>LOCAL</b> mode.
94-97	   	<b>MACRO SELECTION</b> to enter the quick macro selection mode.

**Note:** It is possible to lock the function of the above described keys in the printer operation state **READY** or **BUSY**. Use the menu function **MENU ACCESS** with the setting **QUICK SET OFF** (see **Page 3-22**). If the keys are locked the printer shortly displays **LOCKED** when pressing one of the keys.

It is not possible to lock  .

- in the printer operation state **LOCAL**

Number	Symbol	Functionality in LOCAL Mode
90		<b>EJECT FORM</b>
91, 92	 	Paper movement up and down
93		<b>START/STOP</b> key - after pressing the [START/STOP] key, the printer enters the <b>READY</b> or <b>BUSY</b> mode.
94		<b>MENU</b> key - to enter the Menu Mode in the first level.
95		<b>PAPER SOURCE</b> key - to start the paper source selection.
96		<b>FONT</b> key - to start the font selection.
97		<b>PITCH</b> key - to start the pitch selection or to confirm a certain set up, or to confirm the quick macro selection.

**Note:** After pressing one of the keys     the menu mode is activated. Now the keys of the top row can only be used as cursor keys to move within the menu tree (right [Y], left [Z], up [[] and down [\]).

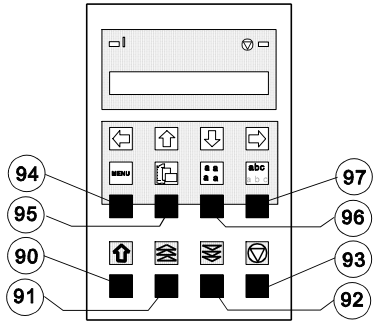



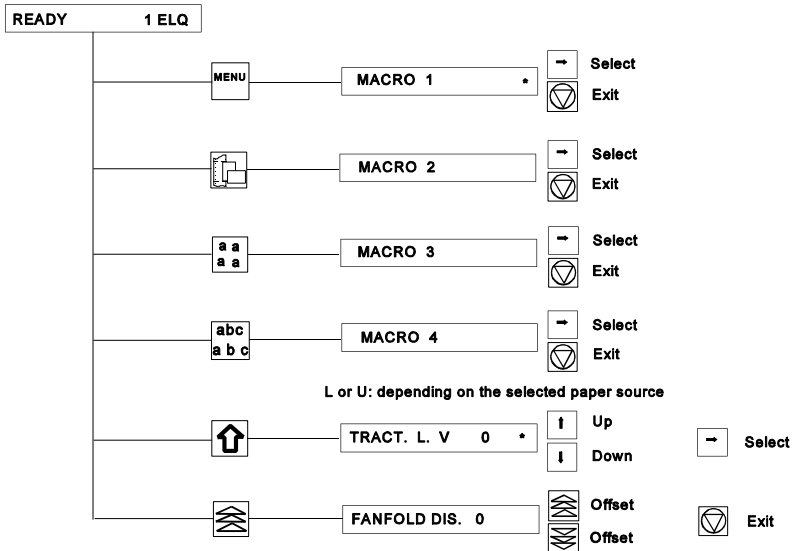

### 2.2.2 Detail Description of Keys

S in the printer operation state **READY** or **BUSY**

S **Quick Settings** (only active if not locked in the menu function **MENU ACCESS** with **QUICK SET OFF** (see **Chapter 3**)).



## S Top Row Keys

The **Quick Macro Selection** mode is entered when one of the top row keys  ,  ,  or  is pressed. From the left to the right macro 1 to macro 4 will be selected. Pressing of key  causes the printer to change in the **STOP**-mode and in the display appears the message **MACRO 2**. Pressing key [Y] confirms the macro selection and changes the printer into the **READY** or **BUSY** mode. After this sample the printer the message on the display is **READY 2 IPP**. That means macro 2 with IBM ProPrinter emulation is selected.

If you press one of the above described key erroneously, press  for correction.

**Note:** Macro selection means a change of all configuration parameters of the macro concerned.

## S Lower Row Keys

In case a certain application requires a specific vertical positioning of the printout on a continuous form, two possibilities are provided for the **READY** or **BUSY** mode:

S vertical position adjustment **VERT.POS.ADJ.** with key  (90)

S fanfold displacement **FANFOLD DIS** with key  (91).

### S Vertical Position Adjustment (**VERT.POS.ADJ.**) (90)

This can be set differently for each macro to exactly position the printout in relation to the top edge of the form in use. Using this function, the TOP MARGIN and BOTTOM MARGIN settings are taken into account as well.

The parameter is part of the printer's configuration set up memory and can be stored with the **SAVE** function.

The **VERT. POS.ADJ.** mode can directly be called up in the status **READY** or **BUSY** by pressing key  . In this case a set up is possible for the actually paper source of the selected macro. With **TRACT. L. V** or **TRACT. U. V** the printer asks for the value of the lower or upper tractor.



This parameter covers a range of  $-^{15}/_{60}$  to  $+^{240}/_{60}$  of an inch (0.42 mm), where "-" is up the page and "+" is further down the page (see also the table in Chapter 3.4 **Configuring the Printer for VERT.POS.ADJ.**).



**Note:** The set up of **VERT.POS.ADJ.** will become effective at the next page of the form. Therefore, it is recommended to perform **VERT.POS.ADJ.** set up as long as the paper is in the park position and before starting the print job.

### S Fanfold Displacement (**FANFOLD DIS**) (91)

A continuous form can manually be displaced by this function when it is either correctly loaded at the park position or already fed and partly printed. The Fanfold Displacement mode can only be called up in the status **READY** or **BUSY**.

**Note:** The key  has no effect when in the **READY** or **BUSY** mode.

As soon as the Fanfold Displacement mode is entered by pressing  , the printer stops printing and changes into the **LOCAL** mode. The display shows the message **FANFOLD DIS** with the value **0**. By pressing  (91) or  (92) a vertical displacement is possible.







	Key	Display
1		READY 1 ELQ
2		FANFOLD DIS 0
3		FANFOLD DIS 0, +1, +2, +3...
4		FANFOLD DIS ....+3, +2,+ 1, 0
5		READY 1 ELQ

**Note:** This parameter influences the line counter of the current print job and cannot be saved. A form feed (FF) sent by the application to the printer cancels all these settings.

### How to Use this Function

Preprinted paper (e.g. bill of lading) has to be adjusted exactly. Following errors are possible:

- S the printed value is too high - the fanfold paper has to be moved a little bit higher.
- S the printed value is too low - the fanfold paper has to be moved a little bit lower. No backward movement is possible for a form in park position or with the print head on the first line. The displacement will become effective on the next page. A negative displacement is possible if this function is used during a current print job (not at the beginning of the page).

After pressing  again, paper is fed in case it was in the park position. In all other cases the paper remains at its actual position. Each further pressing of  increases the line counter by increments of  $\frac{1}{60}$  inch. Each further pressing of  decreases the line counter by decrements of  $\frac{1}{60}$  inch. Holding of  or  causes the first 20 increments in single steps ( $\frac{1}{60}$  inch), thereafter in multiplier of ten which results in a continuous increment or decrement of the offset counter by  $\frac{1}{6}$  inch. If the reached value is too high go backwards by pressing  .

The offset to the current position is shown on the display. Dependent on the status of the internal print buffer, the offset will be immediately executed after having resumed the printing or after having printed the remaining data in the internal print buffer. The offset value is not stored in the configuration set up and influences only the actual line counter. The maximum displacement range is the distance between the actual position and the page border plus one full page, but no more than 999 steps (nearly 1 inch). A backward movement is possible from the actual position to the top of that page.

If the setting is procedure is completed change with  (93) to the **READY** or **BUSY** mode.

There are two possibilities for the displacement to become active:

- S If a positive displacement is set before starting the print job the printer will move the paper into the right position first and then start printing.
- S If the displacement is set during a print job, the printer prints the contents of the print buffer. Afterwards, the displacement will become active. All following data are at the new position.

- S Pressing [START/STOP]  (93)

The printer changes into the **LOCAL** mode (displayed) and turns on the STOP indicator (52). All printer and paper handling operations are stopped. After pressing  again, the printer quits the **LOCAL** or **Menu** mode.

### 2.2.3 Meaning of the Keys in the LOCAL Mode

#### S Lower Row Keys

- S **Insert or Eject Key**  (90)

After pressing the Insert/Eject key, fanfold paper from the park position is fed into the print position, and fanfold paper from the print position is fed into the cut/tear off position (depending on the setting or the printer type). Paper that has been retracted into the cut/tear off by the Insert/Eject key will be moved automatically into the print position once the printer receives a print command.

**Note:** This key is not active while the top cover is open.

- S **The Paper Feed Key**  (91) **and the Reverse Paper Feed Key**  (92)

The paper moves  $\frac{1}{90}$ " (0.28 mm) in the direction of the arrows. Holding down the key results in continuous feeding.

Forward movement of paper from the park position is stopped at the print position. Forward movement of paper from the print position is stopped at the tear off position or it will be cut off (depending of the setting or of the printer type).

Backward movement of paper is stopped at either the park position, the print position or the tear off position.

- S **START/STOP** Key  (93)
- S turns off the STOP indicator
- S makes the printer ready for operation
- S either starts the printout or self-test functions when selected (see MENU mode) or causes the interface status to change to **READY** or **BUSY** (displayed)
- S exits the MENU mode.

## 2.3 Menu Mode

Instead of having a multitude of dip switches, all operator selectable features are accessible via the control panel and combined in the printer MENU.

This feature provides:

- S easy handling of configuration (interface, etc.)
- S quick parameter changes during an application
- S a **SAVE** function to make changes permanent (until purposely reset), facilitating changes in default settings.

The menu has several levels:

- S The first level contains the Main Functions
- S Level 2 contains Sub-Functions
- S Level 3 allows to select/confirm values and contains further Sub-Functions
- S Level 4 allows to select/confirm values

For easy selection of paper source, font, pitch and macro, please refer to the Quick Settings section in this chapter.



### 2.3.1 To Activate the Menu:

S Press 

The printer is in the STOP mode, the display shows **LOCAL**

S Press  in the top row of the control panel. As soon as the menu mode has been activated, the keys in the top row can only be used as cursor keys to move within the menu tree (up, down, right, and left).

Selection within a level:

S press [i] or [\] key; the keys have a wrap around function, i.e. after the last value the first value is repeated.

On the display you will find the following four characteristic types of information:

**MENU-TEXT**      ⇒

This display is only shown if you are in the Main Function. To switch to the next level press [Y].

⇐ **MENU-TEXT**      ⇒

Now you are in a Sub-Function. Movement in both directions is possible by using the [Z] key or [Y] key.

⇐ **MENU-TEXT**      \*

In the last level, labelled **select/confirm values**, the asterisk ( ' ) to the right indicates the actual selection.

By using the [i] or [\] key, you are able to select a new value. You get the display:

⇐ **MENU-TEXT**

### 2.3.2 To Confirm Selection:

- press [Y]; the confirmed value is displayed with an asterisk ( ' ) in the last position as shown in the picture before.

**Note:** All cursor keys have an auto repeat function.

The new confirmed settings are only valid until the printer is powered off.

To save your settings permanently, see next section.

The MENU mode is left either by pressing  or by moving to the MAIN FUNCTION level and then pressing the [Z] key.







A number of VALUE settings is summarized in a "Macro". It is possible to have a total of four macros, each with a different summary of VALUE settings. The standard macros have the following emulations defined:

<b>Macro</b>	<b>Emulation</b>
1	EPSON LQ 1060, LQ 2550 (default)
2	IBM Proprinter XL 24
3	IBM Proprinter XL 24 AGM
4	EPSON LQ 1060, LQ 2550

Macro parameters can be tailored to specific application requirements. This feature is highly beneficial in case of frequent changes between applications in multi-user environment. Instead of having to adjust the menu settings each time before a particular application is starting, the user simply selects the macro containing the pre-defined set-up configurations.

### 2.3.3 How to Save Settings







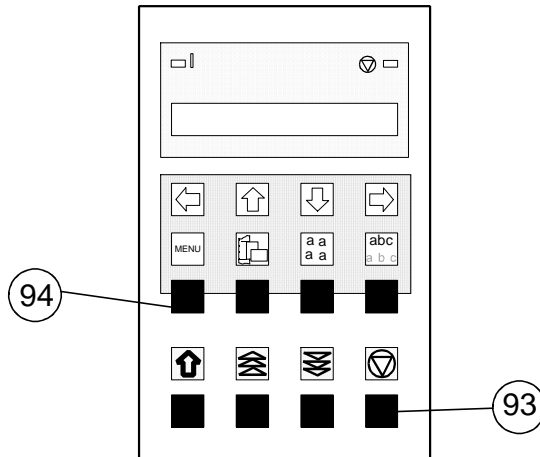

The settings selected and confirmed are only active until the printer is switched off. In order to prevent losing your new settings you can save them using the MAIN FUNCTION **SAVE**.

KEY	Display
1.  (93)	LOCAL
2.  (94)	MACRO SELECT 6
3.  -- 	SAVE 6
4. 	SAVING NOW '
5.  (93)	READY 1 ELQ

**Note:** The values of the "current settings" and the macro settings can be printed out on a list using the function **PRINT OUT**.



### 2.3.4 Quick Settings

The keys  (94) (to select a pre-configured macro),  (95),  (96), and  (97) are shortcuts in the menu tree. These particular selections can be changed quickly without having to move through the entire menu (see fold out of structure diagram). As soon as one of the keys in the top row has been activated, all four keys can only be used as cursor keys to move within the menu tree ([] up, [] down, [] right, and [] left).

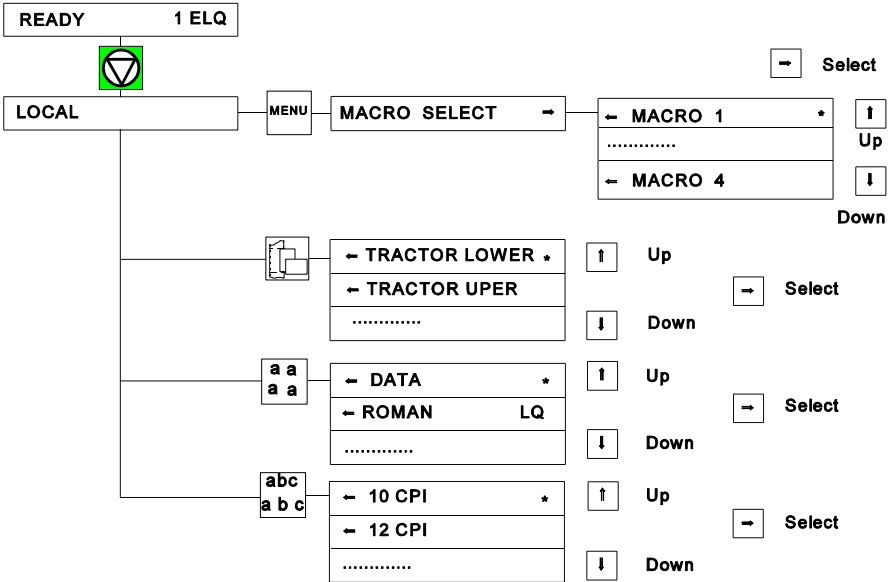

## 3 Configuring the Printer

### 3.1 What is Configuring

This chapter describes how to use the operator panel and menu settings to set up or configure your printer so that the printer and your computer system can communicate correctly with each other.

Communication between the two requires that both the computer operating system and the printer have the same communication settings or features. The most important of those are:

- S protocol
- S baud rate
- S data bits
- S interface type
- S parity





You may also need to change some of the printer's other features depending on your hardware and application requirements, for example:

- S paper handling
- S text processing.

The MENU mode allows you to access the configuration memory. All settings of the printer are stored in this memory and can be printed out on a list. The possible settings are discussed in detail in the following pages.

The menu **Print Out** illustrates the actual printer set-up. The following steps show which keys to use to start this printout.

Configuring the printer

KEY	Display
1. Switch the printer ON	READY 1 ELQ
2.  (93)	LOCAL
3.  (94)	1 SELECT 6
4. 	PRINT OUT 6
5. [Y]	7 PRINT OUT
6. [Y]	7 PRINT OUT
7.  (93)	7 PRINT OUT

After feeding paper from the defined paper source, the printer starts to print. When printing is completed, the following message will be displayed:

8.	7 PRINT OUT
9.  (93)	READY 1 ELQ

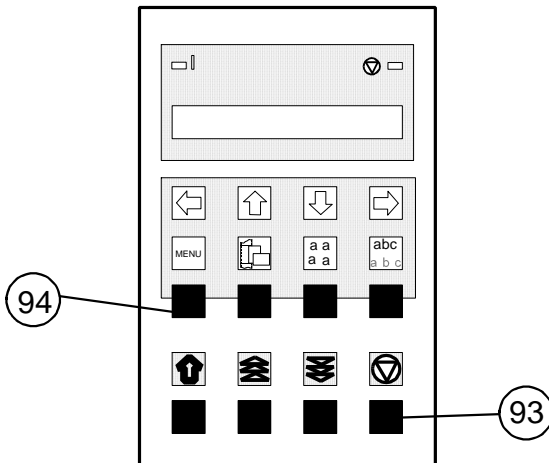

### 3.2 Standard Configuration

The standard configuration is reflected in the following printout provided that no parameters have been changed.

#### S for the CI - 4070

PRINT OUT		VERSION	208xxxxx		
INTERFACE		ADJUSTMENT			
BUFFER	8 KBYTE	AGC POSITION	24		
WORD LENGTH	8 BIT	PLATEN GAP	0		
I/F TYPE	SHARED	PAPER-IN ADJ.	0 *)		
BAUD-RATE	9600 BPS	CUT. V-POS LO.	0		
PARITY BIT	IGNORE	CUT. V-POS UP.	0		
PROTOCOL	DTR	UNI-DIRECT.COMD	YES		
		TRACT. FF-MODE	IGNORE FF		
		MENU ACCESS	ALL FUNCTIONS		
	CURRENT SETTINGS	MACRO 1*	12	MACRO 3	MACRO 4
FONT	DATA	DATA	DATA	DATA	DATA
PRINT QUALITY	LQ	LQ	LQ	LQ	LQ
GRAPHICS QUAL.	STANDARD	STANDARD	STANDARD	STANDARD	STANDARD
SUB/SUPER FONT	YES	NO	YES	YES	YES
PITCH	10 CPI	10 CPI	10 CPI	10 CPI	10 CPI
LINE	6 LPI	6 LPI	6 LPI	6 LPI	6 LPI
PAGE LENGTH	72 LINES	72 LINES	72 LINES	72 LINES	72 LINES
TRACT.L. V-POS	0	0	0	0	0
TRACT.U. V-POS	0	0	0	0	0
LEFT MARGIN	1 COLUMNS	1 COLUMNS	1 COLUMNS	1 COLUMNS	1 COLUMNS
RIGHT MARGIN	136 COLUMNS	136 COLUMNS	136 COLUMNS	136 COLUMNS	136 COLUMNS
TOP MARGIN	1 LINES	1 LINES	1 LINES	1 LINES	1 LINES
BOTTOM MARGIN	1 LINES	1 LINES	1 LINES	1 LINES	1 LINES
PERF. SKIP	YES	YES	YES	YES	YES
PAPER SOURCE	TRACTOR LOWER	TRACTOR LOWER	TRACTOR LOWER	TRACTOR LOWER	TRACTOR LOWER
EMULATION	EPSON LQ	EPSON LQ	IBM PROPR.	IBM PROPR. AGM	EPSON LQ
CHARACTER SET	EPSON EXT. GCT	EPSON EXT. GCT	IBM SET 2	IBM SET 2	EPSON EXT. GCT
	3: GERMANY	3: GERMANY	1: U.S.A.	1: U.S.A.	1: U.S.A.
LINE MODE	LF=LF, CR=CR	LF=LF, CR=CR	LF=LF, CR=CR	LF=LF, CR=CR	LF=LF, CR=CR
\$\$-COMMAND	NO	NO	NO	NO	NO
TEAR-OFF / CUT	NO	NO	NO	NO	NO

**Note:** An asterisk ( ' ) after MACRO 1 indicates the actual macro.

\*) This value is dependent on factory setting!

All this standard settings of the firmware will be restored with the menu function **RECALL FACTORY**.

## Configuring the printer

### S for the CI - 4080

PRINT OUT		VERSION		202xxxxxx	
INTERFACE		ADJUSTMENT			
BUFFER	8 KBYTE	AGC POSITION		24	
WORD LENGTH	8 BIT	PLATEN GAP		0	
I/F TYPE	SHARED	PAPER-IN ADJ.		0	*)
BAUD-RATE	9600 BPS	CUT. V-POS LO.		0	
PARITY BIT	EVEN	CUT. V-POS UP.		0	
PROTOCOL	DTR	UNI-DIRECT.CMD		YES	
		TRACT. FF-MODE		IGNORE FF	
		MENU ACCESS		ALL FUNCTIONS	
	CURRENT SETTINGS	MACRO 1*	MACRO 2	MACRO 3	MACRO 4
FONT	DATA	DATA	DATA	DATA	DATA
PRINT QUALITY	LQ	LQ	LQ	LQ	LQ
GRAPHICS QUAL.	STANDARD	STANDARD	STANDARD	STANDARD	STANDARD
SUB/SUPER FONT	YES	NO	YES	YES	YES
PITCH	10 CPI	10 CPI	10 CPI	10 CPI	10 CPI
LINE	6 LPI	6 LPI	6 LPI	6 LPI	6 LPI
PAGE LENGTH	72 LINES	72 LINES	72 LINES	72 LINES	72 LINES
TRACT.L. V-POS	0	0	0	0	0
TRACT.U. V-POS	0	0	0	0	0
LEFT MARGIN	1 COLUMNS	1 COLUMNS	1 COLUMNS	1 COLUMNS	1 COLUMNS
RIGHT MARGIN	136 COLUMNS	136 COLUMNS	136 COLUMNS	136 COLUMNS	136 COLUMNS
TOP MARGIN	1 LINES	1 LINES	1 LINES	1 LINES	1 LINES
BOTTOM MARGIN	1 LINES	1 LINES	1 LINES	1 LINES	1 LINES
PERF. SKIP	YES	YES	YES	YES	YES
PAPER SOURCE	TRACTOR LOWER	TRACTOR LOWER	TRACTOR LOWER	TRACTOR LOWER	TRACTOR LOWER
PATH	BATCH	BATCH	BATCH	BATCH	BATCH
STACK CAPACITY	-	-	-	-	-
BATCH CAPACITY	-	-	-	-	-
EMULATION	EPSON LQ	EPSON LQ	IBM PROPR.	IBM PROPR. AGM	EPSON LQ
CHARACTER SET	EPSON EXT. GCT	EPSON EXT. GCT	IBM SET 2	IBM SET 2	EPSON EXT. GCT
	3: GERMANY	3: GERMANY	1: U.S.A.	1: U.S.A.	1: U.S.A.
LINE MODE	LF=LF, CR=CR	LF=LF, CR=CR	LF=LF, CR=CR	LF=LF, CR=CR	LF=LF, CR=CR
\$\$-COMMAND	NO	NO	NO	NO	NO
TEAR-OFF / CUT	NO	NO	NO	NO	NO

**Note:** An asterisk ( ' ) after MACRO 1 indicates the actual macro.

\*) This value is dependent on factory setting!

All this standard settings of the firmware will be restored with the menu function **RECALL FACTORY**.



### 3.3 Explanation of the printout on the previous page

The heading **PRINT OUT** gives information about the **VERSION** of the printer's firmware.

The next two headings are followed by two columns of standard settings:

**S INTERFACE** - for communication between the computer operating system and the printer it is necessary to have the same communication settings or features. The standard settings are:

S Buffer	8 Kbyte
S Word Length	8 Bit
S I/F Type	Shared
S Baud Rate	9600 Bit/s
S Parity Bit	Even
S Protocol	DTR

**S ADJUSTMENT** - all parameters are for adjustment of the printer and the paper (see also the following pages).

The last part of the printout is a list with all **MACRO** settings. In this case **MACRO 1** is marked with an asterisk ( ' ) which identifies it as the active macro.

If you do not save new settings, they are lost when you turn the printer OFF and ON.

If you make modifications via the application in the active macro you will find the new settings under the heading **CURRENT SETTINGS**.

### 3.4 Explanation of Individual Menu Items

#### Main Functions

The following main functions are available:

#### S **MACRO SELECT**

To select one of the four macros which can be used for changing quickly the printer settings for different applications. For example: Application A needs 12" paper and in Application B banking checks are printed.

#### S **CHANGE MACRO**

In this part it is possible to create a macro for specific application needs (for detail information see chapter **Function CHANGE MACRO** beginning on the next page).

*Note:* Most parameters can be set via the control panel or via escape sequences from the host computer.

#### S **INSTALLATION**

In the first sub-function named **INTERFACE** you can manipulate parameters to enable communication with the host.

In the second sub-function labelled **ADJUSTMENT** you can optimize your printouts.

#### S **SAVE**

Any desired changes to the default settings can be saved here. After power ON and OFF the new settings are still activated.

While this function is executed the display flashes **SAVING NOW**.

**S PRINT OUT**

This function initiates a printout of the parameter settings and macro definitions. This printout is helpful for future reference and when macros need to be changed.

To actually start the print operation it is necessary to leave the STOP mode (by pressing the  key - see also Chapter 3.1).

While this function is executed the display shows **PRINT OUT**.

**Main Function CHANGE MACRO****S Font**

A font is a family of characters with the same style and size. The appearance of the font can be varied by using attributes such as: **SIZE**, **bold**, *italic*, etc.

The fonts included in the PM are:

- S Data
- S Roman
- S San Serif
- S Courier
- S Prestige
- S Script
- S OCR B
- S OCR A
- S Orator-C
- S Orator
- S DATA LARGE

see **Appendix B** for print samples.

**Note:** **PRINT TEST 3** lists all available fonts. The firmware of the printer indicates also barcodes. Detail information for printing barcodes are in **Appendix F Barcodes Quick Reference**.



## S Page Length

Page length is expressed in terms of lines within the range of 5 to 132 lines. Any page length setting is based on six lines per inch, regardless of the number of lines per inch selected in the line setting or defined by the application.

The following indicates the number of lines for the most common paper sizes.

Paper length in inches	Appropriate setting in no. of lines
4	24
4 $\frac{1}{6}$	25
6	36
8	48
8 $\frac{1}{2}$	51
11	66
11 $\frac{2}{3}$	70
12 (default setting)	72

The tear-off/cut mode and top/bottom margins use the page length setting as a basis.

An incorrect page length, therefore, gives an incorrect perforation skip.

## S Vertical Positioning Adjustment (VERT.POS.ADJ.)

This can be set differently for each macro to exactly position the printout in relation to the top edge of the form in use. It is meant to be a corrective parameter to meet variations in paper size and pre-printed material. Using this function, the **TOP MARGIN** and **BOTTOM MARGIN** setting are taken into account as well.

This parameter covers a range of  $- \frac{15}{60}$  to  $+ \frac{240}{60}$  of an inch, where "-" is up the page and "+" is further down the page.

The following table shows some values in inch and millimetres.

+/- 1 = +/- $\frac{1}{60}$ " = +/- 0,42 mm	+/- 9 = +/- $\frac{9}{60}$ " = +/- 3,81 mm
+/- 2 = +/- $\frac{2}{60}$ " = +/- 0,85 mm	+/- 10 = +/- $\frac{10}{60}$ " = +/- 4,23 mm
+/- 3 = +/- $\frac{3}{60}$ " = +/- 1,27 mm	+/- 11 = +/- $\frac{11}{60}$ " = +/- 4,66 mm
+/- 4 = +/- $\frac{4}{60}$ " = +/- 1,69 mm	+/- 12 = +/- $\frac{12}{60}$ " = +/- 5,08 mm
+/- 5 = +/- $\frac{5}{60}$ " = +/- 2,12 mm	+/- 13 = +/- $\frac{13}{60}$ " = +/- 5,50 mm
+/- 6 = +/- $\frac{6}{60}$ " = +/- 2,54 mm	+/- 14 = +/- $\frac{14}{60}$ " = +/- 5,93 mm
+/- 7 = +/- $\frac{7}{60}$ " = +/- 2,96 mm	+/- 15 = +/- $\frac{15}{60}$ " = +/- 6,35 mm
+/- 8 = +/- $\frac{8}{60}$ " = +/- 3,39 mm	+ 16 = + $\frac{16}{60}$ " = + 6,77 mm

**Attention:** The set up of **VERT.POS.ADJ.** will become effective at the next page of the form. Therefore, it is recommended to perform **VERT.POS.ADJ.** set up as long as the paper is in the park position and before starting the print job.

S The left margin is set in  $\frac{1}{10}$ " steps, depending on the actual selection. The first left margin position is  $\frac{1}{20}$ " from the left edge of the paper which means that the letter H in regular "Data" font would be positioned  $\frac{1}{20}$ " from the left edge of the paper. The left margin can be set to a maximum of  $\frac{15}{10}$ ".

- S **The right margin** is set to print position 80, 132 or 136, always measured from the position of the first possible, not actual, left margin setting.

The left margin setting is influenced by the physical setting of the left tractor. The above specifications are only correct if the tractors are in the original positions, i.e. the left perforation is aligned with the center mark on the plastic plate (distance between the marks is  $\frac{1}{10}$ " ).

- S **The top margin** indicates the first print line and is always set in steps of  $\frac{1}{6}$ ". The position of the first margin is  $\frac{1}{6}$ " from the top of the paper and indicates the baseline of the letter **H** in upright "Data" font (see illustration).

The top margin can be set to a maximum of  $\frac{16}{6}$ " down on the paper.

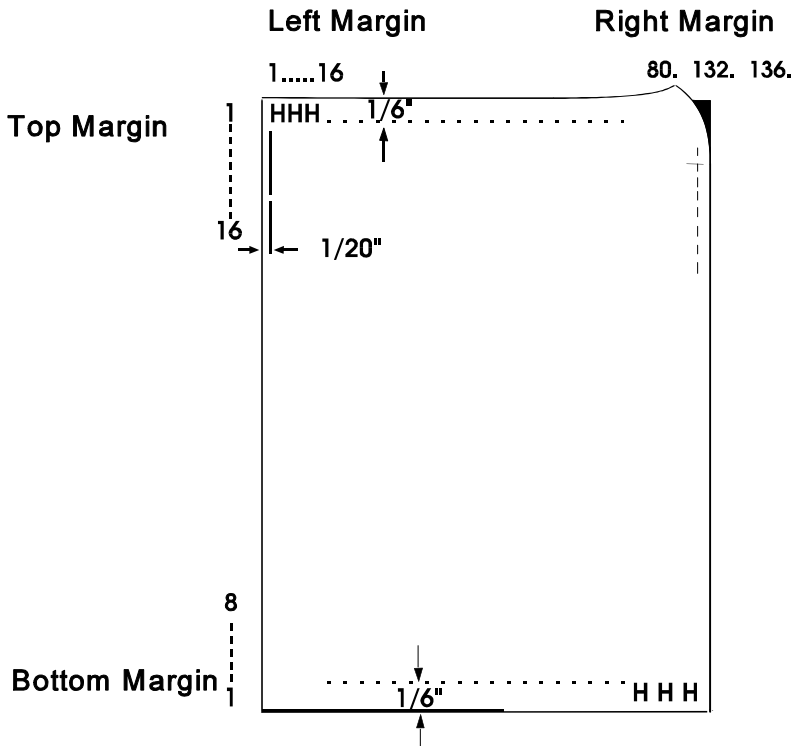

**S The bottom margin** indicates the last print line. Going beyond this margin automatically initiates a form feed. The bottom margin is always set in steps of  $\frac{1}{6}$ ".

The bottom margin can be set to a maximum of  $\frac{8}{6}$ ".

The above specifications are influenced by the settings in "Vertical Position" (see section **Vertical Positioning Adjustment** in this chapter).

### **S Perforation Skip**

If PERF. SKIP is set to **YES** the printer starts to print after specified top margin and stops printing before the bottom Margin.

If PERF. SKIP is set to **NO** the printer ignores the top and bottom margin and prints from the very first line to the very last one. That means that on a standard 11" paper 66 lines are available for printing.

### **S Paper Source**

The printer offers three input possibilities:

**S TRACTOR LOWER** (default)

**S TRACTOR UPPER**

**S TRACTOR L/U** (pool), that means that the printer switches automatically to the other cassette once the cassette in use is out of paper. The empty cassette can be loaded again and thus be ready for the next automatic switch if needed. The pool function requires the use of the same type of paper in both tractor cassettes.

**Note:** Please refer to chapter **6 Technical Data**, for detailed media specifications.



**S Paper Exit** (only for **CI - 4080**)

It is possible to choose between **BATCH** (to leave the printer at the rear) and **STACKER** (at the top) via the point **PATH**.

If **BATCH** is selected, the paper keeps its continuous form and leaves the printer at the rear. The cutter is not activated by default. If print jobs need to be separated, the cutter must be activated.

If **STACKER** is selected the fanfold paper automatically leaves the printer as cut sheets which are collected face down in the stacker at the top. The paper is cut along the perforation as long as no other form length has been defined. The form length can be determined in the menu or by the application. Printing briefly stops when the paper arrives at the cut station. The paper gets cut and is transported to the stacker. Afterwards, printing resumes.

**Note:** If, for some reason, it is not desired to print exactly on the perforation it is very important to **cut below the perforation** of the printed page. If the paper is cut above the perforation the remaining paper can easily bend and cause a paper jam. Do not cut through a label as the blade would get dirty by the glue.

**S STACK.CAPACITY** (capacity at the top)  
(only for the **CI - 4080**)

**S BATCH CAPACITY** (capacity of the option at **Cut Sheet Tray** at the rear)  
(only for the **CI - 4080**)

To control the capacity of the Stacker or the Cut Sheet Tray use these two functions. Capacity can be defined in steps of 20 single sheets.

**S STACK.CAPACITY** in the range from 20 to 200 and

**S BATCH CAPACITY** from 20 to 600 sheets. (single sheet paper, see chapter **6 Technical Data, paper specification**)





**Change of Paper Exit** (only for the **CI - 4080**)

When switching from one paper exit to the other, paper in the printer moves automatically to the cut station where it is cut at the perforation below the last printed page.

## S Emulation

The emulation determines the set of commands available for the printer (see **Appendix D** and **E**).

- S **EPSON LQ**
- S **IBM PROPR.**
- S **IBM PROPR.AGM**
- S **EPSON LQ**

**Note:** The selected Emulation will also be stored in the actual macro. With a change of the macro (e.g. key , ,  or  is pressed) it is possible that the emulation will also be changed. Be careful: Do not change the emulation within an application.

## S Character Set

When selecting a character set it can be further specified by the corresponding national versions.

Detailed tables of the character sets can be found in **Appendix B**.

- If a different macro is selected the default character set may change,
- e.g. - **IBM PROPR.** emulation has the character set **IBM SET 2** as default.
  - **EPSON** emulation has the character set **EPSON EXT.GCT** as default.

## S Line Mode

If LF = LF + CR is selected, the printer performs a carriage return (CR) for every line feed (LF) received via the interface.

If CR = LF + CR is selected, the printer performs a line feed (LF) for every carriage return (CR) received via the interface.

## S \$\$ Commands

This function causes \$\$ either to be printed as \$\$ or to activate ESC commands within an application.

If this function is set to **YES** the characters are interpreted by the printer in the following way:

- S **\$\$** as **ESC [**
- S **\$\$/** as **ESC.**

### S Tear-off-mode / Cut-mode

In case the selection of paper exit for the **CI - 4080** is "STACKER", each form will be cut automatically and laid down into the stacker.

If for the **CI - 4080** "BATCH" is selected or the **CI - 4070** is in use, the following choices of either automatic feeding into the tear off position or automatic cutting are available:

S	<b>NO</b>	
S	<b>TEAR - OFF 10 S</b>	
S	<b>TEAR - OFF 1 S</b>	
S	<b>CUT 10 S</b>	only for <b>CI - 4080</b>
S	<b>CUT 1 S</b>	only for <b>CI - 4080</b>
S	<b>CUT 1 S NO FF</b>	only for <b>CI - 4080</b>
S	<b>CUT MODE ON</b>	only for <b>CI - 4080</b>

Disregarding these settings for the **CI - 4080**, the printer will always cut the paper when a switch from one tractor to the other has been initiated. In this case the **CI - 4070** gives the message **TEAR OFF** Furthermore, all settings can be overruled by software (Command SPSIF, cut mode on).

**Note:** If in the **CI - 4080** the page before the last gets cut it is not possible to print on the very last page of the fanfold batch because it has left the transport pins of the tractors.

The setting **NO** means, that neither automatic feeding into the tear off position nor automatic cutting is performed. It is appropriate for batch output of continuous forms.

The setting **TEAR - OFF 10 S** causes the paper to move into the tear off position if no new printing data have been received within 10 seconds. This setting supports applications lacking a programmed form feed after the completion of a print job. If printing data are received for the page at the tear off position after 10 seconds the page is moved back so that printing can resume at the last print position. If the page has already been torn off printing will be continued at the top of the next page.

The setting **TEAR - OFF 1 S** causes the paper to move to the tear off position when the print job has been completed by a form feed command and no new print job has been received within one second. If the paper is not torn off and new printing data are received the paper moves back into the printer to allow the following page to be printed.

The setting **CUT 10 S (CI - 4080)** causes the form to be cut if no further printing data have been received within a print job for a period of 10 seconds. After cutting, the paper moves immediately into the top of form position of the next page. This setting supports applications lacking a programmed form feed after completion of a print job.

The setting **CUT 1 S (CI - 4080)** causes the form to be cut if, after a **form feed command**, no further printing data have been received within a print job for a period of 1 second. After cutting, the paper moves immediately into the top of form position of the next page.

The setting **CUT 1 S NO FF (CI - 4080)** has the same function as **CUT 1 S** but is **independent of receiving of a form feed command**.

By the function **CUT MODE ON** and **PATH = BATCH** in **PAPER EXIT** the **CI - 4080** will cut continuous forms into single sheets and feed them to the rear. Use the optional Cut Sheet Tray to collect the sheets. The application has to control page length. The page length must be at least three inch, otherwise the printer is unable to through out the sheet.

## Main-Function INSTALLATION

### S Sub-Function INTERFACE

The factory settings for the interface type are: **Shared, 8 Kbyte Buffer, 8 bit word length, even parity bit, 9600 baud, and DTR protocol.**

### S BUFFER

Buffer size in Kbyte. The maximum size is 30 Kbyte.

### S WORD LENGTH

Length of the data to be transferred; values are 7 or 8 bit.

### S I/F TYPE (Interface Type)

the following types are available:

#### S Parallel

#### S Serial

#### S Shared

In case the **SHARED** interface type is selected the printer switches automatically between the parallel and serial interface. The first data received at the port determine which interface port becomes active. The other interface port will be closed so that only one interface is active at a time (for detailed information see **Appendix A Interface Description**).

### S BAUD RATE (only indicated if the serial interface is selected)

Controls the speed of data transfer. The possible transfer rates are: 600, 1200, 2400, 4800, 9600 or 19200 bps.

### S PARITY BIT (only indicated if the serial interface is selected)

The data transfer will be checked by an even or odd parity bit. The values are: **EVEN, ODD, NONE** or **IGNORE**.

### S PROTOCOL (only indicated if the serial interface is selected)

Selectable are: **DTR, XON/XOFF**, or **XON/XOFF + DTR**.

## Sub-Function ADJUSTMENT

### S AGC Position

AGC (**A**utomatic **G**ap **C**ontrol) is an integral part of the paper handling capabilities of the printer. It is an automatic adjustment function which ensures an optimal print quality when using paper of various thicknesses.

The gap adjustment will automatically take place whenever paper is inserted

S after the paper source has been changed

S from park position

S after Power On

S after the printer has been in the STOP mode

S an AGC command has been issued.

The reference point for the measurement of the paper thickness is the **AGC Position** of the first print line. Default for the horizontal AGC Position is 24 (= ink ribbon exchange position), any position from 4 to 131 in steps of 10 cpi can be selected.

An adjustment of the AGC Position is only necessary if a measurement at the default position does not reflect the paper thickness of the area to be printed on or if there is a paper edge (e.g. of a label) in that position (the measuring process requires a plain paper-surface).

In addition to the automatic AGC function, measurements of the paper thickness at various positions can be executed by the AGC command, or a specific platen gap can be set using the PCC command. This is to meet the requirements of forms with complex properties. For details see Appendix **D** and **E** Quick Reference.

**S Platen Gap**

This adjustment is to be seen as a correctional offset to the platen gap set by the **AGC** (Automatic Gap Control) function or a **PCC** (Programmable Copy Control) command. It effects all paper paths.

The offset is within the range of **-3** to **+4**. One step is equal to 18 µm. "-" reduces the gap, "+" increases it.

**Note:** This setting should only be changed in exceptional case. The optimum setting of the platen gap will be done automatically by the **AGC** or **PCC**

**S AGC Adjust**

This is a basic adjustment which is automatically performed at the initial Power On of the printer, and which thereafter only needs to be initiated after having exchanged the print head or the platen. It is essential that the ink ribbon is installed and **no paper** is in the printer when this procedure is started. After activating this procedure, the printer displays **INSTALL RIBBON**. If the ribbon is installed press  to continue.

**S PAPER-IN ADJ** (Paper-In-Sensor adjustment)

This parameter logically adjusts the base position of the Run-In-Sensor. The factory set value is such that the default is set to compensate specific mechanical tolerances. The adjustment range is from **-3** to **+4** in  $\frac{1}{60}$ " steps (0.42 mm), where "-" means an upward movement and "+" a downward movement. When implemented, the adjustment applies to all paper paths.

**S CUT. V-POS LO. / CUT. V-POS UP.** (Vertical Positioning for Cutting Device for the **CI - 4080** or for the tear off edge on the **CI - 4070**)

This can be set differently for each paper source (lower and upper tractor) and is meant to be a corrective parameter to meet variations in paper size and pre-printed material.

The parameter covers a range of  $- \frac{15}{60}$ " to  $+ \frac{16}{60}$ " of an inch, where "-" is up the page and "+" is further down the page. The default value is zero.

**Note:** If, for some reason, it is not desired to cut exactly on the perforation it is very important to **cut below the perforation** of the printed page. If the paper is cut above the perforation the remaining paper can easily bend and cause a paper jam. Do not cut through a label as the blade would get dirty by the glue.

The following table shows the possible values in inch and millimetres.

+/- 1 = +/- $\frac{1}{60}$ " = +/- 0,42 mm	+/-9 = +/- $\frac{9}{60}$ " = +/- 3,81 mm
+/- 2 = +/- $\frac{2}{60}$ " = +/- 0,85 mm	+/- 10 = +/- $\frac{10}{60}$ " = +/- 4,23 mm
+/- 3 = +/- $\frac{3}{60}$ " = +/- 1,27 mm	+/- 11 = +/- $\frac{11}{60}$ " = +/- 4,66 mm
+/- 4 = +/- $\frac{4}{60}$ " = +/- 1,69 mm	+/- 12 = +/- $\frac{12}{60}$ " = +/- 5,08 mm
+/- 5 = +/- $\frac{5}{60}$ " = +/- 2,12 mm	+/- 13 = +/- $\frac{13}{60}$ " = +/- 5,50 mm
+/- 6 = +/- $\frac{6}{60}$ " = +/- 2,54 mm	+/- 14 = +/- $\frac{14}{60}$ " = +/- 5,93 mm
+/- 7 = +/- $\frac{7}{60}$ " = +/- 2,96 mm	+/- 15 = +/- $\frac{15}{60}$ " = +/- 6,35 mm
+/- 8 = +/- $\frac{8}{60}$ " = +/- 3,39 mm	+ 16 = + $\frac{16}{60}$ " = + 6,77 mm



**S Uni-Direct.CMD**

If **NO** is selected, commands for uni-directional printing will be ignored. The default setting of **YES** means that commands will be carried out to switch from bi-directional to uni-directional or vice versa.

**S TRACT. FF-MODE** (Tractor Form Feed Mode)

**EXECUTE FF** means, every form feed sent to the printer will be executed.

If you set **IGNORE FF**, only a form feed before printable characters will be executed, that means blank pages will be avoided.

**Special Sub-Items under INSTALLATION**

**S Language**

The operator panel may display its messages in three languages. Select one out of the following: **ENGLISH, DEUTSCH, FRANCAIS.**

**S RESTORE SET UP**





With this function all settings of the last **SAVE** procedure will be restored.

**S RECALL FACTORY**

All standard settings of the firmware will be restored. The contents of Page Counter and the Paper-in Adjust will not be changed. Use the function **SAVE** if the standard settings shall be active after power off/on.

## S Menu Access

There are four possibilities to define the access to the menu by the user.

- S **ALL FUNCTIONS** All functions can be used (default)
- S **QUICK SET. OFF** With this function the Quick Settings for Macro Selection, Vertical Position Adjustment, and Fanfold Displacement can be deactivated in the **READY** or **BUSY** mode. After pressing one of these keys the display shows shortly **LOCKED** (see also Chapter 2).
- S **MACROS ONLY**
- Macros can be selected using the Quick Macro Selection keys  ,  ,  and  .
  - The Vertical Positioning Adjustment Mode can be entered
  - The Fanfold Displacement Mode can be entered.
- S **NO ACCESS** The menu is not accessible at all.

The menu function **PRINT OUT** can be activated regardless of the defined menu access.

**Note:** Only the system manager is able to reset the functions **MACROS ONLY** and **NO ACCESS**.

**S Self Test**

**S PRINT TEST 1** (see Chapter 1.8 Print Tests)

**S PRINT TEST 2** (see Chapter 1.8 Print Tests)

**S PRINT TEST 3** gives information about technical releases and is intended for service purposes only. Among other information, the page counter identifies the number of pages printed.

**S I/F Test** This function is used to test the serial interface. It enables test data to be sent out from the printer and returned by means of a closed loop connector plugged into the serial interface connector. The test data uses consist of **PRINT TEST 1**.

**S Hex Dump**

This function makes it possible that the data received by the printer can be analyzed. Control codes are no longer carried out, instead all data is printed in hexadecimal format and as ASCII characters. Any non-printable characters, such as carriage return are only represented as a single dot (.) in the ASCII list.

It may happen that the transmission of data to the printer will be interrupted during Hex Dump. In this case, printing of data received after the break is started on the next available line. The result is an irregular right margin which is not an indicator for any loss of data.



```

*
*
* [7 PAPER EXIT 6] ))) [7 PATH *] ))) [7 BATCH *]
* * (only CI - 4080) * * [7 STACKER ]
* * * * *
* * [7 STACK.CAPACITY ] ))) [7 STACK.CAP. - *]
* * (Range: -, 20 to 200, step 20) * *
* * * * *
* * [7 BATCH CAPACITY ] ))) [7 BATCH CAP. - *]
* * (Range: -, 20 to 600, step 20) * *
* * * * *
* [7 EMULATION 6] ))) [7 EPSON LQ *] (Macro 1)
* * [7 IBM PROPR. ] (Macro 2)
* * [7 IBM PROPR. AGM ] (Macro 3)
* * [7 EPSON LQ ] (Macro 4)
* * * * *
* [7 CHARACTER SET 6] ))) [7 EPSON EXT. GCT 6] ))) [7 1: U.S.A. *]
* * * * * [7 2: FRANCE ]
* * (Macro 1 = GERMANY) * * [7 3: GERMANY *]
* * (Macro 4 = U.S.A.) * * [7 4: U.K. ]
* * * * * [7 5: DENMARK ]
* * * * * [7 6: SWEDEN ]
* * * * * [7 7: ITALY ]
* * * * * [7 8: SPAIN ]
* * * * * [7 9: JAPAN ]
* * * * * [7 10: NORWAY ]
* * * * * [7 11: DENMARK 2 ]
* * * * * [7 12: SPAIN 2 ]
* * * * * [7 13: LATIN AM. ]
* * * * * [7 14: TURKEY ]
* * * * * [7 15: LEGAL ]
* * * * *
* * [7CODE PAGE EE 6] ))) [7 1: CP 437 GK *]
* * * * * [7 2: CP 851 GK ]
* * * * * [7 3: CP 928 GK ]
* * * * * [7 4: CP 855 CYRI ]
* * * * * [7 5: CP 866 ]
* * * * * [7 6: CP 869 ]
* * * * * [7 7: CP 852 ]
* * * * * [7 8: KAMENICKY ]
* * * * * [7 9: ISO LATIN 2 ]
* * * * * [7 10: MAZOVIA ]
* * * * * [7 11: CP 437 HUN ]
* * * * * [7 12: CP 852 SEE ]
* * * * * [7 13: CP 866 LAT ]
* * * * * [7 14: WIN LAT 2 ]
* * * * *
* * [7CODE PAGE EE2 6] ))) [7 1: CP 771 *]
* * * * * [7 2: CP 773 ]
* * * * * [7 3: CP 774 ]
* * * * * [7 4: CP 775 ]
* * * * * [7 5: BALTIC RIM ]
* * * * *
* * [7 IBM SET 1 6]
* * [7 IBM SET 2 6] ))) [7 1: U.S.A. *]
* * * (Macro 2, 3) * * [7 2: FRANCE ]
* * * * * [7 3: GERMANY ]
* * * * * [7 4: U.K. ]
* * * * * [7 5: DENMARK ]
* * * * * [7 6: SWEDEN ]
* * * * * [7 7: ITALY ]
* * * * * [7 8: SPAIN ]
* * * * * [7 9: JAPAN ]
* * * * * [7 10: NORWAY ]
* * * * * [7 11: DENMARK 2 ]
* * * * * [7 12: SPAIN 2 ]
* * * * * [7 13: LATIN AM. ]
* * * * * [7 14: TURKEY ]
* * * * *
* * [ *
* * [7 IBM CODE PAGE 6] ))) [7 1: PAGE 437 *]
* * * * * [7 2: PAGE 850 ]
* * * * * [7 3: PAGE 860 ]
* * * * * [7 4: PAGE 863 ]
* * * * * [7 5: PAGE 865 ]
* * * * * [7 6: PAGE 858 ]
* * * * *
*

```



```
*
*
* [7 LANGUAGE 6] ))) [7 ENGLISH *]
* [7 DEUTSCH ]
* [7 FRANCAIS ]
*
*
* [7 RESTORE SET UP 6] ))) [7 NO *]
* [7 YES ]
*
*
* [7 RECALL FACTORY 6] ))) [7 NO *]
* [7 YES ]
*
*
* [7 MENU ACCESS 6] ))) [7 ALL FUNCTIONS *]
* [7 QUICK SET OFF ]
* [7 MACROS ONLY ]
* [7 NO ACCESS ]
*
*
* [7 SELF TEST 6] ))) [7 PRINT TEST 1 ]
* [7 PRINT TEST 2 ]
* [7 PRINT TEST 3 ]
* [ ] (only Serial Interface)
*
* [7 HEX DUMP 6] ))) [7 HEX DUMP ]
*
*
[SAVE \ 6] ))) [7 SAVING NOW ]
*
[PRINT OUT 6] ))) [7 PRINT OUT ]
```

## 4. Maintenance

### Preferred Materials

The following materials and cleaning lubricants are recommended for use in the maintenance procedure:

S Lint-free cloth

S Platen Cleaner C/CP09, commercial no: 8709 004 10931

S Vacuum cleaner.

### 4.1 Cleaning the Platen and Surrounding Areas

The user should clean the printer every six months or after 50,000 prints, whichever occurs first. If you experience paper feed problems, or if the print head carriage movement becomes restricted, cleaning should be carried out more often.

**Note:** The Page Counter (**PGCNT**) in the **PRINT-TEST 3** will inform you about the actual number of printed pages.



### PRINT TEST 3

#### CONFIGURATION

PM1 208xxxxx	PM2 00000000	PM3 208xxxxx	PBC 20807222
SPC 20000000	CUR 4	PMR 0	
NFQ 2100	DSF 100	NLSF 100	LSF 100
GSF 100	NFT 260	TNA1 230	TNA2 230
TNA3 260	AC 6.00	PSL 44	PGC 20
<u>PGCNT 3333</u>	SBP 38		

C061 IBM SET 1	C062 IBM SET 2	C063 IBM CODE PAGE
C071 EPSON EXT. GCT	C100 CODE PAGE EE	C101 CODE PAGE EE2
C091 BARCODE		

DATA	ROMAN	NLQ	ROMAN	LQ
SAN SERIF	NLQ SAN SERIF	LQ	COURIER	NLQ
COURIER	LQ PRESTIGE	NLQ	PRESTIGE	LQ
SCRIPT	NLQ SCRIPT	LQ	OCR B	LQ
OCR A	LQ ORATOR-C	NLQ	ORATOR-C	LQ
ORATOR	NLQ ORATOR	LQ	DATA LARGE	

CHARACTER SET : EPSON EXT. GCT 3: GERMANY

AGC TEST AGC TEST AGC TEST AGC TESTAGC TEST



#### PRINTHEAD NEEDLE

1 2 3 4 5 6 7 8 9 10 11 12 13 14 15 16 17 18 19 20 21 22 23 24



#### DATA

! "# \$ % & ' ( ) \* + , - . / 0 1 2 3 4 5 6 7 8 9 0 ; : < = > ? . . . . .  
.  
.

**Note:** The number following **PM1** identifies the micro program and the number following **PM3** identifies the character set.

## 4.2 Cleaning Procedure

1. Power the printer ON and remove the top cover.
2. Remove the ribbon cassette.
3. Thoroughly brush and vacuum all accessible areas to remove any paper flock and dust.
4. Clean the platen's surface, the paper pressure rollers and the transport rollers using the platen cleaner. In order to access the transport rollers loosen the green screws and remove the metal bar with the metal rollers.
5. Clean the covers and the operator panel with a damp, lint-free cloth. Do not use cleaning solvents or excessive amounts of water.
6. Insert the ribbon cassette (see Chapter **1.5 Installing the Ribbon Cassette**).
7. Remount the top cover.

**Note:** (for **CI - 4080**) Cutting through a sticky label leaves glue on the blade, leading to problems with the cutting device. Small parts of a cut through label could detach from its paper and get stuck under the shield of the print head or even block the cutter completely. If the shield or the blade gets dirty it must be cleaned immediately. Use a cloth with petrol.  
Caution: There is danger to get hurt.

### 4.3 User Replaceable Parts

#### 4.3.1. Replacement of the Print Head

The print head has an expected life time of approximately 350,000 pages (see Page Counter (PGCNT) in **PRINT TEST 3** on page before).

#### Print Head Removal

**Caution:** The print head may be very hot immediately after printing.

1. Switch the printer ON, lift and remove the top cover. The print head will move to the correct position, aligned with the cut-out in the paper guide plate.
2. Remove the ribbon cassette
3. Switch the printer OFF
4. Swing the cutter housing (10) to the rear (only for **CI - 4080**)
5. Disconnect the print head cable (4)
6. Using the supplied tool (7), loosen the two captive screws (6) retaining the print head (5). Use the enclosed plastic case as an extension for the socket head cap key.
7. Remove the print head (5)

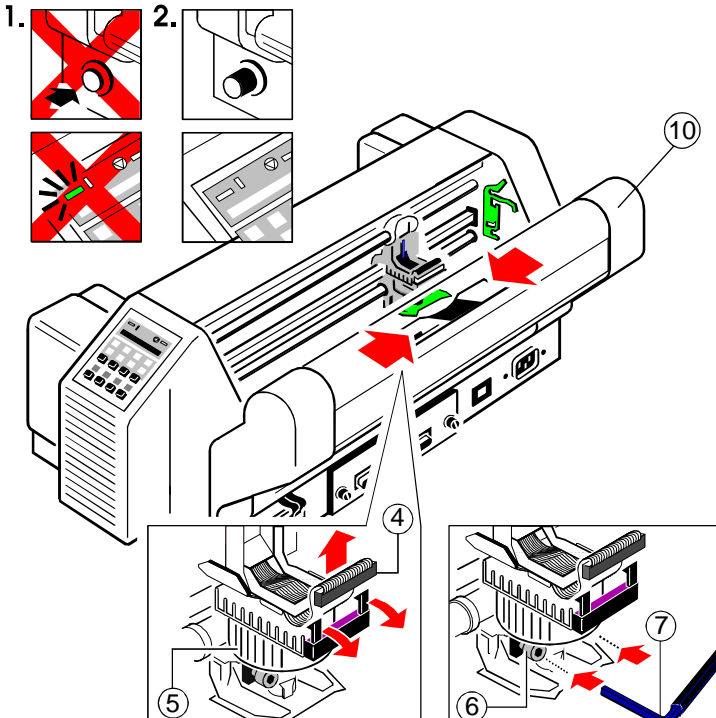

## 5 Print Head Installation

Ensure that the printer is switched OFF. For print head installation, the carriage should be aligned with the cut-out in the paper guide plate (same position as for removal procedure).

1. Hold the print head (5) in its mounting position and press it against its stop in direction of the platen. The two noses (9) of the adjustment guide (8) support this procedure.
2. Fasten the captive screws (6):
  - S fasten the screw to its stop
  - S tighten the left screw
  - S put the enclosed plastic case onto the socket head cap key and first tighten the right and then the left screw.
3. Reconnect the print head cable (4) and fasten it
4. Refit the cutter (10), mount and close the top cover (only for **CI - 4080**)
5. Switch the printer ON, open the top cover after the message "READY", and insert the ink ribbon cassette
6. Run the MENU function **AGC ADJUST** with ribbon cassette installed but without any paper inserted in the printer

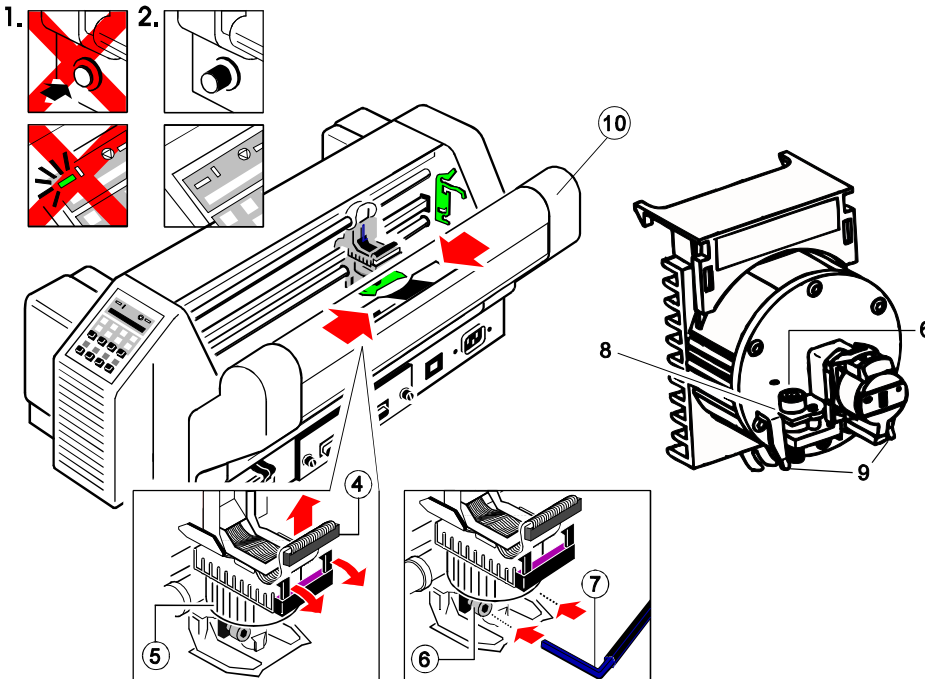

### 4.3.2 Replacement of the Platen

The platen needs to be replaced after approximately 350,000 pages (see Page Counter (PGCNT) in **PRINT TEST 3**).

#### To Remove the Platen

1. Switch the printer OFF.
2. Lift and remove the top cover
3. Swing back the cutter housing (only for **CI - 4080**)
4. Remove the ribbon cassette
5. Position the print head to the very right
6. Release the green plastic platen clamp (61) on the left platen mounting
7. Move the platen (60) approximately 0,4 inch to the left, lift the left end of the platen free of its mounting and withdraw the platen from the right mounting.
8. Lift the platen to the left underneath the print head and take it out

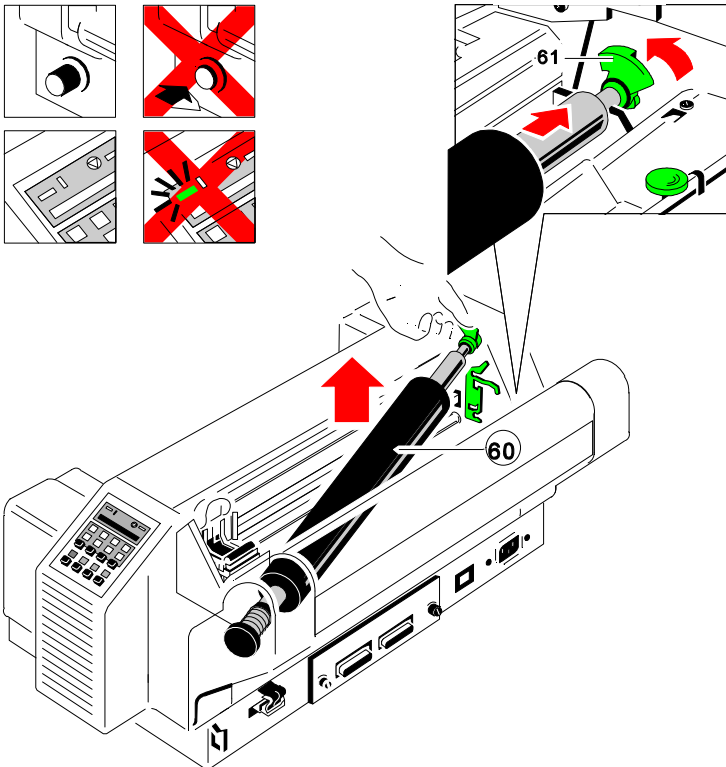

## To install the Platen

Ensure that the printer is switched OFF.

1. Place the platen (60) in the space between print head and metal bar
2. Move the print head from its position at the right into the center
3. Fit the gear wheel at the end of the platen into the right mounting. Be careful not to damage the gear wheel
4. Ensure that the plastic platen clamp (61) is in an upright position, push the platen into its mounting and lock it by pushing the tag on the clamp to the rear
5. Install the ribbon cassette
6. Swing back the cutter housing (only for **CI - 4080**)
7. Reapply and close the top cover
8. Run the MENU function **AGC ADJUST** without any paper inserted into the printer

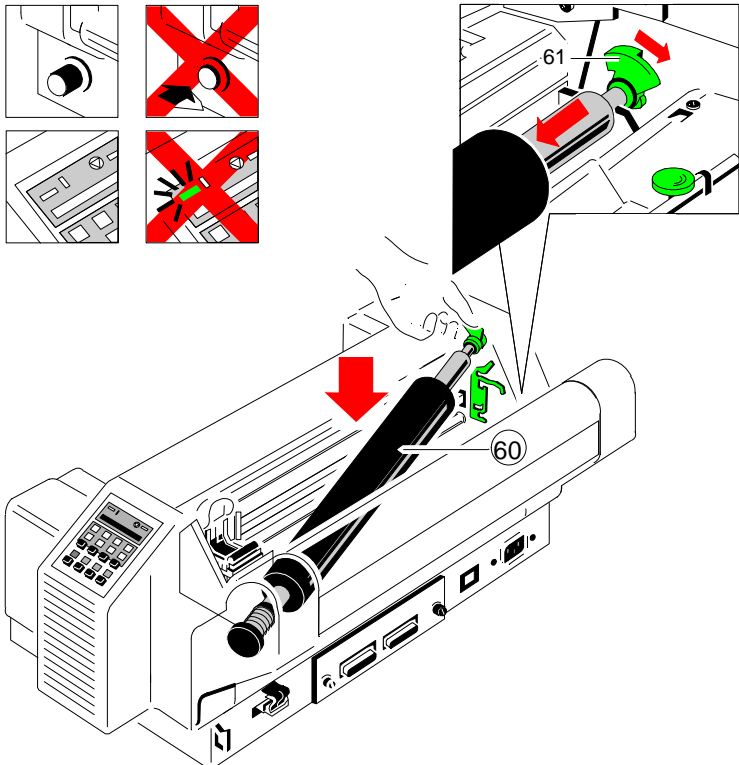

## 5. Trouble Shooting and Diagnostics

### How to Use This Section

1. Find the category to which your problem belongs. The problem categories are:
  - S Power-related Problems
  - S Error Messages
  - S No Printout
  - S Operation-related Problems
  - S Print-related Problems
  - S Paper Jam
  - S Ribbon or Carriage-related Problems

For example, if the print appears very light on the paper, look at Section Print-related Problems.

2. Find the symptom description that most closely matches the printer symptom. In this example you would look at the symptom "Print faint or of poor quality."
3. Try the first suggestion under that heading.
4. If the suggestion does not cure the problem, try the next suggestion.
5. If none of the suggestions enable you to continue printing, or if the fault is not listed, contact your service.

Each time the printer is switched ON the display indicates TEST while the internal self-tests are run. If the test is completed successfully **READY 1 ELQ** will be displayed. If an error message is displayed please refer to the following section.

## 5.1 Power-related Problems

- S Power indicator does not come On when power is switched On
- S Check that the power cord and plug are securely fitted to the printer and to an electrical outlet.
- S Ask for the power connector connections (and fuse, if fitted) to be verified.
- S Ask for the building electrical supply to be verified.

## 5.2 Error Messages

After switching the power ON the printer runs a self test. During the test the following messages may be shown on the display:

Display	That means...	Cause
No information, POWER ON indicator not lit.	No power	S Mains cable not connected
green and yellow LED give light but no reaction	hang up in reset after power on	S Print PSU defective S Print CU-DEV defective
#####	Firmware does not work	S PM not inserted S PM not correctly inserted S no firmware on PM S PROMs not correctly installed
TEST.... (flashing)	Initializing of the EEPROM	S After first POWER ON with PM S Change of PM S Contents of the EEPROM faulty
I/O OK	EEPROM located on the Control Unit not addressable	EEPROM S not installed S not correctly installed S defective





<b>Display</b>	<b>That means....</b>	<b>Cause</b>
<b>NV RAM OK</b>	Error on the RAM of the Control Unit	S Control Unit defective
<b>RAM OK</b>	Checksum error (P)ROM 1	S (P)ROM defective
<b>ROM 1 OK</b>	No Fonts available	S Character generator P(ROM) on PM damaged or missing
<b>MC OK</b>	Fault on Control Unit	S Control Unit defective S Type mismatch of PM and Control Unit S PBC (Printer Base Controller) on Control Unit damaged S SPC (Speed Controller) on Control Unit damaged



If all tests have been passed successfully the following message will be displayed:

<b>READY 1 ELQ / BUSY 1 ELQ</b>	The Printer is OK	S Printer ready for operation
-------------------------------------	-------------------	-------------------------------

During normal operation the following error messages may occur.:

Display	That means...	Cause / Action
<b>AGC ERROR</b>	AGC ADJUST procedure fault	<ul style="list-style-type: none"> <li>S Distance print head and platen faulty</li> <li>S Print head loose</li> <li>S Platen incorrectly installed</li> <li>S Ribbon not inserted</li> <li>S Horizontal drive without function</li> <li>S Platen got dirty</li> </ul>
<b>BUFFER OVERFLOW</b>	Handshake protocol error	<ul style="list-style-type: none"> <li>S Check CTR - CTS or XON - XOFF protocol</li> <li>S Repeat data transfer</li> </ul>
<b>COVER OPEN</b>	Displayed when the top cover is open and the printer is in the <b>READY</b> or <b>BUSY</b> mode.	<ul style="list-style-type: none"> <li>S Close cover</li> </ul>
<b>CUTTER ERROR</b>	Cutter without any function (only for <b>CI - 4080</b> )	<ul style="list-style-type: none"> <li>S Cutter not connected</li> <li>S Connector loose</li> <li>S Blade locked</li> <li>S Cutter defective</li> </ul>
<b>ELECTR-FAN ERROR</b>	Fan defective	<ul style="list-style-type: none"> <li>S Call service</li> </ul>
<b>FRAMING ERROR</b>	Protocol error	<ul style="list-style-type: none"> <li>S Check protocol setting of printer and host</li> <li>S Repeat data transfer</li> </ul>

Display	That means...	Cause / Action
<b>HOR. DRIVE ERROR</b>	Horizontal drive without function	<ul style="list-style-type: none"> <li>S Horizontal drive blocked</li> <li>S Paper jam</li> <li>S Distance of platen gap too narrow</li> <li>S AGC procedure on not workable position</li> <li>S Platen incorrectly installed</li> <li>S No AGC ADJUST after print head or platen replacement</li> <li>S Device electronic fault</li> <li>S Encoder strip missing</li> <li>S Horizontal drive fault</li> </ul>
<b>LOAD TRACTOR UPPER or LOWER</b>	Displayed when the host sends a form feed or print command to an empty tractor cassette. The printer enters the STOP mode.	<ul style="list-style-type: none"> <li>S Load paper and press  .</li> </ul>
<b>LOCAL</b>	Entered when  was pressed. The STOP indicator is lit.	<ul style="list-style-type: none"> <li>S Press  to continue.</li> </ul>
<b>PAPER JAM TRF</b>	Displayed if line feeds fail to move fanfold paper correctly.	<ul style="list-style-type: none"> <li>S Please refer to paragraph 5.4 for suggestions how to remove a paper jam.</li> </ul>

Display	That means...	Cause / Action
<b>HOR. DRIVE ERROR</b>	Horizontal drive without function	<ul style="list-style-type: none"> <li>S Horizontal drive blocked</li> <li>S Paper jam</li> <li>S Distance of platen gap too narrow</li> <li>S AGC procedure on not workable position</li> <li>S Platen incorrectly installed</li> <li>S No AGC ADJUST after print head or platen replacement</li> <li>S Device electronic fault</li> <li>S Encoder strip missing</li> <li>S Horizontal drive fault</li> </ul>
<b>LOAD TRACTOR UPPER or LOWER</b>	Displayed when the host sends a form feed or print command to an empty tractor cassette. The printer enters the STOP mode.	S Load paper and press  .
<b>LOCAL</b>	Entered when  was pressed. The STOP indicator is lit.	S Press  to continue.
<b>MOTOR-FAN ERROR</b>	Fan defective	S Call service
<b>PAPER JAM TRF</b>	Displayed if line feeds fail to move fanfold paper correctly.	S Please refer to paragraph 5.4 for suggestions how to remove a paper jam.

Display	That means...	Cause / Action
<b>PARITY ERROR</b>	Protocol error	S Check protocol setting of printer and host S Repeat data transfer
<b>TEAR OFF PAPER</b>	This message is displayed when the menu selection is <b>TEAR OFF</b> and the printer moved paper into the tear off position. Operator must "tear off" the fanfold paper along the back edge of the printer (paper should be torn off from left to right).	S Press  to enable the fanfold paper to be fed backwards to a park position so that the newly selected paper source can be used.
<b>TEMP.SENSOR ERR</b>	Temperature sense defective	S Call service

### 5.3 No Printout

#### S **Self-test printout does not start**

- S Make sure that you have closed the cover.
- S Check if paper is loaded in the printer.
- S Refer to section **1.8 Test Prints**.

#### S **Printing does not start**

- S Make sure that the **READY** or **BUSY** message is displayed. If there is a different message displayed please refer to the above error message table.
- S Make sure that the printer is connected to the host computer. (Refer to section **1.9 Connection to a Computer**). Make sure that connectors are properly fixed at both ends.
- S Make sure that the printer is receiving data from the host computer.
- S Make sure that the correct protocol is enabled. (Refer to section **3.2 Standard Configuration** and Appendix **A Interface Description**)
- S Make sure that you have selected the correct port (if the automatic feature has not been selected).
- S Make sure that paper is loaded.
- S Make sure that the ribbon is installed.
- S Examine the ribbon path. Does the ribbon pass in front of the whole printhead? Adjust the ribbon if necessary.

#### S **Fanfold paper in lower or upper tractor does not advance**

- S Make sure that the right tractor is selected.

## 5.4 Operation-related Problems



### S **Paper is not positioned at perforation for tear-off**

- S Select the correct form length using the Set-up feature.
- S Reset top of form by performing a Parking function.
- S Refer to section **3.4 Vertical Positioning Adjustment**

### S **Paper tears or jams**

- S Examine the paper path; remove any obstructions
- S Is the paper too loose or too taut between the tractors?
  - If the holes in the paper are deformed at their outer edges, the paper is too taut.
  - If the paper rises between the tractors, it is too loose.
  - Readjust the tractor spacing so that the paper lies smoothly but without any tension.
  - Ensure that the paper is horizontally aligned on the pins.
- S Open the printer's top cover. If necessary, loosen the two green screws and remove the paper guide plate to gain access to the paper.

### S **Parking paper and resetting top of form**

- S Tear off the paper at the perforation line.
- S Press  .
- S Press  until the paper is in the park position.
- S Press  . Printing will resume at the top of the next form.

### S **Print head carriage does not move smoothly/does not move at all**

- S Examine the paper path. Remove any obstructions.
- S Examine the carriage area for obstructions. Remove, where necessary. Press the  key when the paper path is cleared.

## 5.5 Print-related Problems

### S **Print faint or of poor quality.**

- S Have you used the correct paper? See section **6 Technical Data** which contains a full specification of the paper you can use. Replace the paper if it does not match with the specification.
- S Make sure that the ribbon is stretched correctly.
- S Does the ribbon need changing? Replace it with a new ribbon if necessary.
- S Is the ribbon cassette properly installed? Adjust as necessary.

### S **Characters do not print evenly or are not uniform in pitch**

- S Examine the paper path for dirt or other obstruction that may cause the gap between print head and platen to vary. Remove the obstruction.

### S **Print lines overlap**

- S Examine the paper path for dirt or other obstructions that may prevent the platen from rotating freely. Remove the obstruction.

### S **On preprinted forms, the printing on the copies is not aligned with the preprinted matter**

- S Refer to section **3.4 Vertical Positioning VERT.POS.ADJ.**

### S **Part of printed text is missing (loss of data)**

- S If you are using Serial communications check the buffer control setting in Set-up.
- S Check the data flow control setting on the host computer.



**S Font cartridge has been installed, but the printer is still using internal fonts**

- S Switch the power OFF and check that the font cartridge has been correctly inserted.
- S Check that the font cartridge has been selected in the printer Set-up (see **Appendix B**).

If the printout or the character set is not ok, the following procedure can help to clear the situation.

Action	Result	Check
<b>Select and start PRINT TEST 1</b>	Print not OK?	<ul style="list-style-type: none"> <li>S PAPER SOURCE selection incorrect</li> <li>S Ribbon worn or not installed</li> <li>S Print head worn</li> </ul>
<b>Stop SELF TEST and start regular printing</b>	No printing starts	<ul style="list-style-type: none"> <li>S Printer <b>READY 1ELQ</b></li> <li>S Interface cable not connected properly</li> <li>S Interface selection incorrect</li> </ul>
	Some characters not correct	<ul style="list-style-type: none"> <li>S Emulation</li> <li>S Character set</li> <li>S National version</li> <li>S Word length</li> <li>S Baud rate</li> <li>S Parity bit</li> <li>S Protocol</li> </ul>
	Font and pitch quality false	<ul style="list-style-type: none"> <li>S Font</li> <li>S Pitch</li> <li>S Line space</li> </ul>
	Problem still there?	<ul style="list-style-type: none"> <li>S Call service</li> </ul>

## 5.6 Paper Jam

For the following steps stand in front of the printer, facing the tractor cassettes.

S Lift and remove the top cover.

S Grasp the cutter housing (only for **CI - 4080**) on both sides. Press down the green knob on the handles (84) using your thumbs and swing the cutter to the rear. The spring clips (82) will keep the cutter in this position.

The area where paper could be jammed is accessible now.

**Note:** On the ledge covering the blade in the **CI - 4080** is a label that cautions against touching the blade.

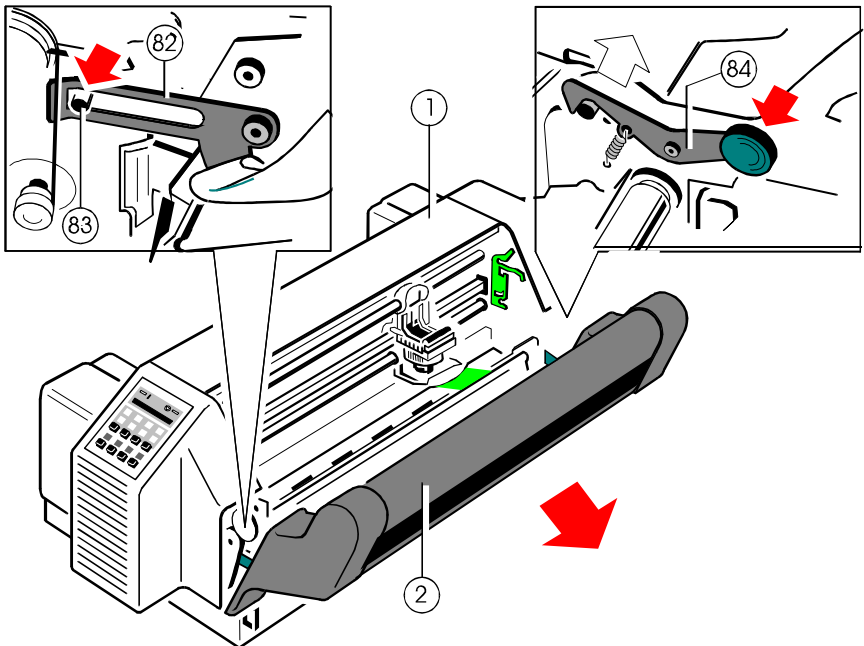

In the following descriptions of paper jam recovery it is assumed that you stand in front of the printer, facing the tractor cassettes.

- S The metal bar going through the paper guide plate above the platen is the so-called "D-shaft" (the shaft has a flattened top and resembles a capital D in its cross section). There is a green lever to the right end of the D-shaft. If you swing this lever toward the cutter the pick-up rollers lift slightly, allowing easy access to paper jammed in that area.
- S Remove the green screws holding the paper guide plate. Remove the paper guide plate by lifting it slightly and pulling the D-shaft toward the right out of its case. Jammed paper is accessible now.
- S If the paper in the **CI - 4080** is caught in the guide of the cutter the ledge covering the blade can be tipped up to access the paper.
- S Cutting through a sticky label leaves glue on the blade, leading to problems with the cutting device. Small parts of a cut through label could detach from its paper and get stuck under the shield of the print head or even block the cutter completely. If the shield or the blade gets dirty it must be cleaned immediately. Use a cloth with petrol.  
Caution: There is danger to get hurt.

**Note:** Be careful when accessing the blade in the **CI - 4080**, it is extremely sharp.

Depending on which of the above recovery methods have been applied, carry out the following steps:

- S Swing back the D-shaft
- S Lead the D-shaft into its case and fasten the green screws on the paper guide plate
- S Swing back the ledge to cover the blade (only **CI - 4080**)

Grasp the cutter housing (**CI - 4080**) left and right with both hands and press it toward the printer so that the handles (84) lock visible and with an audible click.

Reapply and close the top cover. Press  to reactivate the printer.

## 5.7 Ribbon or Carriage-related Problems

### S **Ribbon Problems**

- S Make sure that the ribbon is:
  - S Stretched correctly
  - S Not worn thin or dry
  - S Not torn or damaged in any other way
  - S Not jammed

### S **Carriage does not move smoothly**

- S Examine the paper path. Remove any obstructions. Check that all packing material is removed.
- S Examine the carriage area for obstructions. Remove where necessary.

## 5.8 Print Tests

There are three different print tests as well as one interface test built into the printer.

S **I/F TEST** is used to test the serial interface. It initiates data to be sent from the printer and be returned by means of a closed loop connector plugged into the serial interface connector. The test data used consist of **PRINT TEST 1**

**Note:** You will find detailed informations about the print tests in chapter 1.8 **Print Tests**.

## 6. Technical Data

The following technical data refers to the standard Personality Module (PM Ser/Par).

### **Print head technology**

Serial Impact Dot Matrix (SIDM) technology.

### **Paper path**

Flat bed technology.

### **Print head**

24 needles, needle diameter 0.25 mm (0.01 inch), lifetime approximately 350,000 pages (standard DIN letter)

### **Fonts**

Data, Roman, San Serif, Courier, Prestige, Script, OCR B, OCR A, Orator-C, Orator, DATA LARGE; all fonts (except Data and DATA LARGE) in Letter Quality (LQ) and Near Letter Quality (NLQ). OCR A, OCR B only in LQ.

### **Character Attributes**

Bold, double strike, italic, underline, double underline, overline, strike through, sub/superscript, condensed; double, triple, quadruple up to eightfold height and width; DATA LARGE up to 999-fold size.

### **Character Pitch**

Standard character pitches are: 10, 12, 15, 17, 18, 20 cpi and proportional. In addition, commands are defined to select non-standard character pitches. It is also possible to print overlapped characters. Fonts will be compressed if smaller pitches are selected.**Reference**)

### **Emulations**

S IBM® 4207 Proprinter XL24 (AGM)

S EPSON® LQ 1060 / 2550 / ESC/P2

**Print Speed** (at 10 cpi)

- S Draft Quality 700 cps,
- S Near Letter Quality 350 cps,
- S Letter Quality 175/117 cps\*\*.

**Throughput acc. to ECMA-132**

Standard Letter (Dr. Grauert)

**1-play fanfold**

- Draft Quality: 750\* pages/h
- Near Letter Quality: 520\* pages/h
- Letter Quality: 320\* pages/h\*\*
- \* Performance
- \*\* depending on the selected font

**Character Sets** (see also Appendix C "Character Set Tables")

- S Code Pages **EE**: 437 GK, 851 GK, 928 GK, 855 CYRI, 852, 866, 869, Kamenicky, ISO Latin 2, Mazovia, 437 HUN, 852 SEE, 866 LAT, WIN LAT 2.
- S Code Pages **EE2**: 771, 773, 774, 775, Baltic RIM.
- S IBM Character Set 1/2 incl. 14 national versions.
- S IBM Code Page 437, 850, 858, 860, 863, 865.
- S EPSON Extended Graphic Character Set incl. 15 national versions.

**Barcode**

- S Code 39, 2 of 5 industrial, 2 of 5 interleaved, Codabar (Monarch), EAN 8, EAN 13, Code 93, MSI Mod 10/10, UPC-E, UPC-A, Code 128 (incl. EAN 128), Postnet, and KIX Code (see also Appendix **F Barcode Quick Reference**)

**Graphics**

- Max. resolution (V x H). 180 x 360: Single pass
- 360 x 360: Double pass.

**Graphics Quality**

Selectable are: Standard, Win.LQ 180 dpi, Win.NLQ 90 dpi, or Win.Draft 60 dpi

**Print format**

136 characters at 10 cpi

### **Line Spacing**

2, 3, 4, 6, 8, 12 n/360 lpi

### **Platen Gap Control**

The Automatic Gap Control (AGC) adjusts the distance between print head and platen according to paper thickness and programmable Platen Gap Control (PCC).

### **Ribbon**

Black fabric ribbon for up to 16 million characters.

### **Copies**

1 original + 5 copies (max. total form thickness 0.5 mm [0.02 inch] ).

### **Paper Handling**

Integrated push tractor with park position for continuous paper, zero tear off, and for the **CI - 4080** also a cut function.

### **Paper output**

#### **CI - 4080**

S Batch output to the rear

S Stacker output to the top for single sheets, using the cutting device, face down in a logical order, capacity up to 200 sheets with 80g/m<sup>2</sup>, 1-play

S Batch output to the rear of cut sheets with the option cut sheet tray, capacity up to 600 sheets 80g/m<sup>2</sup>, 1-play

#### **CI - 4070**

S Batch output to the rear

**Paper specifications**

Paper-	Minimum	Maximum
width	101.6mm / 4"	420.9mm / 16.57"
height	76.2mm / 3"	558.8mm / 22"
weight		
S 1-play	60 g/m <sup>2</sup> / 16 lb/r	90 g/m <sup>2</sup> / 24 lb/r
S sheet in form set	40 g/m <sup>2</sup> / 10 lb/r	60 g/m <sup>2</sup> / 16 lb/r
S total set		350 g/m <sup>2</sup> / 91 lb/r
total form set thickness		
S printing area		0.5 mm / 0.02"
S area of top glued (only paper movement)		1.1 mm / 0.044"
S cutter (only <b>CI - 4080</b> )		1.1 mm / 0.044"

**Processing sticky labels:**

S the surface of a label must be absorbent for the liquid of the ribbon

S labels must not detach from the fanfold paper

S If the edges do not adhere to the paper the label could get stuck under the shield of the print head

**Processing sticky labels on the CI - 4080:**

S Cutting through a sticky label leaves glue on the blade, leading to problems with the cutting device. Small parts of a cut through label could detach from its paper and get stuck under the shield of the print head or even block the cutter completely.

**Interface**

S Parallel Centronics®

S Serial RS-232-C/V.24

**Buffer**

S Up to 30 Kbyte in selectable sizes;

optional with RAM Extension up to 160 KB possible



**Diagnostics**

Selftest, `Hex dump', device status and remote diagnostics via interface.

**Control Panel**

16 character LCD for menu controlled setup, status- and error messages.

**Dimensions**

	<b>CI - 4080</b>	<b>CI - 4070</b>
Width	740 mm / 29.6"	740 mm / 29.6"
Depth	455 mm / 18.2" (incl. tractor cassette)	370 mm / 14.8" (incl. tractor cassette)
Height	327 mm / 13.1" (without stacker)	325 mm / 13"

**Weight**

**CI - 4070** 28.8 kg / 63 lbs

**CI - 4080** 33 kg / 72 lbs

**Rated Voltage**

100 - 120 / 200 - 240 V~ at rated f = 50 - 60 Hz

**Power Consumption**

200 W operating, 40 W stand by.

**Environmental Temperature**

Operating: + 10EC to + 35EC (+ 50EF to + 95EF)

Storage: - 40EC to + 70EC (- 40EF to + 158EF)

**Relative Humidity**

20% - 80% (operating)

5% - 85% (storage)

**Noise**

Less than 55 dB(A) (operating) ISO 7779

(sound level measured from outside of the housing by an distance of 39.5 inch)

## **MTBF**

10,000 h at 30% duty cycle

## **Agency Approvals**

Acc. to VDE (IEC 950 and CSA 22.2/No. 220-M91), UL 478, CSA; listing mark for Canada is C-UL

## **EMI Approvals**

Acc. to regulation of FTZ/FCC, class B

## **Printer Stand**

Provides is the optimum work station convenience.

width = 630 mm / 25"

depth = 620 mm / 24.8"

710 mm / 28" (optional with V-Stacker Support)

height = 860 mm / 34"

## **V-Stacker Support**

Optional to lay down fanfold paper in the best way

width = 460 mm / 18.4"

depth = 320 mm / 12.8"

height = 450 mm / 18"

## **Cut Sheet Tray only for CI - 4080**

Optional to collect single sheets for output at the rear (**BATCH**)

width = 440 mm / 17.6"

depth = 240 mm / 9.6" for short formats (shortest position)

360 mm / 14.4" for long formats

height = 200 mm / 8"

capacity = up to 600 single sheets

## **Tractor Cassette**

A convenient option for quick changes of different types of fanfold paper and form sets.

width = 520 mm / 20.8"

depth = 120 mm / 4.8"

height = 40 mm / 1.6"

## Appendix A System Interface Description

There are two system interfaces:

- S one serial interface with RS-232C
- S one Parallel Centronics interface.

The interfaces can be operated in three different modes:

- S serial interface active
- S parallel interface active
- S both interfaces active in shared mode

The following chapter gives an overview about interface characteristics, control signals, protocols, and cabling.

Any change to the operation mode (SERIAL, PARALLEL or SHARED) and to the size of the interface buffer is possible only when the interface buffer is completely empty of data.

## 1. Serial Interface RS-232C

### 1.1 Interface Characteristics

Signal Description RS-232C		Pin No.	Direction
PG	Protective Ground	1	-
TXD	Transmit Data (from printer to host)	2	OUTPUT
RXD	Receive Data (from host to printer)	3	INPUT
RTS	Request to Send (printer is requesting data transfer from host)	4	OUTPUT
CTS	Clear to Send (host is ready to receive data from printer)	5	INPUT
DSR	Data Set Ready (host is requesting data transfer from printer, can not be used for flow control, internally set to "1")	6	INPUT
SG	Signal Ground	7	-
DTR	Data Terminal Ready (printer is ready to receive - see also on the following pages the data communication protocols for detail meaning)	20	OUTPUT

S Transmission rate: 600, 1200, 2400, 4800, 9600, or 19200 baud

S Parity: even, odd, none, or ignore

S Word length: 7, or 8 bits

S Number of stop bits: In receive mode the printer accepts 1, or 2 stop bits. The printer transmits always two bits.

#### Transmission Protocols:

S DTR - Ready/Busy (only RS-232C)

S XON/XOFF

S XON/XOFF + DTR

## 1.2 Transmission Protocols and Connection Diagrams

### 1.2.1 DTR - Ready/Busy

(Supported RS-232C Protocols) - Full Duplex Local Connection

This protocol uses the following signal lines:

- S Pin 1 Protective Ground (PG)
- S 2 Transmit Data (TXD)
- S 3 Receive Data (RXD)
- S 5 Clear to Send (CTS)
- S 7 Signal Ground (SG)
- S 20 Data Terminal Ready (DTR)

**Note:** The signal lines TXD (pin 2) and CTS (pin 5) are only necessary if the Device Status Report is required.

The READY / BUSY DTR protocol uses the DATA TERMINAL READY (DTR) line to control the transmission of data from the host to prevent a buffer overflow.

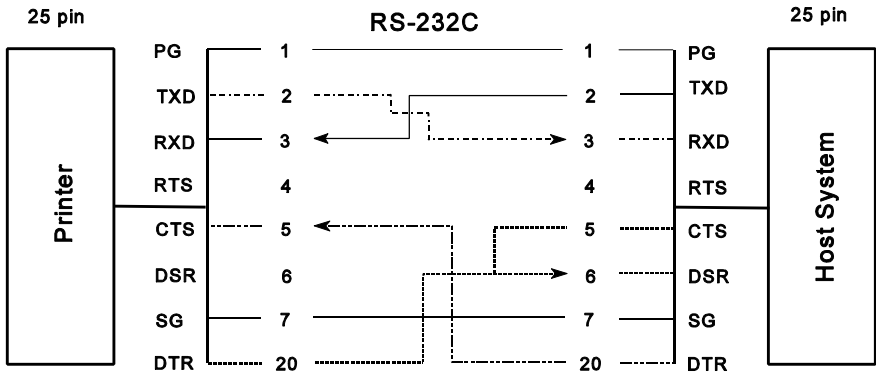

**Note:** Printer DTR may be connected to host DSR + CTS or only to host DSR and a bridge between RTS and CTS.

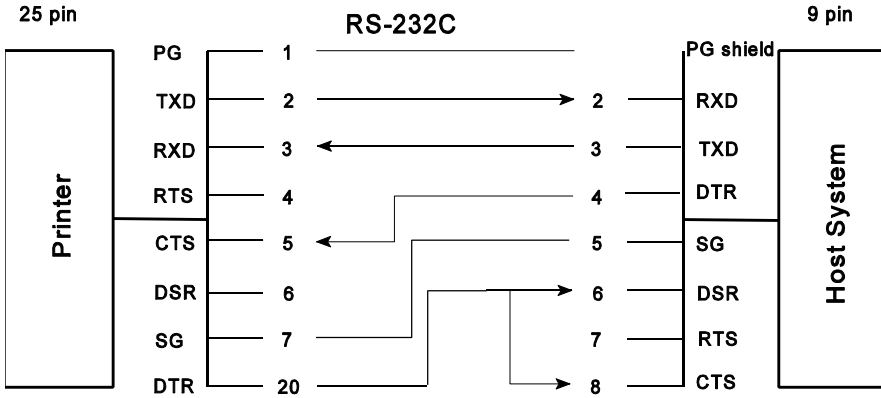

**Note:** Printer DTR may be connected to host DSR + CTS or only to host DSR and a bridge between RTS and CTS.

### Additional Information

After Power-ON DTR is activated and the printer is ready to receive data.

DTR is deactivated when the interface buffer has only space left for 256 more characters. Further incoming data will be stored until the interface buffer is full. All data sent in addition will get lost. DTR is activated again if there is a free interface buffer space of 512 characters.

DTR is immediately deactivated, if local mode is entered.

It is activated again, if local mode is left and a minimum of 512 bytes interface buffer is available.

### 1.2.2 XON / XOFF

This protocol requires all signal lines.

- S Pin 1 Protective Ground (PG)
- S 2 Transmit Data (TXD)
- S 3 Receive Data (RXD)
- S 4 Request to Send (RTS)
- S 5 Clear to Send (CTS)
- S 6 Data Set Ready (DSR)
- S 7 Signal Ground (SG)
- S 20 Data Terminal Ready (DTR)

#### Standard Connection

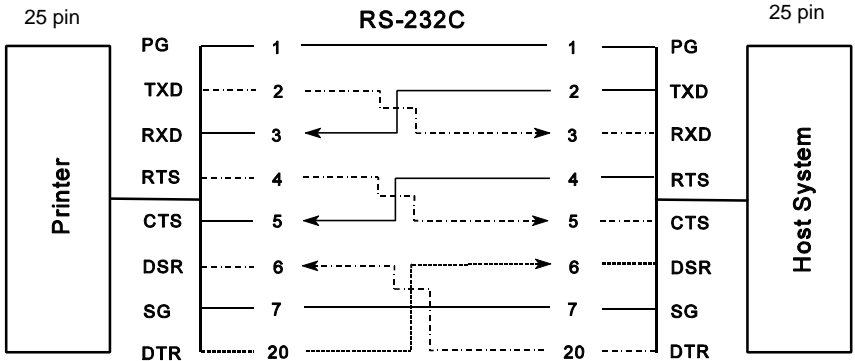

For local connections **RTS** with **CTS** can be connected and likewise **DTR** with **DSR**.

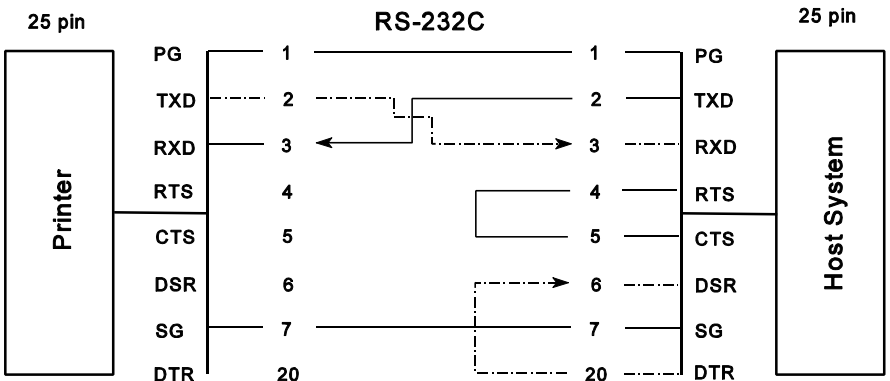

### **Additional Information**

After Power-ON DTR and RTS are activated and the printer is ready to receive data.

**XOFF** is sent, when the interface buffer has only space left for 256 more characters. **XOFF** is sent again, at a level of 128 characters buffer space. Further incoming data will be stored until the interface buffer is full. All data sent in addition will get lost.

**XON** is sent when the interface buffer provides space for a minimum of 512 characters.

**XON/XOFF** can only be sent successfully when **CTS** is at active state. When the CTS Mode is set to "CTS ignore" CTS is allways in the active state.

**XOFF** will be sent immediately if local mode is entered.

**XON** is sent again, if local mode is left and a minimum of 512 byte interface buffer is available.



## 2. Parallel Centronics® Interface

### 2.1 Interface Characteristics - Connector Pin Assignment / Signal Definition

Signal Description		Pin No.	Return line Pin No.	Direction
<u>STROBE</u> <sup>)</sup>	Control Signal from the Host. Printer reads data line (Data 1 to Data 8) when going low.	1	19	Input
Data 1 - 8	Data lines transfer the characters from the host to the printer. Data 8 = most significant bit.	2 - 9	20 - 27	Input
<u>ACKN</u> <sup>)</sup>	Acknowledge - Negative going pulse from the printer indicates that the printer has received a character and is ready for the next data transfer.	10	28	Output
<u>BUSY</u>	Control signal from the printer. A high level indicates that the printer is unable to receive any more data.**)	11	29	Output
<u>PE</u>	Paper Empty - Control signal from the printer. This signal goes high when paper runs out, i.e. load upper or lower tractor, paper jam.	12	--	Output
<u>SELECT</u>	Control signal from the printer. A high level indicates that the printer is <b>ON-LINE</b> and ready.	13	--	Output
<u>LG</u>	Logic Ground	14	--	
--	not used	15	--	
<u>LG</u>	Logic Ground	16	--	
<u>CG</u>	Chassis Ground	17	--	
<u>VCC</u>	+ 5 volt	18	--	
<u>SG</u>	Signal Ground	19 - 20	--	
<u>INIT</u> <sup>)</sup>	Control signal from the host. Does not reset the printer.	31	--	Input
<u>FAULT</u> <sup>)</sup>	Control signal from the printer. A low level indicates that the printer has been switched off, or the serial interface is active.	32	--	Output
<u>LG</u>	Logic Ground	33	--	
--	not used	34 - 35	--	

<sup>)</sup> Overlined signal names indicate that the signal is true when the signal level is low.

\*\*<sup>)</sup> When the interface buffer is full except for the last character, **BUSY** will not be reset. **BUSY** will be reset when buffer space is available again for least 512 characters in the interface buffer. While the printer is offline (Stop Mode) **BUSY** remains active until the printer enters the online state again.

## 2.2 Transmission Protocol Description

After Power-ON the **PE** (Paper Empty) signal is set to low level and the **SELECT** and **FAULT** signals are set to high level.

The printer is now **ON-LINE** and ready to receive data.

### Timing

The host sets a print/control character to the 8 data lines.

After a time delay of a minimum of 0.5  $\mu$ s, the host sends a **STRÖBE** pulse of a minimum of 0.5  $\mu$ s. When the data byte is accepted into the interface buffer the printer transmits a **BUSY** signal and an **ACKN** pulse.

The **ACKN** pulse informs the host that the data has been received and that the printer is ready to receive new data.

If the interface buffer is full except for the last character the **BUSY** is not reset in order to stop the data transfer from the host. The **BUSY** signal is only reset if space is available in the interface buffer for a minimum of 512 characters.

While the printer is offline, or a serial interface is active **BUSY** remains high and no **ACKN** is sent until the printer enters online state or the serial interface is deselected.

### 2.3 Timing Diagram

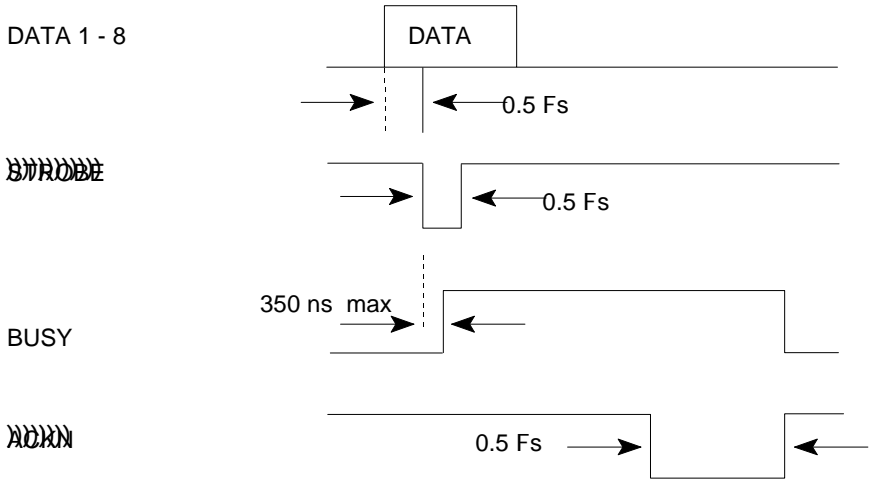

### 3. Shared Operation

In shared operation the interface buffer capacity is reduced by 256 bytes.

After Power-ON both the serial and the parallel interfaces are available for data transfer.

If a byte is first recognized by the serial interface the parallel interface is immediately disabled by the **BUSY** signal. The serial interface is now active and will operate, using the installed protocols.

If a byte is first recognized by the parallel interface either the **DTR** signal of the serial interface is set to **OFF** or **XOFF** is sent, depending on the protocol.

If the serial interface starts to receive data while the parallel interface is active, it is possible to receive 256 bytes of serial data. Any additional serial data will be lost.

When the interface buffer is completely empty of serial data, and no new data has been received by the serial interface for more than 10 seconds, both interfaces are available for data transfer again.

When the interface buffer is completely empty of parallel data and no data has been received by the parallel interface for more than 60 seconds, the 256 bytes of serial data will be processed. Afterwards, both interfaces are available for data transfer again.











DATA LARGE

§ ! " # \$ % & ' ( )

/ 0 1 2 3 4 5 6 7 8 9

? § A B C D E F G H I

O P Q R S T U V W X Y

\_ ' a b c d e f g h i

o p q r s t u v w x y

Ç ü é â ä à å ç ê ë

Å É æ Æ ô ö ó û ü ö

ƒ á í ó ú ħ Ń ě ı ı

Character Pitches

**COURIER LQ, 20 CPI 0123456789ABCDEF**

**COURIER LQ, 18 CPI 0123456789ABCDEF**

**COURIER LQ, 17 CPI 0123456789ABCDEF**

**COURIER LQ, 15 CPI 0123456789ABCDEF**

**COURIER LQ, 12 CPI 0123456789ABCDEF**

**COURIER LQ, 10 CPI 0123456789ABC**

**COURIER LQ, proport. 0123456789ABCDEF**

### COURIER outline

1234567890β , #+ ! " | \$%& / ( ) = ? ; ' \*  
ABCDEFGHIJKLMN O P Q R S T U V W X Y Z A O U  
abcdefghijklmnopqr stuvwxyzaöü

### COURIER shadow

1234567890β , #+ ! " | \$%& / ( ) = ? ; ' \*  
ABCDEFGHIJKLMN O P Q R S T U V W X Y Z A O U  
abcdefghijklmnopqr stuvwxyzaöü

### COURIER outline + shadow

1234567890β , #+ ! " | \$%& / ( ) = ? ; ' \*  
ABCDEFGHIJKLMN O P Q R S T U V W X Y Z A O U  
abcdefghijklmnopqr stuvwxyzaöü

COURIER

4xHeight 4xWidth outline

1 2 3 A B C a b c

COURIER

4xHeight 4xWidth shadow

1 2 3 A B C a b c

COURIER

4xHeight 4xWidth shadow + outline

1 2 3 A B C a b c

COURIER LQ, 10 CPI

0123456789ABCDEF

COURIER LQ, 1x HEIGHT 2x WIDTH

**0123456789ABCDEF**

COURIER LQ, 1x HEIGHT 3x WIDTH

**01234ABCDEF**

COURIER LQ, 1x HEIGHT 4x WIDTH

**01234ABC**

COURIER LQ, 1x HEIGHT 4x WIDTH, BOLD

**01234ABC**

COURIER LQ, 2x HEIGHT 1x WIDTH

0123456789ABCDEF

COURIER LQ, 3x HEIGHT 1x WIDTH

0123456789ABCDEF

COURIER LQ, 4x HEIGHT 1x WIDTH

0123456789ABCDEF

COURIER LQ, 4x HEIGHT 1x WIDTH, BOLD

0123456789ABCDEF

COURIER LQ, 2x HEIGHT 2x WIDTH

0123456789ABCDEF

COURIER LQ, 3x HEIGHT 3x WIDTH

01234ABCDEF

COURIER LQ, 4x HEIGHT 4x WIDTH

01234ABC

COURIER LQ, 4x HEIGHT 4x WIDTH, BOLD

01234ABC

## Appendix C Character Set Tables

### 1 Code Table IBM All Character Set

	0	1	2	3	4	5	6	7	8	9	A	B	C	D	E	F
0	i	<	∅	0	@	P	`	p	Ç	É	á	!	.	J	"	/
1	(	=	!	1	A	Q	a	q	ü	æ	í	"	2	L	\$	±
2	)	;	"	2	B	R	b	r	é	Æ	ó	#	0	H	'	\$
3	ì	.	#	3	C	S	c	s	â	ô	ú	*	/	F	B	#
4	È	¶	\$	4	D	T	d	t	ä	ö	ñ	1	)	B	E	!
5	Ê	§	%	5	E	U	e	u	à	ò	Ñ	I	3	?	F	"
6	Í	_	&	6	F	V	f	v	å	û	ª	M	G	C	µ	÷
7	!	O	*	7	G	W	g	w	ç	ù	º	D	K	O	J	.
8	3	8	(	8	H	X	h	x	ê	ÿ	¿	@	9	P	M	E
9	"	9	)	9	I	Y	i	y	ë	Ö	1	<	6	-	1	@
A	4	6	*	:	J	Z	j	z	è	Ü	¬	5	=	+	S	.
B	%	7	+	;	K	[	k	{	ï	ç	½	7	;	\$	*	%
C	&	2	'	<	L	\	l		î	£	¼	8	:	(	4	6
D	*	:	-	=	M	]	m	}	ì	¥	¡	E	4	%	ø	²
E	+	>	.	>	N	^	n	~	Ä	.	*	A	>	'	,	#
F	'	?	/	?	O	_	o		Å	f	+	,	N	&	1	∅

Applicable for Code Table IBM Set 1 and 2



## 2 Code Table IBM Set 1

National Version = USA

	0	1	2	3	4	5	6	7	8	9	A	B	C	D	E	F
0	NUL		SP	0	@	P	`	p	NUL		á	!	.	J	"	/
1		DC1	!	1	A	Q	a	q		DC1	í	"	2	L	\$	±
2		DC2	"	2	B	R	b	r		DC2	ó	#	0	H	'	\$
3		DC3	#	3	C	S	c	s		DC3	ú	*	/	F	B	#
4		DC4	\$	4	D	T	d	t		DC4	ñ	1	)	B	E	!
5			%	5	E	U	e	u			Ñ	I	3	?	F	"
6			&	6	F	V	f	v			ª	M	G	C	µ	÷
7	BEL		*	7	G	W	g	w	BEL		º	D	K	O	J	.
8	BS	CAN	(	8	H	X	h	x	BS	CAN	¿	@	9	P	M	E
9	HT		)	9	I	Y	i	y	HT		1	<	6	-	1	@
A	LF		*	:	J	Z	j	z	LF		¬	5	=	+	S	.
B	VT	ESC	+	;	K	[	k	{	VT	ESC	½	7	;	\$	*	%
C	FF		'	<	L	\	l		FF		¼	8	:	(	4	6
D	CR		-	=	M	]	m	}	CR		¡	E	4	%	ø	²
E	SO		.	>	N	^	n	~	SO		*	A	>	'	,	#
F	SI		/	?	O	_	o		SI		+	,	N	&	1	SP

## 2.1 National Version IBM Set 1

	Character Code (Hex)											
	23	24	40	5B	5C	5D	5E	60	7B	7C	7D	7E
1: USA	#	\$	@	[	\	]	^	`	{		}	~
2: FRANCE	#	\$	à	É	ç	§	^	`	é	ù	è	”
3: GERMANY	#	\$	§	Ä	Ö	Ü	^	`	ä	ö	ü	ß
4: U.K.	£	\$	@	[	\	]	^	`	{		}	~
5: DENMARK	#	\$	@	Æ	Ø	Å	^	`	æ	ø	å	~
6: SWEDEN	#	¤	É	Ä	Ö	Å	Ü	é	ä	ö	å	ü
7: ITALY	#	\$	@	É	\	é	^	ù	à	ò	è	ì
8: SPAIN	.	\$	@	ı	Ñ	ı	^	`	”	ñ	}	~
9: JAPAN	#	\$	@	[	¥	]	^	`	{		}	~
10: NORWAY	#	¤	É	Æ	Ø	Å	Ü	é	æ	ø	å	ü
11: DENMARK 2	#	\$	É	Æ	Ø	Å	Ü	é	æ	ø	å	ü
12: SPAIN 2	#	\$	á	ı	Ñ	ı	é	`	ı	ñ	ó	ú
13: LATIN AM.	#	\$	á	ı	Ñ	ı	é	Ü	ı	ñ	ó	ú
14: TURKEY	#	§	ı	Ç	Ö	Ô	Ü	™	ç	ö	õ	ü

### 3 Code Table IBM Set 2

	0	1	2	3	4	5	6	7	8	9	A	B	C	D	E	F
0	NUL		SP	0	@	P	`	p	Ç	É	á	!	.	J	"	/
1		DC1	!	1	A	Q	a	q	ü	æ	í	"	2	L	\$	±
2		DC2	"	2	B	R	b	r	é	Æ	ó	#	0	H	'	\$
3	ì	DC3	#	3	C	S	c	s	â	ô	ú	*	/	F	B	#
4	Ë	DC4	\$	4	D	T	d	t	ä	ö	ñ	1	)	B	E	!
5	Ê	§	%	5	E	U	e	u	à	ò	Ñ	I	3	?	F	"
6	Í		&	6	F	V	f	v	â	û	ª	M	G	C	µ	÷
7	BEL		*	7	G	W	g	w	ç	ù	º	D	K	0	J	.
8	BS	CAN	(	8	H	X	h	x	ê	ÿ	¿	@	9	P	M	E
9	HT		)	9	I	Y	i	y	ë	Ö	1	<	6	-	1	@
A	LF		*	:	J	Z	j	z	è	Ü	¬	5	=	+	S	.
B	VT	ESC	+	;	K	[	k	{	ï	ç	½	7	:	\$	*	%
C	FF		'	<	L	\	l		î	£	¼	8	:	(	4	6
D	CR		-	=	M	]	m	}	ì	¥	¡	E	4	%	ø	²
E	SO		.	>	N	^	n	~	Ä	.	*	A	>	'	,	#
F	SI		/	?	O	_	o		Å	f	+	,	N	&	1	SP

### 3.1 National Version IBM Set 2

	Character Code (Hex)													
	23	24	40	5B	5C	5D	5E	60	7B	7C	7D	7E	9B	9D
1: USA	#	\$	@	[	\	]	^	`	{		}	~	¢	¥
2: FRANCE	#	\$	à	É	ç	§	^	`	é	ù	è	¨	¢	¥
3: GERMANY	#	\$	§	Ä	Ö	Ü	^	`	ä	ö	ü	ß	¢	¥
4: U.K.	£	\$	@	[	\	]	^	`	{		}	~	¢	¥
5: DENMARK	#	\$	@	[	\	]	^	`	{		}	~	ø	Ø
6: SWEDEN	#	¤	É	Ä	Ö	Å	Ü	é	ä	ö	å	ü	¢	¥
7: ITALY	#	\$	@	É	\	é	^	ù	à	ò	è	ì	¢	¥
8: SPAIN	.	\$	@	i	Ñ	¿	^	`	¨	ñ	}	~	¢	¥
9: JAPAN	#	\$	@	[	¥	]	^	`	{		}	~	¢	¥
10: NORWAY	#	\$	@	[	\	]	^	`	{		}	~	ø	Ø
11: DEMARK 2	#	\$	@	[	\	]	^	`	{		}	~	ø	Ø
12: SPAIN 2	#	\$	á	i	Ñ	¿	é	`	í	ñ	ó	ú	¢	¥
13: LATIN AM.	#	\$	á	i	Ñ	¿	é	Ü	í	ñ	ó	ú	¢	¥
14: TURKEY	#	§	ı	Ç	Ö	Õ	Ü	™	ç	ö	õ	ü	¢	¥

#### 4 Code Table IBM Code Page

Code Page	Countries
1: Code Page 437	USA
2: Code Page 850	Germany, U.K., Denmark, Sweden, Italy, Spain, Japan, Latin Am., Turkey
3: Code Page 860	Portugal
4: Code Page 863	France
5: Code Page 865	Norway
6: Code Page 858	Germany, U.K., Denmark, Sweden, Italy, Spain, Japan, Latin Am, Turkey; inc. € Symbol

## 4.1 IBM Code Page 437

	0	1	2	3	4	5	6	7	8	9	A	B	C	D	E	F
0	i	<	Œ	0	@	P	`	p	Ç	É	á	!	.	J	"	/
1	(	=	!	1	A	Q	a	q	ü	æ	í	"	2	L	\$	±
2	)	;	"	2	B	R	b	r	é	Æ	ó	#	0	H	'	\$
3	ï	.	#	3	C	S	c	s	â	ô	ú	*	/	F	B	#
4	Ë	¶	\$	4	D	T	d	t	ä	ö	ñ	1	)	B	E	!
5	Ê	§	%	5	E	U	e	u	à	ò	Ñ	I	3	?	F	"
6	Í	_	&	6	F	V	f	v	â	û	ª	M	G	C	µ	÷
7	!	O	*	7	G	W	g	w	ç	ù	º	D	K	O	J	.
8	3	8	(	8	H	X	h	x	ê	ÿ	¿	@	9	P	M	E
9	"	9	)	9	I	Y	i	y	ë	Ö	1	<	6	-	1	@
A	4	6	*	:	J	Z	j	z	è	Ü	¬	5	=	+	S	.
B	%	7	+	;	K	[	k	{	ï	¢	½	7	:	\$	*	%
C	&	2	'	<	L	\	l		î	£	¼	8	:	(	4	6
D	*	:	-	=	M	]	m	}	ì	¥	¡	E	4	%	ø	²
E	+	>	.	>	N	^	n	~	Ä	.	*	A	>	'	,	#
F	'	?	/	?	O	_	o		Å	f	+	,	N	&	1	Œ

4.2 IBM Code Page 850

	0	1	2	3	4	5	6	7	8	9	A	B	C	D	E	F
0	i	<	Œ	0	@	P	`	p	Ç	É	á	!	.	ð	Ó	-
1	(	=	!	1	A	Q	a	q	ü	æ	í	"	2	Ð	\$	±
2	)	;	"	2	B	R	b	r	é	Æ	ó	#	0	Ê	Ô	=
3	ï	.	#	3	C	S	c	s	â	ô	ú	*	/	Ë	Ò	¾
4	Ë	¶	\$	4	D	T	d	t	ä	ö	ñ	1	)	È	õ	¶
5	Ê	§	%	5	E	U	e	u	à	ò	Ñ	Á	3	í	Õ	§
6	Í	_	&	6	F	V	f	v	â	û	ª	Â	ã	í	µ	÷
7	!	0	*	7	G	W	g	w	ç	ù	º	À	Ã	î	þ	,
8	3	8	(	8	H	X	h	x	ê	ÿ	¿	©	9	ï	ƒ	Ç
9	"	9	)	9	I	Y	i	y	ë	Ö	®	<	6	-	Ú	"
A	4	6	*	:	J	Z	j	z	è	Ü	¬	5	=	+	Û	<
B	%	7	+	;	K	[	k	{	ï	ø	½	7	;	§	Ù	¹
C	&	2	'	<	L	\	l		î	£	¼	8	:	(	ý	³
D	*	:	-	=	M	]	m	}	ì	Ø	ì	¢	4		Ý	²
E	+	>	.	>	N	^	n	~	Ä	x	*	¥	>	ì	-	#
F	'	?	/	?	O	_	o		Å	f	+	,	¤	&	'	Œ

4.3 IBM Code Page 858

	0	1	2	3	4	5	6	7	8	9	A	B	C	D	E	F
0	ı	<	Œ	0	@	P	`	p	Ç	É	á	!	.	đ	Ó	-
1	(	=	!	1	A	Q	a	q	ü	æ	í	"	2	Đ	\$	±
2	)	;	"	2	B	R	b	r	é	Æ	ó	#	0	Ê	Ô	=
3	İ	.	#	3	C	S	c	s	â	ô	ú	*	/	Ë	Ò	¼
4	Ë	¶	\$	4	D	T	d	t	ä	ö	ñ	1	)	È	õ	¶
5	Ê	§	%	5	E	U	e	u	à	ò	Ñ	Á	3	€	Õ	§
6	Í	_	&	6	F	V	f	v	â	û	ª	Â	ã	ı	µ	÷
7	!	0	*	7	G	W	g	w	ç	ù	º	À	Ã	î	þ	¸
8	3	8	(	8	H	X	h	x	ê	ÿ	¿	©	9	İ	þ	4
9	"	9	)	9	I	Y	i	y	ë	Ö	®	<	6	-	Ú	"
A	4	6	*	:	J	Z	j	z	è	Ü	¬	5	=	+	Û	<
B	%	7	+	;	K	[	k	{	ï	ø	½	7	;	š	Ù	¹
C	&	2	'	<	L	\	l		î	£	¼	8	:	(	ý	³
D	*	:	-	=	M	]	m	}	ì	Ø	ı	ç	4		Ý	²
E	+	>	.	>	N	^	n	~	Ä	x	*	¥	>	ì	-	#
F	'	?	/	?	O	_	o		Å	f	+	,	¤	&	'	Œ



4.4 IBM Code Page 860

	0	1	2	3	4	5	6	7	8	9	A	B	C	D	E	F
0	i	<	Œ	0	@	P	`	p	Ç	É	á	!	.	J	"	/
1	(	=	!	1	A	Q	a	q	ü	À	í	"	2	L	\$	±
2	)	;	"	2	B	R	b	r	é	È	ó	#	0	H	'	\$
3	ï	.	#	3	C	S	c	s	â	ô	ú	*	/	F	B	#
4	Ë	¶	\$	4	D	T	d	t	ã	õ	ñ	1	)	B	E	!
5	Ê	§	%	5	E	U	e	u	à	ò	Ñ	I	3	?	F	"
6	Í	_	&	6	F	V	f	v	Á	Ú	a	M	G	C	μ	÷
7	!	0	*	7	G	W	g	w	ç	ù	°	D	K	0	J	.
8	3	8	(	8	H	X	h	x	ê	ì	¿	@	9	P	M	E
9	"	9	)	9	I	Y	i	y	Ê	Õ	Ò	<	6	-	1	@
A	4	6	*	:	J	Z	j	z	è	Ü	¬	5	=	+	S	.
B	%	7	+	;	K	[	k	{	í	ø	½	7	;	\$	*	%
C	&	2	'	<	L	\	l		ô	£	¼	8	:	(	4	6
D	*	:	-	=	M	]	m	}	ì	Ù	¡	E	4	%	ø	²
E	+	>	.	>	N	^	n	~	Ã	.	*	A	>	'	,	#
F	'	?	/	?	O	_	o		Â	Ó	+	,	N	&	1	Œ

### 4.5 IBM Code Page 863

	0	1	2	3	4	5	6	7	8	9	A	B	C	D	E	F
0	i	<	Œ	0	@	P	`	p	Ç	É		!	.	J	"	/
1	(	=	!	1	A	Q	a	q	ü	È	'	"	2	L	\$	±
2	)	;	"	2	B	R	b	r	é	Ê	ó	#	0	H	'	\$
3	ï	.	#	3	C	S	c	s	â	ô	ú	*	/	F	B	#
4	Ë	¶	\$	4	D	T	d	t	Â	Ë	"	1	)	B	E	!
5	Ê	§	%	5	E	U	e	u	à	ï	,	I	3	?	F	"
6	Í	_	&	6	F	V	f	v	¶	û	³	M	G	C	µ	÷
7	!	O	*	7	G	W	g	w	ç	ù	-	D	K	O	J	.
8	3	8	(	8	H	X	h	x	ê	æ	î	@	9	P	M	E
9	"	9	)	9	I	Y	i	y	ë	Ô	1	<	6	-	1	@
A	4	6	*	:	J	Z	j	z	è	Ü	¬	5	=	+	S	.
B	%	7	+	;	K	[	k	{	ï	ç	½	7	;	\$	*	%
C	&	2	'	<	L	\	l		î	£	¼	8	:	(	4	6
D	*	:	-	=	M	]	m	}	=	Ù	¾	E	4	%	ø	²
E	+	>	.	>	N	^	n	~	À	Û	*	A	>	'	,	#
F	'	?	/	?	O	_	o		§	f	+	,	N	&	1	Œ

4.6 IBM Code Page 865

	0	1	2	3	4	5	6	7	8	9	A	B	C	D	E	F
0	i	<	Œ	0	@	P	`	p	Ç	É	á	!	.	J	"	/
1	(	=	!	1	A	Q	a	q	ü	æ	í	"	2	L	\$	±
2	)	;	"	2	B	R	b	r	é	Æ	ó	#	0	H	'	\$
3	ï	.	#	3	C	S	c	s	â	ô	ú	*	/	F	B	#
4	Ë	¶	\$	4	D	T	d	t	ä	ö	ñ	1	)	B	E	!
5	Ê	§	%	5	E	U	e	u	à	ò	Ñ	I	3	?	F	"
6	Í	_	&	6	F	V	f	v	â	û	ª	M	G	C	µ	÷
7	!	0	*	7	G	W	g	w	ç	ù	º	D	K	0	J	.
8	3	8	(	8	H	X	h	x	ê	ÿ	¿	@	9	P	M	E
9	"	9	)	9	I	Y	i	y	ë	Ö	1	<	6	-	1	@
A	4	6	*	:	J	Z	j	z	è	Ü	¬	5	=	+	S	.
B	%	7	+	;	K	[	k	{	ï	ø	½	7	;	\$	*	%
C	&	2	'	<	L	\	l		î	£	¼	8	:	(	4	6
D	*	:	-	=	M	]	m	}	ì	Ø	¡	E	4	%	ø	²
E	+	>	.	>	N	^	n	~	Ä	.	*	A	>	'	,	#
F	'	?	/	?	O	_	o		Å	f	¤	,	N	&	1	Œ

**5 EPSON Extended Graphics Character Table**

	0	1	2	3	4	5	6	7	8	9	A	B	C	D	E	F
0			SP	0	@	P	`	p	Ç	É	á	!	.	J	"	/
1			!	1	A	Q	a	q	ü	æ	í	"	2	L	\$	±
2			"	2	B	R	b	r	é	Æ	ó	#	0	H	'	\$
3			#	3	C	S	c	s	â	ô	ú	*	/	F	B	#
4			\$	4	D	T	d	t	ä	ö	ñ	1	)	B	E	!
5		§	%	5	E	U	e	u	à	ò	Ñ	I	3	?	F	"
6			&	6	F	V	f	v	â	û	ª	M	G	C	µ	÷
7			*	7	G	W	g	w	ç	ù	º	D	K	O	J	.
8			(	8	H	X	h	x	ê	ÿ	¿	@	9	P	M	E
9			)	9	I	Y	i	y	ë	Ö	1	<	6	-	1	@
A			*	:	J	Z	j	z	è	Ü	¬	5	=	+	S	.
B			+	;	K	[	k	{	ï	ø	½	7	;	\$	*	%
C			'	<	L	\	l		î	£	¼	8	:	(	4	6
D			-	=	M	]	m	}	ì	¥	¡	E	4	%	ø	²
E			.	>	N	^	n	~	Ä	.	*	A	>	'	,	#
F			/	?	O	_	o		Å	f	+	,	N	&	1	SP

### 5.1 National Version EPSON Extended graphics Character Table

	Character Code (Hex)											
	23	24	40	5B	5C	5D	5E	60	7B	7C	7D	7E
1: USA	#	\$	@	[	\	]	^	`	{		}	~
2: FRANCE	#	\$	à	E	ç	§	^	`	é	ù	è	¨
3: GERMANY	#	\$	§	Ä	Ö	Ü	^	`	ä	ö	ü	ß
4: U.K.	£	\$	@	[	\	]	^	`	{		}	~
5: DENMARK	#	\$	@	Æ	Ø	Å	^	`	æ	ø	å	~
6: SWEDEN	#	¤	É	Ä	Ö	Å	Ü	é	ä	ö	å	ü
7: ITALY	#	\$	@	E	\	é	^	ù	à	ò	è	ì
8: SPAIN	.	\$	@	i	Ñ	¿	^	`	¨	ñ	}	~
9: JAPAN	#	\$	@	[	¥	]	^	`	{		}	~
10: NORWAY	#	¤	É	Æ	Ø	Å	Ü	é	æ	ø	å	ü
11: DENMARK 2	#	\$	É	Æ	Ø	Å	Ü	é	æ	ø	å	ü
12: SPAIN 2	#	\$	á	i	Ñ	¿	é	`	í	ñ	ó	ú
13: LATIN AM.	#	\$	á	i	Ñ	¿	é	Ü	í	ñ	ó	ú
14: TURKEY	#	§	ı	Ç	Ö	Ö	Ü™	ç	ö	ö	ü	
15: LEGAL	#	\$	§	E	'	"	¶	`	©	®	†	™

## 5.2 EPSON Italic Character Table

	0	1	2	3	4	5	6	7	8	9	A	B	C	D	E	F
0			Œ	0	@	P	`	p			Œ	0	@	P	`	p
1			!	1	A	Q	a	q			!	1	A	Q	a	q
2			"	2	B	R	b	r			"	2	B	R	b	r
3			#	3	C	S	c	s			#	3	C	S	c	s
4			\$	4	D	T	d	t			\$	4	D	T	d	t
5			%	5	E	U	e	u			%	5	E	U	e	u
6			&	6	F	V	f	v			&	6	F	V	f	v
7			*	7	G	W	g	w			*	7	G	W	g	w
8			(	8	H	X	h	x			(	8	H	X	h	x
9			)	9	I	Y	i	y			)	9	I	Y	i	y
A			*	:	J	Z	j	z			*	:	J	Z	j	z
B			+	;	K	[	k	{			+	;	K	[	k	{
C			'	<	L	\	l				'	<	L	\	l	
D			-	=	M	]	m	}			-	=	M	]	m	}
E			.	>	N	^	n	~			.	>	N	^	n	~
F			/	?	O	_	o				/	?	O	_	o	

This character table is selected by the command **ESC t**.

**5.3 National Version EPSON Italic Character Table (part 1)**

	Character Code (Hex)											
	23	24	40	5B	5C	5D	5E	60	7B	7C	7D	7E
1: USA	#	\$	@	[	\	]	^	`	{		}	~
2: FRANCE	#	\$	à	E	ç	§	^	`	é	ù	è	¨
3: GERMANY	#	\$	§	Ä	Ö	Ü	^	`	ä	ö	ü	ß
4: U.K.	£	\$	@	[	\	]	^	`	{		}	~
5: DENMARK	#	\$	@	Æ	Ø	Å	^	`	æ	ø	å	~
6: SWEDEN	#	¤	É	Ä	Ö	Å	Ü	é	ä	ö	å	ü
7: ITALY	#	\$	@	E	\	é	^	ù	à	ò	è	ì
8: SPAIN	.	\$	@	i	Ñ	¿	^	`	¨	ñ	}	~
9: JAPAN	#	\$	@	[	¥	]	^	`	{		}	~
10: NORWAY	#	¤	É	Æ	Ø	Å	Ü	é	æ	ø	å	ü
11: DENMARK 2	#	\$	É	Æ	Ø	Å	Ü	é	æ	ø	å	ü
12: SPAIN 2	#	\$	á	i	Ñ	¿	é	`	í	ñ	ó	ú
13: LATIN AM.	#	\$	á	i	Ñ	¿	é	Ü	í	ñ	ó	ú
14: TURKEY	#	§	ı	Ç	Ö	Ö	Ü	™	ç	ö	ö	ü
15: LEGAL	#	\$	§	E	'	"	¶	`	©	®	†	™

### 5.3 National Version EPSON Italic Character Table (part 2)

	Character Code (Hex)											
	A3	A4	C0	DB	DC	DD	DE	E0	FB	FC	FD	FE
1: USA	#	\$	@	[	\	]	^	'	{		}	~
2: FRANCE	#	\$	à	É	ç	§	^	'	é	ù	è	”
3: GERMANY	#	\$	§	Ä	Ö	Ü	^	'	ä	ö	ü	ß
4: U.K.	£	\$	@	[	\	]	^	'	{		}	~
5: DENMARK	#	\$	@	Æ	Ø	Å	^	'	æ	ø	å	~
6: SWEDEN	#	¤	É	Ä	Ö	Å	Ü	é	ä	ö	å	ü
7: ITALY	#	\$	@	É	\	é	^	ù	à	ò	è	ì
8: SPAIN	.	\$	@	í	Ñ	¿	^	'	”	ñ	}	~
9: JAPAN	#	\$	@	[	¥	]	^	'	{		}	~
10: NORWAY	#	¤	É	Æ	Ø	Å	Ü	é	æ	ø	å	ü
11: DENMARK 2	#	\$	É	Æ	Ø	Å	Ü	é	æ	ø	å	ü
12: SPAIN 2	#	\$	á	í	Ñ	¿	é	'	í	ñ	ó	ú
13: LATIN AM.	#	\$	á	í	Ñ	¿	é	Ü	í	ñ	ó	ú
14: TURKEY	#	§	ı	Ç	Ö	Û	™	ç	ö	Û	ü	
15: LEGAL	#	\$	§	É	'	”	¶	'	©	®	†	™



**6 Code Table OCR-A**

	0	1	2	3	4	5	6	7
0	NUL	DLE	SP	0	@	P	+*	p
1	SOH	DC1	!	1	A	Q	a	q
2	STX	DC2	"	2	B	R	b	r
3	ETX	DC3	#	3	C	S	c	s
4	EOT	DC4	\$	4	D	T	d	t
5	ENQ	NAK	%	5	E	U	e	u
6	ACK	SYN	&	6	F	V	f	v
7	BEL	ETB	*	7	G	W	g	w
8	BS	CAN	(	8	H	X	h	x
9	HT	EM	)	9	I	Y	i	y
A	LF	SUB	*	:	J	Z	j	z
B	VT	ESC	+	;	K	[	k	{
C	FF	FS	¬	<	L	\	l	
D	CR	GR	-	=	M	]	m	}
E	SO	RS	.	>	N	^	n	*.
F	SI	US	/	?	O	<b>RR</b>	o	s

## 7. Code Pages for the Eastern European Countries (EE)

### 7.1 CODE PAGE 437 Greek

	2	3	4	5	6	7	8	9	A	B	C	D	E	F
0	␣	0	@	P	`	p	!	C	4	!	.	J	T	₤
1	!	1	A	Q	a	q	#	E	6	"	2	L	•	±
2	"	2	B	R	b	r	'	I	8	#	0	H	!	\$
3	#	3	C	S	c	s	)	K	μ	*	/	F	²	#
4	\$	4	D	T	d	t	+	M	<	1	)	B	^	!
5	%	5	E	U	e	u	-	O	>	I	3	?	£	"
6	&	6	F	V	f	v	/	Q	@	M	G	C	İ	÷
7	*	7	G	W	g	w	1	S	B	D	K	0	Û	.
8	(	8	H	X	h	x	3	"	D	@	9	P	d	E
9	)	9	I	Y	i	y	5	\$	F	<	6	-	é	£
A	*	:	J	Z	j	z	7	(	H	5	=	+	!	¥
B	+	;	K	[	k	{	9	*	J	7	;	\$	†	%
C	'	<	L	\	l		;	,	L	8	:	(	/	6
D	-	=	M	]	m	}	=	.	n	E	4	%	‡	²
E	.	>	N	^	n	~	?	0	P	A	>	'	?	#
F	/	?	O	_	o		A	2	R	,	N	&	Κ	

␣ = Space

**7.2 CODE PAGE 851 Greek**

	2	3	4	5	6	7	8	9	A	B	C	D	E	F
0	␣	0	@	P	`	p	Ç	[	^	!	.	l	.	-
1	!	1	A	Q	a	q	ü		ı	"	2	K	0	±
2	"	2	B	R	b	r	é	?	İ	#	0	M	2	L
3	#	3	C	S	c	s	â	ô	Û	*	/	O	4	n
4	\$	4	D	T	d	t	ä	ö	U	1	)	Q	6	P
5	%	5	E	U	e	u	à	κ	#	5	3	S	8	§
6	&	6	F	V	f	v	Á	û	'	7	A	"	μ	R
7	*	7	G	W	g	w	ç	ù	)	9	C	\$	<	,
8	(	8	H	X	h	x	ê	Ş	+	;	9	(	>	°
9	)	9	I	Y	i	y	ë	Ö	-	<	6	-	@	"
A	*	:	J	Z	j	z	è	Ü	/	5	=	+	B	T
B	+	;	K	[	k	{	ï	•	½	7	;	\$	D	Ü
C	'	<	L	\	l		î	£	1	8	:	(	F	Ý
D	-	=	M	]	m	}	†	ı	3	=	4	.	H	ñ
E	.	>	N	^	n	~	Ä	²	*	?	>	g	J	#
F	/	?	O	_	o		/	\	+	,	G	&	r	

␣ = Space

**7.3 CODE PAGE 928 Greek**

	2	3	4	5	6	7	8	9	A	B	C	D	E	F
0	␣	0	@	P	`	p	Ç	É		°	À	A	Ú	B
1	!	1	A	Q	a	q	ü	æ	<	±	!	C	"	D
2	"	2	B	R	b	r	é	Æ	'	²	#		\$	H
3	#	3	C	S	c	s	â	ô	£	³	'	E	(	F
4	\$	4	D	T	d	t	ä	ö		t	)	I	*	J
5	%	5	E	U	e	u	à	ò		ˆ	+	K	,	L
6	&	6	F	V	f	v	å	û	⚡	!	-	M	.	n
7	*	7	G	W	g	w	ç	ù	§	!	/	O	O	P
8	(	8	H	X	h	x	ê	ÿ	"	+	1	Q	2	R
9	)	9	I	Y	i	y	ë	Ö	©	/	3	S	4	T
A	*	:	J	Z	j	z	è	Ü	[	]	5	ï	6	^
B	+	;	K	[	k	{	ï	ø	*	+	7	ÿ	8	d
C	'	<	L	\	l		î	£	¬	?	9	•	µ	ï
D	-	=	M	]	m	}	ì	¥		½	;	!	<	Ù
E	.	>	N	^	n	~	Ä	.		κ	=	²	>	é
F	/	?	O	_	o		Å	f	!	Σ	?	⚡	@	

␣ = Space

**7.4 CODE PAGE 855 Cyri**

	2	3	4	5	6	7	8	9	A	B	C	D	E	F
0	␣	0	@	P	`	p	l	<	"	!	.	:	a	-
1	!	1	A	Q	a	q	k	Š	!	"	2	9	D	Z
2	"	2	B	R	b	r	f	•	\$	#	0	<	C	Y
3	#	3	C	S	c	s	e	Ž	#	*	/	;	F	2
4	\$	4	D	T	d	t	.	•	P	1	)	>	E	1
5	%	5	E	U	e	u	-	"	O	N	3	=	H	T
6	&	6	F	V	f	v	p	f	*	M	8	@	G	S
7	*	7	G	W	g	w	o	,	)	4	7	?	J	^
8	(	8	H	X	h	x	t	-	,	3	9	B	I	]
9	)	9	I	Y	i	y	s	-	+	<	6	-	O	V
A	*	:	J	Z	j	z	z	©	L	5	=	+	/	U
B	+	;	K	[	k	{	y	¨	K	7	;	\$	&	R
C	´	<	L	\	l			`	h	8	:	(	%	Q
D	-	=	M	]	m	}	{	_	g	Å	4	A	\	
E	.	>	N	^	n	~	•	X	*	Ä	>	b	[	#
F	/	?	O	_	o		€	W	+	,	¤	&	m	

␣ = Space

**7.5 CODE PAGE 866**

	2	3	4	5	6	7	8	9	A	B	C	D	E	F
0	␣	0	@	P	`	p	!	C	"	!	.	J	D	-
1	!	1	A	Q	a	q	#	E	\$	"	2	L	F	.
2	"	2	B	R	b	r	%	G	&	#	0	H	H	o
3	#	3	C	S	c	s	'	I	(	*	/	F	J	p
4	\$	4	D	T	d	t	)	K	*	1	)	B	L	{
5	%	5	E	U	e	u	+	M	,	I	3	?	N	
6	&	6	F	V	f	v	/	O	O	M	?	C	P	-
7	*	7	G	W	g	w	1	Q	2	D	K	0	R	-
8	(	8	H	X	h	x	3	S	4	@	9	P	T	°
9	)	9	I	Y	i	y	5	U	6	<	6	-	V	!
A	*	:	J	Z	j	z	7	W	8	5	=	+	\	!
B	+	;	K	[	k	{	9	Y	:	7	;	\$	Z	/
C	'	<	L	\	l		;	[	<	8	:	&	X	m
D	-	=	M	]	m	}	=	]	>	E	U	%	2	α
E	.	>	N	^	n	~	?	_	@	A	>	'	`	O
F	/	?	O	_	o		A	a	B	,	N	(	b	

␣ = Space

**7.6 CODE PAGE 869**

	2	3	4	5	6	7	8	9	A	B	C	D	E	F
0	␣	0	@	P	`	p		[	^	!	.	l	.	!
1	!	1	A	Q	a	q		{	ı	"	2	K	0	±
2	"	2	B	R	b	r		?	İ	#	0	M	2	L
3	#	3	C	S	c	s			Û	*	/	O	4	n
4	\$	4	D	T	d	t			!	1	)	Q	6	P
5	%	5	E	U	e	u		Ƙ	#	5	3	S	8	§
6	&	6	F	V	f	v	U	ÿ	'	7	A	"	µ	R
7	*	7	G	W	g	w		©	)	9	C	\$	<	^
8	(	8	H	X	h	x	!	Ş	+	;	9	(	>	°
9	)	9	I	Y	i	y	¬	²	-	<	6	-	@	"
A	*	:	J	Z	j	z	†	³	/	5	=	+	B	T
B	+	;	K	[	k	{	#	•	½	7	;	\$	D	U
C	'	<	L	\	l		r	£	1	8	:	(	F	Û
D	-	=	M	]	m	}	‡	ı	3	=	U	Ç	H	é
E	.	>	N	^	n	~	%	²	*	?	>	,	J	O
F	/	?	O	_	o		/	£	+	,	E	&	t	

␣ = Space

**7.7 CODE PAGE 852**

	2	3	4	5	6	7	8	9	A	B	C	D	E	F
0	␣	0	@	P	`	p	Ç	É	á	!	.	ð	Ó	-
1	!	1	A	Q	a	q	ü	²	í	"	²	Ð	ß	1
2	"	2	B	R	b	r	é	´	ó	#	0	Š	ô	3
3	#	3	C	S	c	s	â	ô	ú	*	/	Ë	¼	4
4	\$	4	D	T	d	t	ä	ö	€	1	)	<	½	?
5	%	5	E	U	e	u	ç	´	•	Á	3	À	Á	§
6	&	6	F	V	f	v	f	µ	ð	Â	{	í	Š	÷
7	*	7	G	W	g	w	ç	Ð	ñ	Æ		î	š	,
8	(	8	H	X	h	x	»	Ñ	'	Ô	9	•	Ë	°
9	)	9	I	Y	i	y	ë	Ö	"	<	6	-	Ú	"
A	*	:	J	Z	j	z	Ä	Ü	¬	5	=	+	Ë	"
B	+	;	K	[	k	{	Å	Ø	ï	7	;	\$	à	á
C	´	<	L	\	l		î	ù	„	8	:	(	ý	ì
D	-	=	M	]	m	}	î	°	õ	ò	u	ú	ý	í
E	.	>	N	^	n	~	Ä	x	*	ó	>	æ	û	#
F	/	?	O	_	o		,	...	+	,	¤	O	'	

␣ = Space



### 7.8 KAMENICKY

	2	3	4	5	6	7	8	9	A	B	C	D	E	F
0	Ť	0	@	P	`	p	„	É	á	!	.	J	"	/
1	!	1	A	Q	a	q	ü	ñ	í	"	2	L	\$	±
2	"	2	B	R	b	r	é	ð	ó	#	0	H	'	\$
3	#	3	C	S	c	s	(	ô	ú	*	/	F	J	#
4	\$	4	D	T	d	t	ä	ö	Á	1	)	B	3	!
5	%	5	E	U	e	u	Š	ó	À	I	3	?	F	"
6	&	6	F	V	f	v	Ø	ç	æ	M	G	C	μ	÷
7	*	7	G	W	g	w	...	Ú	ô	D	K	0	J	.
8	(	8	H	X	h	x	•	ý	š	@	9	P	M	°
9	)	9	I	Y	i	y	Œ	Ö	Í	<	6	-	1	•
A	*	:	J	Z	j	z	²	Ü	Ë	5	=	+	S	•
B	+	;	K	[	k	{	í	š	Ê	7	;	§!	*	/
C	'	<	L	\	l		μ	˘	¼	8	:	(	T	6
D	-	=	M	]	m	}	³	Ý	§	E	U	%	ø	²
E	.	>	N	^	n	~	Ä	Ì	*	A	>	'	,	€
F	/	?	O	_	o		Á	ť	+	,	N	&	1	

Ť = Space

## 7.9 ISO LATIN 2

	2	3	4	5	6	7		A	B	C	D	E	F
0	␣	0	@	P	`	p			°	Ê	Đ	Ě	ǫ
1	!	1	A	Q	a	q		€	•	Á	¼	á	½
2	"	2	B	R	b	r		7	℞	Â	À	â	Á
3	#	3	C	S	c	s		°	»	{	Ó		ó
4	\$	4	D	T	d	t		¤	'	Ä	Ô	ä	ô
5	%	5	E	U	e	u		´	µ	z	Ä	µ	Á
6	&	6	F	V	f	v		Đ	Ñ	,	Ö	f	ö
7	*	7	G	W	g	w		§	4	Ç	x	ç	÷
8	(	8	H	X	h	x		"	§	"	l	...	í
9	)	9	I	Y	i	y		Š	š	É	æ	é	ç
A	*	:	J	Z	j	z		Ö	õ	'	Ú	"	ú
B	+	;	K	[	k	{		Ø	Ù	Ë	à	ë	á
C	'	<	L	\	l			î	ï	Æ	Ü	•	ü
D	-	=	M	]	m	}		-	1	Í	Ý	í	ý
E	.	>	N	^	n	~		ö	ñ	Î	Ú	î	ù
F	/	?	O	_	o			ò	ó	Š	ß	<	!

␣ = Space

**7.10 MAZOVIA**

	2	3	4	5	6	7	8	9	A	B	C	D	E	F
0	Œ	0	@	P	`	p	Ç	'	î	!	.	J	"	/
1	!	1	A	Q	a	q	ü	"	ò	"	2	L	\$	±
2	"	2	B	R	b	r	é	»	ó	#	0	H	'	\$
3	#	3	C	S	c	s	â	ô	Ó	*	/	F	B	#
4	\$	4	D	T	d	t	ä	ö	½	1	)	B	3	!
5	%	5	E	U	e	u	à	,	¼	I	3	?	F	"
6	&	6	F	V	f	v	•	û	ï	M	G	C	µ	÷
7	*	7	G	W	g	w	ç	ù	é	D	K	0	J	.
8	(	8	H	X	h	x	ê	Đ	¿	@	9	P	M	°
9	)	9	I	Y	i	y	ë	Ö	1	<	6	-	1	!
A	*	:	J	Z	j	z	è	Ü	¬	5	=	+	S	!
B	+	;	K	[	k	{	ï	đ	½	7	;	\$	*	/
C	'	<	L	\	l		î	°	¼	8	:	(	4	6
D	-	=	M	]	m	}	f	Ÿ	i	E	U	%	ø	²
E	.	>	N	^	n	~	Ä	Ñ	*	A	>	'	,	€
F	/	?	O	_	o		€	f	+	,	N	&	1	

Œ = Space

## 7.11 CODE PAGE 437 HUN

	2	3	4	5	6	7	8	9	A	B	C	D	E	F
0	␣	0	@	P	`	p	Ç	É	á	!	.	J	"	/
1	!	1	A	Q	a	q	ü	æ	í	"	2	L	\$	±
2	"	2	B	R	b	r	é	Æ	ó	#	0	H	'	\$
3	#	3	C	S	c	s	â	Å	ú	*	/	F	B	#
4	\$	4	D	T	d	t	ä	ö	ñ	1	)	B	3	!
5	%	5	E	U	e	u	à	ó	Ñ	I	3	?	F	"
6	&	6	F	V	f	v	å	á	a	M	G	C	μ	÷
7	*	7	G	W	g	w	ç	Ú	Ä	D	K	0	J	.
8	(	8	H	X	h	x	ê	Ü	¿	@	9	P	M	°
9	)	9	I	Y	i	y	ë	Ö	1	<	6	-	1	!
A	*	:	J	Z	j	z	è	Ü	¬	5	=	+	S	!
B	+	;	K	[	k	{	ï	ø	½	7	;	\$	*	/
C	'	<	L	\	l		î	£	¼	8	:	(	4	6
D	-	=	M	]	m	}	³	¥	ì	E	U	%	ø	²
E	.	>	N	^	n	~	Ä	.-	*	A	>	'	,	€
F	/	?	O	_	o		Á	f	+	,	N	&	1	

␣ = Space

**7.12 CODE PAGE 852 SEE**

	2	3	4	5	6	7	8	9	A	B	C	D	E	F
0	␣	0	ø	P	ñ	p	Ç	É	á	!	.	ð	Ó	-
1	!	1	A	Q	a	q	ü	´	í	"	2	Ð	ß	1
2	"	2	B	R	b	r	é	µ	ó	#	0	Š	Ô	3
3	#	3	C	S	c	s	â	ô	ú	*	/	Ë	¼	4
4	\$	4	D	T	d	t	ä	ö	€	1	)	<	½	4
5	%	5	E	U	e	u	ç	´	•	Á	3	Ä	Á	§
6	&	6	F	V	f	v	f	µ	ð	Â	{	í	Š	÷
7	*	7	G	W	g	w	ç	Ð	ñ	Œ		î	š	,
8	(	8	H	X	h	x	»	Ñ	'	Ô	9	•	Ë	°
9	)	9	I	Y	i	y	ë	Ö	"	<	6	-	Ú	"
A	*	:	J	Z	j	z	Ä	Ü	¬	5	=	+	Ë	"
B	+	;	K	Š	k	š	Å	Ø	ï	7	;	š	à	á
C	´	<	L	Ð	l	ð	î	ù	„	8	:	(	ý	ì
D	-	=	M	,	m	f	î	°	õ	ò	u	ú	ý	í
E	.	>	N	„	n	...	Ä	x	*	ó	>	æ	ü	#
F	/	?	O	_	o		,	...	+	,	¤	O	'	

␣ = Space

**7.13 CODE PAGE 866 LAT**

	0	1	2	3	4	5	6	7	8	9	A	B	C	D	E	F
0	i	<	Œ	0	@	P	<	p	!	P	"	!	.	Š	D	•
1	(	=	!	1	A	Q	a	q	#	C	\$	"	2	L	F	'
2	)	;	"	2	B	R	b	r	%	T	&	#	0	...	H	Š
3	l	.	#	3	C	S	c	s	j	y	(	*	/	"	J	±
4	Ě	¶	\$	4	D	T	d	t	)	k	*	1	)	B	L	°
5	Ê	§	%	5	E	U	e	u	E	X	,	}	3	?	N	.
6	Í	-	&	6	F	V	f	v	/	O	O	M	~	g	P	¶
7	•	0	*	7	G	W	g	w	1	r	2	Ā	K	!	R	ñ
8	3	8	(	8	H	X	h	x	3	S	4	@	9	§	T	ö
9	•	9	)	9	I	Y	i	y	5	U	6	<	6	-	V	Æ
A	4	6	*	:	J	Z	j	z	7	W	8	5	=	+	X	!
B	%	7	+	;	K	[	k	{	9	Z	:	7	;	\$	Z	%
C	&	2	,	<	L	\	2		M	b	<	8	:	(	\	N
D	*	:	-	=	M	]	m	}	H	]	>	Ç	4	ã	^	š
E	+	>	.	>	N	^	n	~	O	_	@	A	>	â	`	#
F	'	?	/	?	O	_	o		A	a	B	,	N	&	b	

Œ = Space

7.14 WIN LAT2

	0	1	2	3	4	5	6	7	8	9	A	B	C	D	E	F
0	i	<	Œ	0	@	P	`	p				°	Ê	Đ	Ě	ř
1	(	=	!	1	A	Q	a	q		`	-	±	Á	¼	á	½
2	)	;	"	2	B	R	b	r	,	'	7	R	Â	À	â	Á
3	ì	.	#	3	C	S	c	s		?	°	»	{	Ó		ó
4	Ë	¶	\$	4	D	T	d	t	„	”	¤	'	Ä	Ô	ä	ô
5	Ê	§	%	5	E	U	e	u	ÿ	ç	€	µ	´	Ä	µ	Ä
6	í	_	&	6	F	V	f	v	†	-	‡	¶	,	Ö	f	ö
7	!	0	*	7	G	W	g	w	‡	—	§	?	Ç	x	ç	÷
8	3	8	(	8	H	X	h	x			"	š	„	ì	...	í
9	"	9	)	9	I	Y	i	y	‰	™	©	•	É	æ	é	ç
A	4	6	*	:	J	Z	j	z	Š	š	Ô	Õ	'	Ú	"	ú
B	%	7	+	;	K	[	k	{	<	>	«	»	Ë	à	ë	á
C	&	2	,	<	L	\	l		Đ	Ñ	¬	°	Œ	Ü	•	ü
D	*	:	-	=	M	]	m	}	Ø	‡	-	1	í	Ý	í	ý
E	+	>	.	>	N	^	n	~	ř	ñ	®	µ	î	Ú	î	ù
F	'	?	/	?	O	_	o		î	ï	ò	ó	Š	ß	đ	!

Œ = Space

## 8. Code Pages for the Eastern European Countries (EE2)

### 8.1 CP 771

	0	1	2	3	4	5	6	7	8	9	A	B	C	D	E	F
0	í	<		0	@	P	`	p	!	P	"	!	.	J	D	'
1	(	=	!	1	A	Q	a	q	#	C	\$	"	2	L	F	"
2	)	;	"	2	B	R	b	r	%	T	&	#	0	H	H	Ž
3	ĭ	.	#	3	C	S	c	s	j	y	(	*	/	F	J	•
4	Ě	¶	\$	4	D	T	d	t	)	k	*	1	)	B	L	"
5	Ê	§	%	5	E	U	e	u	E	X	,	I	3	?	N	©
6	Í	-	&	6	F	V	f	v	/	O	O	M	G	C	P	Š
7	•	0	*	7	G	W	g	w	1	r	2	D	K	0	R	š
8	3	8	(	8	H	X	h	x	3	S	4	@	9	P	T	ä
9	•	9	)	9	I	Y	i	y	5	U	6	<	6	-	V	â
A	4	6	*	:	J	Z	j	z	7	W	8	5	=	+	X	â
B	%	7	+	;	K	[	k	{	9	Z	:	7	;	\$	Z	ã
C	&	2	,	<	L	\	2		M	b	<	8	:	€	\	ö
D	*	:	-	=	M	]	m	}	H	]	>	E	4	•	^	ñ
E	+	>	.	>	N	^	n	~	O	_	@	A	>	"	`	O
F	'	?	/	?	O	_	o		A	a	B	,	N	...	b	



8.2 CP 773

	0	1	2	3	4	5	6	7	8	9	A	B	C	D	E	F
0	í	<		0	@	P	`	p	^	É	}	!	.	°	Ó	'
1	(	=	!	1	A	Q	a	q	ü	æ	¡	"	2	L	ß	"
2	)	;	"	2	B	R	b	r	é	Æ	Ó	#	0	0	Ö	Ž
3	ì	.	#	3	C	S	c	s	~	Ç	ò	*	/	.	¼	•
4	Ë	¶	\$	4	D	T	d	t	ä	ö	ó	1	)	1	õ	¨
5	Ê	§	%	5	E	U	e	u	•	Š	î	±	3	„	Õ	©
6	Í	-	&	6	F	V	f	v	á	ç	1	M	÷	³	µ	Š
7	•	0	*	7	G	W	g	w	f	Ö		?	K		½	š
8	3	8	(	8	H	X	h	x	»	×	©	¼	9	²	°	ä
9	•	9	)	9	I	Y	i	y	'	Ö	®	<	6	-	±	â
A	4	6	*	:	J	Z	j	z	î	Ü	¬	5	=	+	¶	â
B	%	7	+	;	K	[	k	{	ï	ø	½	7	;	§	•	ã
C	&	2	,	<	L	\	2		§	£	¼	8	:	€	Ã	ö
D	*	:	-	=	M	]	m	}	ò	Ø	°	¶	4	•	•	ñ
E	+	>	.	>	N	^	n	~	Ä	x	*	§	>	„	Ã	O
F	'	?	/	?	O	_	o		Á	¤	+	,	N	...	*	

## 8.3 CP 774

	0	1	2	3	4	5	6	7	8	9	A	B	C	D	E	F
0	í	<		0	@	P	`	p	Ç	É	á	!	.	•	"	/
1	(	=	!	1	A	Q	a	q	ü	æ	í	"	2	...	\$	±
2	)	;	"	2	B	R	b	r	é	Æ	ó	#	0	"	'	\$
3	İ	.	#	3	C	S	c	s	â	ô	ú	*	/	•	A	#
4	Ë	¶	\$	4	D	T	d	t	ä	ö	û	1	)	©	G	„
5	Ê	§	%	5	E	U	e	u	à	ò	ú	À	3	š	F	“
6	Í	-	&	6	F	V	f	v	â	û	ä	ˆ	ä	â	µ	0
7	•	0	*	7	G	W	g	w	ç	ù	ö	'	â	á	J	.
8	3	8	(	8	H	X	h	x	ê	ÿ	ı	Ž	9	ñ	M	E
9	•	9	)	9	I	Y	i	y	ë	Ö	1	<	6	-	1	@
A	4	6	*	:	J	Z	j	z	è	Ü	¬	5	=	+	S	.
B	%	7	+	;	K	[	k	{	ï	ç	½	7	;	\$	4	/
C	&	2	,	<	L	\	2		î	£	¼	8	:	&	4	6
D	*	:	-	=	M	]	m	}	ì	¥	¥	ˆ	4	%	ø	²
E	+	>	.	>	N	^	n	~	Ä	L	*	Š	>	'	,	O
F	'	?	/	?	O	_	o		Å	f	+	,	ò	(	1	

8.4 CP 775

	0	1	2	3	4	5	6	7	8	9	A	B	C	D	E	F
0	í	<		0	@	P	`	p	^	É	}	!	.	•	Ó	
1	(	=	!	1	A	Q	a	q	ü	æ	;	"	2	...	\$	±
2	)	;	"	2	B	R	b	r	é	Æ	ó	#	0	"	Æ	"
3	İ	.	#	3	C	S	c	s	~	Ç	ò	*	/	•	¼	¾
4	Ë	¶	\$	4	D	T	d	t	ä	ö	ó	1	)	©	õ	¶
5	Ê	§	%	5	E	U	e	u	ÿ	š	ı	À	3	š	Õ	§
6	Í	-	&	6	F	V	f	v	å	ç	"	"	ä	å	µ	÷
7	•	0	*	7	G	W	g	w	f	Đ		'	â	á	½	"
8	3	8	(	8	H	X	h	x	»	Ñ	©	Ž	9	ñ	°	E
9	•	9	)	9	I	Y	i	y	'	Ö	®	<	6	-	±	@
A	4	6	*	:	J	Z	j	z	î	Ü	¬	5	=	+	¶	.
B	%	7	+	;	K	[	k	{	ï	ø	½	7	;	\$	•	,
C	&	2	,	<	L	\	2		š	£	¼	8	:	&	Ã	³
D	*	:	-	=	M	]	m	}	ı	Ø	°	"	4	%	•	²
E	+	>	.	>	N	^	n	~	Ä	x	*	Š	>	'	Ã	O
F	'	?	/	?	O	_	o		Å	¤	+	,	ò	(	'	

## 8.5 BATIC RIM

	0	1	2	3	4	5	6	7	8	9	A	B	C	D	E	F
0	í	<		0	@	P	`	p				E	€	Š	•	š
1	(	=	!	1	A	Q	a	q		ó	„	±	“	¼	©	½
2	)	;	"	2	B	R	b	r	,	3	ø	²	}	Â	~	Ã
3	ì	.	#	3	C	S	c	s		?	£	³	,	Ó	f	ó
4	Ë	¶	\$	4	D	T	d	t	"	„	¤	“	Ä	Æ	ä	Ç
5	Ê	§	%	5	E	U	e	u	...	•	„	D	Å	Õ	å	õ
6	Í	-	&	6	F	V	f	v	†	-		¶	'	Ö	"	ö
7	•	O	*	7	G	W	g	w	‡	—	§	•	•	x	'	÷
8	3	8	(	8	H	X	h	x			Ø	ø	„	ä	...	å
9	•	9	)	9	I	Y	i	y	‰	™	©	¹	É	º	é	»
A	4	6	*	:	J	Z	j	z			Î	Ï	î	Ð	ï	Ñ
B	%	7	+	;	K	[	k	{	<	>	*	+	Ž	â	•	ã
C	&	2	,	<	L	\	2				¬	¼	š	à	>	á
D	*	:	-	=	M	]	m	}				½	º	ò	±	ó
E	+	>	.	>	N	^	n	~			®	¾	¡	ð	§	ñ
F	'	?	/	?	O	_	o				Æ	æ	¶	\$	•	

## Appendix D IBM ProPrinter Quick Reference

This appendix contains basic information on the IBM ProPrinter 4207, 4208 XL 24 Emulation commands supported in four Printer types:

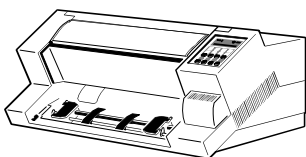

**Printer CI - 4040**

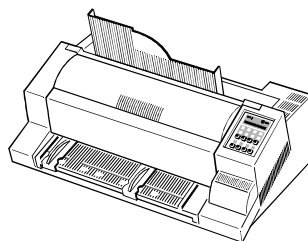

**Printer CI - 4050**

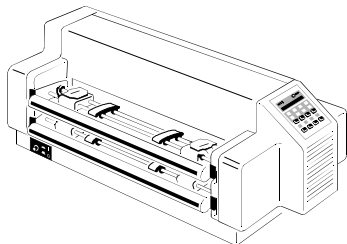

**Printer CI - 4070**

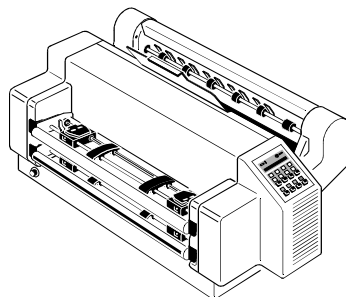

**Printer CI - 4080**

Some commands or parameters may be different for a specific **Printer type**. In those cases it will be indicated by the **PINTER NAME** to which pinter a command or parameter applies.

Characters used in control functions appear in monospaced type. Table 1 explains some of the conventions used.

A pair of numbers separated by a slash ( / ) character indicates Column/Row notation. This notation refers to the location of a character in a standard code table, such as ASCII. (example: 1/B = 1B is the hex-code for Escape)

Spaces appear between characters in sequence for clarity; they are not part of the format.

At the end of this chapter you will find a listing of the IBM ProPrinter Emulation commands classified by Hex Code and a Hex - Decimal conversion table.

The following conventions are used in the command listings:

---

**Table 1 Conventions**

---

ESC	Escape (1/B), introduces an escape sequence
Pn	Numeric parameter, or number of units that specify a distance or quantity pertaining to the escape sequence, control function or control string. Accepted values are 0...9999, may be preceded by + or -. If the parameter is in normal notation like "200" the programming in hex-code is according to a ASCII table. ("200" = 32,30,30 in hex). If the parameter must be programmed in hex-code the notation is with a slash. (1/A = 1A in hex-code)
v1...vn	A series of parameters pertaining to the escape sequence, control function or control string.
SP	Is standing for Space (hex 20)

---

**Table 2: Control Codes**

Column/Row	Mnemonic	Function
0/0	NUL	Null
0/8	BS	Backspace
0/9	HT	Horizontal Tab
0/A	LF	Line Feed
0/B	VT	Vertical Tab
0/C	FF	Form Feed
0/D	CR	Carriage Return
0/E	SO	Double Width Printing By Line
0/F	SI	Condensed Printing (17.1 cpi)
1/1	DC1	Select Printer
1/2	DC2	Select Pica (10 cpi)
1/3	DC3	Buffer Data Flow Control
1/4	DC4	Cancel Double Width Printing By Line
1/8	CAN	Cancel Buffer
1/B	ESC	Initiate Escape Sequence
2/0	SP	Space
7/F	DEL	Delete
1/B 6/A	ESC j	Set Printer Off Line
1/B 5/1 2/3	ESC Q	Deselect Printer
1/B 5/1 2/4	ESC Q	Deselect Printer

**Table 3: Vertical Form Handling**

Escape Sequence	Mnemonic Function
ESC 0	Set Line Space to $\frac{1}{8}$ "
ESC 1	Set Line Space to $\frac{7}{72}$ "
ESC 2	Start Variable Line Space
ESC 4	Set Top of Form
ESC 5 P1	Carriage Return Function P1 = 1 or 0/1: select CR + LF P1 = 0 or 0/0: cancel CR
ESC A P1	Set Line Space to $\frac{P1}{72}$ " ( $\frac{P1}{60}$ " ) P1 = $\frac{P1}{72}$ " lpi (non AGM) P1 = $\frac{P1}{60}$ " lpi (AGM) (P1 = 0/1...5/5) <b>Note:</b> Default = $\frac{12}{72}$ " or 6 lpi
ESC B <i>NUL</i>	Clear all Vertical Tabs
ESC B P1 P2 . . . P64 <i>NUL</i>	Set Vertical Tabs (Pn = 0/1...F/F)
ESC C P1	Set Form Length in Lines (P1 = 0/1...7/F)
ESC C <i>NUL</i> P1	Set Form Length in Inch (P1 = 0/1...1/6)
ESC N P1	Set Automatic Perforation Skip P1: is the number of lines from bottom of paper to skip. (P1 = 0/0...F/F)
ESC O	Cancel Automatic Perforation Skip
ESC [ \ <i>EOT NUL NUL NUL</i> P1 <i>NUL</i>	Set Line Space Unit EOT = 0/4 P1 = B/4 : select 1/180" P1 = D/8 : select 1/216" P1 = 0/0 : setting remains unchanged



**Table 3 (Cont.): Vertical Form Handling**

Escape Sequence	Mnemonic	Function
ESC ]		Reverse Line Feed
ESC ] > s <i>Native Command</i>	IF	Insert Form
ESC [ > P1 ; P2 ; P3 ; P4 s <i>Native Command</i>	SPSIF	Select Paper Source and Insert Form, Print Gap, Paper Exit, Cut-Mode (any parameter > or P may be skipped, see following alternative command sequences); > = Insert Form
ESC [ P1 s <i>Native Command</i>	SPS	Paper Source: P1 = 0 : Manual Feed **) P1 = 1 : ASF, Bin 1 *) P1 = 2 : ASF, Bin 2 *) P1 = 3 : ASF, Bin 3 *) P1 = 6 : upper Tractor ***) P1 = 7 : Tractor Feed (lower Tractor) P1 = 8 : ASF, Bins 1 or 2 *) P1 = 9 : ASF, Bins 2 or 3 *) P1 = 1 0 : ASF, Bins 1 or 2 or 3 *) P1 = 1 5 : upper and lower tractor ***)
ESC [ ; P2 s <i>Native Command</i>	AGC/PCC	Procedure: P2 = 0 : Automatic Gap Control P2 = 1 : Print Gap for 1-ply copy P2 = 2 : Print Gap for 2-ply copies P2 = 3 : Print Gap for 3-ply copies P2 = 4 : Print Gap for 4-ply copies P2 = 5 : Print Gap for 5-ply copies P2 = 6 : Print Gap for 6-ply copies

---

\*\* ) only **CI - 4040**, and **CI - 4050**

\* ) only **CI - 4050**

\*\*\* ) only **CI - 4070** and **CI - 4080**

**Table 3 (Cont.): Vertical Form Handling**

Escape Sequence	Mnemonic Function
ESC [ ; ; P3 s <i>Native Command</i>	Paper Exit: P3 = 0 : Paper Exit Stacker <b>***</b> ) P3 = 1 : Paper Exit Front Side <b>**</b> ) (confirmed by Start/Stop key) P3 = 2 : Paper Exit Front Side <b>**</b> ) (not confirmed by Start/Stop key, controlled by application) P3 = 3 : Batch output; rear side
ESC [ ; ; ; P4 s <i>Native Command</i>	Cut Mode On/Off: <b>****</b> ) P4 = 0 : Cut Mode Off P4 = 1 : Cut Mode On P4 = 2 : Cut on actual position (cutting edge is approximate 4 mm above the base of the actual line)

---

**\*\*\***) only **CI - 4050** and **CI - 4080**

**\*\***) only **CI - 4040**, and **CI - 4050**

**\*\*\*\***) only **CI - 4080**

**Table 4: Horizontal Form Handling and Printing Modes**

Escape Sequence	Function
ESC :	Select Elite (12 cpi)
ESC - P1	Cancel / Select Underline P1 = 0/0 cancel Underline Printing P1 = 0/1 set Underline Printing
ESC _ P1	Cancel / Select Overline Printing P1 = 0/0 cancel Overline Printing P1 = 0/1 set Overline Printing
ESC [ @ EOT NUL NUL NUL P1 P2	Double, Multiple -Width/ - Height Mode P1 controls line spacing (e.g. 0/x) and character height (e.g. x/0) P2 controls character width P1 = 0/x line spacing unchanged P1 = 1/x single line space P1 = 2/x double line space P1 = 3/x triple line space P1 = 4/x quadruple line space P1 = x/0 character height unchanged P1 = x/1 single character height P1 = x/2 double character height P1 = x/3 triple character height P1 = x/4 quadruple character height P2 = 0/0 character width unchanged P2 = 0/1 single character width P2 = 0/2 double character width P2 = 0/3 triple character width P2 = 0/4 quadruple character width
<b>Example:</b>	Coding to select "double line space", "double character height", and "double character width" in Hex: 1B 5B 40 04 00 00 00 22 02
ESC D NUL	Clear all Horizontal Tabs
ESC D P1 P2 ... P32 NUL	Set Horizontal Tabs (P1...P32 = 0/1...F/F)

**Table 4 (Cont.): Horizontal Form Handling and Printing Modes**

Escape Sequence	Function
ESC E	Select Emphasized Printing (bold)
ESC F	Cancel Emphasized Printing (bold)
ESC G	Select Double Strike Printing (bold)
ESC H	Cancel Double Strike Printing
ESC I P1	Select Character Mode P1 = 0/0 : Draft, 10 cpi P1 = 0/1 : Draft, Proportional P1 = 0/2 : Courier, 10 cpi P1 = 0/3 : Courier, Proportional P1 = 0/8 : Draft, 12 cpi P1 = 0/A : Courier, 12 cpi P1 = 1/0 : Draft, 17 cpi P1 = 1/2 : Courier, 17 cpi
ESC P P1	Cancel / Select Proportional Printing P1 = 0/0 or 0 : cancel Proportional P1 = 0/1 or 1 : select Proportional
ESC R	Restore Horizontal Tabs to Default
ESC S P1	Select Superscript/Subscript P1 = 0/0 or 0 : select Superscript P1 = 0/1 or 1 : select Subscript
ESC T	Cancel Superscript/Subscript
ESC U P1	Cancel / Select Unidirectional Printing P1 = 0/0 or 0 : cancel Unidirectional P1 = 0/1 or 1 : select Unidirectional

**Table 4 (Cont.): Horizontal Form Handling and Printing Modes**

Escape Sequence	Mnemonic	Function
ESC W P1		Cancel / Select Double Width P1 = 0/0 or 0 : cancel Double Width P1 = 0/1 or 1 : select Double Width
ESC X P1 P2		Set Left and Right Margins P1 : Left Margin P2 : Right Margin (Pn = 0/0...F/F)
ESC d P1 P2		Set Relative Horizontal Dot Position (P1 + P2 x 256)/120" (Pn = 0/0...F/F)
ESC <		Home Position of Printhead (left margin)
ESC ;		Set Left Margin at Current Position
ESC [ P1 SP r <i>Native Command</i>	SPQ	Select Print Quality LQ / NLQ P1 = 0 : LQ P1 = 1 : NLQ

**Table 4 (Cont.): Horizontal Form Handling and Printing Modes**

Escape Sequence	Mnemonic	Function
ESC [ P1 ; P2 x <i>Native Command</i>	CPL	Select Font and Character Pitch (parameter P1 or P2 may be skipped, see following alternative command sequences)
ESC [ P1 x <i>possible format of Native Command CPL</i>		P1 selects the font P1 = 0 or missing : Font is unchanged P1 = 1 : Data P1 = 2 : Roman P1 = 3 : San Serif P1 = 4 : Courier P1 = 5 : Prestige P1 = 6 : Script P1 = 7 : OCR B P1 = 8 : OCR A P1 = 9 : Orator-C P1 = 10 : Orator P1 = 11 : Data Large
ESC [ ; P2 x <i>possible format of Native Command CPL</i>		P2 selects the character pitch P2 = 0 or missing: Pitch is unchanged P2 = 1 : 10 cpi P2 = 2 : 12 cpi P2 = 3 : 15 cpi P2 = 4 : (proportional) P2 = 5 : proportional P2 = 6 : 14.4 cpi P2 = 7 : 18 cpi P2 = 8 : 17 cpi P2 = 9 : 20 cpi

**Table 5: Character Set Selection**

Escape Sequence	Mnemonic Function
ESC 6	Select Character Set 2
ESC 7	Select Character Set 1
ESC \ P1 P2	Print from All Character Set Number of codes = $(P1 + P2 * 256)$ (Pn = 0/0...F/F)
ESC ^ P1	Print Single Character from All Character Set P1 = Number of Char. Set or Code Page (Pn = 0/0...F/F)
ESC [ T n1 n2 NUL NUL P1 P2	Code Page Switching n1 = 4, n2 = 0 P1 P2 for Code-Page number, most significant byte first. P1 P2 1 181 : CP 437 U.S.A. 3 82 : CP 850 Multilingual 3 90 : CP 858 Multilingual + Euro 3 92 : CP 860 Portugal 3 95 : CP 863 French 3 97 : CP 865 Norway

**Table 6: Graphics Modes**

Escape Sequence	Mnemonic Function
ESC 3 P1	Set Line Space to $P1/_{216}$ " ( $P1/_{180}$ " $P1/_{216}$ lpi (non AGM), $P1/_{180}$ lpi (AGM) (P1 = 0/1...F/F)
ESC J P1	Perform $P1/_{216}$ " ( $P1/_{180}$ " Line Feed $P1/_{216}$ lpi (non AGM), $P1/_{180}$ lpi (AGM) (P1 = 0/0...F/F)
ESC K P1 P2 v1 . . . vn	Standard Density Graphics Mode (P1 + P2 * 256) = number of data (Pn = 0/0...F/F)
ESC L P1 P2 v1 . . . vn	Double Density Graphics Mode (P1 + P2 * 256) = number of data (Pn = 0/0...F/F)
ESC Y P1 P2 v1 . . . vn	Double Speed & Density Graphics Mode (P1 + P2 * 256) = number of data (Pn = 0/0...F/F)
ESC Z P1 P2 v1 . . . vn	Quadruple Density Graphics Mode (P1 + P2 * 256) = number of data (Pn = 0/0...F/F)



**Table 6 (Cont.):** Graphics Modes

Escape Sequence	Mnemonic Function
ESC [ g P1 P2 P3 v1 . . . vn	Select Various Graphics Modes (IBM) $P1 + P2 * 256 = \text{number of data bytes} + 1$ (P1,P2 = 0/0...F/F) v1 .. vn = binary data in hex code

*Parameter Table Graphic Density:*

P3	Graphic type	dots per column	max. of columns	hor. density ( dpi )	vert. density no AGM	vert. density AGM
0/0	Standard Density (K)	8	816	60	72	60
0/1	Double Density (L)	8	1632	120	72	60
0/2	2xDensity / 2xSpeed (Y)	8	1632	120	72	60 *)
0/3	Quadruple Density (Z)	8	3264	240	72	60 *)
0/8	Standard Density	24	816	60	180	180
0/9	Double Density	24	1632	120	180	180
0/B	Triple Density	24	2448	180	180	180
0/C	Hex Density	24	4896	360	180	180 *)

\*) *consecutive horizontal dots cannot be printed.*

**Example:** box 8x8 dots with center point 2x2 dots, standard density, 8 dots / column  
hex: 1B 5B 67 09 00 00 FF 81 81 99 99 81 81 FF

**Table 7: Further Control Sequences, supported by  
IBM Emulation Mode (Native Commands)**

Escape Sequence	Mnemonic	Function
ESC [	\$\$	Control String Introducer (CSI) for 'ESC ['
ESC	\$\$/	Control String Introducer (CSI) for 'ESC'
ESC * P1 P2 P3 v1 . . . vn		Select Various Graphics Modes P2 + P3 * 256 = number of columns (P2,P3 = 0/0...F/F) v1 .. vn = binary data in hex code

*Parameter Table Graphic Density:*

P1	Graphic type	dots per column	max. of columns	hor. density ( dpi )	vert. density no AGM	vert. density AGM	
0/0	Standard Density (K)	8	816	60	72	60	
0/1	Double Density (L)	8	1632	120	72	60	
0/2	2xDensity / 2xSpeed (Y)	8	1632	120	72	60	*)
0/3	Quadruple Density (Z)	8	3264	240	72	60	*)
0/4	CRT I	8	1088	80	72	60	
0/5	Plotter	8	979	72	72		
0/6	CRT II	8	1224	90	72	60	
0/B	Double Density Plotter	8	1958	144	72		*)
2/0	Standard Density	24	816	60	180	180	
2/1	Double Density	24	1632	120	180	180	
2/6	CRT III	24	1224	90	180	180	
2/7	Triple Density	24	2448	180	180	180	
2/8	Hex Density	24	4896	360	180	180	*)

\*) consecutive horizontal dots cannot be printed.

**Example:** box 8x8 dots with center point 2x2 dots, standard density, 8 dots / column  
hex: 1B 2A 00 08 00 FF 81 81 99 99 81 81 FF

**Table 7 (Cont.): Further Control Sequences, supported by  
IBM Emulation Mode (Native Commands)**

Escape Sequence	Mnemonic	Function
ESC [ P1 ; P2 w	SNVCT	<p>Set National Version and Code Table</p> <p>P1 = 1 - 15 national version depending on selected character set (see Appendix C Char. Set Tables)</p> <p>P2 = 3 digit code of the code table (see command SCT)</p> <p>P1 for national version <b>IBM SET 2:</b></p> <p>P1 = 1 : U.S.A  P1 = 2 : France  P1 = 3 : Germany  P1 = 4 : U.K.  P1 = 5 : Denmark  P1 = 6 : Sweden  P1 = 7 : Italy  P1 = 8 : Spain  P1 = 9 : Japan  P1 = 10 : Norway  P1 = 11 : Denmark 2  P1 = 12 : Spain 2  P1 = 13 : Latin AM  P1 = 14 : Turkey</p>
		<p>P1 for <b>IBM CODE PAGE:</b></p> <p>P1 = 1 : CP 437  P1 = 2 : CP 850  P1 = 3 : CP 860  P1 = 4 : CP 863  P1 = 5 : CP 865  P1 = 6 : CP 858</p>
		<p>P1 for <b>CODE PAGE EE:</b></p> <p>P1 = 1 : CP 437 GK  P1 = 2 : CP 851 GK  P1 = 3 : CP 928 GK  P1 = 4 : CP 855 CYRI  P1 = 5 : CP 866  P1 = 6 : CP 869  P1 = 7 : CP 852</p>
		<p>P1 for <b>CODE PAGE EE2:</b></p> <p>P1 = 1 : CP 771  P1 = 2 : CP 773  P1 = 3 : CP 774  P1 = 4 : CP 775  P1 = 5 : CP BALTIC RIM</p>
ESC [ ; P2 w	SCT	<p>Set Code Table</p> <p>P2 = 3 bit code of the code table</p> <p>P2 = 0 6 1 : IBM Set 1  P2 = 0 6 2 : IBM Set 2  P2 = 0 6 3 : IBM Code Page  P2 = 0 7 1 : EPSON Ext. G. C. T  P2 = 1 0 0 : CODE PAGES EE  P2 = 1 0 1 : CODE PAGES EE2</p>

**Table 7 (Cont.): Further Control Sequences, supported by  
IBM Emulation Mode (Native Commands)**

Escape Sequence	Mnemonic	Function
ESC [ P1 ; P2 SP r	SM #	Select Macro and Change Emulation P1 = 1: Macro 1 P1 = 2: Macro 2 P1 = 3: Macro 3 P1 = 4: Macro 4 P2 = 0: no change of emulation P2 = 1: EPSON Emulation P2 = 2: IBM ProPrinter Emulation P2 = 3: IBM ProPrinter AGM Emulation P2 = 4: EPSON Emulation
ESC M	RLF	Reverse Line Feed
ESC [ < s	EJF	Eject Form
ESC [ P1 ; P2 SP B	GSM	Graphic Size Modification P1 = 1 0 0 : normal height P1 = 2 0 0 : normal height P1 = 3 0 0 : normal height P1 = 4 0 0 : quadruple height P1 = max. <b>8 0 0</b> in steps of 100  P2 = 1 0 0 : normal width P2 = 2 0 0 : double width P2 = 3 0 0 : triple width P2 = 4 0 0 : quadruple width P2 = max. <b>8 0 0</b> in steps of 100  Graphic Size Modification for <b>DATA LARGE</b> P1 = 1 0 0 : normal height P2 = 1 0 0 : normal width P1 and P2 max. <b>9 9 0 0</b> in steps of 100
ESC [ P1 `	HPA	Set Horizontal Position Absolute P1 = print column (P1 = 0...9999)

**Table 7 (Cont.): Further Control Sequences, supported by  
IBM Emulation Mode (Native Commands)**

Escape Sequence	Mnemonic	Function
ESC [ P1 a	HPR	Set Horizontal Position Relative P1 = print column (P1 = 0...9999)
ESC [ P1 b	RPT	Repeat Character P1 = number of repetitions (P1 = 1...999)
ESC [ P1 d	VPA	Set Vertical Position Absolute P1 = 0 or 1: Top of Form / Top Margin P1 = 2... 9999: Vertical Line
ESC [ P1 e	VPR	Set Vertical Position Relative P1 = 0 or 1: moves the position one line P1 = 2... 9999: Vertical Line
ESC [ P1 g	TBC	Tabulation Clear P1 = 0: at active print pos. all tabs and margin marker, P1 = 3: all horizontal-, P1 = 4: all vertical tabs and margin marker
ESC [ P1 w	SNV	Set National Version P1 = 1 - 15 national version depending on selected character set (see Appendix C Character Set Tables)
ESC [ P1 {	LSL	Line Space Load P1 = 1, 2, 3, 4, 6, 8, 12, 16, 24, 48, 60, 72, 90, 144, 180, 360

**Table 7 (Cont.): Further Control Sequences, supported by  
IBM Emulation Mode (Native Commands)**

Escape Sequence	Mnemonic	Function
ESC [ P1 m	SGR	Set Graphic Rendition
		P1 = 0: default - no rendition or rendition reset
		P1 = 1: bold
		P1 = 3: italics
		P1 = 4: underline
		P1 = 9: crossed out or strike through printing
		P1 = 20: enlarged double width printing
		P1 = 21: double underline
		P1 = 22: bold reset
		P1 = 23: italics reset
		P1 = 24: underline reset
		P1 = 29: crossed out reset
		P1 = 30: black *)
		P1 = 31: orange *)
		P1 = 32: green *)
		P1 = 33: yellow *)
		P1 = 34: purple *)
		P1 = 35: magenta (red) *)
		P1 = 36: cyan (blue) *)
		P1 = 53: over lined
		P1 = 55: over lined reset

---

\*) only CI - 4050

**Table 7 (Cont.): Further Control Sequences, supported by  
IBM Emulation Mode (Native Commands)**

Escape Sequence	Mnemonic	Function
ESC [ ; P2 ; P3 ; P4 ; P5 ; P6 ; P7 SP z <i>BARCODE Programming</i>	BH	Barcode Header P2: Barcode typ P3: Height of barcode P4: Width of the thin bars P5: Width of the thin gaps P6: Ratio width to thin (bars/gaps) P7: Uni-directional or bi-directional printing 0 : or not programmed: means no changes 1 : uni-directional printing in LQ 2 : bi-directional printing in LQ 3 : uni-directional printing in NLQ 4 : bi-directional printing in NLQ
	<b>Note:</b>	A switch from uni-directional to bi-directional printing is only possible if the parameter <b>UNI-DIRECT.CMD</b> is set to <b>YES</b> via operator panel or ESC-sequence.
ESC [ ? 0 h	SMBC	Set Mode Barcode
ESC [ ? 0 l	RSBC	Reset Mode Barcode

Hex Code	Format	Page
00	Null	E-3
08	Backspace	E-3
09	Horizontal Tab	E-3
0A	Line Feed	E-3
0B	Vertical Tab	E-3
0C	Form Feed	E-3
0D	Carriage Return	E-3
0E	Select Double Width (one line)	E-3
0F	Select Condensed Mode (17,1 cpi)	E-3
11	Select Printer	E-3
12	Select Pica (10 cpi)	E-3
13	Buffer Data Flow Control	E-3
14	Cancel Double Width	E-3
18	Cancel Buffer	E-3
1B	Escape	E-3
20	Space	E-3
7F	Delete	E-3
1B 30	Set Line Space to $\frac{1}{8}$ "	E-4
1B 31	Set Line Space to $\frac{7}{72}$ "	E-4
1B 32	Start Variable Line Space	E-4
1B 34	Set Top Of Form	E-4
1B 36	Select Character Set 2	E-11
1B 37	Select Character Set 1	E-11
1B 3A	Select Elite (12 cpi)	E-7
1B 3B	Set Left Margin at Current	E-9
1B 3C	Home Position of Printhead	E-9
1B 45	Select Emphasized (bold)	E-8
1B 46	Cancel Emphasized	E-8
1B 47	Select Double Strike (bold)	E-8
1B 48	Cancel Double Strike	E-8
1B 4D	Reverse Line Feed	E-16
1B 4F	Cancel Automatic Perforation Skip	E-4
1B 52	Restore Horizontal Tabs to Default	E-8



Hex Code	Format	Page
1B 54	Cancel Superscript/Subscript	E-8
1B 5D	Reverse Line Feed	E-5
1B 6A	Set Printer Off Line	E-3
24 24	Control String Introducer for ESC [	E-14
24 24 2F	Control String Introducer for ESC	E-14
1B 2D 00 / 1B 2D 01	Cancel / Select / Underline	E-7
1B 33 P <sub>1</sub>	Set Line Space to $P^1/_{216}$ " ( $P^1/_{180}$ " )	E-12
1B 35 01 / 1B 35 00	Carriage Return Function	E-4
1B 41 P <sub>1</sub>	Set Line Space to $P^1/_{72}$ " ( $P^1/_{60}$ " )	E-4
1B 42 00	Clear all Vertical Tabs	E-4
1B 43 P <sub>1</sub>	Set Form Length in Lines	E-4
1B 44 00	Clear all Horizontal Tabs	E-7
1B 49 P <sub>1</sub>	Select Character Mode	E-8
1B 4A P <sub>1</sub>	Perform $P^1/_{216}$ " ( $P^1/_{180}$ " ) Line feed	E-12
1B 4E P <sub>1</sub>	Set Skip Over Perforation	E-4
1B 50 00 / 1B 50 01	Cancel / Select Proportional	E-8
1B 51 23 or 1B 51 24	Deselect Printer	E-3
1B 53 00 / 1B 53 01	Select Superscript / Subscript	E-8
1B 55 00 / 1B 55 01	Cancel / Select Unidirectional Printing	E-8
1B 57 00 / 1B 57 01	Cancel / Select Double Width	E-9
1B 5E P <sub>1</sub>	Single Character from All Char. Set	E-11
1B 5F 00 / 1B 5F 01	Cancel / Select Overline	E-7
1B 2A P <sub>1</sub> P <sub>2</sub> P <sub>3</sub> data	Select Various Graphics Modes	E-14
1B 42 P <sub>1</sub> ....P <sub>64</sub> 00	Set Vertical Tabs	E-4
1B 43 00 P <sub>1</sub>	Set Form Length in Inches	E-4
1B 44 P <sub>1</sub> ...P <sub>n</sub> 00	Set Horizontal Tabs	E-7
1B 4B P <sub>1</sub> P <sub>2</sub> data	Standard Density Graphics Mode	E-12
1B 4C P <sub>1</sub> P <sub>2</sub> data	Double Density Graphics Mode	E-12
1B 50 21 3B 3B P <sub>2</sub> 1B 5C	Delete Font by Font Number	E-19
1B 50 21 P <sub>1</sub> 3B 3B 1B 5C	Delete Font by Parameter	E-19
1B 50 21 P <sub>1</sub> 3B <i>le</i> 3B <i>Code</i> 1B 5C	Load Matrix Font	E-19
1B 58 P <sub>1</sub> P <sub>2</sub>	Set Left and Right Margins	E-9

Hex Code	Format	Page
1B 59 P <sub>1</sub> P <sub>2</sub> data	Double Speed & Double Density Graphics Mode	E-12
1B 5A P <sub>1</sub> P <sub>2</sub> data	Quadruple density Graphics Mode	E-12
1B 5B 3B P <sub>2</sub> 73	AGC / PCC Procedure	E-5
1B 5B 3B P <sub>2</sub> 77	Set Code Table	E-15
1B 5B 3B P <sub>2</sub> 3B P <sub>3</sub> 3B P <sub>4</sub> 3B P <sub>5</sub> 3B P <sub>6</sub> 3B P <sub>7</sub> 20 7A	Barcode Header	E-20
1B 5B 3C 73	Eject Form	E-16
1B 5B 3E 73	Insert Form	E-5
1B 5B 3E P <sub>1</sub> 3B P <sub>2</sub> 3B P <sub>3</sub> 3B P <sub>4</sub> 73	Select Paper Source and Insert Form	E-5
1B 5B 3F 30 68	Set Mode Barcode	E-20
1B 5B 3F 30 6C	Reset Mode Barcode	E-20
1B 5B 40 04 00 00 00 P <sub>1</sub> P <sub>2</sub>	Double, Multiple -Width/-Height Mode	E-7
1B 5B 5C 04 00 00 00 P <sub>1</sub> 00	Select Line Space Unit	E-4
1B 5B 67 P <sub>1</sub> P <sub>2</sub> P <sub>3</sub> data	Select Various Graphics Modes (IBM)	E-13
1B 5B P <sub>1</sub> 20 58	Select Print Quality LQ / NLQ	E-9
1B 5B P <sub>1</sub> 3B P <sub>2</sub> 20 72	Select Macro and Change Emulation	E-16
1B 5B P <sub>1</sub> 3B P <sub>2</sub> 20 42	Graphic Size Modification	E-16
1B 5B P <sub>1</sub> 3B P <sub>2</sub> 77	Set National Version and Code Table	E-15
1B 5B P <sub>1</sub> 3B P <sub>2</sub> 78	Select Font and Character Pitch	E-10
1B 5B P <sub>1</sub> 60	Set Horizontal Position Absolute	E-16
1B 5B P <sub>1</sub> 61	Set Horizontal Position Relative	E-16
1B 5B P <sub>1</sub> 62	Repeat Character	E-16
1B 5B P <sub>1</sub> 64	Set Vertical Position Absolute	E-17
1B 5B P <sub>1</sub> 65	Set Vertical Position Relative	E-17
1B 5B P <sub>1</sub> 67	Tabulation Clear	E-17
1B 5B P <sub>1</sub> 6D	Set Graphic Rendition	E-18
1B 5B P <sub>1</sub> 73	Select Paper Source	E-5
1B 5B P <sub>1</sub> 77	Set National Version	E-17
1B 5B P <sub>1</sub> 7B	Line Space Load	E-17
1B 5C P <sub>1</sub> P <sub>2</sub>	Print from All Character Set	E-11
1B 64 P <sub>1</sub> P <sub>2</sub>	Set Relative Horizontal Dot Position	E-9

**Hex - Decimal Conversion Table**

	0	1	2	3	4	5	6	7	8	9	A	B	C	D	E	F
0	0	16	32	48	64	80	96	112	128	144	160	176	192	208	224	240
1	1	17	33	49	65	81	97	113	129	145	161	177	193	209	225	241
2	2	18	34	50	66	82	98	114	130	146	162	178	194	210	226	242
3	3	19	35	51	67	83	99	115	131	147	163	179	195	211	227	243
4	4	20	36	52	68	84	100	116	132	148	164	180	196	212	228	244
5	5	21	37	53	69	85	101	117	133	149	165	181	197	213	229	245
6	6	22	38	54	70	86	102	118	134	150	166	182	198	214	230	246
7	7	23	39	55	71	87	103	119	135	151	167	183	199	215	231	247
8	8	24	40	56	72	88	104	120	136	152	168	184	200	216	232	248
9	9	25	41	57	73	89	105	121	137	153	269	185	201	217	233	249
A	10	26	42	58	74	90	106	122	138	154	170	186	202	218	234	250
B	11	27	43	59	75	91	107	123	139	155	171	187	203	219	235	251
C	12	28	44	60	76	92	108	124	140	156	172	188	204	220	236	252
D	13	29	45	61	77	93	109	125	141	157	173	189	205	221	237	253
E	14	30	46	62	78	94	110	126	142	158	174	190	206	222	238	254
F	15	31	47	63	79	95	111	127	143	159	175	191	207	223	239	255

## Appendix E EPSON LQ 2550 and ESC/P2 Quick Reference

This appendix contains basic information on the EPSON LQ 2550 Printer Emulation commands supported in four Printer types:

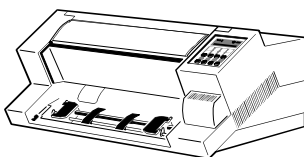

Printer CI - 4040

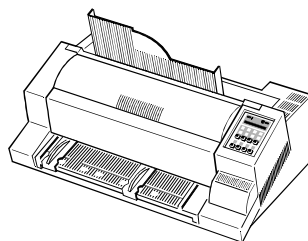

Printer CI - 4050

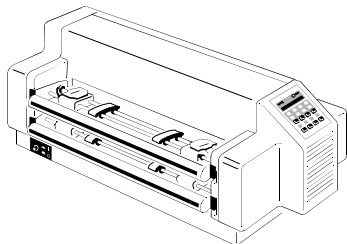

Printer CI - 4070

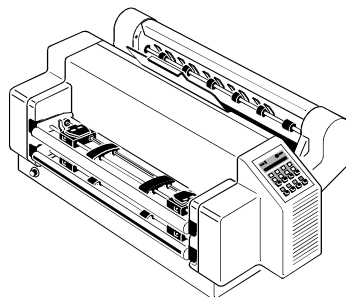

Printer CI - 4080

Some commands or parameters may be different for a specific **Printer type**. In those cases it will be indicated by the **PINTER NAME** to which pinter a command or parameter applies.

Characters used in control functions appear in monospaced type. Table 1 explains some of the conventions used.

A pair of numbers separated by a slash ( / ) character indicates Column/Row notation. This notation refers to the location of a character in a standard code table, such as ASCII. (example: 1/B = 1B is the hex-code for Escape)

Spaces appear between characters in sequence for clarity; they are not part of the format.

At the end of this chapter you will find a listing of the EPSON LQ 2550 Emulation commands classified by Hex Code and a Hex - Decimal conversion table.

The following conventions are used in the command listings:

---

### Table 1 Conventions

---

ESC	Escape (1/B), introduces an escape sequence
P1	Numeric parameter, or number of units that specify a distance or quantity pertaining to the escape sequence, control function or control string. Accepted values are 0...9999, may be preceded by + or -. If the parameter is in normal notation like "200" the programming in hex-code is according to a ASCII table. ("200" = 32,30,30 in hex). If the parameter must be programmed in hex-code the notation is with a slash. (1/A = 1A in hex-code)
v1...vn	A series of parameters pertaining to the escape sequence, control function or control string.
SP	Is standing for Space (hex 20)

---

**Table B-2: Control Codes**

Column/Row	Mnemonic	Function
0/0	NUL	Null
0/8	BS	Backspace
0/9	HT	Horizontal Tab
0/A	LF	Line Feed
0/B	VT	Vertical Tab
0/C	FF	Form Feed
0/D	CR	Carriage Return
0/E	SO	Double Width Printing By Line
0/F	SI	Condensed Printing
1/1	DC1	Select Printer
1/2	DC2	Select Pica (10 cpi)
1/3	DC3	Deselct Printer
1/4	DC4	Cancel Double Width Printing By Line
1/8	CAN	Cancel Buffer
1/B	ESC	Initiate Escape Sequence
2/0	SP	Space
7/F	DEL	Delete

**Table B-3: Terminal Management**

Escape Sequence	Mnemonic	Function
ESC @		Initialize Printer
ESC =		Set Most Significant Bit to 0
ESC >		Set Most Significant Bit to 1
ESC #		Cancel Most Significant Bit Control

**Table B-4: Vertical Form Handling**

Escape Sequence	Mnemonic Function
ESC 0	Set Line Space to $\frac{1}{8}$ "
ESC 2	Set Line Space to $\frac{1}{6}$ "
ESC 3 P1	Set Line Space to $\frac{P1}{180}$ " (P1 = 0...255)
ESC + P1	Set Line Space to $\frac{P1}{360}$ " (P1 = 0/0...F/F)
ESC A P1	Set Line Space to $\frac{P1}{60}$ " (P1 = 0/0...0/F)
ESC B <i>NUL</i>	Clear Vertical Tabs
ESC B P1 P2 ... P16 <i>NUL</i>	Set Vertical Tabs (P1...P16 = 0/1...F/F)
ESC C P1	Set Form Length in Lines (P1 = 0/1...F/F)
ESC C <i>NUL</i> P1	Set Form Length in Inches (P1 = 0/1...0/C)
ESC J P1	Perform $\frac{P1}{180}$ " Line Feed (P1 = 0/0...F/F)
ESC N P1	Set Automatic Perforation Skip P1 is the number of lines from bottom of paper to skip. (P1 = 0/1...7/F)
ESC O	Cancel Automatic Perforation Skip
ESC b P1 P2 .. P16 <i>NUL</i>	Set Vertical Tabs in Channel P1 P1 = 0/0 .. 0/7 : channel 0 - 7 P2..P16 = line number (P2..P16 = 0/1...F/F)
ESC b P1 <i>NUL</i>	Clear all Tabs in Channel P1 P1 = 0/0 .. 0/7 : channel 0 - 7
ESC j P1	Perform $\frac{P1}{180}$ " Reverse Line Feed (P1 = 0/0...F/F)
ESC / P1	Select Vertical Tab Channel P1 = 0/0 .. 0/7 : channel 0 .. 7

**Table B-4: (Cont.) Vertical Form Handling**

Escape Sequence	Mnemonic	Function
ESC <i>EMP</i> 1		Form Feed and ASF Control *) <i>EM</i> = 1/9 P1 = 0/1 or 1: ASF Bin 1 P1 = 0/2 or 2: ASF Bin 2 P1 = 0/3 or 3: ASF Bin 3 P1 = 8/2 or R: (5/2) eject sheet
ESC [ > P1 ; P2 ; P3 ; P4 s <i>Native Command</i>	SPSIF	Select Paper Source and Insert Form, Print Gap, Paper Exit, Cut-Mode (any parameter > or P1 to P4 may be skipped, see following alternative command sequences); > = Insert Form
ESC [ P1 s <i>Native Command</i>	SPS	Paper Source: P1 = 0 : Manual Feed **) P1 = 1 : ASF, Bin 1 *) P1 = 2 : ASF, Bin 2 *) P1 = 3 : ASF, Bin 3 *) P1 = 6 : upper Tractor ***) P1 = 7 : Tractor Feed (lower Tractor) P1 = 8 : ASF, Bins 1 or 2 *) P1 = 9 : ASF, Bins 2 or 3 *) P1 = 1 0 : ASF, Bins 1 or 2 or 3 *) P1 = 1 5 : upper and lower tractor ***)
ESC [ ; P2 s <i>Native Command,</i>	AGC/PCC	Print Gap Control: P2 = 0 : Automatic Gap Control P2 = 1 : Print Gap for 1-ply copy P2 = 2 : Print Gap for 2-ply copies P2 = 3 : Print Gap for 3-ply copies P2 = 4 : Print Gap for 4-ply copies P2 = 5 : Print Gap for 5-ply copies P2 = 6 : Print Gap for 6-ply copies

\*) only **CI - 4050**\*\*) only **CI - 4040**, and **CI - 4050**\*\*\*) only **CI - 4070** and **CI - 4080**



**Table B-4: (Cont.) Vertical Form Handling**

Escape Sequence	Mnemonic Function
ESC [ ; ; P3 s <i>Native Command</i>	Paper Exit: P3 = 0 : Paper Exit Stacker <b>***</b> ) P3 = 1 : Paper Exit Front Side <b>*)</b> (confirmed by Start/Stop key) P3 = 2 : Paper Exit Front Side <b>*)</b> (not confirmed by Start/Stop key, controlled by application) P3 = 3 : Batch output; rear side
ESC [ ; ; ; P4 s <i>Native Command</i>	Cut Mode On/Off: <b>****</b> ) P4 = 0 : Cut Mode Off P4 = 1 : Cut Mode On P4 = 2 : Cut on actual position (cutting edge is approximate 4 mm above the base of the actual line)

---

**\*\*\***) only **CI - 4050** and **CI - 4080**

**\*)** only **CI - 4040** and **CI - 4050**

**\*\*\*\***) only **CI - 4080**

**Table B-5: Horizontal Form Handling and Printing Modes**

Escape Sequence	Function
ESC SO	Select Double Width for One Line
ESC SI	Select Condensed 10 cpi -> 17 cpi 12 cpi -> 20 cpi 15 cpi -> 15 cpi (unchanged) proportional -> proportional cond.
ESC SP P1	Select Intercharacter Space Unit 1/120" for DRAFT (P1 = 0/0...7/F) Unit 1/180" for NLQ/LQ (P1 = 0/0...7/F)
ESC ! P1	Select Multiple Print Mode P1 selects: Bit0 = 0 : 10 cpi (Pica) Bit0 = 1 : 12 cpi (Elite) Bit1 = 1 : proportional Bit2 = 1 : Condensed Bit3 = 1 : Emphasized Bit4 = 1 : Double Strike Bit5 = 1 : Double Width Bit6 = 1 : Italics Bit7 = 1 : Underline
ESC \$ P1 P2	Set Absolute Horizontal Position $(P1 + P2 * 256) * \frac{1}{60}"$ (P1 = 0/0...F/F) (P2 = 0/0...0/3)
ESC \ P1 P2	Set Relative Horizontal Position Draft: $(P1 + P2 * 256) * \frac{1}{120}"$ (P1 = 0/0...F/F) (P2 = 0/0...0/6) NLQ/LQ: $(P1 + P2 * 256) * \frac{1}{180}"$ (P1 = 0/0...F/F) (P2 = 0/0...0/9)
ESC % P1	Select Standard / User Defined Character Set P1 = 0/0 : Standard Character Set P1 = 0/1 : User Defined Character Set

**Table B-5 (Cont.): Horizontal Form Handling and Printing Modes**

Escape Sequence	Function
ESC & NUL P1 P2 P3 P4 P5 v1 .. vn	Define User Defined Characters P1 = first code table position (P1 = 0/0...P2) P2 = last code table position (P2 = P1...7/F) P3 = front space (P3 = 0/0...5/0) P4 = body length Draft: (P4 = 0/0...0/F) LQ: (P4 = 0/0...2/5) P5 = rear space (P5 = 0/0...5/0) v1 .. vn = binary data in hex (vn = 0/0...F/F)

- Notes:**
- This Command defines one or more characters in a RAM character table.
  - All User Defined Characters are erased when the printer is switched off.
  - Set the Interface Buffer to 1k or 8K (max 50 defined char in LQ, 128 in draft), or use a RAM card for up to 128 User Defined Characters in LQ.
  - Set maximum every second dot to "1" in a horizontal line !
  - User Defined Characters can be defined in four different print modes:  
 resolution (vertical x horizontal)
 

Normal Size with Draft:	24 x 15
Normal Size with LQ / proport.:	24 x 37
Sub-/ Superscript with Draft:	16 x 15
Sub-/ Superscript with LQ / proport.:	16 x 37
  - The characters can only be activated in the same mode as defined.
  - The character layout is coded in three bytes (24 bit vertical) or two bytes (16 bit vertical) per column, top to bottom.
  - To print the character change to the User Defined Character Set with ESC % .

**Example:** vertical box, normal size with draft at code table position "41"  
 (P3=8, P4=5, P5=8)

hex: 1B 26 00 41 41 08 05 08 FF FF FF 00 00 00 80 00 01 00 00 00 FF FF FF

**Table B-5: (Cont.) Horizontal Form Handling and Printing Modes**

Escape Sequence	Function
ESC ( - P1 P2 P3 P4 P5	Select Line Marking P1 = 0/3 (fixed value) P2 = 0/0 (fixed value) P3 = 0/1 (fixed value) P4 = 0/1 : underline P4 = 0/2 : strike through P4 = 0/3 : overscore P5 = 0/0 : cancel score line selected by P4  P5 = 0/1 : single continuous line P5 = 0/2 : double continuous line P5 = 0/5 : single broken line P5 = 0/6 : double broken line
ESC 4	Set Italics
ESC 5	Cancel Italics
ESC <	Select Unidirectional Mode (one line)
ESC : NUL P1 NUL	Copy ROM Character Set to RAM P1 = 0/0 : S. ROMAN P1 = 0/1 : L. GOTHIC P1 = 0/2 : COURIER P1 = 0/3 : PRESTIGE P1 = 0/4 : SCRIPT P1 = 0/5 : OCR-B P1 = 0/6 : OCR-A P1 = 0/7 : ORATOR-C P1 = 0/8 : ORATOR
ESC - P1	Underline Printing P1 = 0/1 : set Underline Printing P1 = 0/0 : cancel Underline Printing
ESC D NUL	Clear Horizontal Tabs

**Table B-5: (Cont.) Horizontal Form Handling and Printing Modes**

Escape Sequence	Function
ESC D P1 P2 . . . P32 <i>NUL</i>	Set Horizontal Tabs P1 ... P32 = tab position (Pn = 0/1..F/F)
ESC E	Select Emphasized Printing (bold)
ESC F	Cancel Emphasized Printing
ESC G	Select Double Strike Printing (bold)
ESC H	Cancel Double Strike Printing
ESC M	Select Elite (12 cpi)
ESC P	Select Pica (10 cpi)
ESC Q P1	Set Right Margin (P1 = 0/3 ... F/F)
ESC S P1	Select Superscript/Subscript P1 = 0/0 or 3/0 : select Superscript P1 = 0/1 or 3/1 : select Subscript
ESC T	Cancel Superscript/Subscript
ESC U P1	Cancel/Select Unidirectional Printing P1 = 0/0 or 3/0 : cancel Unidirectional P1 = 0/1 or 3/1 : select Unidirectional
ESC W P1	Cancel/Select Double Width P1 = 0/0 or 3/0 : cancel Double Width P1 = 0/1 or 3/1 : select Double Width
ESC a P1	Select Justification P1 = 0/0 : select left justification P1 = 0/1 : center between margins P1 = 0/2 : select right justification P1 = 0/3 : select full justification

**Table B-5: (Cont.) Horizontal Form Handling and Printing Modes**

Escape Sequence	Function
ESC g	Select Pitch 15 cpi
ESC k P1	Select Font P1 = 0/0 : ROMAN P1 = 0/1 : SAN SERIF P1 = 0/2 : COURIER P1 = 0/3 : PRESTIGE P1 = 0/4 : SCRIPT P1 = 0/5 : OCR-B P1 = 0/6 : OCR-A P1 = 0/7 : ORATOR-C P1 = 0/8 : ORATOR P1 = 1/1 : DATA LARGE
ESC l P1	Set Left Margin (P1 = 0/0...F/C)
ESC p P1	Cancel/Select Proportional P1 = 0/0 or 3/0 : cancel proportional P1 = 0/1 or 3/1 : select proportional
ESC q P1	Select Character Style P1 = 0/0 : normal style P1 = 0/1 : outline P1 = 0/2 : shadow P1 = 0/3 : outline + shadow
ESC r P1	Select Printing Colour *) P1 = 0/0 : Black P1 = 0/1 : Magenta P1 = 0/2 : Cyan P1 = 0/3 : Violet P1 = 0/4 : Yellow P1 = 0/5 : Red P1 = 0/6 : Green

---

\*) only **CI - 4050**

**Table B-5: (Cont.) Horizontal Form Handling and Printing Modes**

Escape Sequence	Mnemonic	Function
ESC w P1		Cancel/Select Double Height P1 = 0/0 or 3/0 : cancel P1 = 0/1 or 3/1 : select
ESC x P1		Select Character Quality P1 = 0/0 or 3/0 : select Draft P1 = 0/1 or 3/1 : select LQ or NLQ dep. on set-up
ESC [ P1 ; P2 <i>SPB</i> <i>Native Command,</i>	GSM	Graphic Size Modification P1 = 100 : normal height P1 = 200 : double height P1 = 300 : triple height P1 = 400 : quadruple height P1 = max. <b>800</b> in steps of 100  P2 = 100 : normal width P2 = 200 : double width P2 = 300 : triple width P2 = 400 : quadruple width P2 = max. <b>800</b> in steps of 100  Graphic Size Modification for <b>DATA LARGE</b> P1 = 100 : normal height P2 = 100 : normal width P1 and P2 max. <b>9900</b> in steps of 100

**Table B-5: (Cont.) Horizontal Form Handling and Printing Modes**

Escape Sequence	Mnemonic	Function
ESC [ P1 ; P2 x <i>Native Command,</i>	CPL	Select Font and Character Pitch (any parameter P1 or P2 may be skipped, see following alternative command sequences)
ESC [ P1 x <i>possible format of Native Command CPL</i>		P1 selects the font: P1 = 0 or missing : Font is unchanged P1 = 1 : DATA P1 = 2 : ROMAN P1 = 3 : SAN SERIF P1 = 4 : COURIER P1 = 5 : PRESTIGE P1 = 6 : SCRIPT P1 = 7 : OCR B P1 = 8 : OCR A P1 = 9 : ORATOR-C P1 = 10 : ORATOR P1 = 11 : DATA LARGE
ESC [ ; P2 x <i>possible format of Native Command CPL</i>		P2 selects the character pitch: P2 = 0 or missing : Pitch is unchanged P2 = 1 : 10 cpi P2 = 2 : 12 cpi P2 = 3 : 15 cpi P2 = 5 : proportional P2 = 6 : 14.4 cpi P2 = 7 : 18 cpi P2 = 8 : 17.1 cpi P2 = 9 : 20 cpi



**Table B-6: Graphics Modes**

Escape Sequence	Function
ESC ? K P1	Reassign Graphics Mode K <sup>1)</sup> Standard Density, 8 dpc
ESC ? L P1	Reassign Graphics Mode L <sup>1)</sup> Double Density, 8 dot per column
ESC ? Y P1	Reassign Graphics Mode Y <sup>1)</sup> Double Density & -Speed, 8 dot per col.
ESC ? Z P1	Reassign Graphics Mode Z <sup>1)</sup> Quadruple Density, 8 dot per column
ESC K P2 P3 v1 . . . vn	Standard Density Graphics Mode <sup>1)</sup>
ESC L P2 P3 v1 . . . vn	Double Density Graphics Mode <sup>1)</sup>
ESC Y P2 P3 v1 . . . vn	Double Density / Double Speed Graphics Mode <sup>1)</sup>
ESC Z P2 P3 v1 . . . vn	Quadruple Density Graphics Mode <sup>1)</sup>

<sup>1)</sup> : for coding of P1, P2, P3 see **ESC \*** on the next page

**Table B-6: Graphics Modes**

Escape Sequence	Function
ESC * P1 P2 P3 v1 . . . vn	Select Various Graphics Modes P2 + P3 * 256 = number of columns (0/0...F/F) v1 .. vn = binary data in hex code (0/0...F/F)

*Parameter Table Graphic Density:*

P1	Graphic type	dots / column	max. number of columns	hor. density ( dpi )	
0/0	Standard Density (K)	8	816	60	
0/1	Double Density (L)	8	1632	120	
0/2	2xDensity / 2xSpeed (Y)	8	1632	120	*)
0/3	Quadruple Density (Z)	8	3264	240	*)
0/4	CRT I	8	1088	80	
0/6	CRT II	8	1224	90	
2/0	Standard Density	24	816	60	
2/1	Double Density	24	1632	120	
2/6	CRT III	24	1224	90	
2/7	Triple Density	24	2448	180	
2/8	Hex Density	24	4896	360	*)

\*) *consecutive horizontal dots cannot be printed.*

**Example:** box 8x8 dots with center point 2x2 dots, standard density, 8 dots / column  
hex: 1B 2A 00 08 00 FF 81 81 99 99 81 81 FF

**Table B-7: Character Set Selection**

Escape Sequence	Function
ESC 6	Enlarge Print Code Area (128-159 dec.)
ESC 7	Enable Upper Control Code (128-159 dec.)
ESC R P1	Select National Version P1 = 0/0 : U.S.A. P1 = 0/1 : FRANCE P1 = 0/2 : GERMANY P1 = 0/3 : U.K. P1 = 0/4 : DENMARK P1 = 0/5 : SWEDEN P1 = 0/6 : ITALY P1 = 0/7 : SPAIN P1 = 0/8 : JAPAN P1 = 0/9 : NORWAY P1 = 0/A : DENMARK 2 P1 = 0/B : SPAIN 2 P1 = 0/C : LATIN AM. P1 = 0/D : TURKEY P1 = 4/0 : LEGAL
ESC t P1	Select Character Table P1 = 0/0 : Italics Character Table P1 = 0/1 : Extended Graphics Character Table P1 = 0/2 : User Defined Character Table

**Table B-8: Further - Control Sequences, supported by  
EPSON LQ Emulation Mode (Native Commands)**

Escape Sequence	Mnemonic	Function
ESC [	\$\$	Control String Introducer (CSI) for ESC [
ESC	\$\$/	control String Introducer for ESC
ESC [ < s	EJF	Eject Form
ESC [ > s	IF	Insert Form
ESC [ P1 SP X	SPQ	Select Print Quality P1 = 0: LQ P1 = 1: NLQ
ESC [ P1 ; P2 SP r	SM #	Select Macro and Change Emulation P1 = 1: Macro 1 P1 = 2: Macro 2 P1 = 3: Macro 3 P1 = 4: Macro 4 P2 = 0: no change of emulation P2 = 1: EPSON Emulation P2 = 2: IBM ProPrinter Emulation P2 = 3: IBM ProPrinter AGM Emulation P2 = 4: EPSON Emulation

**Table B-8 (Cont.): Further - Control Sequences, supported by  
EPSON LQ Emulation Mode (Native Commands)**

Escape Sequence	Mnemonic	Function
ESC [ P1 ; P2 w	SNVCT	<p>Set National Version and Code Table            P1 = 1 - 15 national version            depending on selected character set (see            Appendix C Char. Set Tables)            P2 = 3 digit code of the code table (see            command SCT)</p> <p>P1 for national version <b>EPSON EXT. GCT:</b></p> <ul style="list-style-type: none"> <li>P1 = 1 : U.S.A</li> <li>P1 = 2 : France</li> <li>P1 = 3 : Germany</li> <li>P1 = 4 : U.K.</li> <li>P1 = 5 : Denmark</li> <li>P1 = 6 : Sweden</li> <li>P1 = 7 : Italy</li> <li>P1 = 8 : Spain</li> <li>P1 = 9 : Japan</li> <li>P1 = 1 0 : Norway</li> <li>P1 = 1 1 : Denmark 2</li> <li>P1 = 1 2 : Spain 2</li> <li>P1 = 1 3 : Latin AM</li> <li>P1 = 1 4 : Turkey</li> <li>P1 = 1 5 : Legal</li> </ul>
		<p>P1 for <b>IBM CODE PAGE:</b></p> <ul style="list-style-type: none"> <li>P1 = 1 : CP 437</li> <li>P1 = 2 : CP 850</li> <li>P1 = 3 : CP 860</li> <li>P1 = 4 : CP 863</li> <li>P1 = 5 : CP 865</li> <li>P1 = 6 : CP 858</li> </ul>
		<p>P1 for <b>CODE PAGE EE:</b></p> <ul style="list-style-type: none"> <li>P1 = 1 : CP 437 GK</li> <li>P1 = 2 : CP 851 GK</li> <li>P1 = 3 : CP 928 GK</li> <li>P1 = 4 : CP 855 CYRI</li> <li>P1 = 5 : CP 866</li> <li>P1 = 6 : CP 869</li> <li>P1 = 7 : CP 852</li> <li>P1 = 8 : KAMENICKY</li> <li>P1 = 9 : ISO LATIN 2</li> <li>P1 = 1 0 : MAZOVIA</li> <li>P1 = 1 1 : CP 437 HUN</li> <li>P1 = 1 2 : CP 852 SEE</li> <li>P1 = 1 3 : CP 866 LAT</li> <li>P1 = 1 4 : WIN LAT2</li> </ul>
ESC [ ; P2 w	SCT	<p>Set Code Table            P2 = 3 bit code of the code table            P2 = 0 6 1 : IBM Set 1            P2 = 0 6 2 : IBM Set 2            P2 = 0 6 3 : IBM Code Page            P2 = 0 7 1 : EPSON Ext. G. C. T            P2 = 1 0 0 : CODE PAGES EE            P2 = 1 0 1 : CODE PAGES EE2</p>

**Table B-8 (Cont.): Further - Control Sequences, supported by  
EPSON LQ Emulation Mode (Native Commands)**

Escape Sequence	Mnemonic	Function
ESC [ ; P2 ; P3 ; P4 ; P5 ; P6 ; P7 SP z <i>BARCODE Programming</i>	BH	Barcode Header P2: Barcode type P3: Height of barcode P4: Width of the thin bars P5: Width of the thin gaps P6: Ratio width to thin (bars / gaps) P7: Uni-directional or bi-directional printing 0 : or not programmed: means no changes 1 : uni-directional printing in LQ 2 : bi-directional printing in LQ 3 : uni-directional printing in NLQ 4 : bi-directional printing in NLQ
	<b>Note:</b>	A switch from uni-directional to bi-directional printing is only possible if the parameter <b>UNI-DIRECT.CMD</b> is set to <b>YES</b> via operator panel or ESC-sequence.
ESC [ ? 0 h	SMBC	Set Mode Barcode
ESC [ ? 0 l	RSBC	Reset Mode Barcode

**Table 9: ESC / P2 Commands**

Escape Sequence	Function
ESC ( c P1 P2 P3 P4 P5	<p><b>Set page format</b></p> <p>Sets top and bottom margins in the defined units.</p> <p>P1 = 04 00</p> <p>tm = P2 + P3 x 256 tm: top margin in units tm</p> <p>bm = P4 + P5 x 256 bm: bottom margin in units bm</p>
ESC ( C P1 P2 P3	<p><b>Set page length in defined unit</b></p> <p>Define page length in units</p> <p>P1 = 02 00</p> <p>pl = P2 + P3 x 256</p>
ESC ( V P1 P2 P3	<p><b>Set absolute vertical print position</b></p> <p>Define absolute vertical print position in units</p> <p>P1 = 02 00</p> <p>avpp = P2 + P3 x 256</p> <p>avpp: define print position from top margin in defined units</p>
ESC ( v P1 P2 P3	<p><b>Set relative vertical print position</b></p> <p>Define relative vertical print position in units</p> <p>P1 = 02 00</p> <p>rvpp = P2 + P3 x 256</p> <p>rvpp: moves the print position in defined units.</p>

**Table 9: (Cont.) ESC / P2 Commands**

Escape Sequence	Function
ESC X P1 P2 P3	<p><b>Select font by pitch and point</b></p> <p>P1 = 0 : No change in pitch  P1 = 1 : Selects proportional spacing  P1 = 18, 24, 30, 36, 42, 48, 60 or 72  Selects fixed pitch equal to 360/m  cpi  pz = P2 + P3 x 256  pz: Point size in 0,5 points; 1 point  equals 1/72 inch  pz = 0: No change in point size  pz = 16, 20, 21, 24, 28, 32, 36, 40, 42,  44, 48, 52, 56, 60, 64</p>
ESC ( U P1 P2	<p><b>Set unit</b></p> <p>P1 = 01 00  P2 = 10, 20, 30, 40, 50, 60 /3600"  P2 = 10; Standard</p>
ESC c P1 P2	<p><b>Set horizontal motion index (HMI)</b></p> <p>Define HMI-Index  Change pitch value in n/360"-steps  HMI = P1 + P2 x 256  HMI max. 3 inch</p>



**Table 9: (Cont.) ESC / P2 Commands**

Escape Sequence	Function
ESC ( t n1 n2 Pn P1 P2	<p><b>Assign character table</b></p> <p>n1 = 3, n2 = 0</p> <p>Pn = Parameter of ESC t : 0, 1, 2, 3, "0", "1", "2" or "3"</p> <p>P1 P2 = character table</p> <p>0 0 : italic</p> <p>1 0 : PC 437 (USA)</p> <p>3 0 : PC 850 (Multilingual)</p> <p>7 0 : PC 860 (Portugal)</p> <p>8 0 : PC 863 (French-Canada)</p> <p>9 0 : PC 865 (Norway)</p> <p>44 0 : PC 858 (Multilingual + Euro)</p> <p>The character table assigned by Pn is one of the four tables which will be selected by the ESC t command.</p>
ESC t Pn	<p><b>Select character table</b></p> <p>Selects the character table to be used for printing from among the four character tables which are assigned by ESC ( t command.</p> <p>Pn = 0/0 or 3/0 : Character Table 0</p> <p>Pn = 0/1 or 3/1 : Character Table 1</p> <p>Pn = 0/2 or 3/2 : Character Table 2</p> <p style="padding-left: 40px;">Re-maps downloaded Characters from the positions 0 to 127 to the positions 128 to 255.</p> <p>Pn = 0/3 or 3/3 : Character Table 3</p> <p><b>Default Setting</b></p> <p>Pn = 0/0 or 3/0 : Italics Character Table</p> <p>Pn = 0/1 or 3/1 : CP 437</p> <p>Pn = 0/2 or 3/2 : User Defined Character Table</p> <p>Pn = 0/3 or 3/3 : CP 437</p>

**Table 9: (Cont.) ESC / P2 Commands**

Escape Sequence	Function
ESC ( ^ P1 P2	<p><b>Print data as characters</b></p> <p>Prints n data bytes as characters, not control codes  <math>pd = P1 + P2 \times 256</math></p>
ESC ( G P1 P2	<p><b>Select graphics mode</b></p> <p>P1 = 01 00  P2 = 1 or 49</p> <p>Graphics mode may be reset by ESC @.</p>
ESC . P1 P2 P 3 P4 P5 P6	<p><b>Print raster graphics</b></p> <p>P1 = 0 : graphics mode non compressed  P1 = 1 : graphics mode compressed  P2 = 10, 20 : vertical resolution in 3600/v DPI  P3 = 10, 20 : horizontal resolution in 3600/h DPI  P4 : vertical dot count (rows of dot graphics) <math>1 &lt; P4 &lt; 24</math>  hzd : horizont dot count (columns of dot graphics)  <math>hzd = P5 + P6 \times 256</math>  Combination P2 = 10, P3 = 20 is not possible.</p>

Hex Code	Format	Page
00	Null	F-3
08	Backspace	F-3
09	Horizontal Tab	F-3
0A	Line Feed	F-3
0B	Vertical Tab	F-3
0C	Form Feed	F-3
0D	Carriage Return	F-3
11	Select Printer	F-3
12	Cancel Condensed Mode	F-3
13	Deselect Printer	F-3
14	Cancel Double Width	F-3
18	Cancel Buffer	F-3
1B	Escape	F-3
20	Space	F-3
7F	Delete	F-3
1B 0E or 0E	Select Double Width for One Line	F-3/7
1B 0F or 0F	Select Condensed Mode	F-3/7
1B 23	Cancel Most Significant Bit Control	F-3
1B 30	Set Line Space to $\frac{1}{8}$ "	F-4
1B 32	Set Line Space to $\frac{1}{6}$ "	F-4
1B 34	Set Italics	F-9
1B 35	Cancel Italics	F-9
1B 36	Enlarge Print Code Area	F-16
1B 37	Enable Upper Control Code Area	F-16
1B 3C	Select Unidirectional Mode (one line)	F-9
1B 3D	Set Most Significant Bit to 0	F-3
1B 3E	Set Most Significant Bit to 1	F-3
1B 40	Initialize Printer	F-3
1B 45	Select Emphasized (bold)	F-10
1B 46	Cancel Emphasized	F-10

Hex Code	Format	Page
1B 47	Select Double Strike (bold)	F-10
1B 48	Cancel Double Strike	F-10
1B 4D	Select Elite (12 cpi)	F-10
1B 4F	Cancel Automatic Perforation Skip	F-4
1B 50	Select Pica (10 cpi)	F-10
1B 54	Cancel Superscript/Subscript	F-10
1B 67	Select Pitch 15 cpi	F-11
24 24	Control String Introducer for ESC [	F-17
24 24 2F	Control String Introducer for ESC	F-17
1B 19 P <sub>1</sub>	Formfeed and ASF Control	F-5
1B 20 P <sub>1</sub>	Select Intercharacter Space	F-7
1B 21 P <sub>1</sub>	Select Multiple Print Mode	F-7
1B 25 00 / 1B 25 01	Select Standard- / User Defined Char. Set	F-7
1B 2B P <sub>1</sub>	Set line Space to $P^1/_{360}$ "	F-4
1B 2F P <sub>1</sub>	Select Variable Tab Channel	F-4
1B 2D 01 / 1B 2D 00	Select / Cancel Underline	F-9
1B 33 P <sub>1</sub>	Set Line Space to $P^1/_{180}$ "	F-4
1B 41 P <sub>1</sub>	Set line Space to $P^1/_{60}$ "	F-4
1B 42 00	Clear Vertical Tabs	F-4
1B 43 P <sub>1</sub>	Set Form Length in Lines	F-4
1B 44 00	Clear Horizontal Tabs	F-9
1B 4A P <sub>1</sub>	Perform $P^1/_{180}$ Line Feed	F-4
1B 4E P <sub>1</sub>	Set Automatic Perforation Skip	F-4
1B 51 P <sub>1</sub>	Set Right Margin	F-10
1B 52 P <sub>1</sub>	Set National Version	F-16
1B 53 00 / 1B 53 01	Select Superscript / Subscript	F-10
1B 55 00 / 1B 55 01	Cancel / Select Unidirectional Printing	F-10
1B 57 00 / 1B 57 01	Cancel / Select Double Width	F-10
1B 61 P <sub>1</sub>	Select Justification	F-10

Hex Code	Format	Page
1B 6A P <sub>1</sub>	Perform <sup>P<sub>1</sub></sup> / <sub>180</sub> Reverse Line Feed	F-4
1B 6B P <sub>1</sub>	Select Font	F-11
1B 6C P <sub>1</sub>	Set Left Margin	F-11
1B 70 00 / 1B 70 01	Cancel / Select Proportional	F-11
1B 71 P <sub>1</sub>	Select Character Style	F-11
1B 72 P <sub>1</sub>	Select Printing Colour	F-11
1B 74 P <sub>1</sub>	Select Character Table	F-16 F-22
1B 77 00 / 1B 77 01	Cancel / Select Double Height	F-12
1B 78 P <sub>1</sub>	Select Character Quality	F-12
1B 24 P <sub>1</sub> P <sub>2</sub>	Set Absolute Horizontal Position	F-7
1B 26 00 P <sub>1</sub> P <sub>2</sub> P <sub>3</sub> P <sub>4</sub> P <sub>5</sub> data	Define User Defined Characters	F-8
1B 28 2D P <sub>1</sub> P <sub>2</sub> P <sub>3</sub> P <sub>4</sub> P <sub>5</sub>	Select Line Marking	F-9
1B 28 43 P <sub>1</sub> P <sub>2</sub> P <sub>3</sub>	Set Page Length in defined Unit	F-20
1B 28 47 P <sub>1</sub> P <sub>2</sub>	Select Graphics Mode	F-23
1B 28 55 P <sub>1</sub> P <sub>2</sub>	Set Unit	F-21
1B 28 56 P <sub>1</sub> P <sub>2</sub> P <sub>3</sub>	Set absolute vertical Print Position	F-20
1B 28 63 P <sub>1</sub> P <sub>2</sub> P <sub>3</sub> P <sub>4</sub> P <sub>5</sub>	Set Page Format	F-20
1B 28 74 P <sub>1</sub> P <sub>2</sub> P <sub>3</sub> P <sub>4</sub>	Assign Character Table	F-22
1B 28 76 P <sub>1</sub> P <sub>2</sub> P <sub>3</sub>	Set relative vertical Print Position	F-20
1B 28 5E P <sub>1</sub> P <sub>2</sub>	Print Data as Character	F-23
1B 2A P <sub>1</sub> P <sub>2</sub> P <sub>3</sub> data	Select Various Graphics Modes	F-15
1B 2E P <sub>1</sub> P <sub>2</sub> P <sub>3</sub> P <sub>4</sub> P <sub>5</sub> P <sub>6</sub>	Print Raster Graphics	F-23
1B 3A 00 P <sub>1</sub> 00	Copy ROM Character Set to RAM	F-9
1B 3F 4B P <sub>1</sub>	Reassign Graphics Mode K	F-14
1B 3F 4C P <sub>1</sub>	Reassign Graphics Mode L	F-14
1B 3F 59 P <sub>1</sub>	Reassign Graphics Mode Y	F-14
1B 3F 5A P <sub>1</sub>	Reassign Graphics Mode Z	F-14
1B 42 P <sub>1</sub> ....P <sub>16</sub> 00	Set Vertical Tabs	F-4
1B 43 00 P <sub>1</sub>	Set Form Length in Inches	F-4

Hex Code	Format	Page
1B 44 P <sub>1</sub> P <sub>2</sub> ...P <sub>32</sub> 00	Set Horizontal Tabs	F-10
1B 4B P <sub>2</sub> P <sub>3</sub> data	Standard Density Graphics Mode	F-14
1B 4C P <sub>2</sub> P <sub>3</sub> data	Double Density Graphics Mode	F-14
1B 58 P <sub>1</sub> P <sub>2</sub> P <sub>3</sub>	Select Font by Pitch and Point	F-21
1B 59 P <sub>2</sub> P <sub>3</sub> data	Double Speed & Double Density Graph. Mode	F-14
1B 5A P <sub>2</sub> P <sub>3</sub> data	Quadruple Density Graphics Mode	F-14
1B 5B 3B P <sub>2</sub> 73	AGC / PCC Procedure	F-5
1B 5B 3B P <sub>2</sub> 77	Set Code Table	F-18
1B 5B 3B P <sub>2</sub> 3B P <sub>3</sub> 3B P <sub>4</sub> 3B P <sub>5</sub> 3B P <sub>6</sub> 3B P <sub>7</sub> 20 7A	Barcode Printing	F-19
1B 5B 3C 73	Eject Form	F-17
1B 5B 3E 73	Insert Form	F-17
1B 5B 3E P <sub>1</sub> 3B P <sub>2</sub> 3B P <sub>3</sub> 3B P <sub>4</sub> 73	Select Paper Source and Insert Form	F-5
1B 5B 3F 30 68	Set Mode Barcode	F-19
1B 5B 3F 30 6C	Reset Mode Barcode	F-19
1B 5B P <sub>1</sub> 20 58	Select Print Quality	F-17
1B 5B P <sub>1</sub> 3B P <sub>2</sub> 20 72	Select Makro and Change Emulation	F-17
1B 5B P <sub>1</sub> 3B P <sub>2</sub> 20 42	Graphic Size Modification	F-12
1B 5B P <sub>1</sub> 3B P <sub>2</sub> 77	Set National Version and Code Table	F-18
1B 5B P <sub>1</sub> 3B P <sub>2</sub> 78	Select Font and Character Pitch	F-13
1B 5B P <sub>1</sub> 77	Set National Version	F-18
1B 5C P <sub>1</sub> P <sub>2</sub>	Set Relative Horizontal Position	F-7
1B 62 P <sub>1</sub> 00	Clear Vertical Tabs in Channel P <sub>1</sub>	F-4
1B 62 m P <sub>1</sub> P <sub>2</sub> ...P <sub>9</sub> 00	Set Vertical Tab in Channel P <sub>1</sub>	F-4
1B 63 P <sub>1</sub> P <sub>2</sub>	Set Horizontal Motion Index (HMI)	F-21

## Hex - Decimal Conversion Table

	0	1	2	3	4	5	6	7	8	9	A	B	C	D	E	F
0	0	16	32	48	64	80	96	112	128	144	160	176	192	208	224	240
1	1	17	33	49	65	81	97	113	129	145	161	177	193	209	225	241
2	2	18	34	50	66	82	98	114	130	146	162	178	194	210	226	242
3	3	19	35	51	67	83	99	115	131	147	163	179	195	211	227	243
4	4	20	36	52	68	84	100	116	132	148	164	180	196	212	228	244
5	5	21	37	53	69	85	101	117	133	149	165	181	197	213	229	245
6	6	22	38	54	70	86	102	118	134	150	166	182	198	214	230	246
7	7	23	39	55	71	87	103	119	135	151	167	183	199	215	231	247
8	8	24	40	56	72	88	104	120	136	152	168	184	200	216	232	248
9	9	25	41	57	73	89	105	121	137	153	169	185	201	217	233	249
A	10	26	42	58	74	90	106	122	138	154	170	186	202	218	234	250
B	11	27	43	59	75	91	107	123	139	155	171	187	203	219	235	251
C	12	28	44	60	76	92	108	124	140	156	172	188	204	220	236	252
D	13	29	45	61	77	93	109	125	141	157	173	189	205	221	237	253
E	14	30	46	62	78	94	110	126	142	158	174	190	206	222	238	254
F	15	31	47	63	79	95	111	127	143	159	175	191	207	223	239	255

## Appendix F Barcode Quick Reference

### 1. Introduction

The barcode print facility is available in all three emulations.

### 2. Programming

There are three escape sequences to print barcodes

- The first sequence is to define the Barcode Header. The type of barcode as well as all parameters are selected by a header. The header does not affect any parameters outside the barcode application and remains valid until another header is transmitted or the printer is turned off. This can be done at any time but before barcode printing.

The header has the following format:

**ESC [ ; P<sub>2</sub> ; P<sub>3</sub> ; P<sub>4</sub> ; P<sub>5</sub> ; P<sub>6</sub> ; P<sub>7</sub> 8 z**      *Note: 8 = Space*

- In step two, the ESC-sequence "Set Mode Barcode (SMBC)" starts the barcode printing.

**ESC [ ? 0 h**

- Finally, the ESC-sequence "Reset Mode Barcode (RMBC)" will stop printing.

**ESC [ ? 0 l**

*Note:* Between **SMBC** and **RMBC** are only printable characters tolerated (no CR or LF).

#### 2.1 Barcode Header

Format	Function/Parameter	Hex Code
BH	Barcode Header P <sub>2</sub> = Barcode type; P <sub>3</sub> = Height of barcode; P <sub>4</sub> = Width of thin bars; P <sub>5</sub> = Width of thin gaps; P <sub>6</sub> = Ratio width to height; P <sub>7</sub> = Uni/Bidirectional printing	1B 5B 3B P <sub>2</sub> 3B P <sub>3</sub> 3B P <sub>4</sub> 3B P <sub>5</sub> 3B P <sub>6</sub> 3B P <sub>7</sub> 20 7A
SMBC	Start of Barcode	1B 5B 3F 30 68
RMBC	Stop Barcode	1B 5B 3F 30 6C



## Barcode Header Parameters

### P<sub>2</sub> Barcode type

- default = **101** (Code 39 horizontal)

Type	horizontal	horizontal + human readable text	vertical	vertical + human readable text
Code 39	101	201	301	401
2 of 5 industrial	102	202	302	402
2 or 5 interleaved	103	203	303	403
Codabar (Monarch)	104	204	304	404
EAN 8	105	205	not applicable	not applicable
EAN 13	106	206	not applicable	not applicable
Code 93	107	207	307	407
MSI Mod 10/10	108	208	308	408
UPC-E	109	209	not applicable	not applicable
UPC-A	110	210	not applicable	not applicable
Code 128 (EAN 128)	111	211	311	411
Postnet	112	not applicable	not applicable	not applicable
KIX Code	113	not applicable	not applicable	not applicable

### P<sub>3</sub> Height of barcode

- default:  $\frac{3}{12}$ " - 0.64 cm

All characters in a line are automatically repeated according to the selected barcode height. This is also true for plain text!

- $P_3 * \frac{1}{12}$ "
- possible values from:
  - 0 to 40 (30<sub>H</sub> to 34<sub>H</sub>30<sub>H</sub>) or (48<sub>D</sub> to 52<sub>D</sub>48<sub>D</sub>) for vertical barcodes
  - 0 to 99 (30<sub>H</sub> to 39<sub>H</sub>39<sub>H</sub>) or (48<sub>D</sub> to 57<sub>D</sub>57<sub>D</sub>) for horizontal barcodes

Barcode	Height in % of barcode length	minimum height in mm
Code 39	25	20 (0.8")
Codabar	25	20 (0.8")
Code 93	15	6.25 (0.25")
Code 128	15	6.25 (0.25")

**P<sub>4</sub> Width of the thin bars** (default:  $\frac{2}{144}'' = 0.35 \text{ mm}$ )

**Note:** The width of bars and gaps should be equal. For this, the parameters **P<sub>4</sub>** and **P<sub>5</sub>** should not deviate more than one step.

for horizontal Barcode

P <sub>4</sub>	hex	dec	inch	mm
0	30	48	2/144	0,35
1	31	49	3/144	0,53
2	32	50	4/144	0,70
3	33	51	5/144	0,88
4	34	52	6/144	1,05
5	35	53	7/144	1,23
6	36	54	8/144	1,41
7	37	55	9/144	1,58

for vertical Barcode

P <sub>4</sub>	hex	dec	inch	mm
0	30	48	2/180	0,28
1	31	49	3/180	0,42
2	32	50	4/180	0,56
3	33	51	5/180	0,70
4	34	52	6/180	0,85
5	35	53	7/180	0,99
6	36	54	8/180	1,12
7	37	55	9/180	1,27

**P<sub>5</sub> Width of the thin gaps** (default:  $\frac{2}{144}'' = 0.35 \text{ mm}$ )

The values are the same as in **P<sub>4</sub>**

**P<sub>6</sub> Ratio Width to Thin** (default: **0** (2 to 1))

<b>P<sub>6</sub></b>  value	Code 39 2 of 5 industrial 2 of 5 interleaved Codabar Code 93 MSI mod 10/10 Code 128	EAN 8 EAN 13 UPC-A UPC-E
	0	2.0 to 1
1	2.5 to 1	SC6
2	3.0 to 1	SC9
3	3.5 to 1	SC3

**Note:** Code 93, MSI 10/10, Code 128 are fixed 2.0 to 1  
Best results for Code 39, 2 of 5 industrial, 2 of 5 interleaved, and Codabar with 2.5 to 1

**P<sub>7</sub> Uni-directional or bi-directional printing** - standard 0 uni-directional

values are: 0 or not programmed means no changes  
1 uni-directional printing in LQ  
2 bi-directional printing in LQ  
3 uni-directional printing in NLQ  
4 bi-directional printing in NLQ

**Note:** A switch from uni-directional to bi-directional printing is only possible if the parameter **UNI-DIRECT.COMD** is set to **YES** via operator panel or ESC-sequence.

**Start Position of Barcode Printing**

The start position for barcode printing is the current print position.  
For both horizontal and vertical printing, the print position after printing barcodes is the same line as the start position next to the barcode printed.

## 2.2 Barcode Programming Examples

**Note:** All examples are coded in standard uni-directional printing - that means the parameter "P<sub>7</sub>" is not used.

In the following examples, 8 stands for "Space".

The small square  before and after the printed barcode indicates the actual print position.

Between **Start Barcode** and **Stop Barcode** are only printable characters tolerated (no CR or LF).

### Barcode Example for Code 39

```
Barcode Header:   ESC [ ; P2 ; P3 ; P4 ; P5 ; P6 ; P7 8 z
                  ESC [ ; 201 ; 8 ; 1 ; 1 ; 1 ; 8 z
Start Barcode:   ESC [ ? 0 h
Data:           * C 8 O 8 D 8 E 8 8 8 3 9 *
Stop Barcode:   ESC [ ? 0 /
```



### Barcode Example for 2 of 5 Industrial

```
Barcode Header:   ESC [ ; P2 ; P3 ; P4 ; P5 ; P6 ; P7 8 z
                  ESC [ ; 202 ; 8 ; 1 ; 1 ; 1 ; 8 z
Start Barcode:   ESC [ ? 0 h
Data:           : 1 2 3 4 5 6 7 8 9 0 ;
Stop Barcode:   ESC [ ? 0 /
```

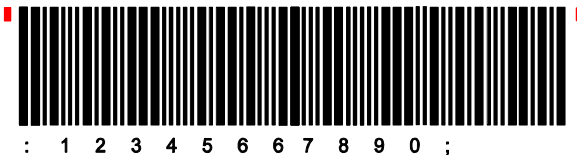

### Barcode Example for 2 of 5 Interleaved

Barcode Header:      ESC [ ; P<sub>2</sub> ; P<sub>3</sub> ; P<sub>4</sub> ; P<sub>5</sub> ; P<sub>6</sub> ; P<sub>7</sub> 8 z  
                          ESC [ ; 203 ; 8 ; 1 ; 1 ; 1 ; 8 z  
Start Barcode:        ESC [ ? 0 h  
Data:                    : 1 2 3 4 5 6 7 8 9 0 ;  
Stop Barcode:         ESC [ ? 0 /

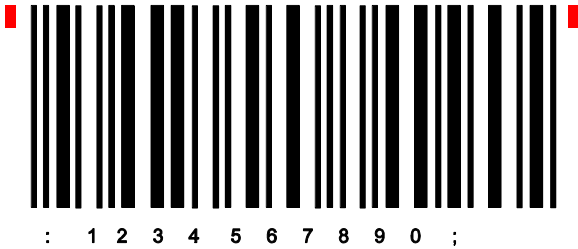

### Barcode Example for Codabar (Monarch)

Barcode Header:      ESC [ ; P<sub>2</sub> ; P<sub>3</sub> ; P<sub>4</sub> ; P<sub>5</sub> ; P<sub>6</sub> ; P<sub>7</sub> 8 z  
                          ESC [ ; 204 ; 8 ; 1 ; 1 ; 1 ; 8 z  
Start Barcode:        ESC [ ? 0 h  
Data:                    a 0 1 2 3 4 5 6 7 8 9 t  
Stop Barcode:         ESC [ ? 0 /



### Barcode Example for EAN 8

Barcode Header:      ESC [ ; P<sub>2</sub> ; P<sub>3</sub> ; P<sub>4</sub> ; P<sub>5</sub> ; P<sub>6</sub> ; P<sub>7</sub> 8 z  
                               ESC [ ; 205 ; 8 ;        ;        ; 1 ; 8 z  
 Start Barcode:        ESC [ ? 0 h  
 Data:                    4 0 1 2 3 4 5 5  
 Stop Barcode:         ESC [ ? 0 /



### Barcode Example for EAN 8 ADD-2

Barcode Header:      ESC [ ; P<sub>2</sub> ; P<sub>3</sub> ; P<sub>4</sub> ; P<sub>5</sub> ; P<sub>6</sub> ; P<sub>7</sub> 8 z  
                               ESC [ ; 205 ; 8 ;        ;        ; 1 ; 8 z  
 Start Barcode:        ESC [ ? 0 h  
 Data:                    4 0 1 2 3 4 5 5 1 2  
 Stop Barcode:         ESC [ ? 0 /



### Barcode Example for EAN 8 ADD-5

Barcode Header:     ESC [ ; P<sub>2</sub> ; P<sub>3</sub> ; P<sub>4</sub> ; P<sub>5</sub> ; P<sub>6</sub> ; P<sub>7</sub> 8 z  
                      ESC [ ; 205 ; 8 ;     ;     ; 1 ; 8 z  
Start Barcode:     ESC [ ? 0 h  
Data:                4 0 1 2 3 4 5 5 8 6 1 0 4  
Stop Barcode:     ESC [ ? 0 /



### Barcode Example for EAN 13

Barcode Header:     ESC [ ; P<sub>2</sub> ; P<sub>3</sub> ; P<sub>4</sub> ; P<sub>5</sub> ; P<sub>6</sub> ; P<sub>7</sub> 8 z  
                      ESC [ ; 206 ; 8 ;     ;     ; 1 ; 8 z  
Start Barcode:     ESC [ ? 0 h  
Data:                4 1 2 3 4 5 6 7 8 9 0 1 8  
Stop Barcode:     ESC [ ? 0 /

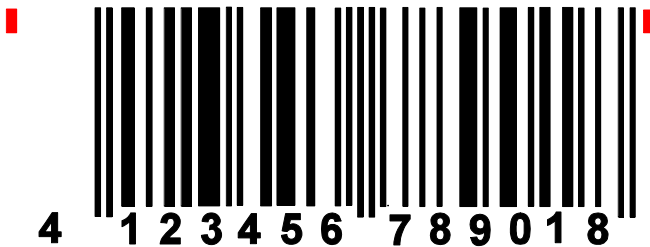

**Barcode Example for EAN 13 ADD-2**

Barcode Header:      ESC [ ; P<sub>2</sub> ; P<sub>3</sub> ; P<sub>4</sub> ; P<sub>5</sub> ; P<sub>6</sub> ; P<sub>7</sub> 8 z  
                           ESC [ ; 206 ; 8 ;     ;     ; 1 ; 8 z  
 Start Barcode:      ESC [ ? 0 h  
 Data:                 4 1 2 3 4 5 6 7 8 9 0 1 8 1 2  
 Stop Barcode:      ESC [ ? 0 /



**Barcode Example for EAN 13 ADD-5**

Barcode Header:      ESC [ ; P<sub>2</sub> ; P<sub>3</sub> ; P<sub>4</sub> ; P<sub>5</sub> ; P<sub>6</sub> ; P<sub>7</sub> 8 z  
                           ESC [ ; 206 ; 8 ;     ;     ; 1 ; 8 z  
 Start Barcode:      ESC [ ? 0 h  
 Data:                 4 1 2 3 4 5 6 7 8 9 0 1 8 8 6 1 0 4  
 Stop Barcode:      ESC [ ? 0 /





### Barcode Example for Code 93

Barcode Header:      ESC [ ; P<sub>2</sub> ; P<sub>3</sub> ; P<sub>4</sub> ; P<sub>5</sub> ; P<sub>6</sub> ; P<sub>7</sub> 8 z  
                          ESC [ ; 207 ; 8 ; 1 ; 1 ;        ; 8 z  
Start Barcode:        ESC [ ? 0 h  
Data:                    a C + O + D + E 8 9 3 W I e  
Stop Barcode:         ESC [ ? 0 /



### Barcode Example for MSI Mod 10/10

Barcode Header:      ESC [ ; P<sub>2</sub> ; P<sub>3</sub> ; P<sub>4</sub> ; P<sub>5</sub> ; P<sub>6</sub> ; P<sub>7</sub> 8 z  
                          ESC [ ; 208 ; 8 ; 1 ; 1 ;        ; 8 z  
Start Barcode:        ESC [ ? 0 h  
Data:                    : 1 2 3 4 5 6 7 4 1 ;  
Stop Barcode:         ESC [ ? 0 /

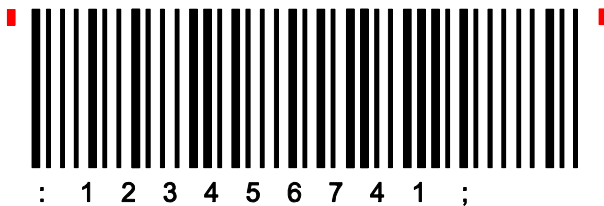

### Barcode Example for UPC-E

Barcode Header:      ESC [ ; P<sub>2</sub> ; P<sub>3</sub> ; P<sub>4</sub> ; P<sub>5</sub> ; P<sub>6</sub> ; P<sub>7</sub> 8 z  
                           ESC [ ; 209 ; 8 ;     ;     ; 1 ; 8 z  
 Start Barcode:      ESC [ ? 0 h  
 Data:                 0 1 2 3 4 5 6 5  
 Stop Barcode:      ESC [ ? 0 /

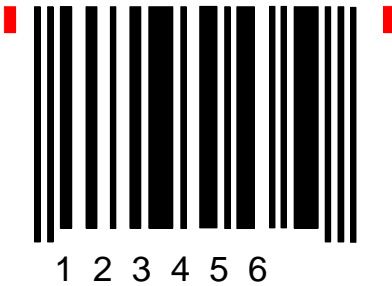

### Barcode Example for UPC-E ADD-2

Barcode Header:      ESC [ ; P<sub>2</sub> ; P<sub>3</sub> ; P<sub>4</sub> ; P<sub>5</sub> ; P<sub>6</sub> ; P<sub>7</sub> 8 z  
                           ESC [ ; 209 ; 8 ;     ;     ; 1 ; 8 z  
 Start Barcode:      ESC [ ? 0 h  
 Data:                 0 1 2 3 4 5 6 5 1 2  
 Stop Barcode:      ESC [ ? 0 /



### Barcode Example for UPC-E ADD-5

Barcode Header:      ESC [ ; P<sub>2</sub> ; P<sub>3</sub> ; P<sub>4</sub> ; P<sub>5</sub> ; P<sub>6</sub> ; P<sub>7</sub> 8 z  
                          ESC [ ; 209 ; 8 ;        ;        ; 1 ; 8 z  
Start Barcode:        ESC [ ? 0 h  
Data:                    0 1 2 3 4 5 6 5 8 6 1 0 4  
Stop Barcode:         ESC [ ? 0 /

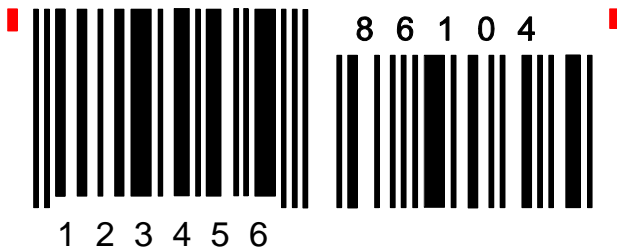

### Barcode Example for UPC-A

Barcode Header:      ESC [ ; P<sub>2</sub> ; P<sub>3</sub> ; P<sub>4</sub> ; P<sub>5</sub> ; P<sub>6</sub> ; P<sub>7</sub> 8 z  
                          ESC [ ; 210 ; 8 ;        ;        ; 1 ; 8 z  
Start Barcode:        ESC [ ? 0 h  
Data:                    0 1 2 3 4 5 6 7 8 9 0 5  
Stop Barcode:         ESC [ ? 0 /

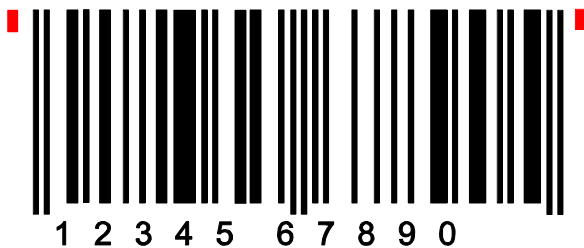

**Barcode Example for UPC-A ADD-2**

Barcode Header:      ESC [ ; P<sub>2</sub> ; P<sub>3</sub> ; P<sub>4</sub> ; P<sub>5</sub> ; P<sub>6</sub> ; P<sub>7</sub> 8 z  
                             ESC [ ; 210 ; 8 ;     ;     ; 1 ; 8 z  
 Start Barcode:      ESC [ ? 0 h  
 Data:                    0 1 2 3 4 5 6 7 8 9 0 5 1 2  
 Stop Barcode:        ESC [ ? 0 /



**Barcode Example for UPC-A ADD-5**

Barcode Header:      ESC [ ; P<sub>2</sub> ; P<sub>3</sub> ; P<sub>4</sub> ; P<sub>5</sub> ; P<sub>6</sub> ; P<sub>7</sub> 8 z  
                             ESC [ ; 210 ; 8 ;     ;     ; 1 ; 8 z  
 Start Barcode:      ESC [ ? 0 h  
 Data:                    0 1 2 3 4 5 6 7 8 9 0 5 8 6 1 0 4  
 Stop Barcode:        ESC [ ? 0 /



### Barcode Example for Code 128

Barcode Header:      ESC [ ; P<sub>2</sub> ; P<sub>3</sub> ; P<sub>4</sub> ; P<sub>5</sub> ; P<sub>6</sub> ; P<sub>7</sub> 8 z  
                          ESC [ ; 211 ; 8 ; 1 ; 1 ;        ; 8 z  
Start Barcode:        ESC [ ? 0 h  
Data:                    C o d e 8 1 2 8  
Stop Barcode:        ESC [ ? 0 /

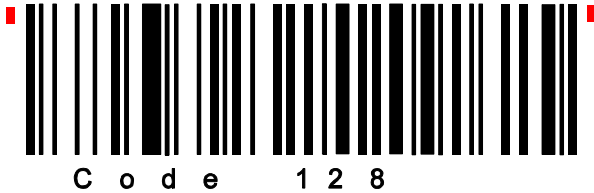

### Barcode Example for Code 128 using FNC1 = Coding ] c 1

Barcode Header:      ESC [ ; P<sub>2</sub> ; P<sub>3</sub> ; P<sub>4</sub> ; P<sub>5</sub> ; P<sub>6</sub> ; P<sub>7</sub> 8 z  
                          ESC [ ; 211 ; 8 ; 1 ; 1 ;        ; 8 z  
Start Barcode:        ESC [ ? 0 h  
Data:                    ] C 1 0 0 3 4 0 1 2 3 4 5 1 2 3 4 5 6 7 8 9 5  
Stop Barcode:        ESC [ ? 0 /

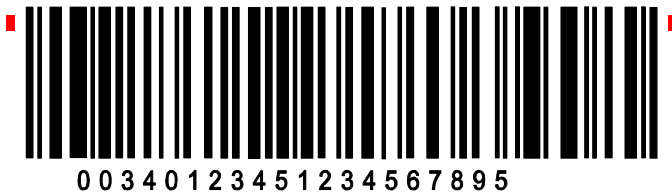

**Barcode Example for POSTNET**

Barcode Header:      **ESC [ ; P<sub>2</sub> ; P<sub>3</sub> ; P<sub>4</sub> ; P<sub>5</sub> ; P<sub>6</sub> ; P<sub>7</sub> 8 z**  
                           **ESC [ ; 112 ;    ;    ;    ;    ; 8 z**

Start Barcode:        **ESC [ ? 0 h**

Data:                    **1 2 3 4 5 6 7 8 9 0 1**

Stop Barcode:        **ESC [ ? 0 /**

Data:                    **CR LF LF**  
                           Mark Pollan CR LF  
                           101 Main St CR LF  
                           Anytown US 12345-6789



Mark Pollan  
 101 main St  
 Anytown US 12345-6789

**Barcode Example for KIX - PTT, Post Nederland**

Barcode Header:      **ESC [ ; P<sub>2</sub> ; P<sub>3</sub> ; P<sub>4</sub> ; P<sub>5</sub> ; P<sub>6</sub> ; P<sub>7</sub> 8 z**  
                           **ESC [ ; 113 ;    ;    ;    ;    ; 8 z**

Start Barcode:        **ESC [ ? 0 h**

Data:                    **1 2 3 4 5 6 7 8 9 0**

Stop Barcode:        **ESC [ ? 0 /**



### Programming two Barcodes symbols on the same line

Barcode Header:        **ESC [ ; P<sub>2</sub> ; P<sub>3</sub> ; P<sub>4</sub> ; P<sub>5</sub> ; P<sub>6</sub> ; P<sub>7</sub> 8 z**  
                              **ESC [ ; 201 ; 7 ; 0 ; 0 ; 1 ; 8 z**

Start Barcode:        **ESC [ ? 0 h**

Data:                    **\* C 8 0 8 D 8 E 8 8 8 3 9 \***

Stop Barcode:        **ESC [ ? 0 /**

Blank zone            8 8 8

Start Barcode:        **ESC [ ? 0 h**

Data:                    **\* C 8 0 8 D 8 E 8 8 8 3 9 \***

Stop Barcode:        **ESC [ ? 0 /**



**Programming two Barcodes symbols separated by CR and LF**

Barcode Header:      **ESC [ ; P<sub>2</sub> ; P<sub>3</sub> ; P<sub>4</sub> ; P<sub>5</sub> ; P<sub>6</sub> ; P<sub>7</sub> 8 z**  
                              **ESC [ ; 201 ; 7 ; 0 ; 0 ; 1 ; 8 z**

Start Barcode:        **ESC [ ? 0 h**

Data:                    **\* C 8 0 8 D 8 E 8 8 8 3 9 \***

Stop Barcode:         **ESC [ ? 0 /**

Blank zone:            **CR LF LF LF LF LF LF LF LF**

Start Barcode:        **ESC [ ? 0 h**

Data:                    **\* C 8 0 8 D 8 E 8 8 8 3 9 \***

Stop Barcode:         **ESC [ ? 0 /**





### Programming two Barcodes symbols in landscape on the same line

Barcode Header:        **ESC [ ; P<sub>2</sub> ; P<sub>3</sub> ; P<sub>4</sub> ; P<sub>5</sub> ; P<sub>6</sub> ; P<sub>7</sub> 8 z**  
                              **ESC [ ; 401 ; 7 ; 0 ; 0 ; 1 ; 8 z**

Start Barcode:         **ESC [ ? 0 h**

Data:                    **\* C 8 0 8 D 8 E 8 8 8 3 9 \***

Stop Barcode:         **ESC [ ? 0 /**

Blank zone:            8 8 8

Start Barcode:         **ESC [ ? 0 h**

Data:                    **\* C 8 0 8 D 8 E 8 8 8 3 9 \***

Stop Barcode:         **ESC [ ? 0 /**

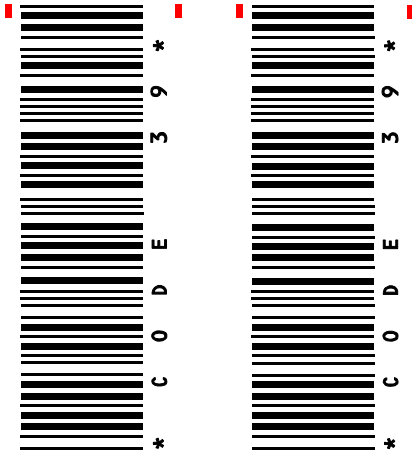



## Appendix G Information for the System Manager

### Reset off Menu Access

To reactivate the menu access function, perform the following steps:

- S Switch off the printer. Press the **MENU** and **START/STOP** keys simultaneously. While holding down the two keys, switch on the printer. When the message **MENU ACCESS** is displayed, release the keys. Now you are able to change the menu access function. If the new setting is supposed to be permanent, don't forget the **SAVE** function.

### Printer drivers

The printer drivers for Windows 3.x, 95, 98, NT 4.0 are available. (see **CD-ROM**).