

WorkForce[®] 845 User's Guide

Contents

WorkForce 845 User's Guide	13
Product Basics	14
Setting Up the Control Panel	14
Touch Panel Buttons and Lights	14
Adjusting Control Panel Position	15
Changing LCD Screen Language.....	16
Turning Off Control Panel Sounds.....	16
Product Parts Locations	17
Product Parts - Top.....	17
Product Parts - Front	19
Product Parts - Inside	20
Product Parts - Back.....	21
Two-Sided Printing, Scanning, Copying, and Faxing	21
Selecting Wireless Network Settings From the Touch Panel	22
Loading Paper	25
Loading Plain Paper in the Cassette	25
Loading Photo Paper in Cassette 1	30
Loading Envelopes	36
Paper Loading Capacity	39
Available EPSON Papers.....	40
Paper or Media Type Settings.....	41
Borderless Paper Type Compatibility	42
Placing Originals on the Product	43
Placing Originals on the Scanner Glass	43
Placing Originals in the Automatic Document Feeder	44
Copying	48
Copying Documents or Photos.....	48
Paper Type Settings - Copying.....	49
Paper Size Settings - Copying.....	50
Copying Options.....	51

Printing From a Computer	53
Printing with Windows	53
Selecting Basic Print Settings - Windows	53
Paper Source Options - Windows	55
Print Quality Options - Windows	56
Multi-Page Printing Options - Windows.....	56
Selecting Double-sided Printing Settings - Windows	57
Double-sided Printing Options - Windows.....	59
Print Density Adjustments - Windows	60
Selecting Additional Layout and Print Options - Windows	60
Custom Color Correction Options - Windows.....	61
Additional Settings Options - Windows	63
Selecting a Printing Preset - Windows.....	63
Printing Your Document or Photo - Windows	64
Selecting Default Print Settings - Windows.....	65
Changing the Language of the Printer Software Screens	66
Changing Automatic Update Options	67
Printing with Mac OS X 10.5, 10.6, or 10.7.....	68
Selecting Basic Print Settings - Mac OS X 10.5/10.6/10.7	69
Paper Source Options - Mac OS X 10.5/10.6/10.7.....	72
Print Quality Options - Mac OS X 10.5/10.6/10.7	72
Print Options - Mac OS X 10.5/10.6/10.7	73
Selecting Page Setup Settings - Mac OS X 10.5/10.6/10.7	73
Selecting Print Layout Options - Mac OS X 10.5/10.6/10.7	74
Selecting Double-sided Printing Settings - Mac OS X 10.5/10.6/10.7	75
Double-sided Printing Options and Adjustments - Mac OS X	76
Managing Color - Mac OS X 10.5/10.6/10.7	77
Color Matching and Color Options - Mac OS X 10.5/10.6/10.7	78
Selecting Printing Preferences - Mac OS X 10.5/10.6/10.7	79
Printing Preferences - Mac OS X 10.5/10.6/10.7	80
Printing Your Document or Photo - Mac OS X 10.5/10.6/10.7	80
Checking Print Status - Mac OS X 10.5/10.6/10.7	81
Printing with Mac OS X 10.4.....	82

Selecting Page Setup Settings - Mac OS X 10.4	83
Selecting Basic Print Settings - Mac OS X 10.4.....	84
Paper Source Options - Mac OS X 10.4.....	86
Print Quality Options - Mac OS X 10.4.....	86
Print Options - Mac OS X 10.4.....	86
Selecting Print Layout Options - Mac OS X 10.4	87
Selecting Double-sided Printing Settings - Mac OS X 10.4	88
Managing Color - Mac OS X 10.4.....	89
Color Options - Mac OS X 10.4.....	90
Selecting Printing Preferences - Mac OS X 10.4	90
Printing Preferences - Mac OS X 10.4.....	91
Printing Your Document or Photo - Mac OS X 10.4.....	91
Checking Print Status - Mac OS X 10.4	92
Cancelling Printing Using a Product Button.....	93
Scanning	94
Starting a Scan.....	94
Starting a Scan Using the Product Control Panel	94
Scan to Memory Card Options.....	96
Changing Default Scan Button Settings.....	96
Starting a Scan Using the EPSON Scan Icon.....	97
Starting a Scan from a Scanning Program	99
Selecting EPSON Scan Settings.....	101
Scan Modes	101
Selecting the Scan Mode.....	101
Scanning in Home Mode	102
Selecting a Scan Area - Home Mode	105
Available Image Adjustments - Home Mode	108
Selecting a Scan Size - Home Mode.....	109
Scanning in Office Mode.....	111
Selecting a Scan Area - Office Mode	113
Available Image Adjustments - Office Mode	115
Scanning in Professional Mode	116
Available Image Types - Professional Mode.....	119

Selecting a Scan Area - Professional Mode	119
Available Image Adjustments - Professional Mode	122
Selecting a Scan Size - Professional Mode	124
Image Preview Guidelines	127
Scan Resolution Guidelines	127
Selecting Scan File Settings	128
Available Scanned File Types and Optional Settings	129
Scanning with Mac OS X 10.6/10.7 Using Image Capture	130
Scanning Special Projects	132
Scanning to a PDF File	132
Restoring Photo Colors as You Scan	135
Convert Scanned Documents to Editable Text (OCR)	136
Scanning Using OCR - Windows	136
Scanning Using OCR - Mac OS X	138
Faxing	141
Connecting a Telephone or Answering Machine	141
Setting Up Fax Features	144
Setting Up Fax Features Using the Product Control Panel	145
Selecting Your Country or Region	145
Selecting the Date and Time	147
Entering Fax Header Information	149
Entering Numbers and Characters for Faxing	150
Selecting Fax Send and Receive Settings	151
Selecting Fax Communication Settings	153
Printing Fax Reports	154
Restoring Default Fax Settings	155
Fax Scan & Print Options	157
Fax Communications Options	157
Fax Report Options	158
Restore Default Settings Options	159
Setting Up Fax Features Using the Fax Utility - Windows	159
Setting Up Fax Features Using the Fax Utility - Mac OS X	161
Setting Up Speed Dial and Group Dial Lists	162

Setting Up Speed/Group Dial Lists Using the Product Control Panel	163
Creating Speed Dial List Entries	163
Printing Your Speed Dial List	165
Creating Group Dial List Entries.....	167
Printing Your Group Dial List.....	170
Setting Up Speed/Group Dial Lists Using the Fax Utility - Windows.....	172
Setting Up Speed/Group Dial Lists Using the Fax Utility - Mac OS X	175
Sending Faxes	176
Sending Faxes from the Product Control Panel.....	177
Manually Dialing or Redialing Fax Numbers	177
Selecting Fax Numbers from Speed or Group Dial Lists.....	178
Dialing Fax Numbers from a Connected Telephone	179
Fax Send Options	181
Sending Faxes Using the Fax Utility - Windows	182
Sending Faxes Using the Fax Utility - Mac OS X.....	184
Receiving Faxes.....	186
Fax Reception	186
Receiving Faxes Automatically (Auto Answer)	187
Receiving Faxes Manually.....	187
Using Memory Cards With Your Product	189
Inserting a Memory Card.....	189
Memory Card Types	190
Memory Card File Specifications.....	191
Removing a Memory Card.....	191
Printing from a Memory Card	192
Viewing and Printing Photos.....	192
Viewing and Printing Individual Photos	193
Printing All Photos.....	195
Printing Photos by Date	197
Viewing and Printing Photos from a Slide Show	200
Cropping Photos Displayed on the LCD Screen	201
Modifying Photos Displayed on the LCD Screen	202
Photo Adjustment Options	202

Selecting Print Settings for Photos Displayed on the LCD Screen.....	204
Print Setting Options - Photo Mode.....	204
Printing Photo Layouts from a Memory Card.....	205
Photo Layout Options	207
Printing Photo Greeting Cards.....	208
Creating and Printing a Greeting Card Template	208
Printing a Greeting Card from a Template	210
Printing Photo Proofsheets from a Memory Card	211
Transferring Photos on a Memory Card	212
Transferring Photos from a Memory Card to Your Computer	212
Setting Up File Sharing for Photo Transfers From Your Computer	213
Transferring Photos from a Memory Card to an External Device	214
Using an External Device with Your Product	216
Wireless Printing from a Mobile Device.....	216
Printing from a Camera Connected to Your Product	216
Connecting and Printing From a Camera	216
Selecting Print Settings for Printing From a Camera	218
Print Settings - Camera.....	220
Photo Adjustments - Camera.....	220
Viewing or Printing from a USB Flash Drive or External Device	222
USB Device File Specifications	222
Connecting and Using a USB Flash Drive or External Device	222
Charging a USB Device Using Your Product.....	223
Printing Personalized Projects.....	225
Printing Personalized Note Paper	225
Printing Lined Paper and Graph Paper	226
Replacing Ink Cartridges	228
Check Cartridge Status	228
Checking Cartridge Status on the LCD Screen	228
Checking Cartridge Status with Windows.....	229
Checking Cartridge Status with Mac OS X	232
Purchase EPSON Ink Cartridges	233
Ink Cartridge Part Numbers.....	233

Removing and Installing Ink Cartridges.....	234
Printing With Black Ink and Expended Color Cartridges	239
Printing With Expended Color Cartridges - Windows	239
Printing With Expended Color Cartridges - Mac OS X 10.5/10.6/10.7	239
Conserving Low Black Ink with Windows	240
Adjusting Print Quality.....	242
Print Head Maintenance.....	242
Print Head Nozzle Check.....	242
Checking the Nozzles Using the Product Control Panel	242
Checking the Nozzles Using a Computer Utility.....	245
Print Head Cleaning	247
Cleaning the Print Head Using the Product Control Panel	247
Cleaning the Print Head Using a Computer Utility.....	249
Print Head Alignment.....	252
Aligning the Print Head Using the Product Control Panel	252
Aligning the Print Head Using a Computer Utility	254
Cleaning the Paper Path	257
Cleaning and Transporting Your Product	258
Cleaning Your Product	258
Transporting Your Product	259
Solving Problems	261
Checking for Software Updates.....	261
Product Status Messages	262
Running a Product Check	263
Resetting Control Panel Defaults	265
Solving Setup Problems	266
Noise After Ink Installation	266
Software Installation Problems	266
Control Panel Setup Problems	267
Solving Network Problems	267
Product Cannot Connect to a Wireless Router or Access Point	268
Network Software Cannot Find Product on a Network.....	268
Product Does Not Appear in Mac OS X Printer Window	269

Cannot Print Over a Network.....	269
Cannot Scan Over a Network.....	270
Printing a Network Status Sheet.....	270
Solving Copying Problems.....	271
Product Makes Noise, But Nothing Copies.....	271
Product Makes Noise When It Sits for a While.....	272
Solving Paper Problems.....	272
Paper Feeding Problems.....	272
Paper Jam Problems Inside the Product.....	273
Paper Jam Problems in a Cassette.....	274
Paper Jam Problems in the Duplexer.....	276
Document Jams in the Automatic Document Feeder.....	279
Paper Ejection Problems.....	283
Solving Problems Printing from a Computer.....	283
Nothing Prints.....	284
Product Icon Does Not Appear in Windows Taskbar.....	284
Error After Cartridge Replacement.....	285
Printing is Slow.....	285
Solving Page Layout and Content Problems.....	286
Inverted Image.....	287
Too Many Copies Print.....	287
Blank Pages Print.....	287
Incorrect Margins on Printout.....	288
Incorrect Characters Print.....	289
Incorrect Image Size or Position.....	289
Slanted Printout.....	290
Solving Print Quality Problems.....	290
White or Dark Lines in Printout.....	290
Blurry or Smearred Printout.....	291
Faint Printout or Printout Has Gaps.....	292
Grainy Printout.....	293
Incorrect Colors.....	294
Solving Scanning Problems.....	294

Scanning Software Does Not Operate Correctly	295
Cannot Start EPSON Scan.....	295
Solving Scanned Image Quality Problems	296
Image Consists of a Few Dots Only.....	296
Line of Dots Appears in All Scanned Images.....	297
Straight Lines in an Image Appear Crooked.....	297
Image is Distorted or Blurry	297
Image Colors are Patchy at the Edges	298
Image is Too Dark	298
Back of Original Image Appears in Scanned Image	298
Ripple Patterns Appear in an Image.....	298
Scanned Image Colors Do Not Match Original Colors.....	299
Scan Area is Not Adjustable in Thumbnail Preview	299
Scanned Image Edges are Cropped	299
Solving Faxing Problems.....	300
Cannot Send or Receive Faxes.....	300
Cannot Receive Faxes with a Telephone Connected to Your Product	301
When to Uninstall Your Product Software	301
Uninstalling Product Software - Windows.....	301
Uninstalling Product Software - Mac OS X	302
Where to Get Help.....	303
Technical Specifications	304
Windows System Requirements	304
Mac System Requirements	305
Printing Specifications.....	305
Scanning Specifications	305
Automatic Document Feeder (ADF) Specifications.....	306
Fax Specifications	306
Paper Specifications	307
Printable Area Specifications	308
Ink Cartridge Specifications.....	309
Dimension Specifications	310
Electrical Specifications	310

Environmental Specifications	311
Interface Specifications	311
External USB Device Specifications.....	311
Network Interface Specifications	312
Safety and Approvals Specifications	312
Notices	314
FCC Compliance Statement.....	314
Software Notices	316
Trademarks	320
Copyright Notice.....	320
libTIFF Software Acknowledgment.....	321
A Note Concerning Responsible Use of Copyrighted Materials.....	321
Default Delay Times for Power Management for EPSON Products	322
Copyright Attribution	322

WorkForce 845 User's Guide

Welcome to the WorkForce 845 *User's Guide*.

Product Basics

See these sections to learn about the basic features of your product.

[Setting Up the Control Panel](#)

[Product Parts Locations](#)

[Two-Sided Printing, Scanning, Copying, and Faxing](#)

[Selecting Wireless Network Settings From the Touch Panel](#)

Setting Up the Control Panel

See these sections to set up the control panel for use.

[Touch Panel Buttons and Lights](#)

[Adjusting Control Panel Position](#)



[Changing LCD Screen Language](#)



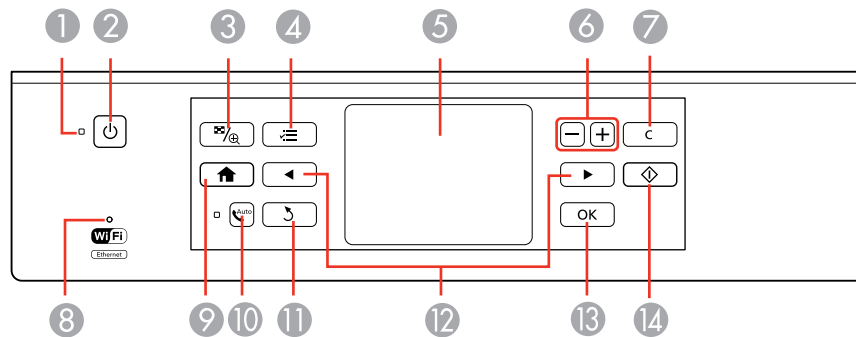

[Turning Off Control Panel Sounds](#)

Parent topic: [Product Basics](#)

Touch Panel Buttons and Lights



- 1 The power light
- 2 The  on button
- 3 The  display/crop button

- 4 The  menu button
- 5 The LCD screen
- 6 The + and – buttons (increase or decrease the number of copies)
- 7 The **C** clear button
- 8 The WiFi light
- 9 The  home button
- 10 The  auto answer light
- 11 The  back button
- 12 The arrow buttons
- 13 The **OK** button
- 14 The  start button

Parent topic: [Setting Up the Control Panel](#)

Adjusting Control Panel Position

You can adjust the position of the control panel to make it easier to access. Squeeze the release bar and raise or lower the control panel.

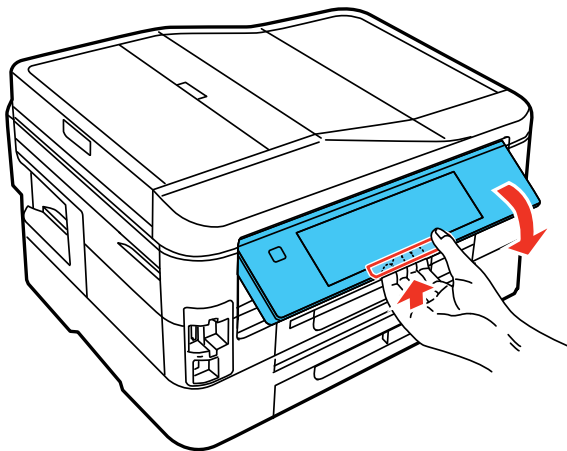



Caution: Do not lower the control panel without first squeezing the release bar or you may damage your product.

Parent topic: [Setting Up the Control Panel](#)

Changing LCD Screen Language



You can change the language used on the LCD screen.

1. Press the  home button, if necessary.
2. Select **Setup**.
3. Select **Printer Setup**.
4. Press the arrow buttons and then select **Language**.
5. Select a language.
6. Press the  home button to exit.

Parent topic: [Setting Up the Control Panel](#)

Turning Off Control Panel Sounds

You can turn off the sound heard when you press buttons on the control panel.

1. Press the  home button, if necessary.
2. Select **Setup**.
3. Select **Printer Setup**.
4. Select **Sound**.
5. Select one of these **Sound** options; then select **Off** to turn off the sound:
 - **Button Press**
 - **Error Notice**
 - **Completion Notice**
6. To adjust the sound volume, select **Volume**, then select **High** or **Low**
7. Press the  home button to exit.

Parent topic: [Setting Up the Control Panel](#)

Product Parts Locations

See these sections to identify the parts on your product.

[Product Parts - Top](#)

[Product Parts - Front](#)

[Product Parts - Inside](#)

[Product Parts - Back](#)

Parent topic: [Product Basics](#)

Product Parts - Top

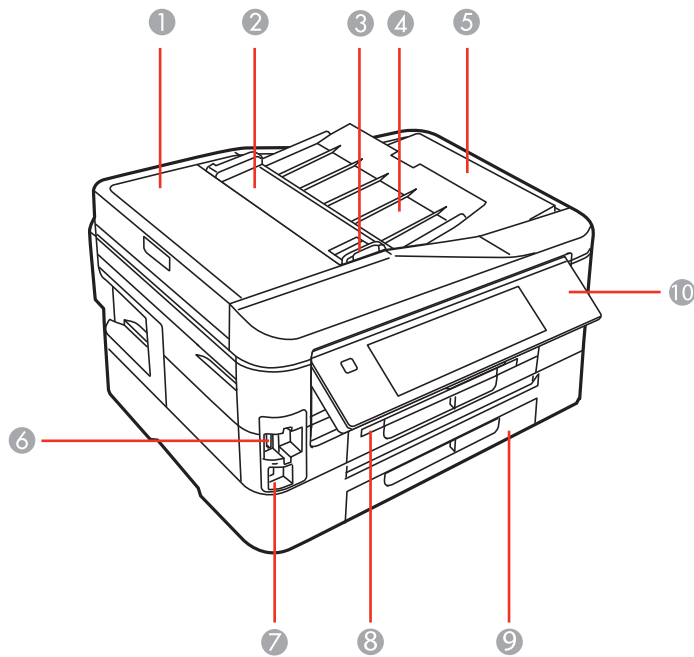

- 1 ADF cover
- 2 Automatic Document Feeder (ADF)
- 3 Edge guide

- 4 ADF paper support
- 5 ADF output tray
- 6 Memory card slots
- 7  USB Type A port for external devices
- 8 Paper cassette 1
- 9 Paper cassette 2
- 10 Control panel

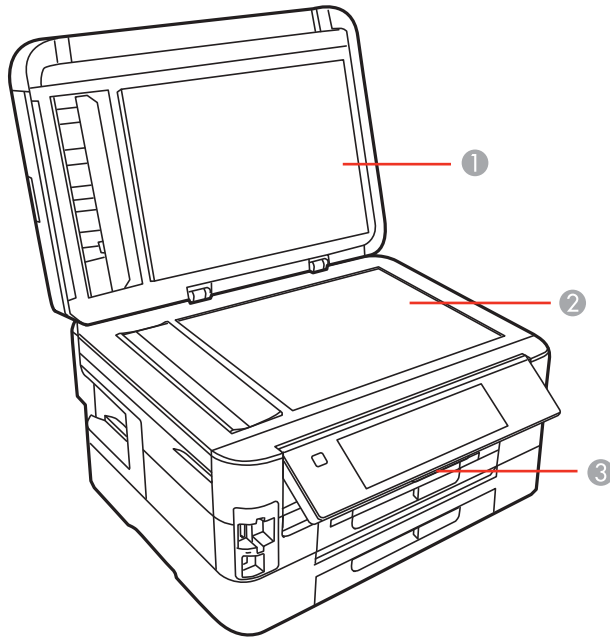

- 1 Document cover
- 2 Scanner glass
- 3 Release bar (beneath control panel)

Parent topic: [Product Parts Locations](#)

Product Parts - Front

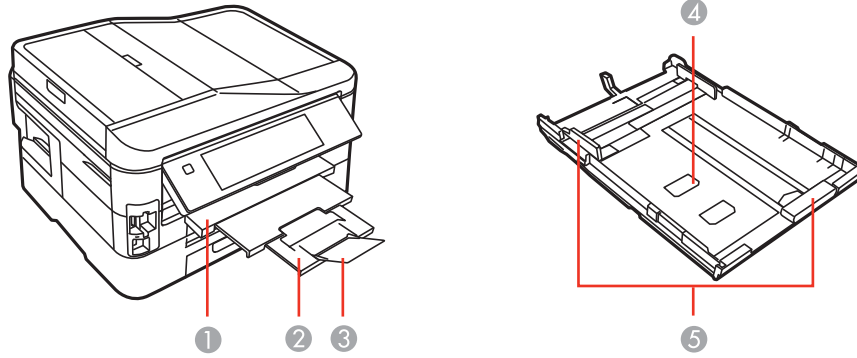

- 1 Output tray
- 2 Output tray extension
- 3 Paper stopper
- 4 Paper cassette
- 5 Edge guides

Parent topic: [Product Parts Locations](#)

Product Parts - Inside

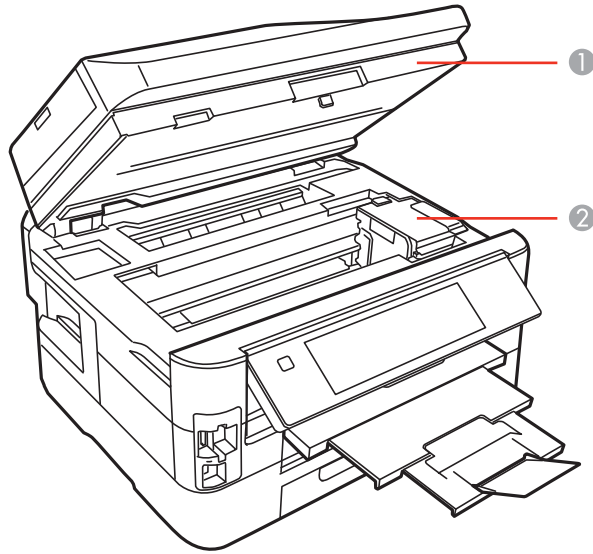

- 1 Scanner unit
- 2 Ink cartridge holder

Parent topic: [Product Parts Locations](#)

Product Parts - Back

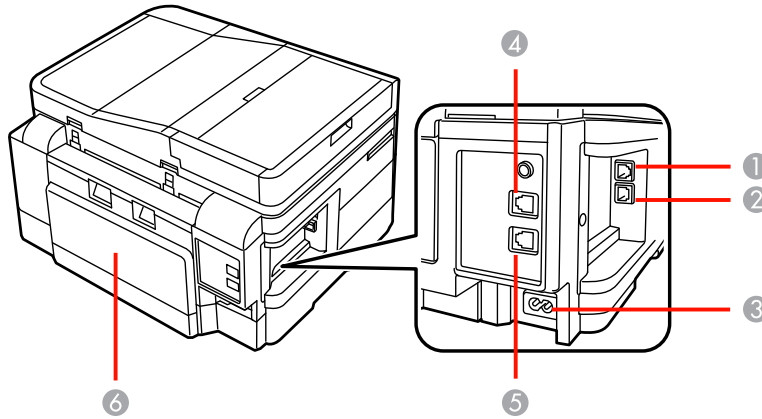

- 1 **LAN** port
- 2 **USB** port
- 3 AC inlet
- 4 **LINE** port
- 5 **EXT** port
- 6 Auto duplexer

Parent topic: [Product Parts Locations](#)



Two-Sided Printing, Scanning, Copying, and Faxing

You can print on both sides of the page automatically, using the product's built-in duplexer. By loading your pages in the automatic document feeder (ADF), you can also scan, copy, and fax double-sided documents.

Note: You can also print double-sided manually. With Windows, you can select the **2-Sided Printing** option in the driver to help you with manual double-sided printing.

- To print on both sides of the page from your computer, load plain paper or EPSON Bright White Paper, and select **2-Sided Printing** (Windows) or one of the **Two-sided Printing** settings (Mac OS X).

Note: If you are using EPSON Premium Presentation Paper Matte Double-sided or EPSON Brochure & Flyer Paper Matte Double-sided you must print double-sided manually; this type of paper is not designed to work with the duplexer.

- To scan a double-sided document in the ADF, press the **Scan** button and select your scanning method. If you selected a **Scan to PC** option, additionally press the  menu button and select **Scan settings**. Then select one of the **2-Sided** settings. If you are using the EPSON Scan software, select **ADF - Double-sided** as the Document Source (Office or Professional Modes only).
- To copy a double-sided document in the ADF, press the **Copy** button, then press the  menu button. Select **Paper and Copy Settings**, then select one of the **2-Sided Printing** settings.
- To fax a double-sided document in the ADF, press the **Fax** button, then press the  menu button. Select **Fax Send Settings**, then select one of the **2-Sided Scanning** settings.

Parent topic: [Product Basics](#)

Selecting Wireless Network Settings From the Touch Panel

You can select or change wireless network settings using your product touch panel.

To install your product on a wireless network, follow the instructions on the *Start Here* sheet and install the necessary software from the product CD. The installer program guides you through network setup.

1. Press the  home button, if necessary.
2. Press the arrow buttons and then select **Setup**.
3. Press the arrow buttons and then select **Network Settings**.
4. Select **Wireless LAN Setup**.

You see this screen:

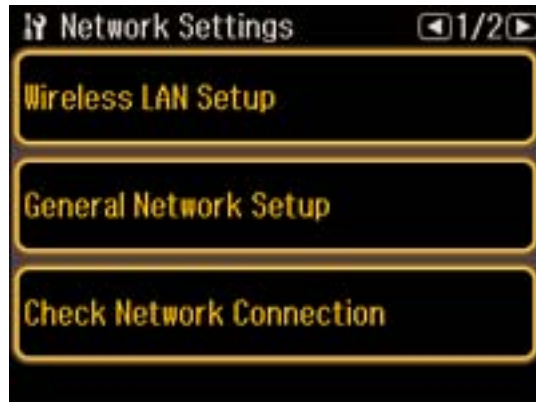

5. Select **Setup Wizard**.





Note: If you need to disable the wireless network to set up your product on an Ethernet network, press the arrow buttons and select **Disable Wireless LAN** instead. Then follow the instructions on the *Start Here* sheet to set up your product on a wired network and install the necessary software from the product CD. The installer program guides you through network setup.

6. Select the name of your wireless network or enter the name manually.

Note: To enter the wireless network name manually, press the arrow buttons and then select **Other SSIDs**. Use the displayed keypad to enter your network name, as described in the next step.

7. Enter your wireless password (or network name and then password) using the displayed keypad.



- Press the up or down arrow buttons to select a character.
 - Press the left or right arrow buttons to move the cursor to the previous or next space.
 - Press the  menu button to select uppercase letters (ABC), lowercase letters (abc), or numbers (123) and symbols (*!#&).
 - To delete characters, select .
 - When you finish entering characters, press the **OK** button.
8. Confirm the displayed network settings and press the **OK** button to save them.
 9. If you want to print a network setup report, press the  start button. (Otherwise, select **Cancel**.)
 10. Press the  home button to exit.

Note: If you need to change a setting, press the  back button.

The WiFi light should now be on, but not flashing.

Note: If the WiFi light is off, you may have selected the wrong network name or entered the password incorrectly. Repeat these steps to try again.

Parent topic: [Product Basics](#)

Loading Paper

Before you print, load paper for the type of printing you will do.

[Loading Plain Paper in the Cassette](#)

[Loading Photo Paper in Cassette 1](#)

[Loading Envelopes](#)

[Paper Loading Capacity](#)

[Available EPSON Papers](#)

[Paper or Media Type Settings](#)

[Borderless Paper Type Compatibility](#)

Loading Plain Paper in the Cassette

You can load plain paper in a variety of sizes in the paper cassette.

Note: You can load custom paper sizes into Cassette 1 only.

1. Close the output tray, if necessary.

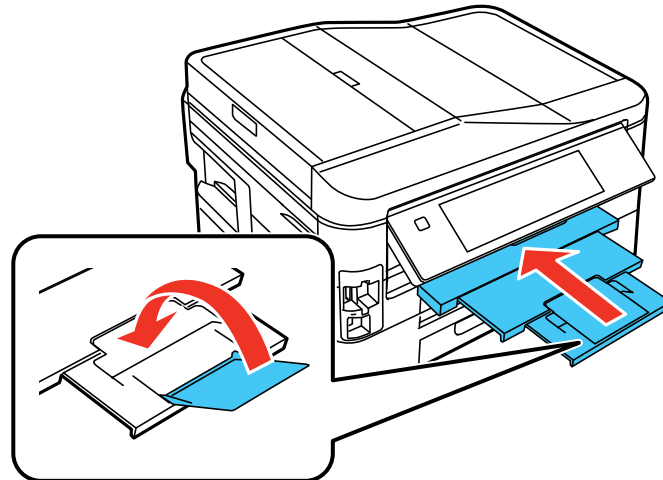

2. Pull out the paper cassette.

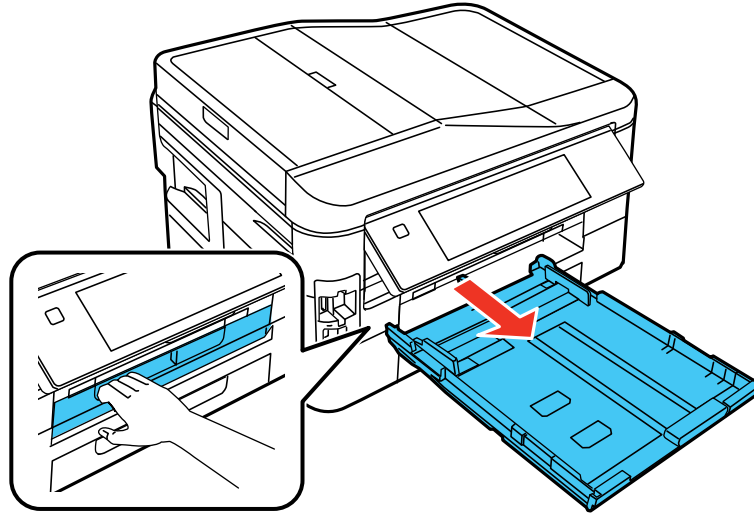

3. Slide the edge guides outward.

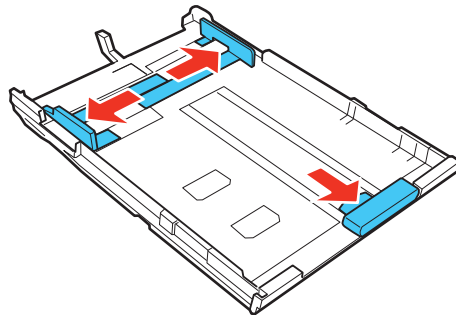

Note: If you are using legal-size paper, press the button to extend the paper cassette.

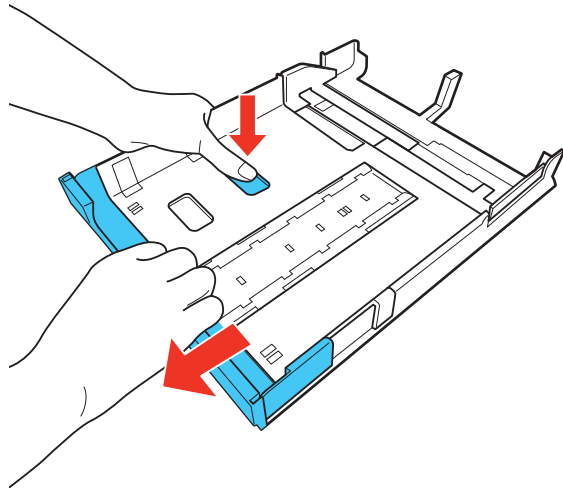

4. Load a stack of paper, printable side down, in the cassette as shown.

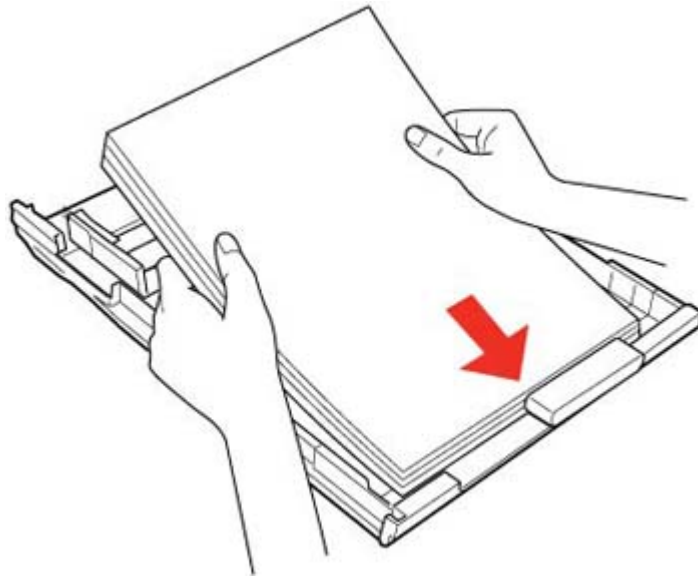

5. Slide the edge guides against the paper, but not too tight.

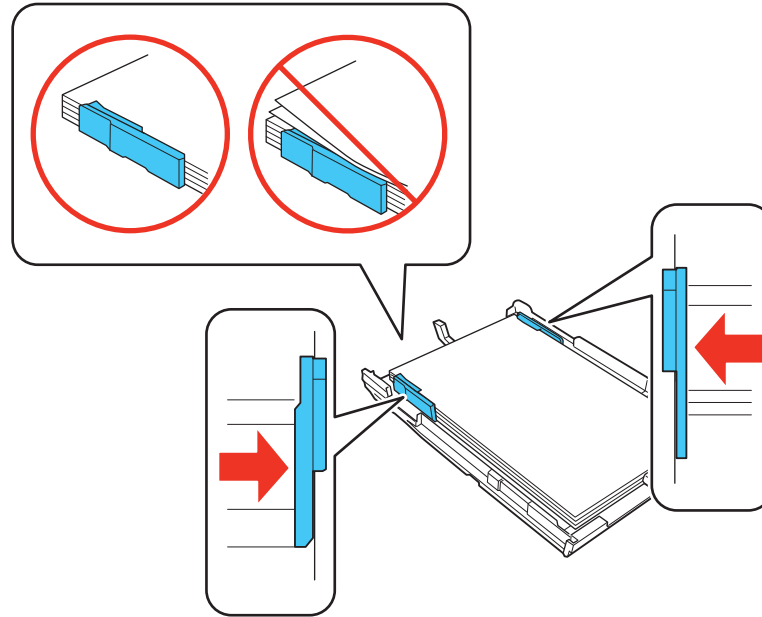

Note: Make sure the paper fits beneath the top edges of the guide, and is not sticking out from the end of the cassette.

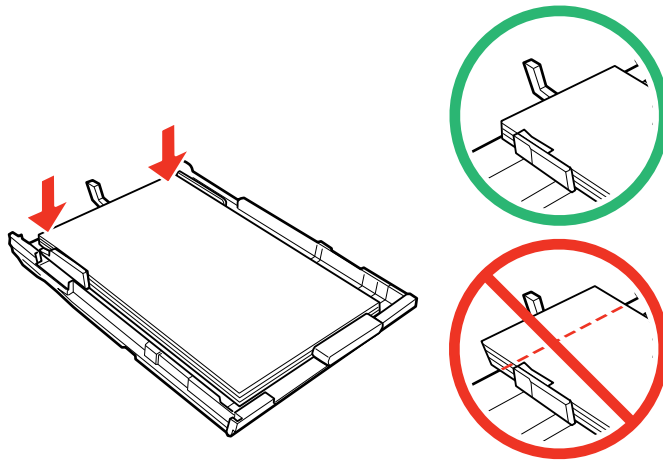

Caution: To prevent paper feeding problems, make sure you do not load too much paper in the cassette.

6. Gently replace the paper cassette.

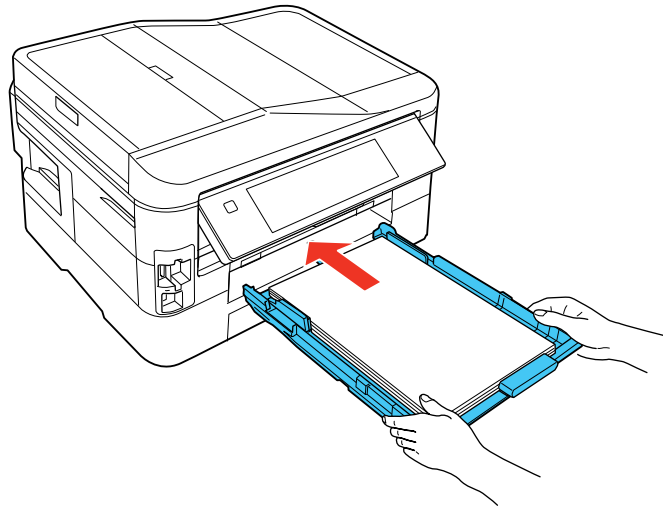

7. Extend the output tray and open the paper stopper.

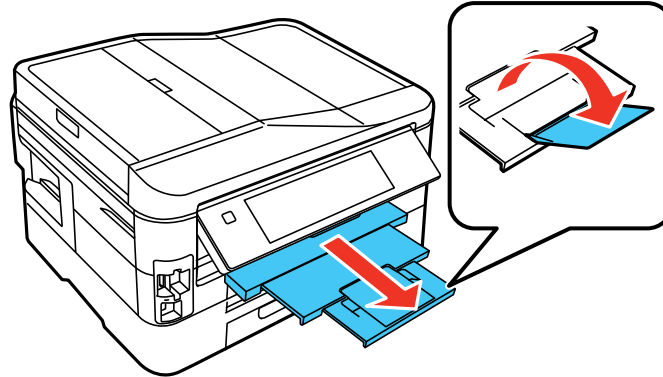

Note: If you are using legal-size or longer paper, do not open the paper stopper. Do not remove or insert the paper cassette during printing.

Parent topic: [Loading Paper](#)

Related references

[Paper Loading Capacity](#)

Related tasks

[Loading Photo Paper in Cassette 1](#)

[Loading Envelopes](#)

Loading Photo Paper in Cassette 1

You can print photos on a variety of paper types and sizes.

Note: You can load photo paper and custom paper sizes only into Cassette 1.

1. Close the output tray, if necessary.

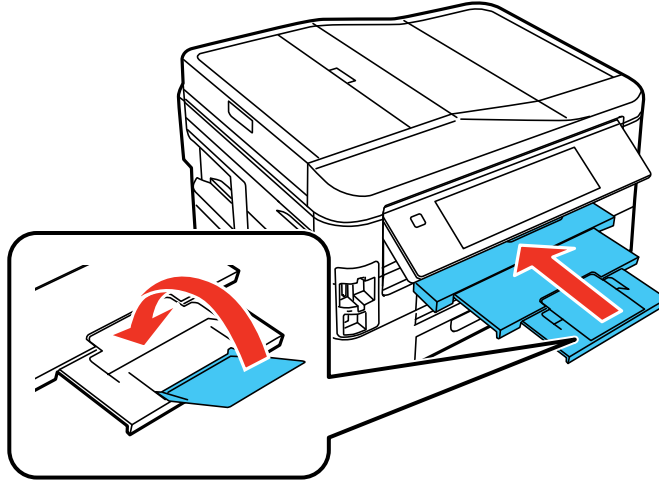

2. Pull out paper cassette 1.

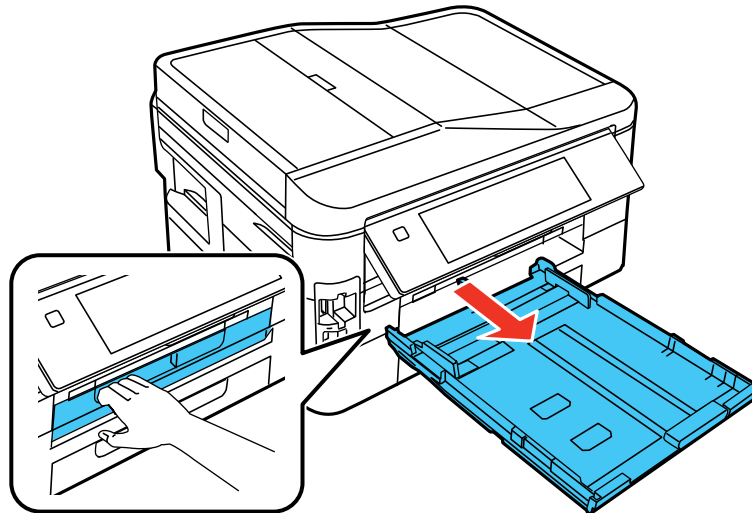

3. Slide the edge guides outward.

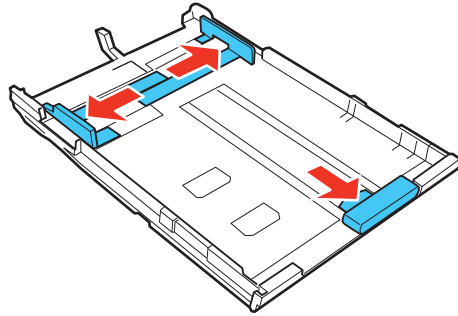

4. Slide the edge guide shown below to your paper size.

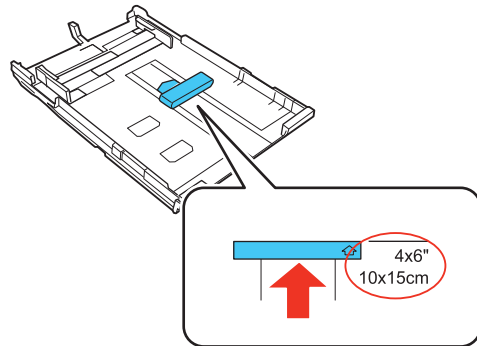

5. Load photo paper, printable side down, against the edge guide as shown.

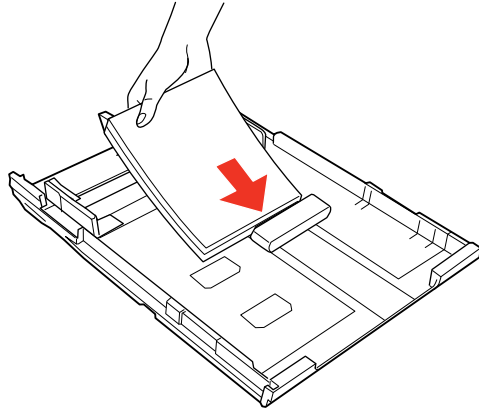

Note: Make sure the paper is loaded against the edge guide and not sticking out from the end of the cassette.

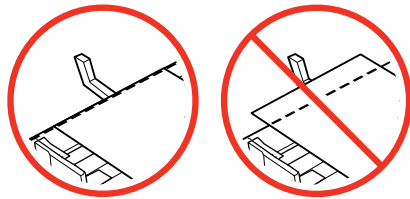

6. Slide the edge guides against the paper, but not too tight.

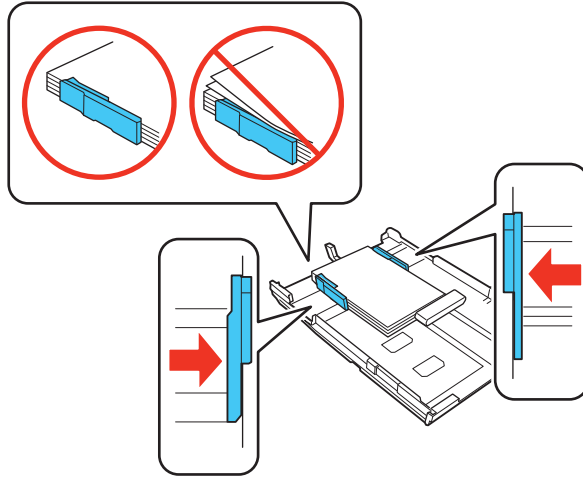

Note: Make sure the paper fits beneath the top edges of the guide.

Caution: To prevent paper feeding problems, make sure you do not load too much paper in the cassette.

7. Gently replace paper cassette 1.

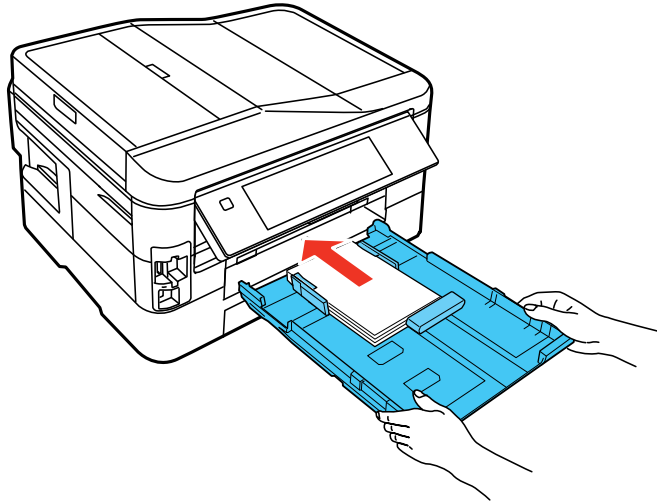

Note: The paper may slide forward slightly as you insert the cassette. This is normal.

8. Extend the output tray and open the paper stopper.

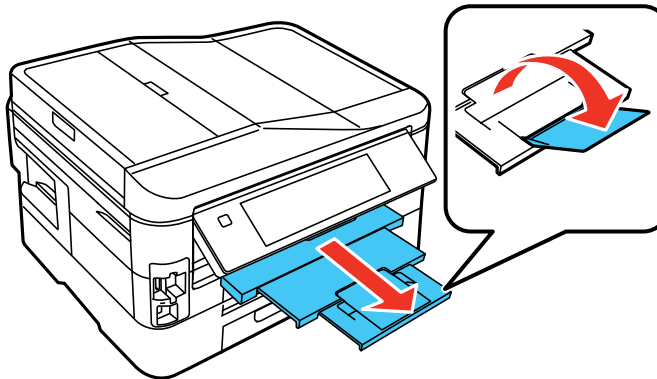

Always follow these paper loading guidelines:

- Load only the recommended number of sheets.

- Load paper short edge first, no matter which way your document faces.
- Do not load paper above the arrow mark inside the edge guide.
- Check the paper package for any additional loading instructions.

Parent topic: [Loading Paper](#)

Related references

[Paper Loading Capacity](#)

Related tasks

[Loading Plain Paper in the Cassette](#)

[Loading Envelopes](#)

Loading Envelopes

You can print on plain paper envelopes in this size: No. 10 (4.1 × 9.5 inches [105 × 241 mm]).

Note: You can load No. 10 and custom size envelopes only into Cassette 1.

1. Close the output tray, if necessary.

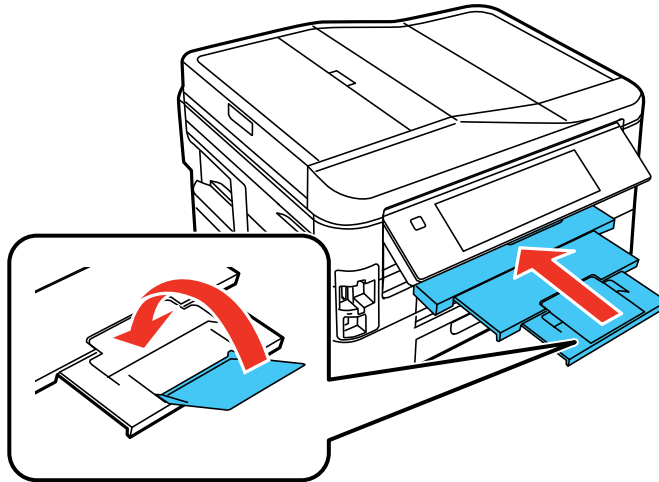

2. Pull out paper cassette 1.

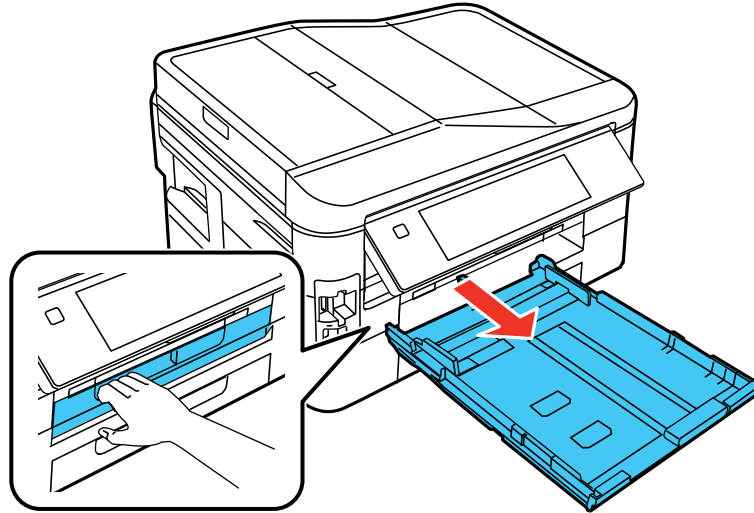

3. Slide the edge guide shown below to your envelope size.

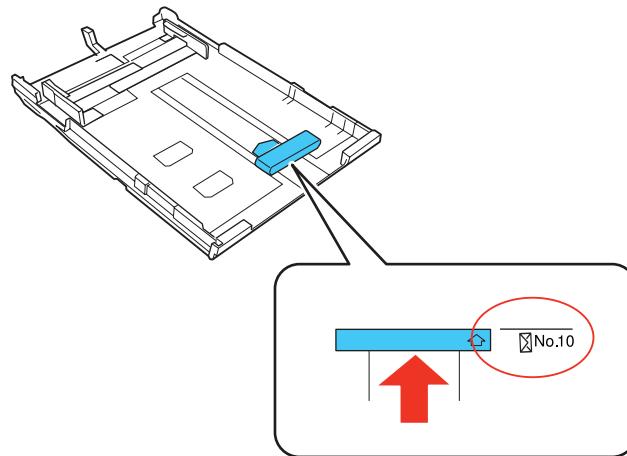

4. Insert envelopes, with printable side down and flap edge left, in the center of the tray.

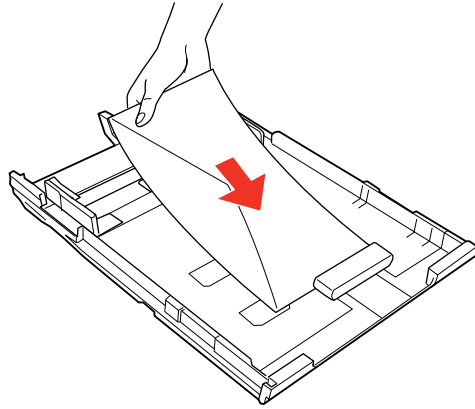

5. Slide the edge guides against the envelopes, but not too tightly.

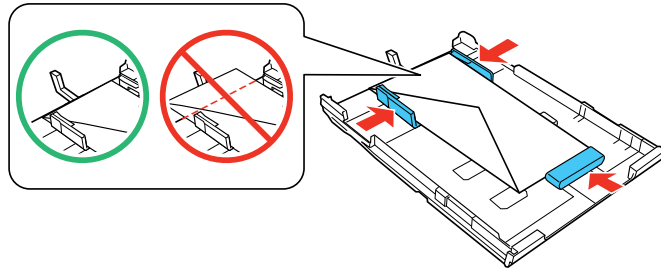

Note: Make sure the envelopes fit beneath the top edges of the guides, and are not sticking out from the end of the cassette.

Always follow these envelope loading guidelines:

- If you have trouble loading a stack of envelopes, press each envelope flat before loading it or load one envelope at a time.
- If print quality declines when printing multiple envelopes, try loading one envelope at a time.
- Do not load envelopes that are curled, folded, or too thin.

Parent topic: [Loading Paper](#)

Related references[Paper Loading Capacity](#)**Related tasks**[Loading Plain Paper in the Cassette](#)[Loading Photo Paper in Cassette 1](#)

Paper Loading Capacity

Note: For custom paper sizes, load one sheet in Cassette 1.

Paper type	Loading capacity - paper cassette
Plain paper	250 sheets Letter (8.5 × 11 inches [216 × 279 mm])
	250 sheets Legal (8.5 × 14 inches [216 × 357 mm])
EPSON Bright White Paper	200 sheets
EPSON Presentation Paper Matte	80 sheets
EPSON Premium Presentation Paper Matte EPSON Premium Presentation Paper Matte Double-sided EPSON Brochure & Flyer Paper Matte Double-sided EPSON Photo Paper Glossy EPSON Premium Photo Paper Glossy EPSON Ultra Premium Photo Paper Glossy EPSON Premium Photo Paper Semi-gloss	20 sheets
EPSON Iron-on Cool Peel Transfer paper EPSON Photo Quality Self-adhesive Sheets	1 sheet
Envelopes	10 envelopes

Parent topic: [Loading Paper](#)

Available EPSON Papers

You can purchase genuine EPSON ink and paper at EPSON Supplies Central at www.epson.com/ink3 (U.S. sales) or www.epson.ca (Canadian sales). You can also purchase supplies from an EPSON authorized reseller. To find the nearest one, call 800-GO-EPSON (800-463-7766).

Paper Type	Size	Part number	Sheet count
EPSON Bright White Paper	Letter (8.5 × 11 inches [216 × 279 mm])	S041586	500
EPSON Photo Paper Glossy	4 × 6 inches (102 × 152 mm)	S041809	50
		S042038	100
	Letter (8.5 × 11 inches [216 × 279 mm])	S041141	20
		S041649	50
		S041271	100
EPSON Premium Photo Paper Glossy	4 × 6 inches (102 × 152 mm)	S041808	40
		S041727	100
	5 × 7 inches (127 × 178 mm)	S041464	20
	8 × 10 inches (203 × 254 mm)	S041465	20
	Letter (8.5 × 11 inches [216 × 279 mm])	S042183	25
		S041667	50
EPSON Ultra Premium Photo Paper Glossy	4 × 6 inches (102 × 152 mm)	S042181	60
		S042174	100
	5 × 7 inches (127 × 178 mm)	S041945	20
	8 × 10 inches (203 × 254 mm)	S041946	20
	Letter (8.5 × 11 inches [216 × 279 mm])	S042182	25
		S042175	50
EPSON Premium Photo Paper Semi-gloss	4 × 6 inches (102 × 152 mm)	S041982	40
	Letter (8.5 × 11 inches [216 × 279 mm])	S041331	20

Paper Type	Size	Part number	Sheet count
EPSON Presentation Paper Matte	Letter (8.5 × 11 inches [216 × 279 mm])	S041062	100
	Legal (8.5 × 14 inches [216 × 357 mm])	S041067	100
EPSON Premium Presentation Paper Matte	8 × 10 inches (203 × 254 mm)	S041467	50
	Letter (8.5 × 11 inches [216 × 279 mm])	S041257 S042180	50 100
EPSON Premium Presentation Paper Matte Double-sided	Letter (8.5 × 11 inches [216 × 279 mm])	S041568	50
EPSON Iron-on Cool Peel Transfer paper	Letter (8.5 × 11 inches [216 × 279 mm])	S041153	10
EPSON Brochure & Flyer Paper Matte Double-sided	Letter (8.5 × 11 inches [216 × 279 mm])	S042384	150
EPSON Photo Quality Self-adhesive Sheets	A4 (8.3 × 11.7 inches [210 × 297 mm])	S041106	10

Parent topic: [Loading Paper](#)

Paper or Media Type Settings

For this paper	Select this paper Type or Media Type setting
Plain paper EPSON Bright White Paper EPSON Presentation Paper Matte EPSON Photo Quality Self-adhesive Sheets EPSON Iron-on Cool Peel Transfer paper	Plain Paper/Bright White Paper
EPSON Ultra Premium Photo Paper Glossy	Ultra Premium Photo Paper Glossy
EPSON Premium Photo Paper Glossy	Premium Photo Paper Glossy
EPSON Photo Paper Glossy	Photo Paper Glossy
EPSON Premium Photo Paper Semi-gloss	Premium Photo Paper Semi-Gloss

For this paper	Select this paper Type or Media Type setting
EPSON Premium Presentation Paper Matte EPSON Premium Presentation Paper Matte Double-sided EPSON Brochure & Flyer Paper Matte Double-sided	Premium Presentation Paper Matte
Envelopes	Envelope
Cardstock up to 68 lb (38.8 kg)	Thick-Paper

Parent topic: [Loading Paper](#)

Borderless Paper Type Compatibility

You can print borderless photos on compatible paper types in compatible sizes:

Borderless Paper Types

- EPSON Brochure & Flyer Paper Matte Double-sided
- EPSON Ultra Premium Presentation Paper Matte
- EPSON Premium Presentation Paper Matte
- EPSON Premium Presentation Paper Matte Double-sided
- EPSON Ultra Premium Photo Paper Glossy
- EPSON Premium Photo Paper Semi-gloss
- EPSON Premium Photo Paper Glossy
- EPSON Photo Paper Glossy

Borderless Paper Sizes

- 4 × 6 inches (102 × 152 mm)
- 5 × 7 inches (127 × 178 mm)
- 8 × 10 inches (203 × 254 mm)
- Letter (8.5 × 11 inches [216 × 279 mm])

Parent topic: [Loading Paper](#)

Placing Originals on the Product

Follow the instructions here to place your original documents or photos on the product.

Caution: Do not place anything on top of your product or use its cover as a writing surface to avoid damaging it.

[Placing Originals on the Scanner Glass](#)

[Placing Originals in the Automatic Document Feeder](#)

Placing Originals on the Scanner Glass

You can place originals up to this size on the scanner glass: Letter (8.5 × 11 inches [216 × 279 mm]) or A4 (8.3 × 11.7 inches [210 × 297 mm]).

1. Open the document cover.
2. Place your original facedown on the scanner glass with the top facing as shown. Slide the original to the edges of the indicated corner.

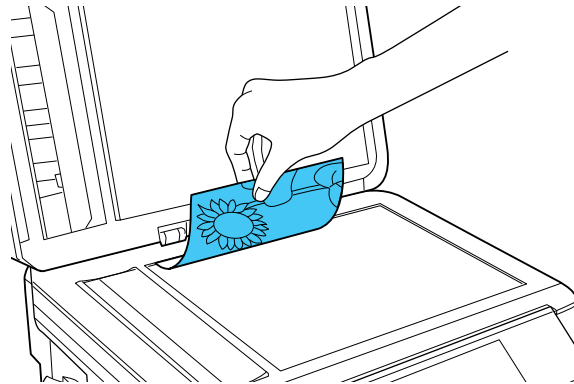

Note: You can place multiple originals on the scanner glass. Just make sure they are at least 0.2 inch (5 mm) away from each other.

3. Close the document cover gently to keep your original in place.

Parent topic: [Placing Originals on the Product](#)

Related topics

[Copying](#)

[Scanning](#)

[Faxing](#)

Placing Originals in the Automatic Document Feeder

You can place multi-page original documents in the Automatic Document Feeder (ADF). Make sure the originals meet the Automatic Document Feeder specifications before loading them.

Caution: Make sure your originals are not creased or folded, and do not contain holes, staples, tape, or other materials that could obstruct the feeder.

1. Open the ADF paper support.

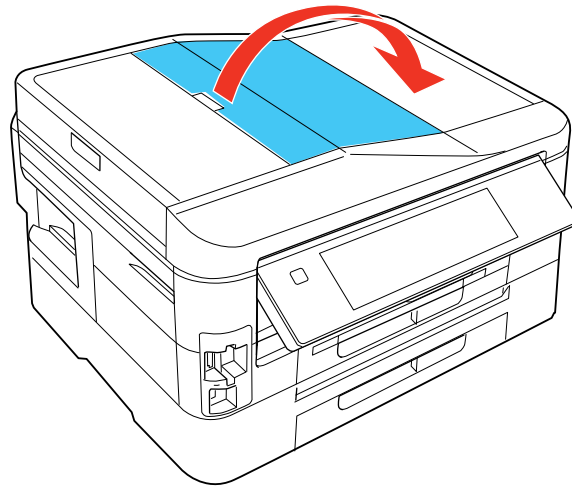

2. Slide the ADF edge guide outward.

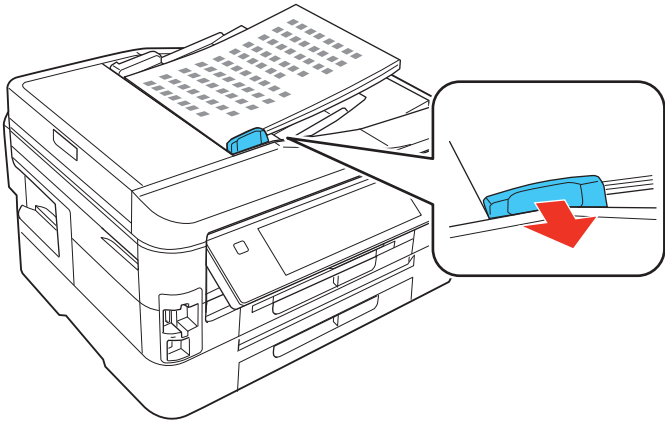

3. Fan your stack of originals and tap them gently on a flat surface to even the edges.

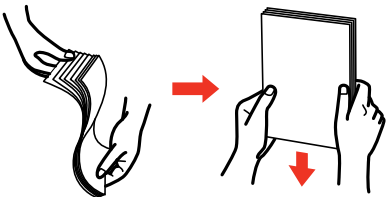

4. Insert the originals into the ADF faceup and top-edge first.

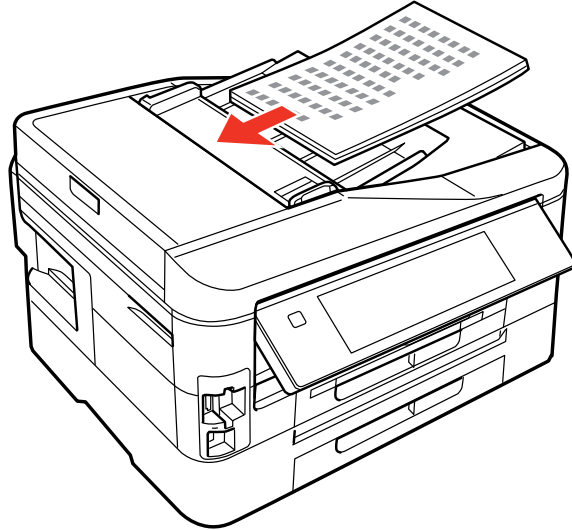

5. Slide the ADF edge guide against the originals, but not too tightly.

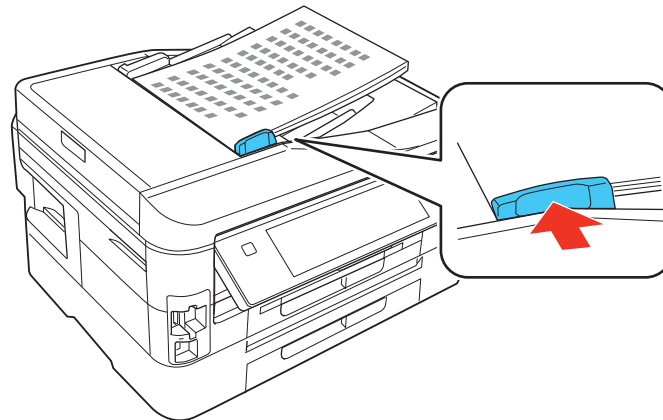

Note: If you're using the **2-up Copy** layout, make sure the originals are loaded as shown:

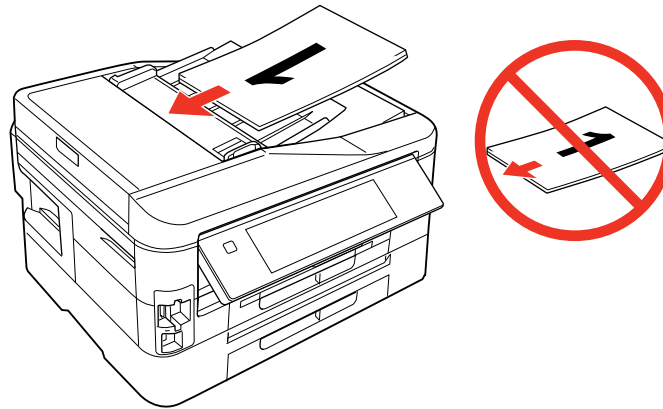
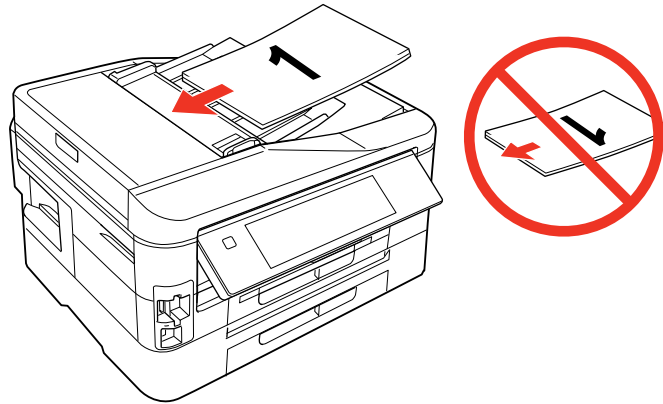

Parent topic: [Placing Originals on the Product](#)

Related topics

[Copying](#)

[Scanning](#)

[Faxing](#)

Copying

See the information here to copy documents or photos using your product.

Note: Copies may not be exactly the same size as your originals.

[Copying Documents or Photos](#)

[Paper Type Settings - Copying](#)

[Paper Size Settings - Copying](#)

[Copying Options](#)

Related topics

[Placing Originals on the Product](#)

Copying Documents or Photos

You can copy documents or photos onto various sizes and types of paper, including Epson special papers.



1. Place your original document or photo on the scanner glass, or place multi-page documents in the ADF.
2. Load the paper you want to print on.

Note: Load only the recommended number of sheets.

3. Press the **Copy** button.

You see this screen:



4. To print more than one copy, press the **+** button to select the number (up to 99).
5. Select **Color** or **B&W** (black and white) copies.
6. If you need to adjust the darkness of your copy, press the arrow buttons to change the **Density** setting.
7. To change any of the print settings displayed on the LCD screen, press the  menu button, select **Paper and Copy Settings**, select the necessary settings, and press the **OK** button..
8. When you are ready to copy, press the  start button.

Note: To cancel printing, select **Cancel**.

Parent topic: [Copying](#)

Paper Type Settings - Copying

Select a **Paper Type** setting that matches the paper you loaded.

Paper type loaded	Paper Type setting
Plain paper EPSON Bright White Paper EPSON Presentation Paper Matte EPSON Iron-on Cool Peel Transfer paper EPSON Photo Quality Self-adhesive Sheets	Plain Paper
EPSON Premium Presentation Paper Matte EPSON Ultra Premium Presentation Paper Matte EPSON High Quality Ink Jet Paper EPSON Brochure & Flyer Paper Matte Double-sided	Matte
EPSON Premium Photo Paper Glossy EPSON Premium Photo Paper Semi-gloss EPSON Ultra Premium Photo Paper Luster	Prem. Glossy
EPSON Ultra Premium Photo Paper Glossy	Ultra Glossy
EPSON Photo Paper Glossy	Glossy

Parent topic: [Copying](#)

Related topics

[Placing Originals on the Product](#)

[Loading Paper](#)

Paper Size Settings - Copying

Select the **Paper Size** setting that matches the paper you loaded.

- 4 x 6 inches (102 x 152 mm)
- 5 x 7 inches (127 x 178 mm)
- 8 x 10 inches (203 x 254 mm)
- Letter (8.5 x 11 inches [216 x 279 mm])
- Legal (8.5 x 14 inches [216 x 357 mm])
- A4 (8.3 x 11.7 inches [210 x 297 mm])

Parent topic: [Copying](#)

Related topics

[Placing Originals on the Product](#)

[Loading Paper](#)

Copying Options

Select the **Paper and Copy Settings** options you want to use for your copies.

Note: Not all options or settings may be available, depending on other copying settings.

Copying option	Available settings	Description
Layout	With Border	Leaves a small margin around the image
	2-up Copy	Copies 2 originals on a single sheet
	Borderless	Expands the image to the edge of the paper (slight cropping may occur)
2-Sided Printing	On	Uses the duplexer to make 2-sided copies
	Off	
	1>1-Sided	Uses the duplexer and ADF to make 2-sided copies
	1>2-Sided	
	2>1-Sided	
	2>2-Sided	
Reduce/Enlarge	Custom Size	Automatically sizes the image by the percentage you select
	Actual Size	Copies at 100% size, unless you select a different percentage as the Custom Size setting
	Auto Fit Page	Automatically sizes the image to fit the selected paper size setting
	Legal->Letter and other conversions	Automatically converts from one size to another

Copying option	Available settings	Description
Paper Source	Cassette 1	Selects the paper in cassette 1 as the paper source
	Cassette 2	Selects the paper in cassette 2 as the paper source
	Cassette 1 then 2	Selects the paper in cassette 1 as the paper source, automatically switches to cassette 2 when cassette 1 is empty
Quality	Draft	Provides lower quality for draft copies (plain paper only)
	Standard Quality	Provides good quality for most copies
	Best	Provides the highest quality for special copies
Binding Direction	Portrait, Left Edge	Specifies the orientation of your originals (only available when 2>1-Sided is selected)
	Portrait, Top Edge	
	Landscape, Left Edge	
	Landscape, Top Edge	
Dry Time	Standard	Provides longer drying time for 2-sided copies, if smudges or marks appear on the front of the paper when you print on the second side.
	Long	
	Longer	
Expansion	Standard	Adjusts the amount of expansion for printing borderless photos
	Medium	
	Minimum	

Parent topic: [Copying](#)

Related topics

[Placing Originals on the Product](#)

[Loading Paper](#)

Printing From a Computer

Before printing documents or photos from your computer, make sure you have set up your product and installed its software as described on the *Start Here* sheet.

Note: If you have an internet connection, it is a good idea to check for updates to your product software on Epson's support website.

[Printing with Windows](#)

[Printing with Mac OS X 10.5, 10.6, or 10.7](#)

[Printing with Mac OS X 10.4](#)

[Cancelling Printing Using a Product Button](#)

Related tasks

[Checking for Software Updates](#)

Printing with Windows

You can print with your product using any Windows printing program, as described in these sections.

[Selecting Basic Print Settings - Windows](#)

[Selecting Double-sided Printing Settings - Windows](#)

[Selecting Additional Layout and Print Options - Windows](#)

[Selecting a Printing Preset - Windows](#)

[Printing Your Document or Photo - Windows](#)

[Selecting Default Print Settings - Windows](#)

[Changing Automatic Update Options](#)

Parent topic: [Printing From a Computer](#)

Selecting Basic Print Settings - Windows

Select the basic settings for the document or photo you want to print.

1. Open a photo or document for printing.
2. Select the print command in your application.

Note: You may need to select a print icon on your screen, the **Print** option in the **File** menu, or another command. See your application's help utility for details.

3. If necessary, select your product name as the printer you want to use.

Note: You may also need to select **Properties** or **Preferences** to view your print settings.

You see the Main tab of your printer settings window:

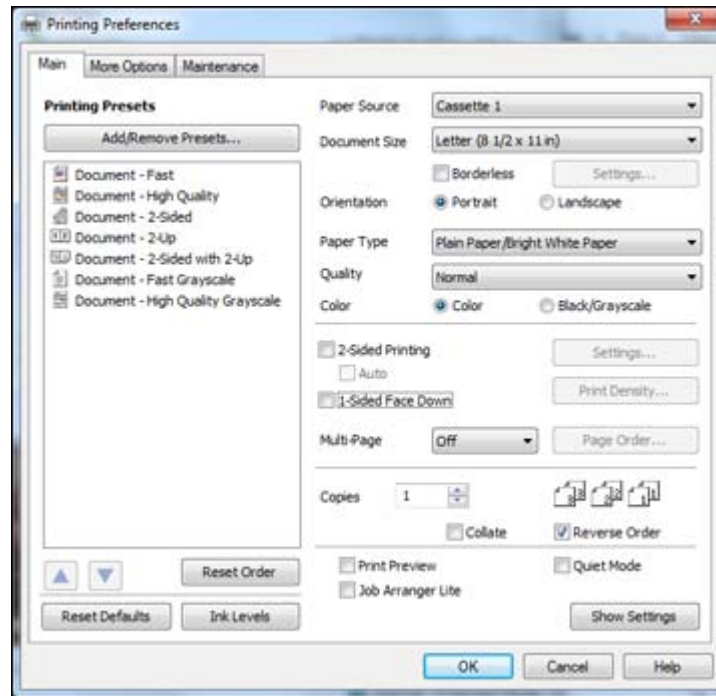

4. Select the **Paper Source** setting that indicates where you loaded the paper you want to print on.
5. Select the size of the paper you loaded as the **Document Size** setting.

Note: You can also select the **User Defined** setting to create a custom paper size for Cassette 1.

6. Select the orientation of your document.

Note: If you are printing an envelope, select **Landscape**.

7. Select the type of paper you loaded as the **Paper Type** setting.

Note: Check the paper type settings list for details.

8. Select the **Quality** setting that matches the print quality you want to use.
9. Select a Color option:
 - To print a color document or photo, select the **Color** setting.
 - To print text and graphics in black or shades of gray, select the **Black/Grayscale** setting.
10. To print on both sides of the paper, select the **2-Sided Printing** checkbox and select the options you want.
11. To print on one side of the paper and eject the printout facedown, select the **1-Sided Face Down** checkbox and select the options you want.
12. To print multiple pages on one sheet of paper, or print one image on multiple sheets of paper, select one of the settings in the **Multi-Page** menu and select the printing options you want.
13. To print multiple copies and arrange their print order, select the **Copies** options.
14. To preview your job before printing, select **Print Preview**.
15. To save your print job as a project that can be modified and combined with other print jobs, select **Job Arranger Lite**.
16. To reduce noise during printing when you select **Plain Paper/Bright White Paper**, select **Quiet Mode**.

[Paper Source Options - Windows](#)

[Print Quality Options - Windows](#)

[Multi-Page Printing Options - Windows](#)

Parent topic: [Printing with Windows](#)

Related references

[Paper or Media Type Settings](#)

Related tasks

[Printing Your Document or Photo - Windows](#)

Paper Source Options - Windows

You can select any of the available options in the Paper Source menu to print from paper loaded in that source.

Cassette 1

Selects the paper in cassette 1 as the paper source.

Cassette 2

Selects the paper in cassette 2 as the paper source.

Cassette 1 then 2

Selects the paper in cassette 1 as the paper source and automatically switches to cassette 2 when cassette 1 is empty.

Parent topic: [Selecting Basic Print Settings - Windows](#)

Print Quality Options - Windows

You can select any of the available Quality options to fine-tune the quality of your print. Some settings may be unavailable, depending on the paper type you have chosen.

Fast Economy

For the fastest printing with draft quality.

Economy

For fast printing with reduced quality.

Normal

For everyday text and image printing.

Fine

For text and graphics with good quality and print speed.

Quality

For photos and graphics with good quality and print speed.

High Quality

For photos and graphics with high print quality.

Best Quality

For the best print quality, but the slowest print speed.

Parent topic: [Selecting Basic Print Settings - Windows](#)

Multi-Page Printing Options - Windows

You can select any of the available options in the Multi-Page menu to set up your multi-page print job.

2-Up and 4-Up

Prints 2 or 4 pages on one sheet of paper. Click the **Page Order** button to select page layout and border options.

2x1 Poster, 2x2 Poster, 3x3 Poster, 4x4 Poster

Prints one image on multiple sheets of paper to create a larger poster. Click the **Settings** button to select image layout and guideline options.

Parent topic: [Selecting Basic Print Settings - Windows](#)

Selecting Double-sided Printing Settings - Windows

You can print on both sides of the paper by selecting the **2-Sided Printing** checkbox on the Main tab.



Note: Some options may be pre-selected or unavailable, depending on other settings you have chosen or if you are accessing the product over a network.

1. Select the **2-Sided Printing** checkbox.
2. If the **Auto** checkbox is not automatically selected, do one of the following:
 - Select the **Auto** checkbox to automatically print your double-sided print job.
 - Deselect the **Auto** checkbox to print your double-sided print job manually by printing one side and flipping the paper over to print the other side (recommended for paper types that do not support automatic duplexing).
3. Click the **Settings** button.

You see this window:

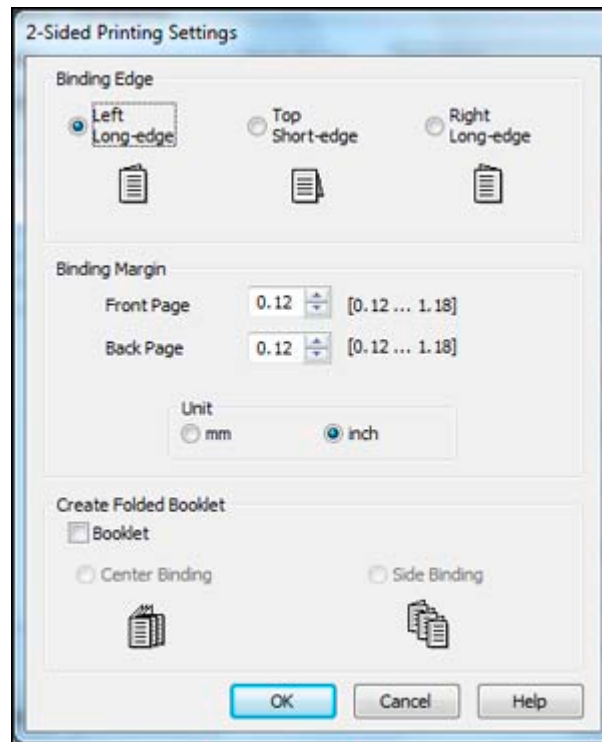

4. Select the double-sided printing options you want to use.
5. Click **OK** to return to the Main tab.
6. Click the **Print Density** button.

You see this window:

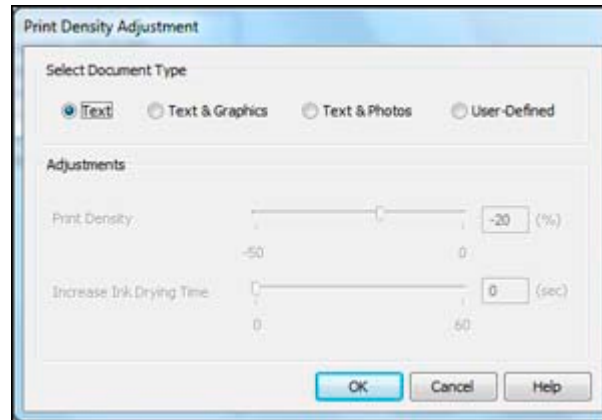

7. Select the type of document you are printing as the Document Type setting. The software automatically sets the **Adjustments** options for that document type.
8. If you selected the **User-Defined** document type, select the Adjustments options you want to use.
9. Click **OK** to return to the Main tab.
10. Print a test copy of your double-sided document to test the selected settings.
11. Follow any instructions displayed on the screen during printing.

[Double-sided Printing Options - Windows](#)

[Print Density Adjustments - Windows](#)

Parent topic: [Printing with Windows](#)

Double-sided Printing Options - Windows

You can select any of the available options on the 2-Sided Printing Settings window to set up your double-sided print job.

Binding Edge Options

Select a setting that orients double-sided print binding in the desired direction.

Binding Margin Options

Select options that define a wider margin to allow for binding.

Create Folded Booklet Options

Select the **Booklet** checkbox and a binding option to print double-sided pages as a booklet.

Parent topic: [Selecting Double-sided Printing Settings - Windows](#)

Print Density Adjustments - Windows

When you select the **User-Defined** setting, you can select any of the available options on the Print Density Adjustment window to adjust the print quality of your double-sided print job.

Print Density

Sets the level of ink coverage for double-sided printing.

Increase Ink Drying Time

Sets the amount of time required for drying ink after printing on one side of the paper before printing the other side in double-sided printing to prevent ink smearing.

Parent topic: [Selecting Double-sided Printing Settings - Windows](#)

Selecting Additional Layout and Print Options - Windows

You can select a variety of additional layout and printing options for your document or photo on the More Options tab.

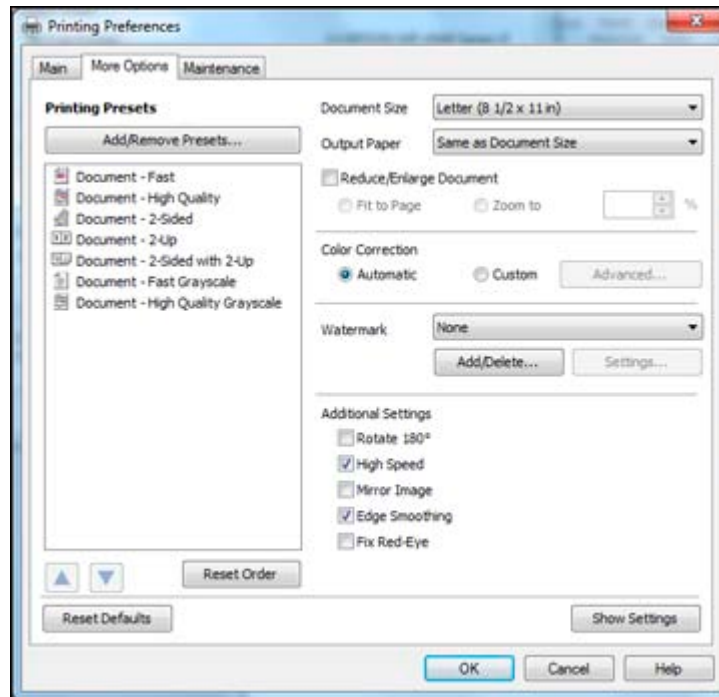

1. To change the size of your printed document or photo, select the **Reduce/Enlarge Document** checkbox and select one of these sizing options:
 - Select the **Fit to Page** option to size your image to fit the paper you loaded. Select the size of the your document or photo as the **Document Size** setting, and the size of your paper as the **Output Paper** setting.
 - Select the **Zoom to** option to reduce or enlarge your document or photo by a specific percentage. Select the percentage in the **%** menu.
2. Select one of the following Color Correction options:
 - Select **Automatic** to automatically adjust the sharpness, brightness, contrast, and color saturation for your image.
 - Select **Custom** and click the **Advanced** button to manually adjust the color correction settings or turn off color management in your printer software.
3. To add a watermark to your printout, select Watermark settings.
4. Select any of the Additional Settings options to customize your print.

[Custom Color Correction Options - Windows](#)

[Additional Settings Options - Windows](#)

Parent topic: [Printing with Windows](#)

Related tasks

[Printing Your Document or Photo - Windows](#)

Custom Color Correction Options - Windows

You can select any of the available options in the Color Correction window to customize the image colors for your print job.

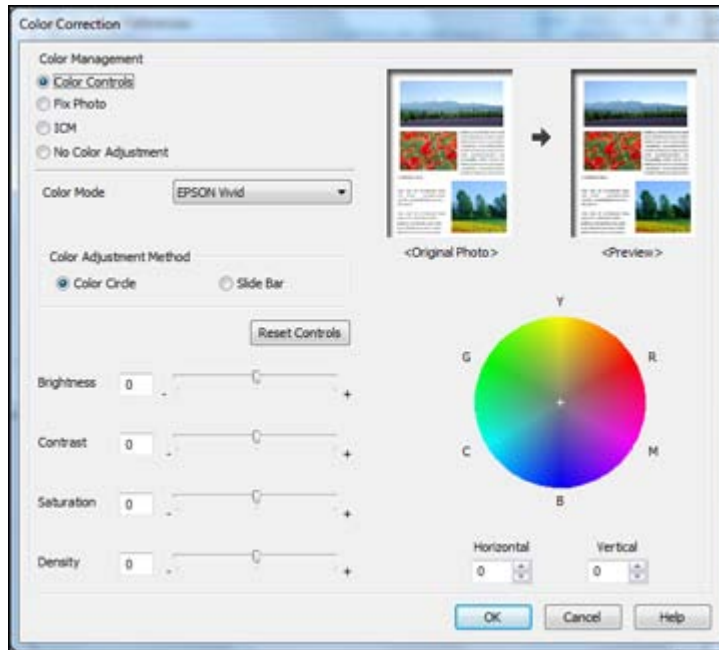

Color Controls

Lets you select a **Color Mode** setting, individual settings for **Brightness**, **Contrast**, **Saturation**, and **Density**, and individual color tones. If you select the **Adobe RGB** color mode, you can also adjust the midtone density using the **Gamma** setting.

Fix Photo

Improves the color, contrast, and sharpness of flawed photos.

Note: Fix Photo uses a sophisticated face recognition technology to optimize photos that include faces. For this to work, both eyes and the nose must be visible in the subject's face. If your photo includes a face with an intentional color cast, such as a statue, you may want to turn off **Fix Photo** to retain the special color effects.

ICM

Lets you manage color using installed color printing profiles.

No Color Adjustment

Turns off color management in your printer software so you can manage color using only your application software.

Parent topic: [Selecting Additional Layout and Print Options - Windows](#)

Additional Settings Options - Windows

You can select any of the Additional Settings options to customize your print. Some options may be pre-selected or unavailable, depending on other settings you have chosen.

Rotate 180°

Prints the image rotated 180° from its original orientation.

High Speed

Speeds up printing, but may reduce print quality.

Mirror Image

Flips the printed image left to right.

Edge Smoothing

Smooths jagged edges in low-resolution images such as screen captures or images from the Web.

Fix Red-Eye

Reduces or removes red-eye in photos.

Parent topic: [Selecting Additional Layout and Print Options - Windows](#)

Selecting a Printing Preset - Windows

For quick access to common groups of print settings, you can select a printing preset on the Main or More Options tab.

Note: You can create your own preset by clicking the **Add/Remove Presets** button.

1. Click the **Main** or **More Options** tab.
You see the available **Printing Presets** on the left:

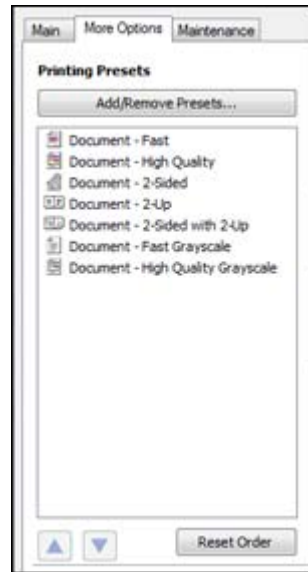

2. Place your cursor over one of the **Printing Presets** to view its list of settings.
3. Use any of the available options on the screen to control your printing presets.
4. To choose an option for printing, select it.
5. Click **OK**.

Parent topic: [Printing with Windows](#)

Printing Your Document or Photo - Windows

Once you have selected your print settings, you are ready to save your settings and print.

1. Click **OK** to save your settings.

You see your application's Print window, such as this one:

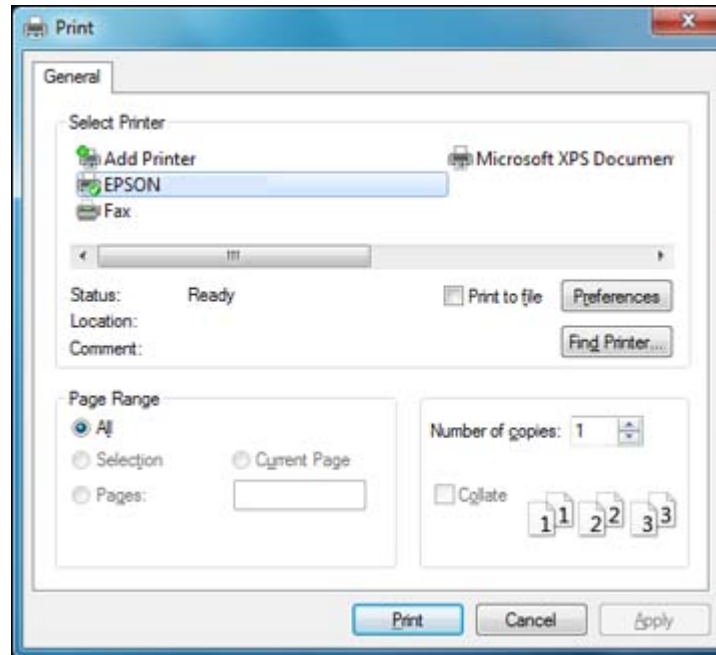

2. Click **OK** or **Print** to start printing.

Parent topic: [Printing with Windows](#)

Selecting Default Print Settings - Windows

When you change your print settings in a program, the changes apply only while you are printing in that program session. If you want to change the print settings you use in all your Windows programs, you can select new default print settings.

1. Right-click the product icon in the Windows taskbar.
2. Select **Printer Settings**.

You see the printer settings window:

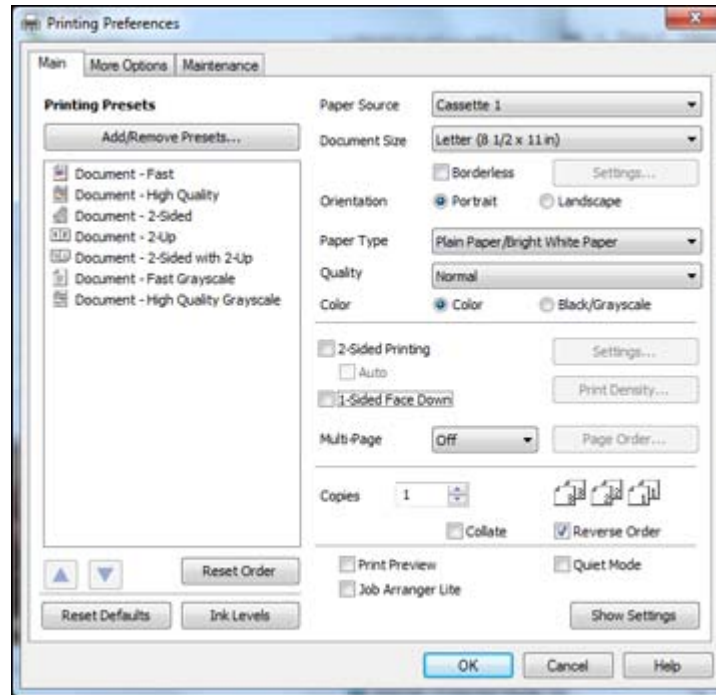

3. Select the print settings you want to use as defaults in all your Windows programs.

4. Click **OK**.

These settings are now the defaults selected for printing. You can still change them as needed for printing in any program session.

[Changing the Language of the Printer Software Screens](#)

Parent topic: [Printing with Windows](#)

Changing the Language of the Printer Software Screens

You can change the language used on the Windows printer software screens.

1. Right-click the product icon in the Windows taskbar.
2. Select **Printer Settings**.
You see the printer settings window.
3. Click the **Maintenance** tab.

You see the maintenance options:

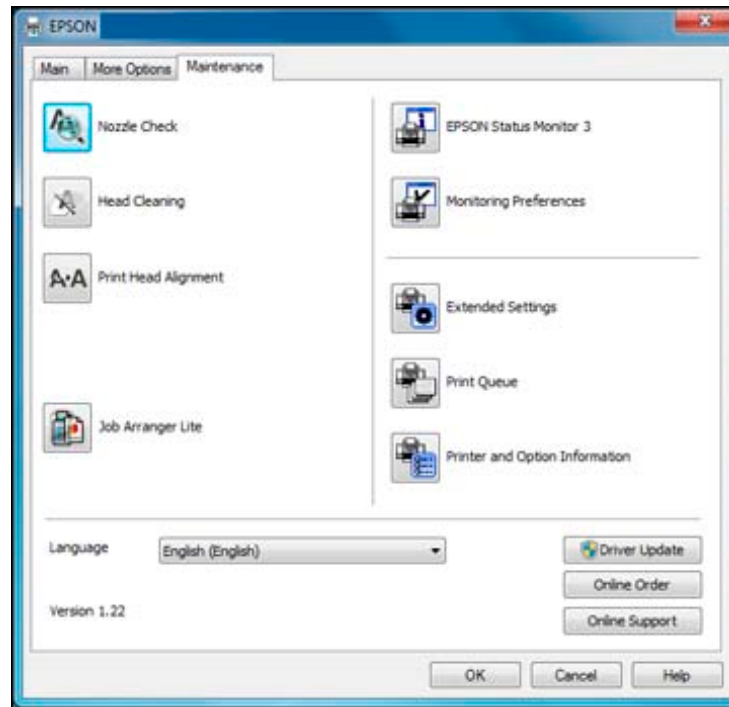

4. Select the language you want to use as the **Language** setting.
5. Click **OK** to close the printer software window.

The printer software screens appear in the language you selected the next time you access them.

Parent topic: [Selecting Default Print Settings - Windows](#)

Changing Automatic Update Options

Your printer software for Windows automatically checks for updates to the product driver and firmware. You can change how often the software checks for updates or disable this feature.

1. Right-click the product icon in the Windows taskbar.
2. Select **Auto Update Settings**.

You see a window like this:

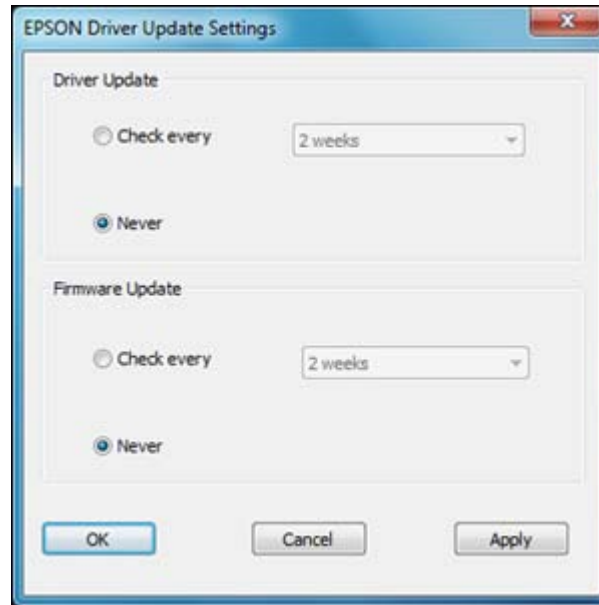

3. Do one of the following for each type of update:
 - To change how often the software checks for updates, select a setting in the **Check every** menu.
 - To disable the automatic update feature, select the **Never** option.
4. Click **Apply**.
5. Click **OK** to exit.

Note: If you choose to disable the automatic update feature, it's a good idea to periodically check for updates.

Parent topic: [Printing with Windows](#)

Related tasks

[Checking for Software Updates](#)

Printing with Mac OS X 10.5, 10.6, or 10.7

You can print with your product using any Mac OS X printing program, as described in these sections.

[Selecting Basic Print Settings - Mac OS X 10.5/10.6/10.7](#)

- [Selecting Page Setup Settings - Mac OS X 10.5/10.6/10.7](#)
- [Selecting Print Layout Options - Mac OS X 10.5/10.6/10.7](#)
- [Selecting Double-sided Printing Settings - Mac OS X 10.5/10.6/10.7](#)
- [Managing Color - Mac OS X 10.5/10.6/10.7](#)
- [Selecting Printing Preferences - Mac OS X 10.5/10.6/10.7](#)
- [Printing Your Document or Photo - Mac OS X 10.5/10.6/10.7](#)

Parent topic: [Printing From a Computer](#)

Selecting Basic Print Settings - Mac OS X 10.5/10.6/10.7

Select the basic settings for the document or photo you want to print.

1. Open a photo or document for printing.
2. Select the print command in your application.

Note: You may need to select a print icon on your screen, the **Print** option in the **File** menu, or another command. See your application's help utility for details.

3. Select your product as the **Printer** setting.

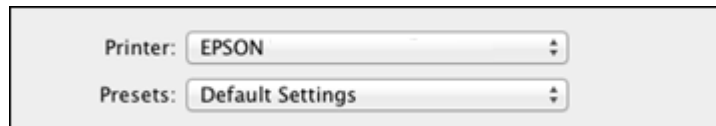

4. If necessary, click the arrow next to the Printer setting or the **Show Details** button to expand the print window.

You see the expanded printer settings window for your product:

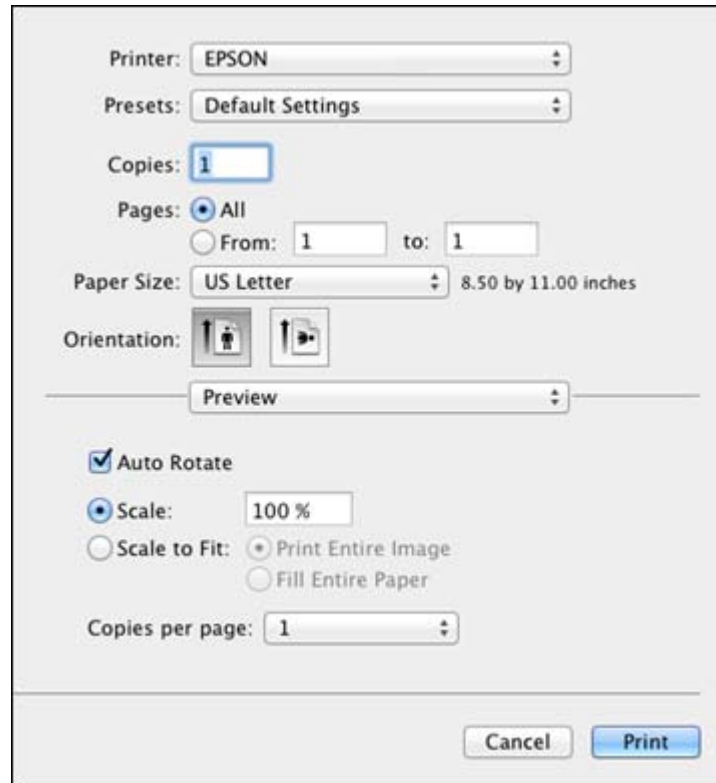

Note: The print window may look different, depending on the version of Mac OS X and the application you are using.

5. Select the **Copies** and **Pages** settings as necessary.

Note: If you do not see these settings in the print window, check for them in your application before printing.

6. Select the page setup options: **Paper Size** and **Orientation**.

Note: If you do not see these settings in the print window, check for them in your application before printing. They may be accessible by selecting **Page Setup** from the File menu.

7. Select any application-specific settings that appear on the screen, such as those shown in the image above for the Preview application.
8. Select **Print Settings** from the pop-up menu.

You see these settings:

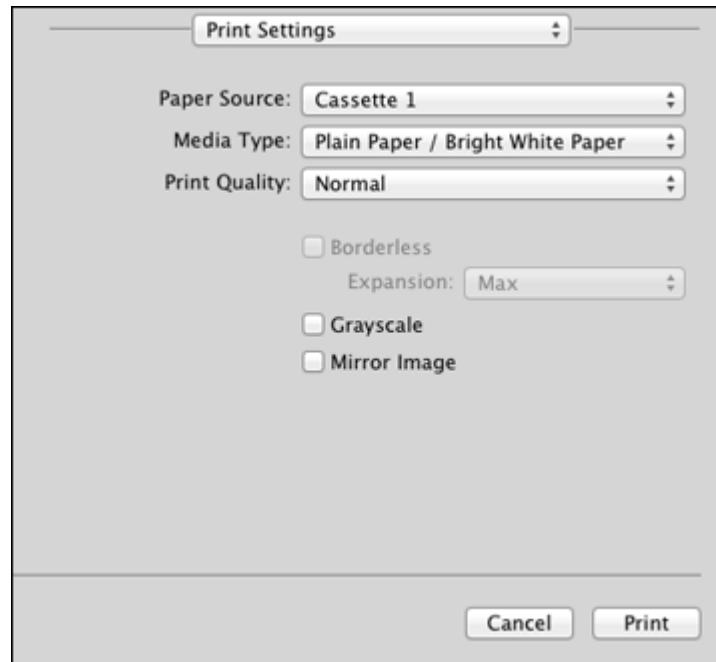

9. Select the **Paper Source** setting that indicates where you loaded the paper you want to print on.
10. Select the type of paper you loaded as the **Media Type** setting.

Note: Check the paper type settings list for details.

11. Select the **Print Quality** setting you want to use.
12. Select any of the available print options.

[Paper Source Options - Mac OS X 10.5/10.6/10.7](#)

[Print Quality Options - Mac OS X 10.5/10.6/10.7](#)

[Print Options - Mac OS X 10.5/10.6/10.7](#)

Parent topic: [Printing with Mac OS X 10.5, 10.6, or 10.7](#)

Related references

[Paper or Media Type Settings](#)

Related tasks

[Selecting Page Setup Settings - Mac OS X 10.5/10.6/10.7](#)

[Printing Your Document or Photo - Mac OS X 10.5/10.6/10.7](#)

Paper Source Options - Mac OS X 10.5/10.6/10.7

You can select any of the available options in the Paper Source menu to print from paper loaded in that source.

Cassette 1

Selects the paper in cassette 1 as the paper source.

Cassette 2

Selects the paper in cassette 2 as the paper source.

Cassette 1 then 2

Selects the paper in cassette 1 as the paper source and automatically switches to cassette 2 when cassette 1 is empty.

Parent topic: [Selecting Basic Print Settings - Mac OS X 10.5/10.6/10.7](#)

Print Quality Options - Mac OS X 10.5/10.6/10.7

You can select any of the available Print Quality options to fine-tune the quality of your print. Some settings may be unavailable, depending on the paper type and border setting you have chosen.

Fast Economy

For the fastest printing with draft quality.

Economy

For fast printing with reduced quality.

Normal

For everyday text and image printing.

Fine

For text and graphics with good quality and print speed.

Quality

For photos and graphics with good quality and print speed.

High Quality

For photos and graphics with high print quality.

Best Quality

For the best print quality, but the slowest print speed.

Parent topic: [Selecting Basic Print Settings - Mac OS X 10.5/10.6/10.7](#)

Print Options - Mac OS X 10.5/10.6/10.7

You can select any of the print options to customize your print. Some options may be unavailable, depending on other settings you have chosen.

Expansion

If you selected a borderless paper size setting, adjusts the image expansion settings to control printing at the edges of borderless prints.

Grayscale

Prints text and graphics in black or shades of gray.

Mirror Image

Flips the printed image left to right.

Note: If you select the **Min** option for the Expansion setting, you may see white borders on your printed photo.

Parent topic: [Selecting Basic Print Settings - Mac OS X 10.5/10.6/10.7](#)

Selecting Page Setup Settings - Mac OS X 10.5/10.6/10.7

Depending on your application, you may be able to select the paper size and orientation settings from the print window.

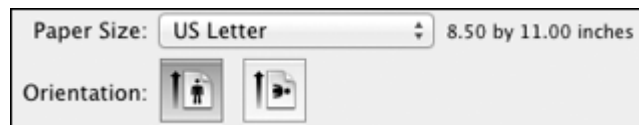

Note: If you do not see these settings in the print window, check for them in your application before printing. They may be accessible by selecting **Page Setup** from the File menu.

1. Select the size of the paper you loaded as the **Paper Size** setting. If you are printing a borderless photo, select a paper size with a **Borderless** option. You can also select a custom setting to create a custom paper size (custom paper sizes are only available for Cassette 1).

Note: You must select a compatible borderless paper type and size to print borderlessly. Check the borderless paper compatibility list for details.

2. Select the orientation of your document or photo as shown in the print window.

Note: If you are printing an envelope, select the  icon.

Note: You can reduce or enlarge the size of the printed image by selecting **Paper Handling** from the pop-up menu and selecting a scaling option.

Parent topic: [Printing with Mac OS X 10.5, 10.6, or 10.7](#)

Selecting Print Layout Options - Mac OS X 10.5/10.6/10.7

You can select a variety of layout options for your document or photo by selecting **Layout** from the pop-up menu on the print window.

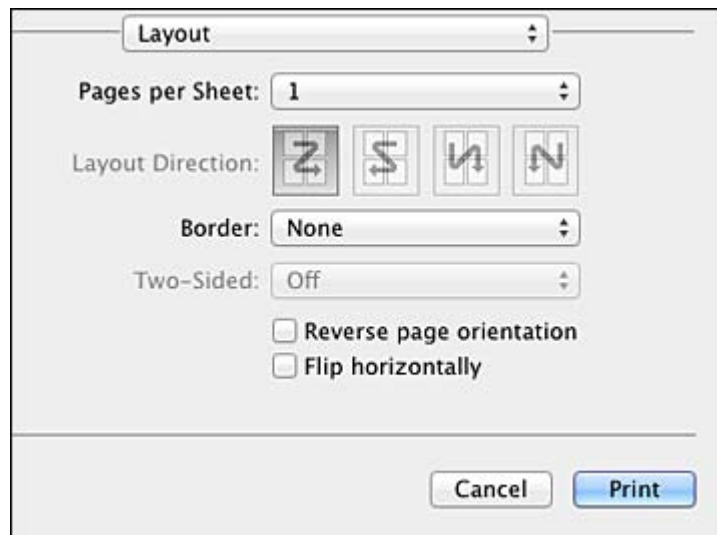

- To print multiple pages on one sheet of paper, select the number of pages in the **Pages per Sheet** pop-up menu. To arrange the print order of the pages, select a **Layout Direction** setting.
- To print borders around each page on the sheet, select a line setting from the **Border** pop-up menu.
- To invert or flip the printed image, select the **Reverse page orientation** or **Flip horizontally** settings.

Parent topic: [Printing with Mac OS X 10.5, 10.6, or 10.7](#)

Selecting Double-sided Printing Settings - Mac OS X 10.5/10.6/10.7

You can print on both sides of the paper by selecting **Two-sided Printing Settings** or **Output Settings** from the pop-up menu on the print window.

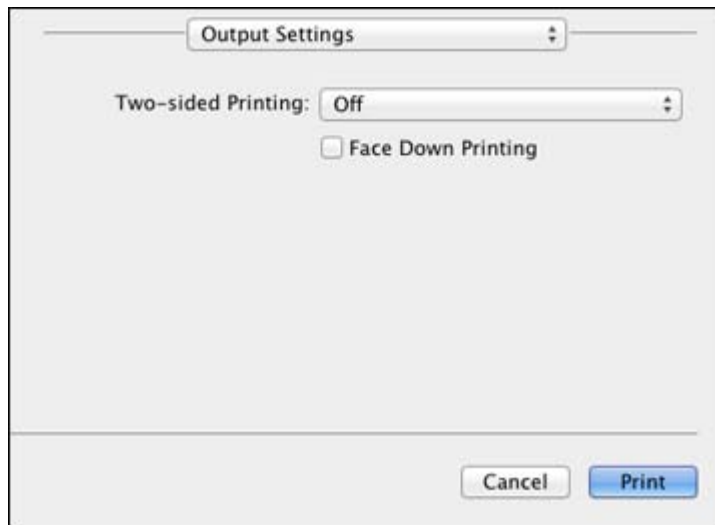

Note: Some options may be pre-selected or unavailable, depending on other settings you have chosen or if you are accessing the product over a network. This screen may be different, depending on the version of Mac OS X you are using.

1. Select one of the **Two-sided Printing** options.

2. Select the type of document you are printing as the **Document Type** setting. The software automatically sets the Adjustments options for that document type.

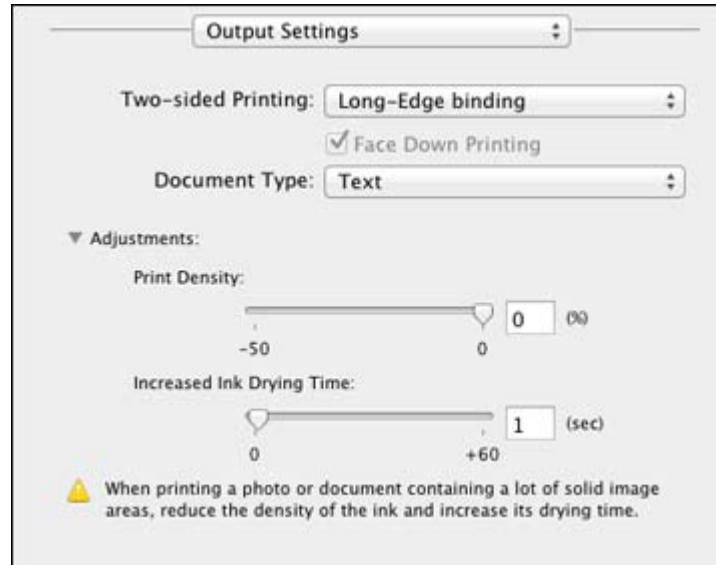

3. If necessary, customize the Adjustments settings as instructed on the screen.
4. Print a test copy of your double-sided document to test the selected settings.
5. Follow any instructions displayed on the screen during printing.

[Double-sided Printing Options and Adjustments - Mac OS X](#)

Parent topic: [Printing with Mac OS X 10.5, 10.6, or 10.7](#)

Double-sided Printing Options and Adjustments - Mac OS X

You can select any of the available options in the **Two-sided Printing Settings** or **Output Settings** pop-up menu to set up your double-sided print job.

Two-sided Printing Options

Long-Edge binding

Orients double-sided printed pages to be bound on the long edge of the paper.

Short-Edge binding

Orients double-sided printed pages to be bound on the short edge of the paper.

Adjustments

Print Density

Sets the level of ink coverage for double-sided printing.

Increased Ink Drying Time

Sets the amount of time required for drying ink after printing on one side of the paper before printing the other side in double-sided printing.

Parent topic: [Selecting Double-sided Printing Settings - Mac OS X 10.5/10.6/10.7](#)

Managing Color - Mac OS X 10.5/10.6/10.7

You can adjust the Color Matching and Color Options settings to fine-tune the colors in your printout, or turn off color management in your printer software.

1. Select **Color Matching** from the pop-up menu in the print window.



2. Select one of the available options.
3. Select **Color Options** from the pop-up menu in the print window.

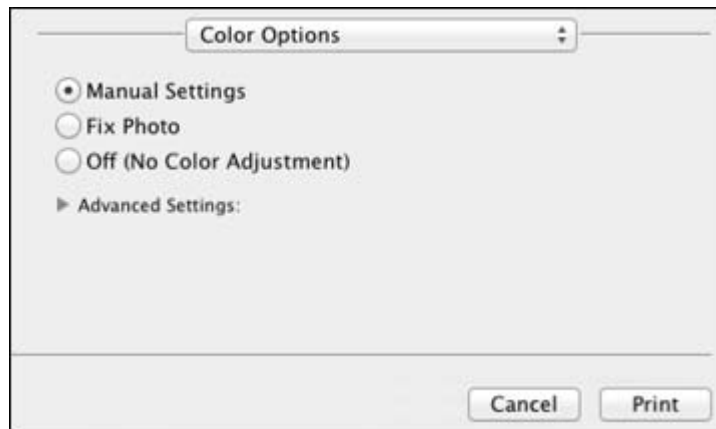

Note: The available settings on the Color Options menu depend on the option you selected on the Color Matching menu.

4. Select one of the available options.

[Color Matching and Color Options - Mac OS X 10.5/10.6/10.7](#)

Parent topic: [Printing with Mac OS X 10.5, 10.6, or 10.7](#)

Related concepts

[Print Head Cleaning](#)

Related references

[Available EPSON Papers](#)

Related tasks

[Removing and Installing Ink Cartridges](#)

Color Matching and Color Options - Mac OS X 10.5/10.6/10.7

You can select from these settings on the Color Matching and Color Options menus.

Color Matching Settings

EPSON Color Controls

Lets you manage color using controls in your printer software, or turn off color management.

ColorSync

Prints using standard color profiles for your product and paper to help match image colors. You can customize the conversion method and filter settings on the ColorSync pop-up menu in the print window.

Color Options Settings

Manual Settings

Lets you select manual color adjustments. Click the arrow next to **Advanced Settings** and select settings for **Brightness**, **Contrast**, **Saturation**, and individual color tones. You can also select a color **Mode** setting for printing photos and graphics. If you select the **Adobe RGB** color mode, you can also adjust the midtone density using the **Gamma** setting.

Fix Photo

Improves the color, contrast, and sharpness of flawed photos.

Note: Fix Photo uses a sophisticated face recognition technology to optimize photos that include faces. For this to work, both eyes and the nose must be visible in the subject's face. If your photo

includes a face with an intentional color cast, such as a statue, you may want to turn off **Fix Photo** to retain the special color effects.

Fix Red-Eye

Reduces or removes red-eye in photos.

Off (No Color Adjustment)

Turns off color management in your printer software so you can manage color using only your application software.

Parent topic: [Managing Color - Mac OS X 10.5/10.6/10.7](#)

Selecting Printing Preferences - Mac OS X 10.5/10.6/10.7

You can select printing preferences that apply to all the print jobs you send to your product.

1. In the Apple menu or the Dock, select **System Preferences**.
2. Select **Print & Fax** or **Print & Scan**, select your product, and select **Options & Supplies**.
3. Select **Driver**.

You see this screen:

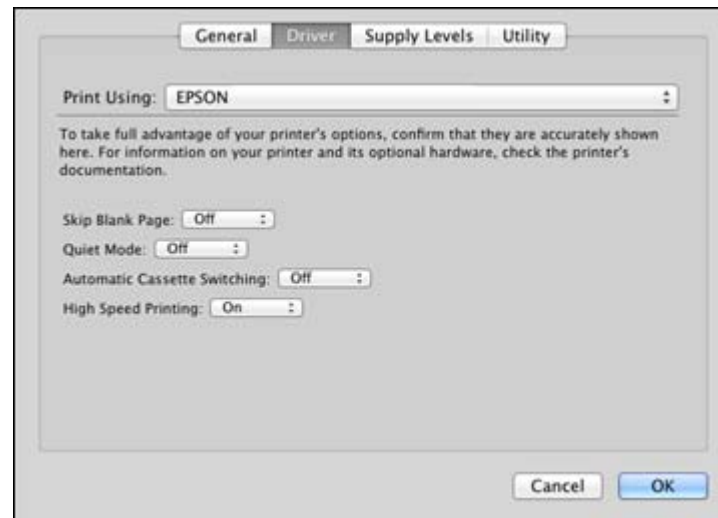

4. Select any of the available printing preferences.

5. Click **OK**.

[Printing Preferences - Mac OS X 10.5/10.6/10.7](#)

Parent topic: [Printing with Mac OS X 10.5, 10.6, or 10.7](#)

Printing Preferences - Mac OS X 10.5/10.6/10.7

You can select from these settings on the Driver tab.

Skip Blank Page

Ensures that your product does not print pages that contain no text or images.

Quiet Mode

Lessens noise during printing when you select **Plain Paper/Bright White Paper** as the paper Type or Media Type setting.

Automatic Cassette Switching

Automatically switches to the other cassette when one of the cassettes runs out of paper.

High Speed Printing

Speeds up printing, but may reduce print quality.

Parent topic: [Selecting Printing Preferences - Mac OS X 10.5/10.6/10.7](#)

Printing Your Document or Photo - Mac OS X 10.5/10.6/10.7

Once you have selected your print settings, you are ready to print.

Click **Print** at the bottom of the print window.

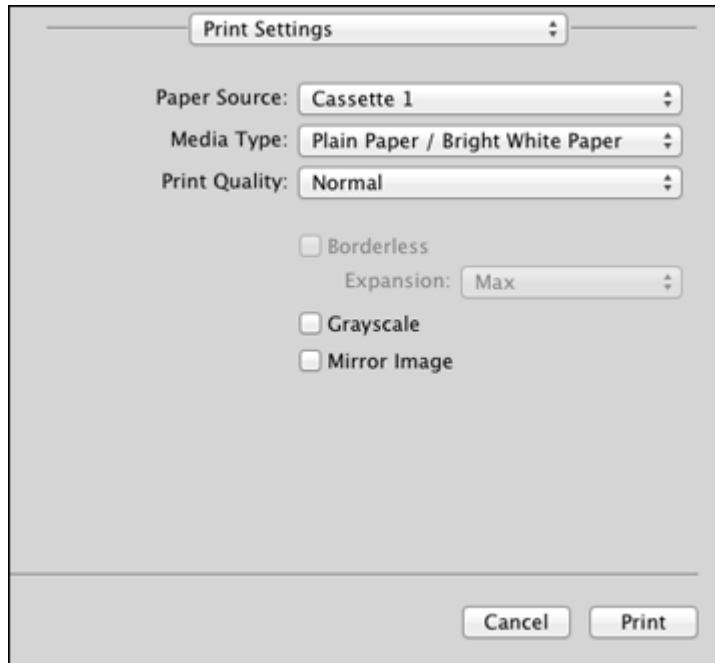

[Checking Print Status - Mac OS X 10.5/10.6/10.7](#)

Parent topic: [Printing with Mac OS X 10.5, 10.6, or 10.7](#)

Checking Print Status - Mac OS X 10.5/10.6/10.7

During printing, you can view the progress of your print job, control printing, and check ink cartridge status.

1. Click the printer icon when it appears in the Dock.

You see the print status window:

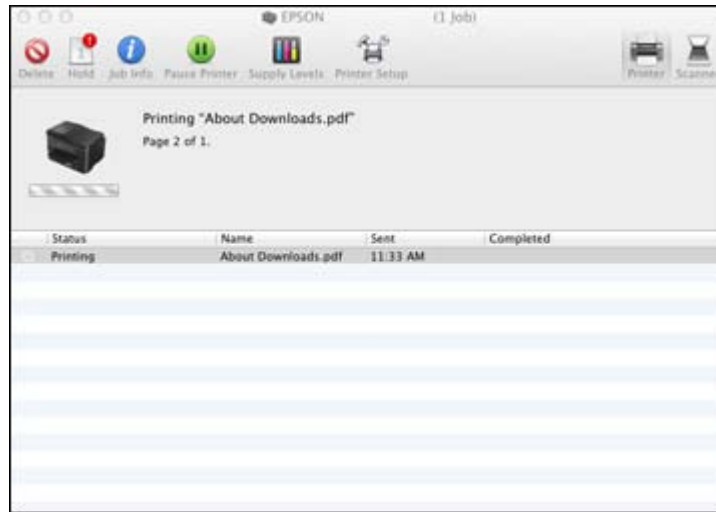

2. Select the following options as necessary:

- To cancel printing, click the print job and click **Delete**.
- To pause a print job, click the print job and click **Hold**. To resume a print job, click the print job marked "Hold" and click **Resume**.
- To pause printing for all queued print jobs, click **Pause Printer**.
- To check ink status, click **Supply Levels**.

Parent topic: [Printing Your Document or Photo - Mac OS X 10.5/10.6/10.7](#)

Printing with Mac OS X 10.4

You can print with your product using any Mac OS X printing program, as described in these sections.

[Selecting Page Setup Settings - Mac OS X 10.4](#)

[Selecting Basic Print Settings - Mac OS X 10.4](#)

[Selecting Print Layout Options - Mac OS X 10.4](#)

[Selecting Double-sided Printing Settings - Mac OS X 10.4](#)

[Managing Color - Mac OS X 10.4](#)

[Selecting Printing Preferences - Mac OS X 10.4](#)

[Printing Your Document or Photo - Mac OS X 10.4](#)

Parent topic: [Printing From a Computer](#)

Selecting Page Setup Settings - Mac OS X 10.4

Select the page setup settings for the document or photo you want to print.

1. Open a photo or document for printing.
2. Select the **Page Setup** command in your application.

Note: You may need to select a print icon on your screen, the **Page Setup** option in the File menu, or another command. See your application's help utility for details.

3. Select your product as the **Format for** setting.

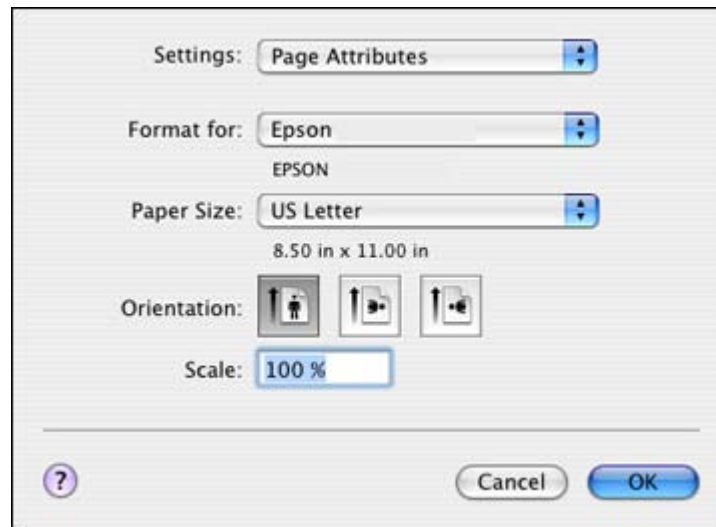

4. Select the size of the paper you loaded as the **Paper Size** setting. If you are printing a borderless photo, select a paper size with a **(Borderless)** option. You can also select a custom setting to create a custom paper size (custom paper sizes are only available for Cassette 1).

Note: You must select a compatible borderless paper type and size to print borderlessly. Check the borderless paper compatibility list for details.

5. Select the orientation of your document or photo as shown in the page setup window.

Note: If you are printing an envelope, select the  icon.

6. To reduce or enlarge the size of the printed image, select a different **Scale** setting.
7. Click **OK** to close the window.

Parent topic: [Printing with Mac OS X 10.4](#)

Selecting Basic Print Settings - Mac OS X 10.4

Select the basic settings for the document or photo you want to print.

1. Select the print command in your application.

Note: You may need to select a print icon on your screen, the **Print** option in the **File** menu, or another command. See your application's help utility for details.

2. Select your product as the **Printer** setting.

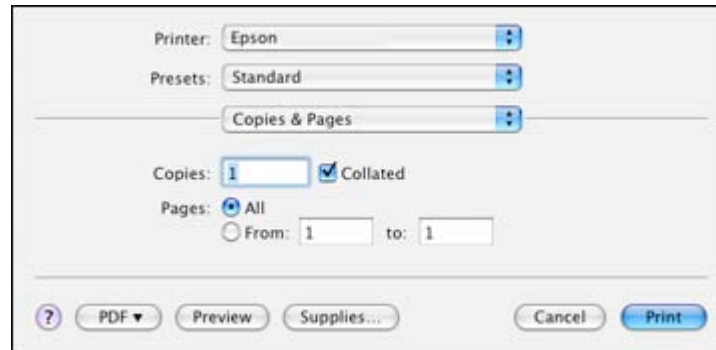

3. Select the **Copies** and **Pages** settings as necessary.

Note: If you do not see these settings in the print window, check for them in your application before printing.

4. Select **Print Settings** from the pop-up menu.



5. Select the **Paper Source** setting that indicates where you loaded the paper you want to print on.
6. Select the type of paper you loaded as the **Media Type** setting.

Note: Check the paper type settings list for details.

7. Select the **Print Quality** setting you want to use.
8. Select any of the available print options.

[Paper Source Options - Mac OS X 10.4](#)

[Print Quality Options - Mac OS X 10.4](#)

[Print Options - Mac OS X 10.4](#)

Parent topic: [Printing with Mac OS X 10.4](#)

Related references

[Paper or Media Type Settings](#)

Related tasks

[Printing Your Document or Photo - Mac OS X 10.4](#)

Paper Source Options - Mac OS X 10.4

You can select any of the available options in the Paper Source menu to print from paper loaded in that source.

Cassette 1

Selects the paper in cassette 1 as the paper source.

Cassette 2

Selects the paper in cassette 2 as the paper source.

Cassette 1 then 2

Selects the paper in cassette 1 as the paper source and automatically switches to cassette 2 when cassette 1 is empty.

Parent topic: [Selecting Basic Print Settings - Mac OS X 10.4](#)

Print Quality Options - Mac OS X 10.4

You can select any of the available Print Quality options to fine-tune the quality of your print. Some settings may be unavailable, depending on the paper type and border setting you have chosen.

Fast Economy

For the fastest printing with draft quality.

Economy

For fast printing with reduced quality.

Normal

For everyday text and image printing.

Fine

For text and graphics with good quality and print speed.

Quality

For photos and graphics with good quality and print speed.

High Quality

For photos and graphics with high print quality.

Best Quality

For the best print quality, but the slowest print speed.

Parent topic: [Selecting Basic Print Settings - Mac OS X 10.4](#)

Print Options - Mac OS X 10.4

You can select any of the print options to customize your print. Some options may be unavailable, depending on other settings you have chosen.

Expansion

If you selected a borderless paper size setting, adjusts the image expansion settings to control printing at the edges of borderless prints.

Grayscale

Prints text and graphics in black or shades of gray.

Mirror Image

Lets you flip the printed image horizontally.

Note: If you select the **Min** option for the Expansion setting, you may see white borders on your printed photo.

Parent topic: [Selecting Basic Print Settings - Mac OS X 10.4](#)

Selecting Print Layout Options - Mac OS X 10.4

You can select layout options for multi-page documents by selecting **Layout** from the pop-up menu on the print window.

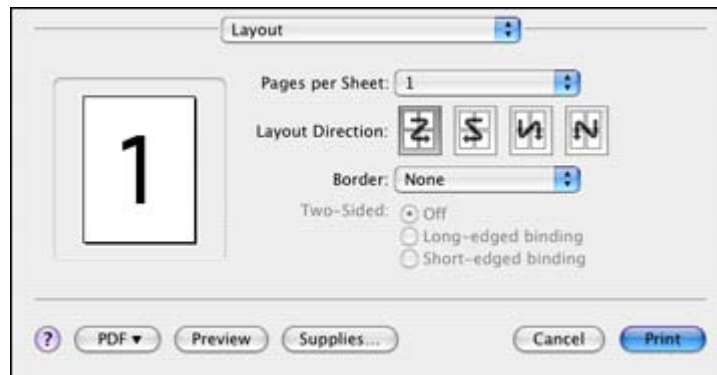

- To print multiple pages on one sheet of paper, select the number of pages in the **Pages per Sheet** pop-up menu. To arrange the print order of the pages, select a **Layout Direction** setting.
- To print borders around each page on the sheet, select a line setting from the **Border** pop-up menu.

Parent topic: [Printing with Mac OS X 10.4](#)

Selecting Double-sided Printing Settings - Mac OS X 10.4

You can print on both sides of the paper by selecting **Two-sided Printing Settings** from the pop-up menu on the print window.

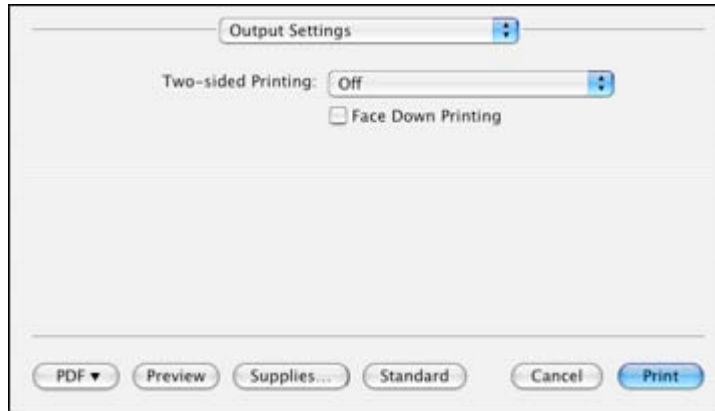

Note: Some options may be pre-selected or unavailable, depending on other settings you have chosen or if you are accessing the product over a network.

1. Select one of the **Two-sided Printing** options.

2. Select the type of document you are printing as the **Document Type** setting. The software automatically sets the Adjustments options for that document type.

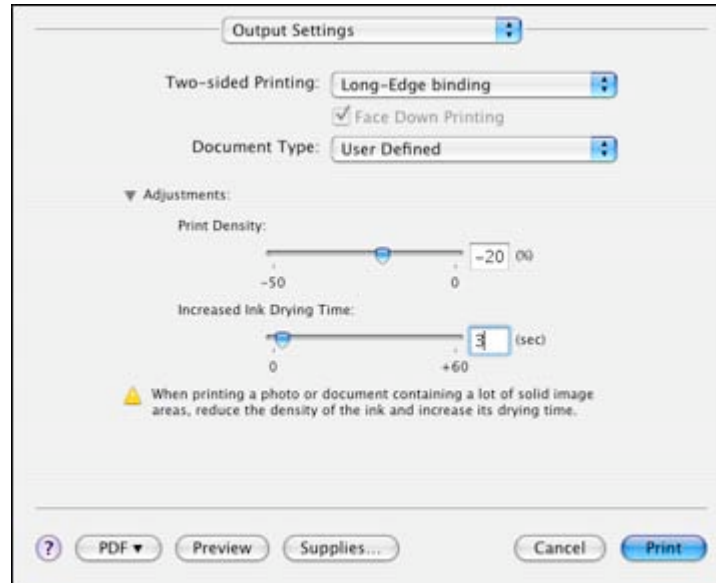

3. If necessary, customize the Adjustments settings as instructed on the screen.
4. Print a test copy of your double-sided document to test the selected settings.
5. Follow any instructions displayed on the screen during printing.

Parent topic: [Printing with Mac OS X 10.4](#)

Related references

[Double-sided Printing Options and Adjustments - Mac OS X](#)

Managing Color - Mac OS X 10.4

You can adjust the Color Options settings to fine-tune the colors in your printout, or turn off color management in your printer software.

1. Select **Color Options** from the pop-up menu in the print window.



2. Select one of the available options.

[Color Options - Mac OS X 10.4](#)

Parent topic: [Printing with Mac OS X 10.4](#)

Color Options - Mac OS X 10.4

You can select from these settings on the Color Options menu.

Manual Settings

Lets you select manual color adjustments. Click the arrow next to **Advanced Settings** and select settings for **Brightness**, **Contrast**, **Saturation**, and individual color tones. You can also select a color **Mode** setting for printing photos and graphics. If you select the **Adobe RGB** color mode, you can also adjust the midtone density using the **Gamma** setting.

ColorSync

Prints using standard color profiles for your product and paper to help match image colors. You can customize the conversion method and filter settings on the **ColorSync** pop-up menu in the print window.

Off (No Color Adjustment)

Turns off color management in your printer software so you can manage color using only your application software.

Parent topic: [Managing Color - Mac OS X 10.4](#)

Selecting Printing Preferences - Mac OS X 10.4

You can select various printing preferences from the Extension Settings menu.

1. Select **Extension Settings** from the pop-up menu in the print window.

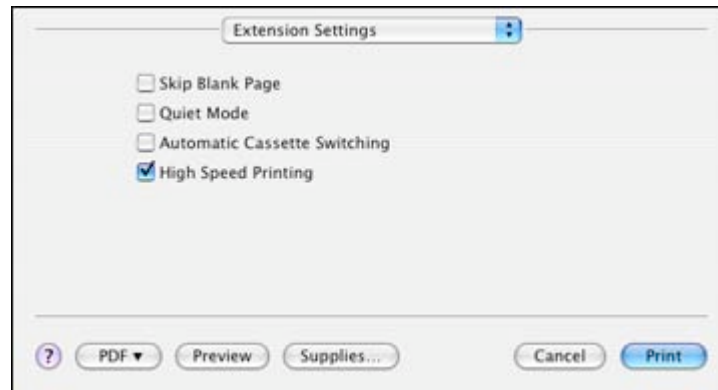

2. Select any of the available printing preferences.

[Printing Preferences - Mac OS X 10.4](#)

Parent topic: [Printing with Mac OS X 10.4](#)

Printing Preferences - Mac OS X 10.4

You can select from these options on the Extension Settings menu.

Skip Blank Page

Ensures that your product does not print pages that contain no text or images.

Quiet Mode

Lessens noise during printing when you select **Plain Paper/Bright White Paper** as the paper Type or Media Type setting.

Automatic Cassette Switching

Automatically switches to the other cassette when one of the cassettes runs out of paper.

High Speed Printing

Speeds up printing, but may reduce print quality.

Parent topic: [Selecting Printing Preferences - Mac OS X 10.4](#)

Printing Your Document or Photo - Mac OS X 10.4

Once you have selected your print settings, you are ready to print.

Click **Print** at the bottom of the print window.



[Checking Print Status - Mac OS X 10.4](#)

Parent topic: [Printing with Mac OS X 10.4](#)

Checking Print Status - Mac OS X 10.4

During printing, you can view the progress of your print job, control printing, and check ink cartridge status.

1. Click the printer icon when it appears in the Dock.

You see the print status window:

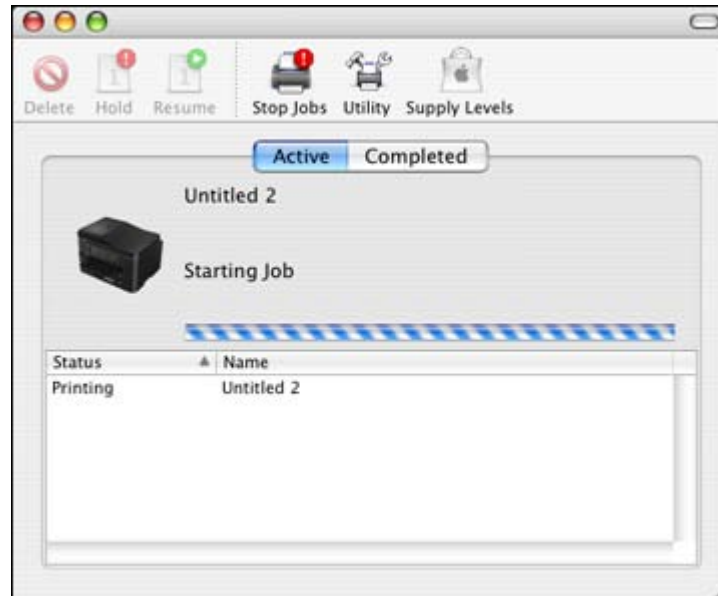

2. Select the following options as necessary:

- To cancel printing, click the print job and click **Delete**.
- To pause printing, click the print job and click **Hold**. To resume printing, click the print job marked "Hold" and click **Resume**.
- To check ink status, click **Supply Levels**.

Parent topic: [Printing Your Document or Photo - Mac OS X 10.4](#)

Cancelling Printing Using a Product Button

If you need to cancel printing, select **Cancel** on your product.

Parent topic: [Printing From a Computer](#)

Scanning

You can scan original documents or photos and save them as digital files on your computer.

[Starting a Scan](#)

[Selecting EPSON Scan Settings](#)

[Scanning with Mac OS X 10.6/10.7 Using Image Capture](#)

[Scanning Special Projects](#)

Starting a Scan

After placing your original documents or photos in your product for scanning, start scanning using one of these methods.

[Starting a Scan Using the Product Control Panel](#)

[Starting a Scan Using the EPSON Scan Icon](#)

[Starting a Scan from a Scanning Program](#)

Parent topic: [Scanning](#)

Starting a Scan Using the Product Control Panel

You can scan an image to your computer using your product's control panel buttons.

Your product automatically selects suitable default scan settings, but you can view or change them as necessary.

1. Make sure you installed the product software and connected the product to your computer or network.

Note: With Mac OS X 10.6/10.7, you must connect your product with a USB cable to scan using the buttons.

2. Press the  home button, if necessary
3. Select **Scan**.

The scan options are displayed:



4. Select a scan option.
 - **Scan to Memory Card** saves your scan file on a memory card and lets you select the file format, quality, and other settings.
 - **Scan to PC** saves your scan as a JPEG file to your computer or as an image capture in Mac OS X 10.6/10.7.
 - **Scan to PC (PDF)** saves your scan as a PDF file to your computer or as an image capture in Mac OS X 10.6/10.7.
 - **Scan to PC (Email)** scans your original and attaches it to a message in your e-mail program. You can select the e-mail program you want to use and resize your image, if necessary, from an option screen on your computer.

Note: This works with MAPI-type email such as Microsoft Outlook, Windows Live Mail, Mac Mail, and Entourage, but not web-based email such as Gmail.
5. To scan to your computer, you first need to select how you connected your product to your computer:
 - If your product is connected directly to your computer with a USB cable, select **USB Connection** to start scanning.
 - If your product is connected to your computer over a network, select the computer name from the list to start scanning.

[Scan to Memory Card Options](#)

[Changing Default Scan Button Settings](#)

Parent topic: [Starting a Scan](#)

Scan to Memory Card Options

Select the **Scan to Memory Card** options you want to use.

Scan to Memory Card setting	Available options	Description
Format	JPEG	Select for photos
	PDF	Select for documents
2-sided	Off	Lets you scan 2-sided originals placed in the ADF
	On	
Scan Area	Letter	Select the page size for documents
	Legal	
	A4	
	Auto Cropping	Select for photos with dark edges
	Max Area	Select for most photos
Document	Text	Select the type of original you are scanning
	Photograph	
Quality	Standard	Select for documents
	Best	Select for photos

Parent topic: [Starting a Scan Using the Product Control Panel](#)

Changing Default Scan Button Settings

You can view or change the default scan settings your product uses when you scan using the product buttons. You do this using the Event Manager program.

Note: You cannot change default scan button settings with Mac OS X 10.6/10.7.

1. Do one of the following to open Event Manager:

- **Windows:** Click  or **Start > All Programs** or **Programs > EPSON Software > Event Manager**.

- **Mac OS X 10.4/10.5:** Open the **Applications** folder, click **Epson Software**, and click **Event Manager**.
2. Open the **Scanner** (Windows) or **Select Scanner** (Mac OS X) drop-down list and select your product, if necessary.
 3. Click **Make Job Settings**.
 4. Open the **Edit Job Settings** drop-down list and select the scan button settings you want to view or change.
 5. Change the settings as necessary.
 6. Click **OK**.

Parent topic: [Starting a Scan Using the Product Control Panel](#)

Starting a Scan Using the EPSON Scan Icon

You can start the EPSON Scan program to select scan settings, scan, and save the scanned image to a file.

- **Windows:** Double-click the **EPSON Scan** icon on your computer desktop.
- **Mac OS X:** Open the **Applications** folder, open the **Epson Software** folder, and double-click the **EPSON Scan** icon.

Note: With Mac OS X 10.6 or 10.7, in addition to scanning with Image Capture, you can download and install EPSON Scan scanning software. EPSON Scan provides additional image adjustment and photo correction features for enhancing scanned images, and provides an interface for TWAIN-compliant OCR scanning software, such as ABBYY FineReader. To download EPSON Scan, visit Epson's driver download site ([U.S. downloads](#) or [Canadian downloads](#)).

You see an EPSON Scan window like this:

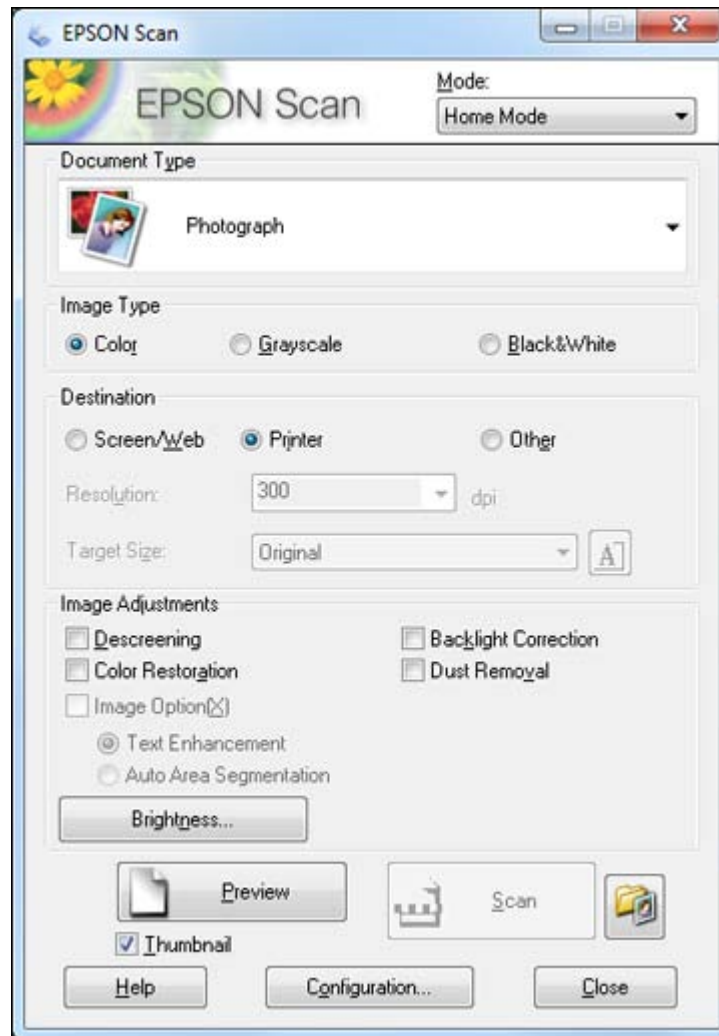

Parent topic: [Starting a Scan](#)

Related tasks

[Scanning with Mac OS X 10.6/10.7 Using Image Capture](#)

Related topics

[Selecting EPSON Scan Settings](#)

Starting a Scan from a Scanning Program

You can start EPSON Scan from a scanning program to select scan settings, scan, and open the scanned image in the program.

Note: With Mac OS X 10.6 or 10.7, in addition to scanning with Image Capture, you can download and install EPSON Scan scanning software. EPSON Scan provides additional image adjustment and photo correction features for enhancing scanned images, and provides an interface for TWAIN-compliant OCR scanning software, such as ABBYY FineReader. To download EPSON Scan, visit Epson's driver download site ([U.S. downloads](#) or [Canadian downloads](#)).

1. Open your scanning program and select its scanning option. (See your scanning program help for instructions.)
2. Select your product.

Note: In certain programs, you may need to select your product as the "source" first. If you see a **Select Source** option, choose it and select your product. With Windows, do not select a **WIA** option for your product; it will not work correctly.

You see an EPSON Scan window like this:

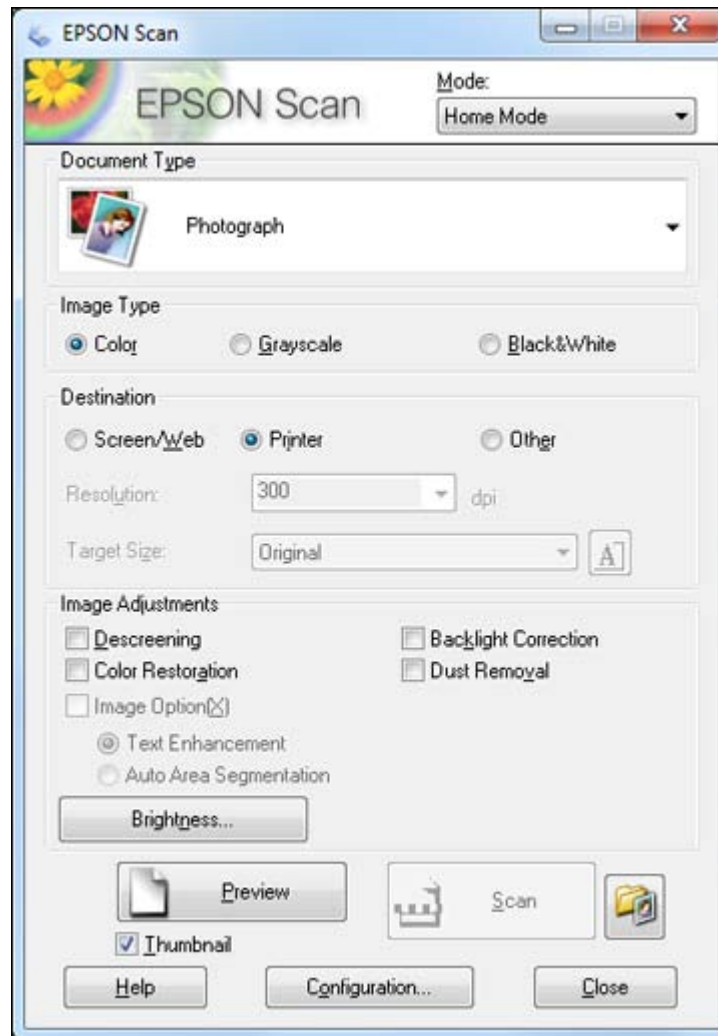

Parent topic: [Starting a Scan](#)

Related tasks

[Scanning with Mac OS X 10.6/10.7 Using Image Capture](#)

Related topics

[Selecting EPSON Scan Settings](#)

Selecting EPSON Scan Settings

After starting EPSON Scan, you can select settings in various modes to customize your scan.

[Scan Modes](#)

[Selecting the Scan Mode](#)

[Scanning in Home Mode](#)

[Scanning in Office Mode](#)

[Scanning in Professional Mode](#)

[Image Preview Guidelines](#)

[Scan Resolution Guidelines](#)

[Selecting Scan File Settings](#)

Parent topic: [Scanning](#)

Scan Modes

EPSON Scan provides a choice of scan modes with different levels of control over your settings.

Office Mode

You can quickly scan text documents and adjust them on a preview screen. You can also select various image adjustment options and preview your scanned image.

Home Mode

You can select setting groups based on the type of content you are scanning. You can also select various image adjustment options, and preview and size your scanned image.

Professional Mode

You can manually customize all available settings, and preview and size your scanned image.

Note: You have to place your original on the scanner glass when using **Home** mode.

Parent topic: [Selecting EPSON Scan Settings](#)

Related tasks

[Selecting the Scan Mode](#)

Selecting the Scan Mode

Select the EPSON Scan mode you want to use from the Mode box in the upper right corner of the EPSON Scan window:

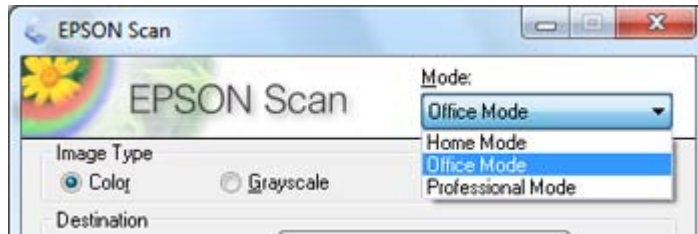

Parent topic: [Selecting EPSON Scan Settings](#)

Related tasks

[Scanning in Home Mode](#)

[Scanning in Office Mode](#)

[Scanning in Professional Mode](#)

Scanning in Home Mode

When you scan in Home Mode, EPSON Scan automatically saves your scanned file in JPEG format in your operating system's Pictures or My Pictures folder, or opens it in your scanning program. You can select settings, preview, and change the scanned file settings as necessary.

Note: You must place your original on the scanner glass when using **Home** mode.

1. Start EPSON Scan and select **Home Mode** as the Mode setting.

You see this window:

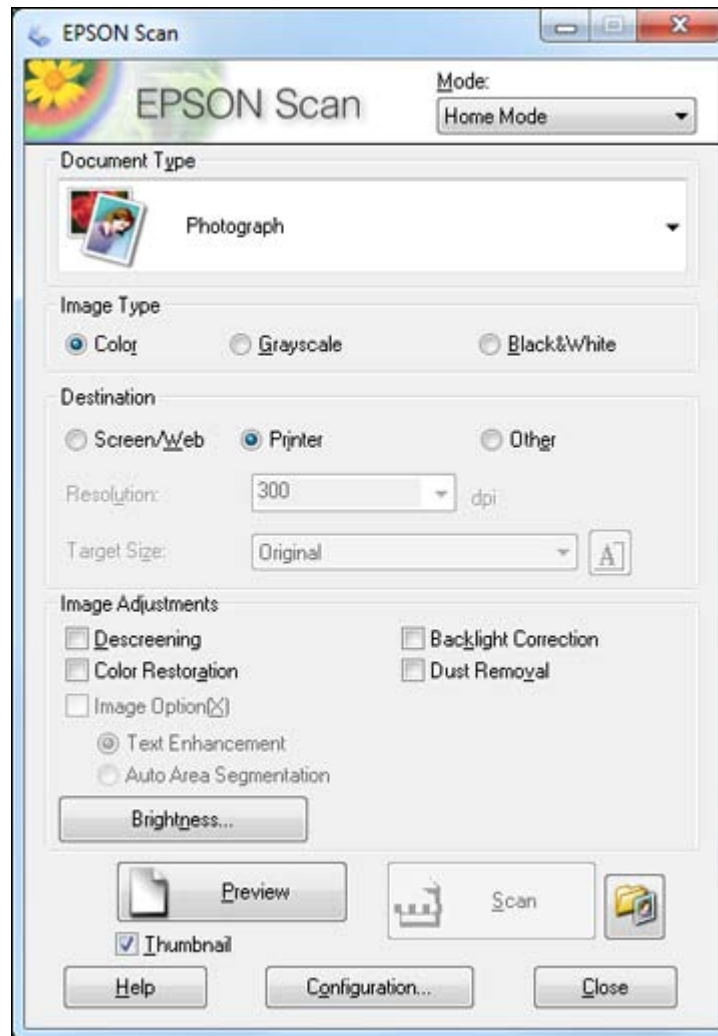

2. Select the **Document Type** setting that matches your original, such as **Photograph** or **Text/Line Art**.
3. Select the **Image Type** setting that matches your original.

4. Select the way you plan to use your scanned image as the **Destination** setting. (The Resolution setting is selected automatically based on the Destination setting you choose.)
 - **Screen/Web**: Select this option for images you will e-mail, view on a computer screen, or post on the web.
 - **Printer**: Select this option for images you will print or documents you will convert to editable text using OCR (Optical Character Recognition) software.
 - **Other**: Select this option if you want to select a custom resolution for your image.
5. If you selected **Other** in the last step, select the **Resolution** setting you want to use for your scan.
6. Click the **Preview** button.

EPSON Scan previews your original and displays the result in a separate Preview window.
7. If desired, select the area in your preview image that you want to scan (scan area).
8. Select any of the image adjustment settings you want to use. Before making adjustments, click the image or scan area in the Preview window.
9. If you want to reduce or enlarge your image as you scan, select the **Target Size** setting you want to use.
10. Click **Scan**.

You see the File Save Settings window.
11. Change any of the necessary file save settings and click **OK**.

EPSON Scan scans your original, and saves the file in the selected folder or opens it in your scanning program. If the file was saved directly to your computer, you see the file in the Windows Explorer or Mac OS X Finder, where you can view and print the image, if desired.

[Selecting a Scan Area - Home Mode](#)

[Available Image Adjustments - Home Mode](#)

[Selecting a Scan Size - Home Mode](#)

Parent topic: [Selecting EPSON Scan Settings](#)

Related concepts

[Scan Resolution Guidelines](#)

[Image Preview Guidelines](#)

Related tasks

[Selecting Scan File Settings](#)

Selecting a Scan Area - Home Mode

You can select a specific area in your preview image to include in your scanned image. You can select the entire image area or a portion of it. You can even select multiple scan areas to create multiple scanned images of different areas (Normal Preview mode only).

You can also use the scan area to select specific Image Adjustments settings for a scanned image. Just be sure to click inside the scan area before selecting the settings.

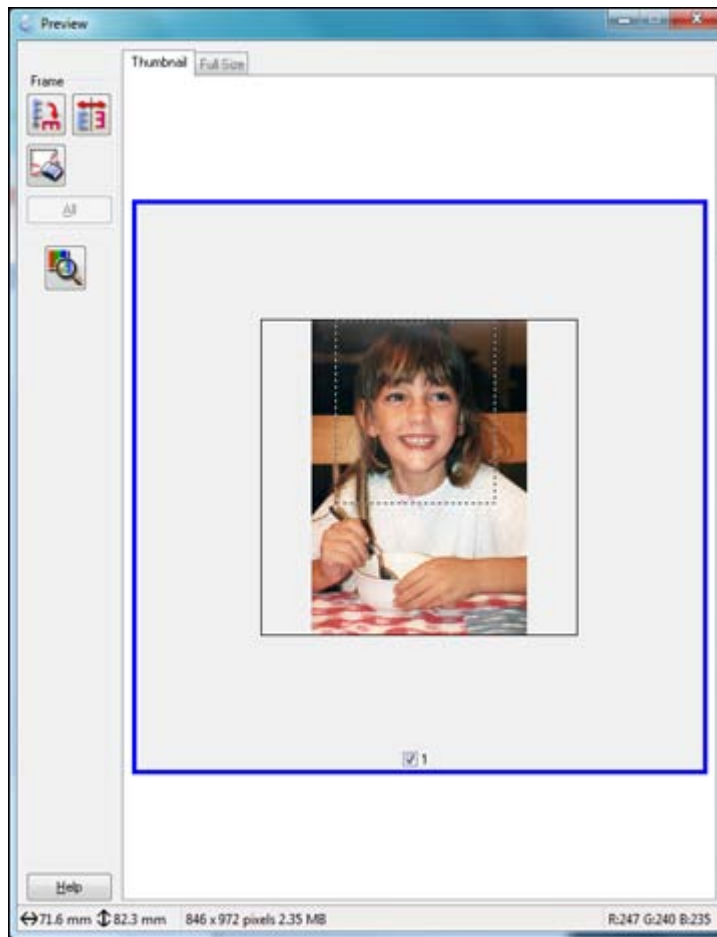

1. Do one of the following to select your scan area in the Preview image:
 - **Thumbnail preview:** Your scan area is selected automatically, but you can change it. Place your cursor in one corner of the desired scan area, then click and drag the cursor to the opposite corner to create a marquee (dotted line) on the preview image.

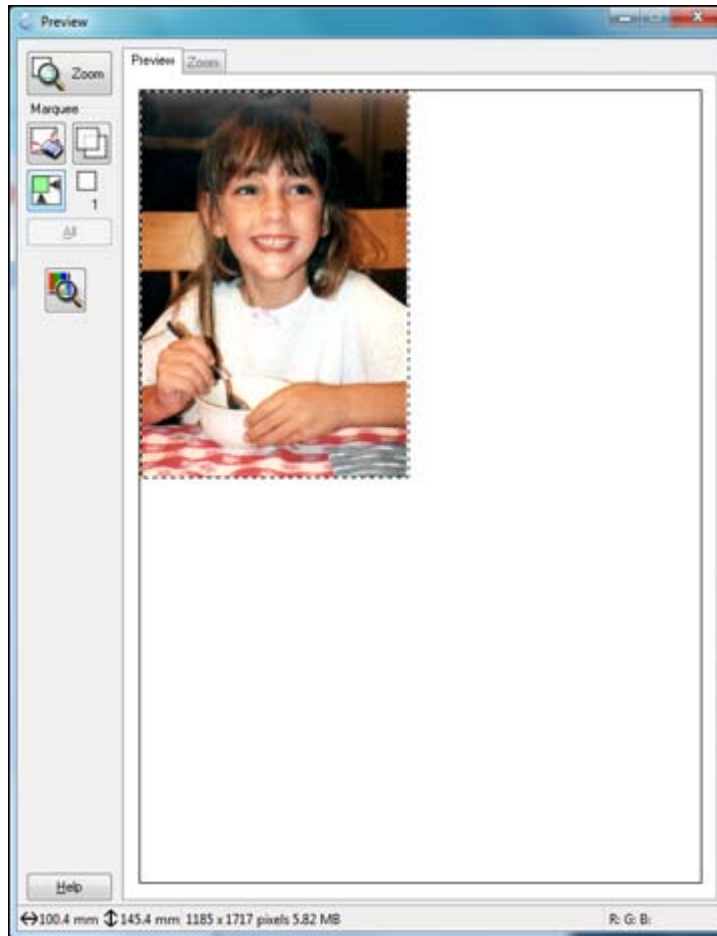

- **Normal preview:** Click the  Auto Locate icon to create a marquee (dotted line) on the preview image.



2. Do the following, as necessary, to work with the selected scan area:
 - If the marquee is correct, continue with the next step.
 - To move the marquee, click inside the scan area and drag the marquee where you want it.
 - To resize the scan area, place your cursor over the edge or corner of the marquee, then click and drag the edges where you want them. (Hold down the **Shift** key as you resize the marquee to retain the same width/height proportions.)

- **Normal preview:** To create additional marquees (up to 50), click the  Copy Marquee icon to copy the existing marquee and paste it on the preview image.
 - To delete a marquee, click the marquee, then click the  Delete Marquee icon.
3. Click inside the scan area and make any necessary settings in the EPSON Scan window.

Parent topic: [Scanning in Home Mode](#)

Available Image Adjustments - Home Mode

You can select these Image Adjustments options in EPSON Scan Home Mode.

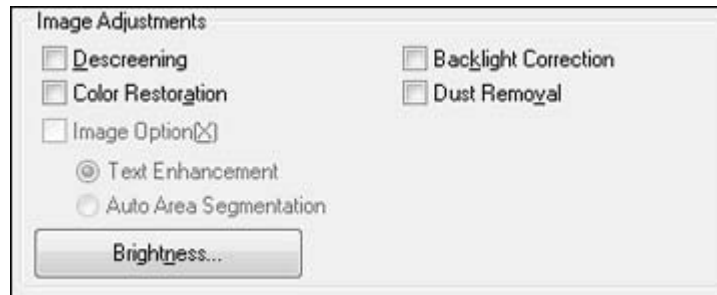

Note: Select the **Image Option** checkbox if you need to set any of the grayed-out image adjustments. Not all adjustment settings may be available, depending on the Document Type and Image Type setting. Click the **Brightness** button to access additional settings.

Descreening

Removes the ripple pattern that might appear in subtly shaded image areas, such as skin tones. This option improves results when scanning magazines or newspapers. (The results of descreening do not appear in the preview image, only in your scanned image.)

Color Restoration

Restores the colors in faded photos automatically.

Backlight Correction

Removes shadows from photos that have too much background light.

Dust Removal

Removes dust marks from your originals automatically.

Text Enhancement

Sharpens the appearance of letters in text documents.

Auto Area Segmentation

Makes grayscale images clearer and text recognition more accurate by separating the text from the graphics.

Brightness

Adjusts the overall lightness and darkness of the scanned image.

Contrast

Adjusts the difference between the light and dark areas of the overall scanned image.

Threshold

Adjusts the level at which black areas in text and line art are delineated, improving text recognition in OCR (Optical Character Recognition) programs.

Parent topic: [Scanning in Home Mode](#)

Selecting a Scan Size - Home Mode

You can reduce or enlarge the size of your image as you scan. You can also select a specific scan size, such as a common photo size like 4 × 6 inches (102 × 152 mm). This places a scan area of that size on the preview image so you can use it to help crop the image in the correct proportions.

1. Click the **Preview** button to preview your image.
2. In the EPSON Scan window, select the size you want your scanned image to be from the **Target Size** list.



Note: If you need to rotate the orientation of the target size for your image, click the  Orientation icon.

A marquee (dotted line) appears on your preview image proportioned for the size you selected.

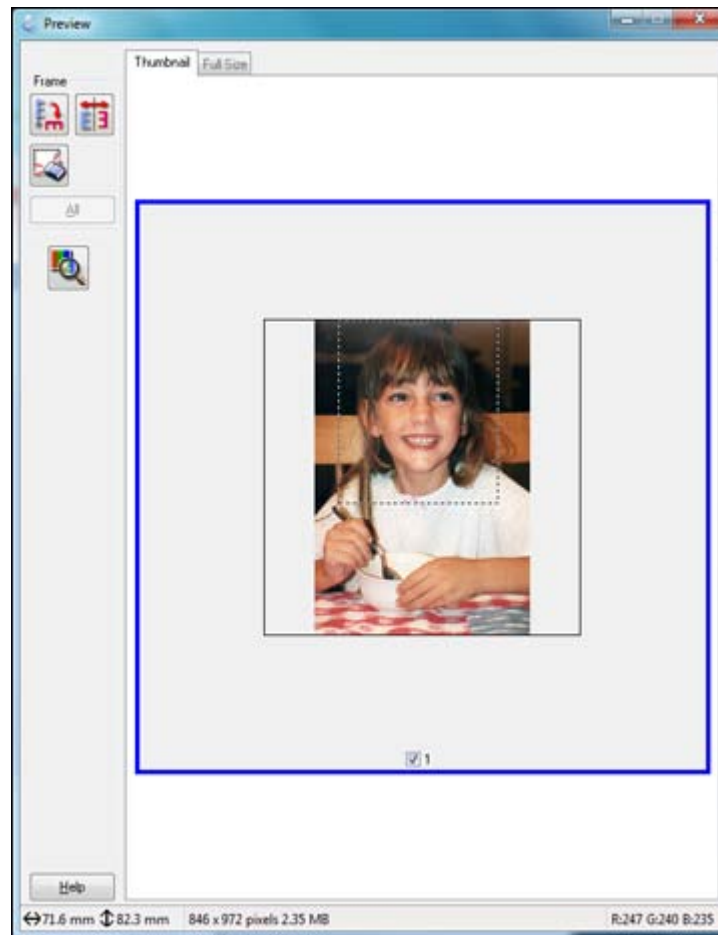

3. Do the following, as necessary, to work with the selected scan area:
 - To move the marquee, click inside the scan area and drag the marquee where you want it.
 - To resize the scan area, place your cursor over the edge or corner of the marquee, then click and drag the edge where you want it.

4. To create a scanned image size that is not available in the Target Size list, click the **Customize** option.

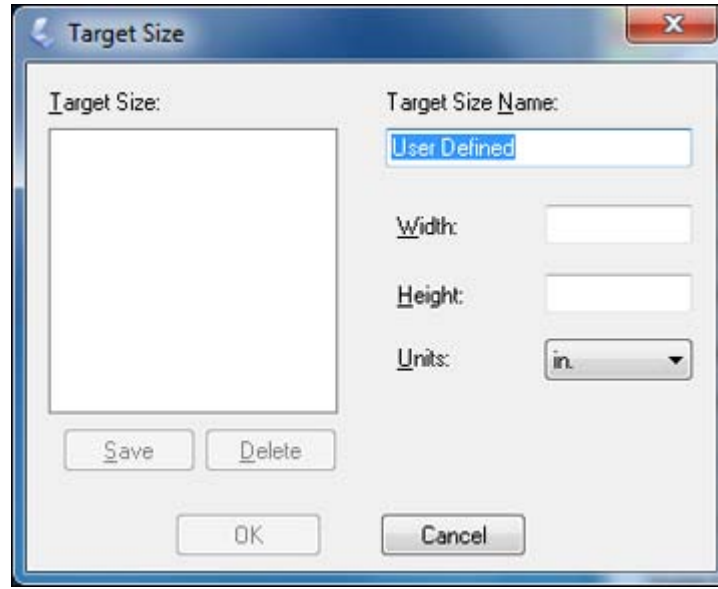

5. Name the custom size, enter the size, click **Save**, and click **OK**. Then create a scan area on the preview image.

The marquee is automatically proportioned for your custom scan size.

Parent topic: [Scanning in Home Mode](#)

Scanning in Office Mode

When you scan in Office Mode, EPSON Scan automatically saves your scanned file in JPEG format in your operating system's Pictures or My Pictures folder, or opens it in your scanning program. You can select settings, preview, and change the scanned file settings as necessary.

1. Start EPSON Scan and select **Office Mode** as the Mode setting.

You see this window:

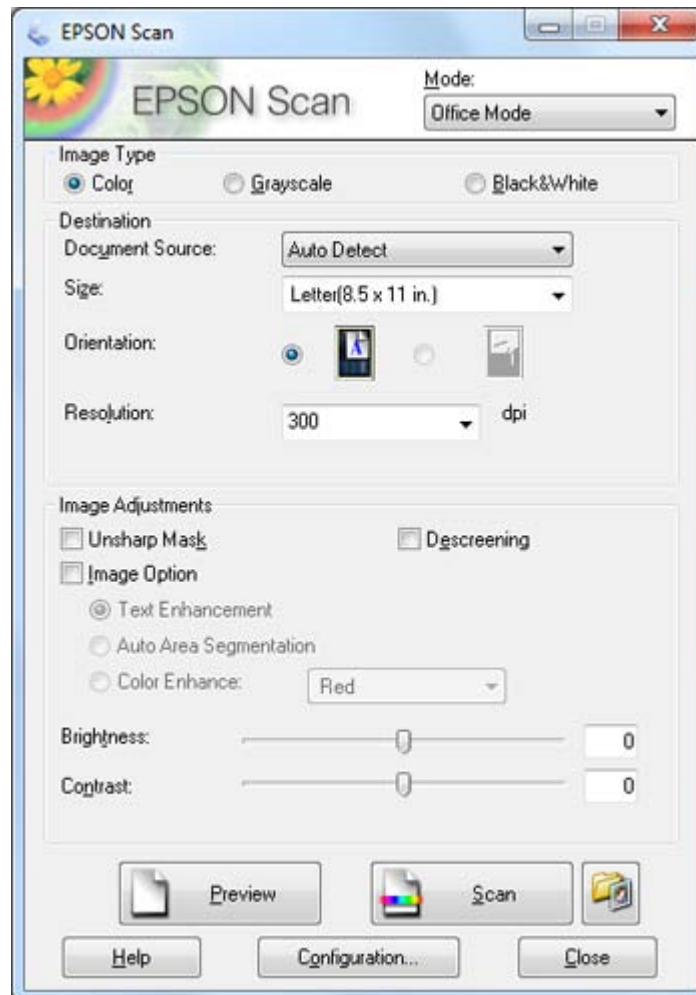

2. Select the **Image Type** setting that matches your original.
3. Select the **Document Source** setting indicating where you placed your original. To scan a 2-sided document in the ADF, select **ADF-Double-sided**.
4. Select the **Size** and **Orientation** settings that match your original.
5. Select the **Resolution** setting you want to use for your scan.
6. Click the **Preview** button.

EPSON Scan previews your original and displays the result in a separate Preview window.

7. If desired, select the area in your preview image that you want to scan (scanned image area).
8. Select any of the image adjustment settings you want to use. Before making adjustments, click the image or scanned image area in the Preview window.
9. Click **Scan**.

You see the File Save Settings window.

10. Change any of the necessary file save settings and click **OK**.

EPSON Scan scans your original, and saves the file in the selected folder or opens it in your scanning program. If the file was saved directly to your computer, you see the file in the Windows Explorer or Mac OS X Finder, where you can view and print the image, if desired.

[Selecting a Scan Area - Office Mode](#)

[Available Image Adjustments - Office Mode](#)

Parent topic: [Selecting EPSON Scan Settings](#)

Related concepts

[Scan Resolution Guidelines](#)

Related tasks

[Selecting Scan File Settings](#)

Selecting a Scan Area - Office Mode



You can select a specific area in your preview image to include in your scanned image. You can select the entire image area or a portion of it. You can even select multiple scan areas to create multiple scanned images of different areas.

You can also use the scan area to select specific Image Adjustments settings for a scanned image. Just be sure to click inside the scan area before selecting the settings.

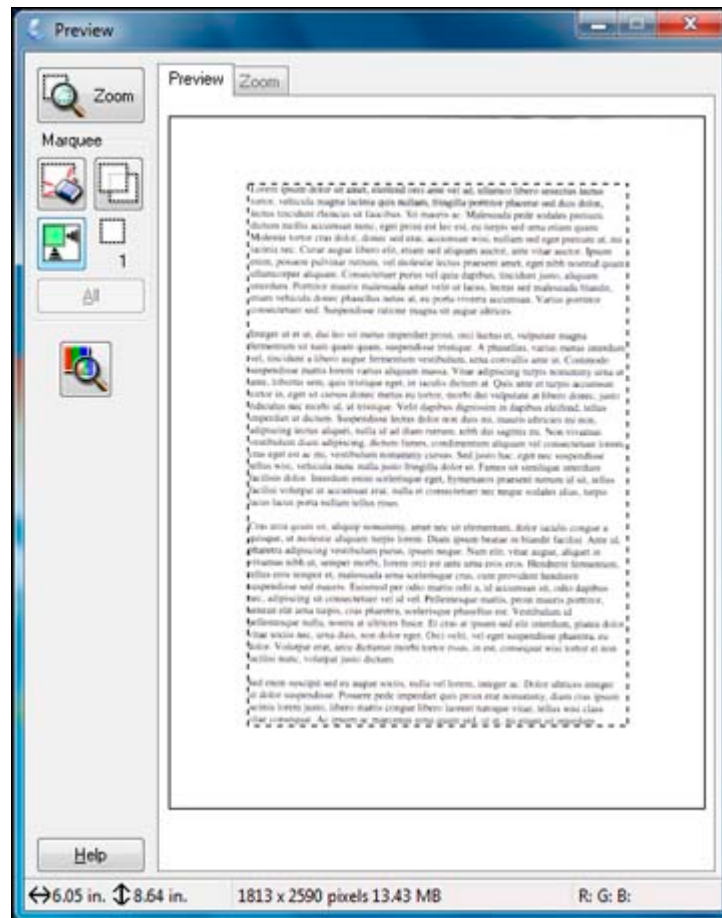
1. In the Preview window, click the  Auto Locate icon to create a marquee (dotted line) on the preview image.



2. Do the following, as necessary, to work with the selected scan area:
 - If the marquee is correct, continue with the next step.
 - To move the marquee, click inside the scan area and drag the marquee where you want it.

- To resize the scan area, place your cursor over the edge or corner of the marquee, then click and drag the edges where you want them. (Hold down the **Shift** key as you resize the marquee to retain the same width/height proportions.)
 - To create additional marquees (up to 50, if available), click the  Copy Marquee icon to copy the existing marquee and paste it on the preview image.
 - To delete a marquee, click the marquee, then click the  Delete Marquee icon.
3. Click inside each scan area and make any necessary settings in the EPSON Scan window.

Parent topic: [Scanning in Office Mode](#)

Available Image Adjustments - Office Mode

You can select these Image Adjustments options in EPSON Scan Office Mode.



Note: Select the **Image Option** checkbox if you need to set any of the grayed-out image adjustments. Not all adjustment settings may be available, depending on the Image Type setting.

Unsharp Mask

Makes the edges of certain image areas clearer. Turn off this option to leave softer edges.

Descreening

Removes the ripple pattern that might appear in subtly shaded image areas, such as skin tones. This option improves results when scanning magazines or newspapers. (The results of descreening do not appear in the preview image, only in your scanned image.)

Text Enhancement

Sharpens the appearance of letters in text documents.

Auto Area Segmentation

Makes grayscale images clearer and text recognition more accurate by separating the text from the graphics.

Color Enhance

Enhances the red, green, or blue shades in the scanned image.

Brightness

Adjusts the overall lightness and darkness of the scanned image.

Contrast

Adjusts the difference between the light and dark areas of the overall scanned image.

Threshold

Adjusts the level at which black areas in text and line art are delineated, improving text recognition in OCR (Optical Character Recognition) programs.

Parent topic: [Scanning in Office Mode](#)

Scanning in Professional Mode

When you scan in Professional Mode, EPSON Scan automatically saves your scanned file in JPEG format in your operating system's Pictures or My Pictures folder, or opens it in your scanning program. You can select settings, preview, and change the scanned file settings as necessary.

1. Start EPSON Scan and select **Professional Mode** as the Mode setting.

You see this window:

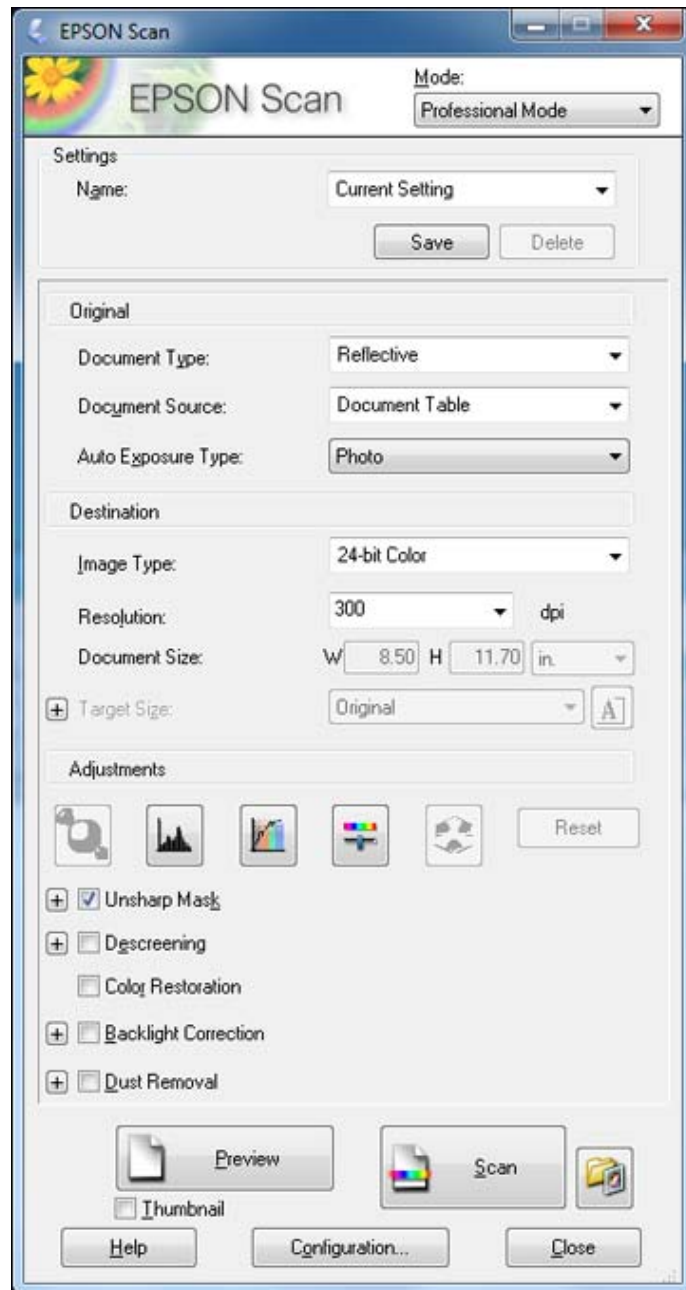

2. Select the **Document Type** setting that matches your original, such as **Reflective** for documents or photos.
3. Select the **Document Source** setting indicating where you placed your original.
4. Select the specific type of original you are scanning as the **Auto Exposure Type** setting: **Document** or **Photo**.
5. Select the details of your original and how you want it scanned as the **Image Type** setting.
6. Select the **Resolution** setting you want to use for your scan.
7. Click the **Preview** button.

EPSON Scan previews your original and displays the result in a separate Preview window.

8. If desired, select the area in your preview image that you want to scan (scan area).
9. Select any of the image adjustment settings you want to use. Before making adjustments, click the image or scanned image area in the Preview window.
10. If you want to reduce or enlarge your image as you scan, select the **Target Size** setting you want to use.
11. Click **Scan**.

You see the File Save Settings window.

12. Change any of the necessary file save settings and click **OK**.

EPSON Scan scans your original, and saves the file in the selected folder or opens it in your scanning program. If the file was saved directly to your computer, you see the file in the Windows Explorer or Mac OS X Finder, where you can view and print the image, if desired.

[Available Image Types - Professional Mode](#)

[Selecting a Scan Area - Professional Mode](#)

[Available Image Adjustments - Professional Mode](#)

[Selecting a Scan Size - Professional Mode](#)

Parent topic: [Selecting EPSON Scan Settings](#)

Related concepts

[Scan Resolution Guidelines](#)

[Image Preview Guidelines](#)

Related tasks

[Selecting Scan File Settings](#)

Available Image Types - Professional Mode

You can select these Image Type options in EPSON Scan Professional Mode.

24-bit Color

Select this setting for color photos.

Color Smoothing

Select this setting for color graphic images, such as charts or graphs.

8-bit Grayscale

Select this setting for black-and-white photos.

Black & White

Select this setting for black text documents or line art.

Parent topic: [Scanning in Professional Mode](#)

Selecting a Scan Area - Professional Mode

You can select a specific area in your preview image to include in your scanned image. You can select the entire image area or a portion of it. You can even select multiple scan areas to create multiple scanned images of different areas (Normal Preview mode only).

You can also use the scan area to select specific Image Adjustments settings for a scanned image. Just be sure to click inside the scan area before selecting the settings.

Note: In Professional Mode, the default Preview mode is Normal mode. To use Thumbnail Preview mode instead, select the **Thumbnail** checkbox beneath the Preview button (if available), then click the **Preview** button to preview your image again.

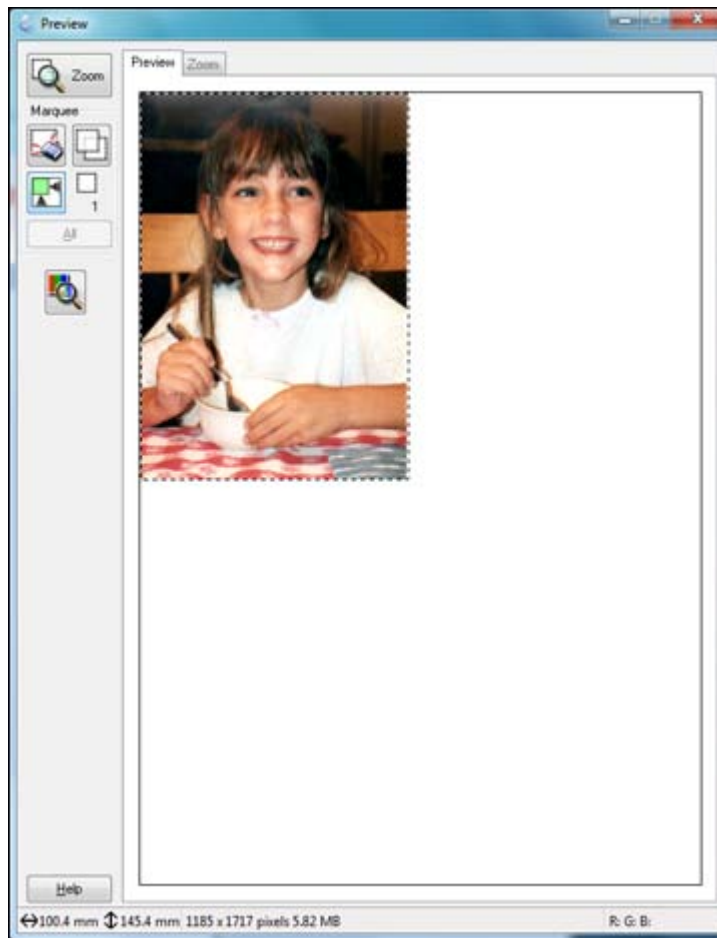

1. Do one of the following to select your scan area in the Preview image:
 - **Normal preview:** Click the  Auto Locate icon to create a marquee (dotted line) on the preview image.

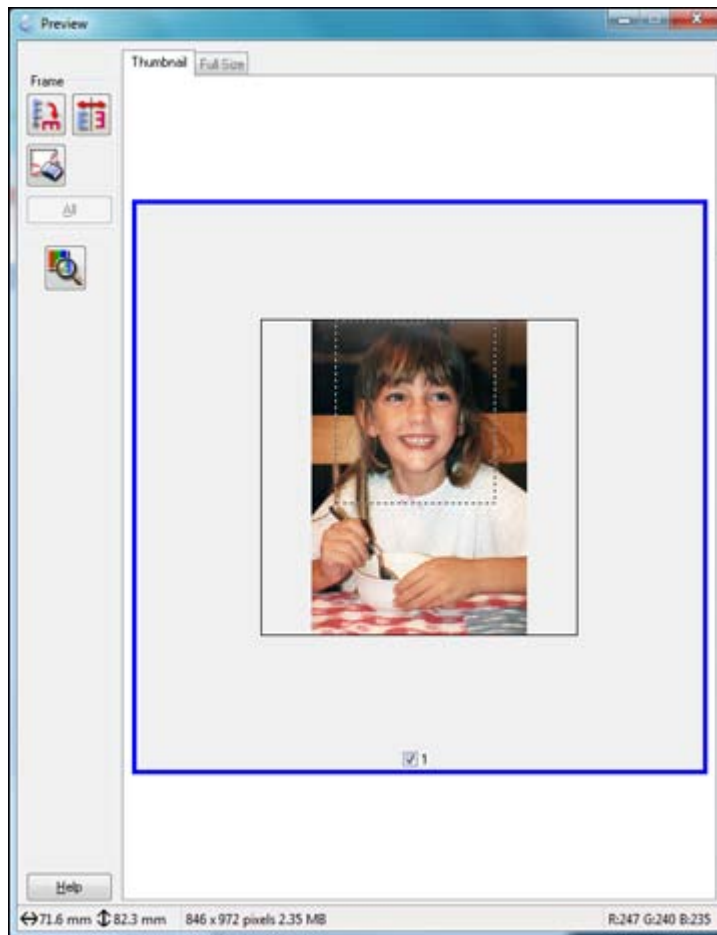

- **Thumbnail preview:** Your scan area is selected automatically, but you can change it. Place your cursor in one corner of the desired scan area, then click and drag the cursor to the opposite corner to create a marquee (dotted line) on the preview image.



2. Do the following, as necessary, to work with the selected scan area:
 - If the marquee is correct, continue with the next step.
 - To move the marquee, click inside the scan area and drag the marquee where you want it.
 - To resize the scan area, place your cursor over the edge or corner of the marquee, then click and drag the edges where you want them. (Hold down the **Shift** key as you resize the marquee to retain the same width/height proportions.)

- **Normal preview:** To create additional marquees (up to 50, if available), click the  Copy Marquee icon to copy the existing marquee and paste it on the preview image.
 - To delete a marquee, click the marquee, then click the  Delete Marquee icon.
3. Click inside the scan area and make any necessary settings in the EPSON Scan window.

Parent topic: [Scanning in Professional Mode](#)

Available Image Adjustments - Professional Mode

You can select these Adjustments options in EPSON Scan Professional Mode.

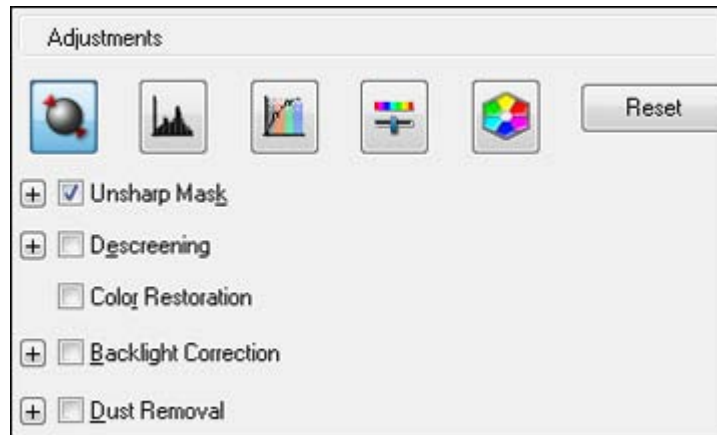

Note: Not all adjustment settings may be available, depending on the Image Type setting.

Click the  image adjustment icon to access additional settings.

Click the + (Windows) or ► (Mac OS X) icon next to a setting to change the level of adjustment.

Unsharp Mask

Makes the edges of certain image areas clearer. Turn off this option to leave softer edges.

Descreening

Removes the ripple pattern that might appear in subtly shaded image areas, such as skin tones. This option improves results when scanning magazines or newspapers. (The results of descreening do not appear in the preview image, only in your scanned image.)

Color Restoration

Restores the colors in faded photos automatically.

Backlight Correction

Removes shadows from photos that have too much background light.

Dust Removal

Removes dust marks from your originals automatically.

Auto Exposure

Automatically adjusts the image exposure settings when you click the  Auto Exposure icon. To automatically adjust image exposure settings continuously, click the **Configuration** button, click the **Color** tab, and select **Continuous auto exposure**. You can adjust the level of exposure adjustment using a slider.

Histogram Adjustment

Provides a graphical interface for adjusting highlight, shadow, and gamma levels individually. (For advanced users only.) Click the  histogram icon to access the settings.

Tone Correction

Provides a graphical interface for adjusting tone levels individually. (For advanced users only.) Click the  tone correction icon to access the settings.

Brightness

Adjusts the overall lightness and darkness of the scanned image.

Contrast

Adjusts the difference between the light and dark areas of the overall scanned image.

Saturation

Adjusts the density of colors in the overall image.

Color Balance

Adjusts the balance of colors in the overall image.

Color Palette

Provides a graphical interface for adjusting mid-tone levels, such as skin tones, without affecting the highlight and shadow areas of the image. (For advanced users only.) Click the  Color Palette icon to access the settings.

Threshold

Adjusts the level at which black areas in text and line art are delineated, improving text recognition in OCR (Optical Character Recognition) programs.

Parent topic: [Scanning in Professional Mode](#)

Selecting a Scan Size - Professional Mode

You can reduce or enlarge the size of your image as you scan. You can also select a specific scan size, such as a common photo size like 4 × 6 inches (102 × 152 mm). This places a scan area of that size on the preview image so you can use it to help crop the image in the correct proportions.

1. Click the **Preview** button to preview your image.
2. In the EPSON Scan window, select the size you want your scanned image to be from the **Target Size** list.



Note: If you need to rotate the orientation of the target size for your image, click the  orientation icon.

A marquee (dotted line) appears on your preview image proportioned for the size you selected.

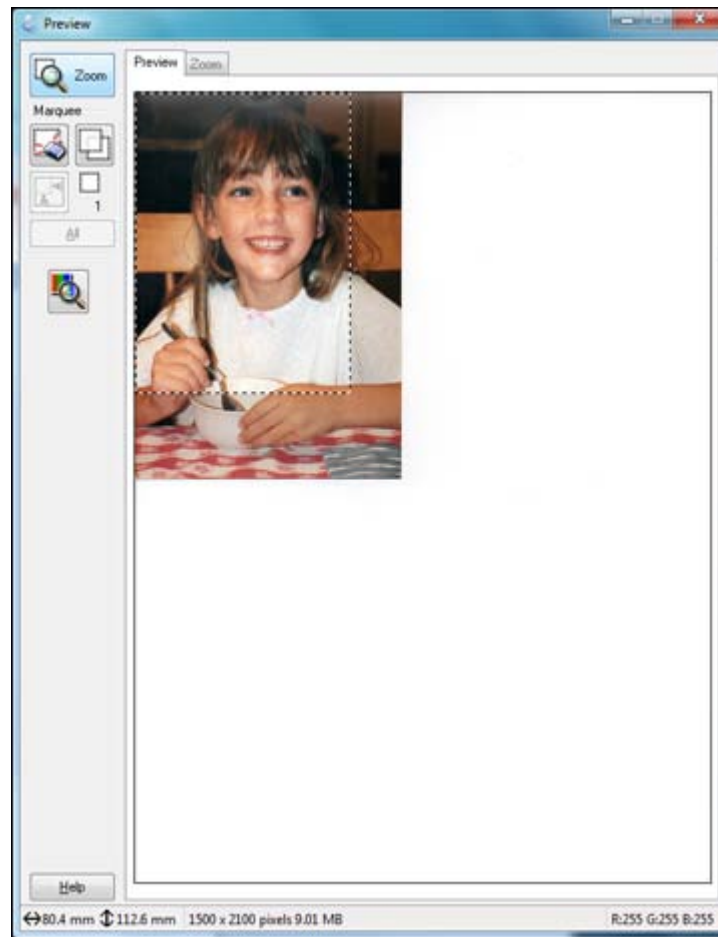

3. Do the following, as necessary, to work with the selected scan area:
 - To move the marquee, click inside the scan area and drag the marquee where you want it.
 - To resize the scan area, place your cursor over the edge or corner of the marquee, then click and drag the edge where you want it.

4. To create a scanned image size that is not available in the Target Size list, click the **Customize** option.

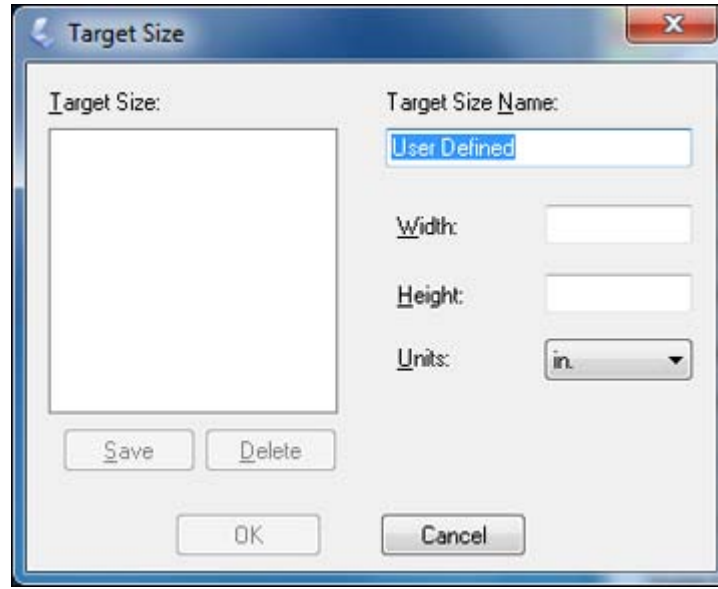

5. Name the custom size, enter the size, click **Save**, and click **OK**. Then create a scan area on the preview image.
The marquee is automatically proportioned for your custom scan size.
6. To use additional sizing tools, click the + (Windows) or ► (Mac OS X) icon next to the Target Size setting and select options as desired.

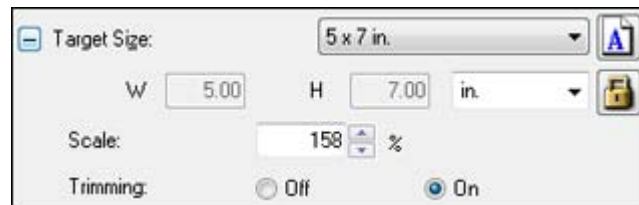

- **Scale:** Reduces or enlarges your image by the percentage you enter.
- **Trimming:** Turns automatic image cropping on or off.

-  Unlock icon: Unlocks the width/height proportions of the scanned image size so you can adjust it without constraint.

Parent topic: [Scanning in Professional Mode](#)

Image Preview Guidelines

You can preview your scanned image so you can adjust the scan settings using the preview as a guide. There are two types of preview available, depending on the scan mode and selected settings:

Thumbnail preview

A thumbnail preview displays your previewed images as thumbnails with the scanned image area and exposure automatically selected. If the **Thumbnail** checkbox is selected, clicking the **Preview** button opens a thumbnail preview.

Normal preview

A normal preview displays your previewed images in their entirety so you can select the scanned image area and other settings manually. If the **Thumbnail** checkbox is deselected, clicking the **Preview** button opens a normal preview.

Parent topic: [Selecting EPSON Scan Settings](#)

Scan Resolution Guidelines

If you plan to enlarge a scanned image so you can print it at a larger size, you may need to increase the resolution from the default resolution set by EPSON Scan. Follow these guidelines to determine the resolution setting you need:

- You will enlarge the image as you scan it.

If you will enlarge the image using EPSON Scan's Target Size setting (Home and Professional modes only), you do not need to increase the Resolution setting.

- You will scan the image at its original size, but enlarge it later in an image-editing program.

Increase EPSON Scan's Resolution setting in your scan. Increase the resolution by the same amount you will increase the image size to retain a high image quality. For example, if the resolution is 300 dpi (dots per inch) and you will double the image size later, change the Resolution setting to 600 dpi.

- You will scan the image at 100% or smaller size.

Select EPSON Scan's Resolution setting based on how you will use the scanned image:

- E-mail/view on a computer screen/post on the web: 96 to 150 dpi
- Print/convert to editable text (OCR): 300 dpi
- Fax: 200 dpi

Parent topic: [Selecting EPSON Scan Settings](#)

Selecting Scan File Settings

You can select the location, name, and format of your scan file on the File Save Settings window. You can also select various optional settings that control how EPSON Scan behaves when you scan and save files.

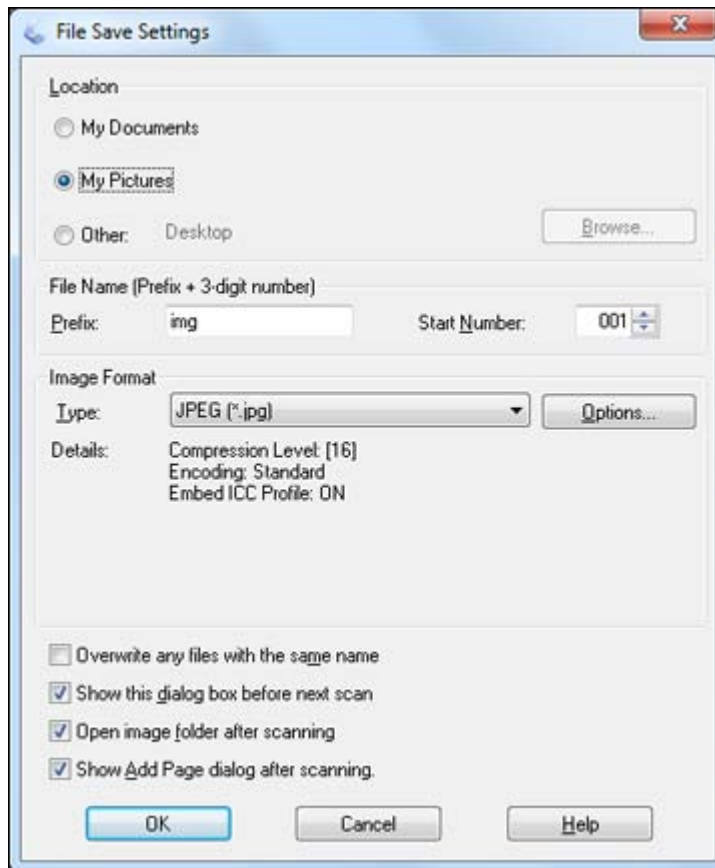

The File Save Settings window may appear after you click **Scan** on the EPSON Scan window. You may also be able to access the window by clicking the  icon on the EPSON Scan window.

1. Do one of the following to select the folder in which you want to save your scanned image:
 - Click the button for one of the displayed folders.
 - Click the **Other** button, click the **Browse** or **Choose** button, and select a folder.
2. Type in a stem file name in the **Prefix** field. This name is used along with numbers to automatically name your scanned files.
3. Select a different number as the **Start Number** setting, if you like.
4. Select the file format you want to use in the Image Format **Type** menu.
5. If your file format provides optional settings, click the **Options** button to select them.
6. Choose any of the optional settings you want to use by selecting their checkboxes.
7. Click **OK**.

[Available Scanned File Types and Optional Settings](#)

Parent topic: [Selecting EPSON Scan Settings](#)

Available Scanned File Types and Optional Settings

You can select from a variety scanned file types and optional settings on the File Save Settings window in EPSON Scan.

File Formats

Bitmap (*.bmp)

A standard image file format for most Windows programs.

JPEG (*.jpg)

An image format that lets you highly compress image data. However, the higher the compression, the lower the image quality. (The Tiff format is recommended when you need to modify or retouch your scanned image.)

Multi-Tiff (*.tif)

A Tiff file format when multiple pages are saved to the same file, allowing you to edit the images using a compatible program.

PDF (*.pdf)

A document format that is readable by Windows and Mac OS X systems using Adobe Reader, Acrobat, or other programs. You can save multi-page documents in one PDF file.

PICT (*.pct)

A standard image file format for most Mac OS X programs.

PRINT Image Matching II (*.jpg or *.tif)

File formats that include EPSON PRINT Image Matching II data for enhanced quality and a wider color range (does not affect the way the image displays on the screen).

Tiff (*.tif)

A file format created for exchanging data between many programs, such as graphic and DTP software.

Optional Settings**Overwrite any files with the same name**

Select to overwrite previous files with the same names.

Show this dialog box before next scan

Select to have the File Save Settings window appear automatically before you scan.

Open image folder after scanning

Select to have Windows Explorer or Mac OS X Finder automatically open to the folder where your scanned image is saved after scanning.

Show Add Page dialog after scanning

If you are scanning a multi-page document using the PDF or Multi-Tiff format, select to display a prompt for scanning additional pages after the first page is scanned.

Parent topic: [Selecting Scan File Settings](#)

Scanning with Mac OS X 10.6/10.7 Using Image Capture

With Mac OS X 10.6/10.7, you can scan with your product using an image-editing application such as Image Capture.

Note: With Mac OS X 10.6 or 10.7, in addition to scanning with Image Capture, you can download and install EPSON Scan scanning software. EPSON Scan provides additional image adjustment and photo correction features for enhancing scanned images, and provides an interface for TWAIN-compliant OCR scanning software, such as ABBYY FineReader. To download EPSON Scan, visit Epson's driver download site ([U.S. downloads](#) or [Canadian downloads](#)).

1. Open an image editing application, such as Image Capture.
2. Select your EPSON product from the **DEVICES** or **SHARED** list, if necessary.
3. If you see the **Show Details** button, click it.

If you are scanning an item on the scanner glass, your product begins a preview scan.

4. Select the **Scan Mode** setting indicating where you placed your original (if available). Select any other scan settings as necessary.

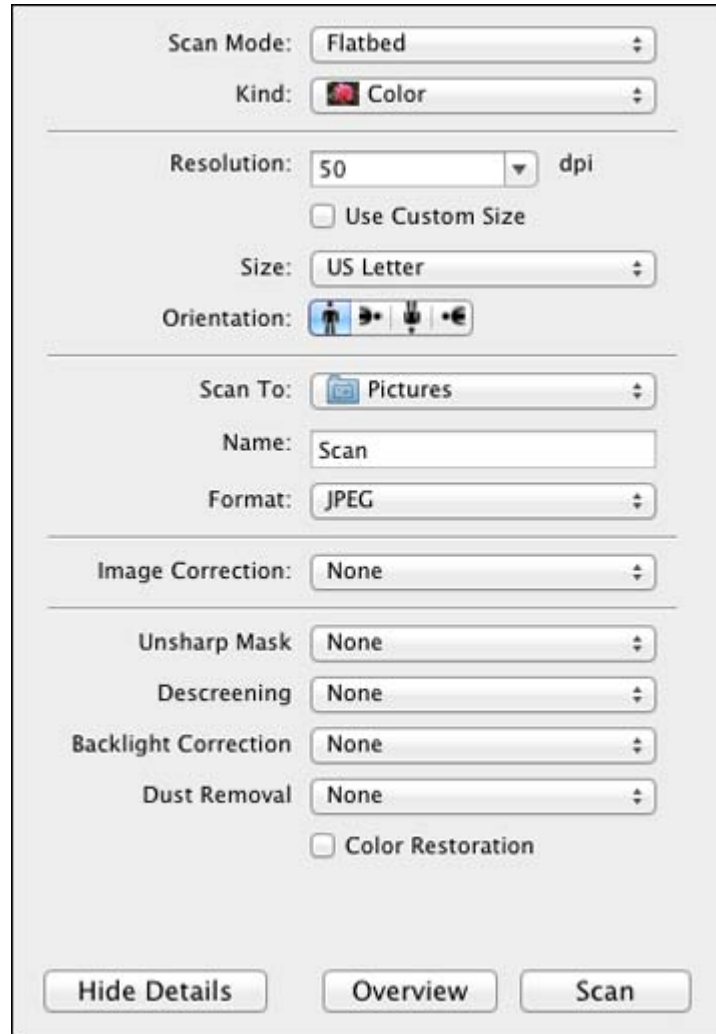

The image shows a scanning software settings dialog box with the following options:

- Scan Mode: Flatbed
- Kind: Color
- Resolution: 50 dpi
- Use Custom Size
- Size: US Letter
- Orientation: Portrait (indicated by a vertical icon)
- Scan To: Pictures
- Name: Scan
- Format: JPEG
- Image Correction: None
- Unsharp Mask: None
- Descreening: None
- Backlight Correction: None
- Dust Removal: None
- Color Restoration

At the bottom of the dialog are three buttons: Hide Details, Overview, and Scan.

5. Select the folder in which you want to save your scanned file in the **Scan To** pop-up menu.
6. Click **Scan**.

Your scanned file is saved in the folder you selected.

Parent topic: [Scanning](#)

Scanning Special Projects

Your product's scanning software offers various options to help you quickly complete special scan projects.

[Scanning to a PDF File](#)

[Restoring Photo Colors as You Scan](#)

[Convert Scanned Documents to Editable Text \(OCR\)](#)

Parent topic: [Scanning](#)

Scanning to a PDF File

Using EPSON Scan, you can scan a multi-page document and save it in one PDF (Portable Document Format) file on your computer.

1. Place your original on your product for scanning.
2. Start EPSON Scan.
3. Select the scan mode you want to use.
4. Select the scan settings for your scan.
5. Preview your image.
6. When you finish selecting all your settings, click **Scan**.

You see the File Save Settings window.

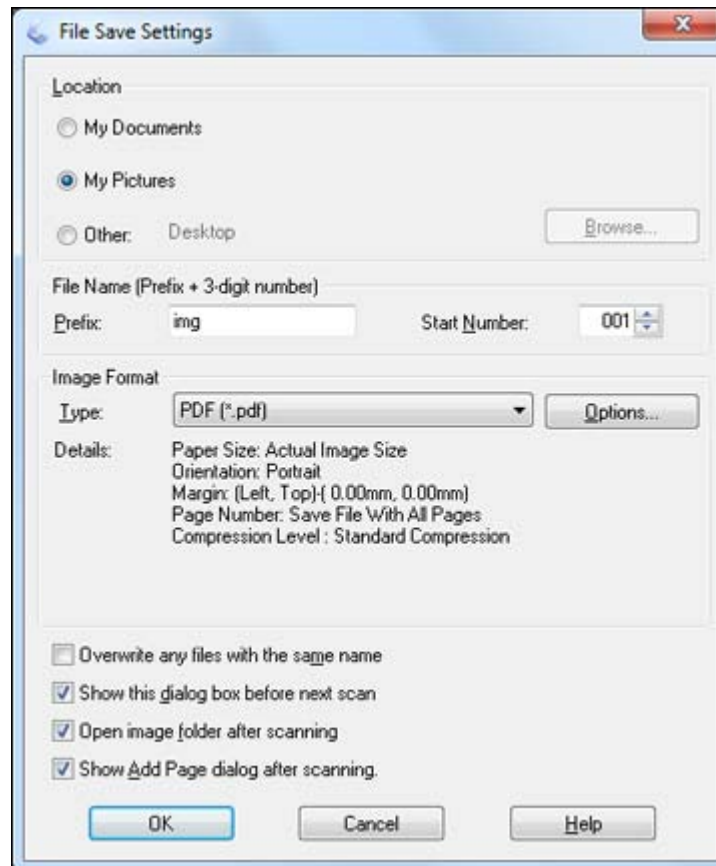

7. Select **PDF** as the Type setting.
8. Select any other settings you want to use on the File Save Settings window. Click the **Options** button to access additional settings.
9. Click **OK**.

EPSON Scan scans your document and you see this window:

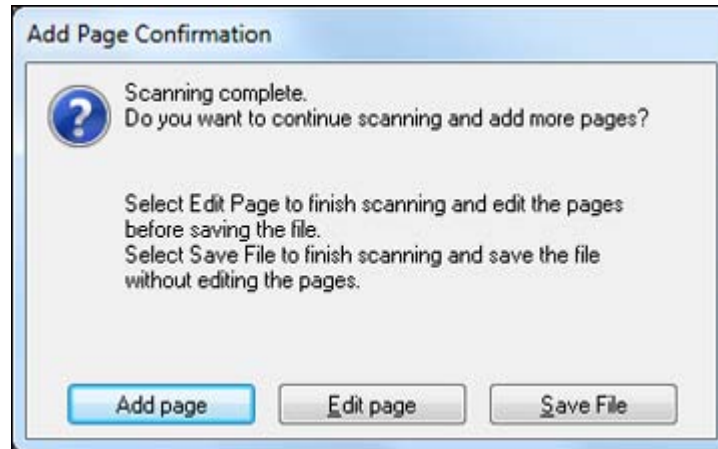

10. Choose one of the following options on the screen:

- If you are scanning only one page, click **Save File**.
- If you need to scan additional pages in a document, click **Add Page**. Place additional pages on the product for scanning, click **Scan**, and repeat until you have scanned all the pages. When you are finished, click **Save File**.
- If you need to delete or reorder the scanned pages, click **Edit Page**. Delete or reorder the pages using the icons that appear on the bottom of the editing window. When you are finished, click **OK**.

Note: If you installed an OCR (Optical Character Recognition) program, you may see a screen indicating the program is converting your page to text. Wait until the program re-scans the page and close the program, if necessary.

11. Click **Close** to exit the EPSON Scan window, if necessary.

EPSON Scan scans your original, and saves the PDF file in the selected folder or opens it in your scanning program. If the file was saved directly to your computer, you see the file in the Windows Explorer or Mac OS X Finder, where you can view and print the document, if desired.

Parent topic: [Scanning Special Projects](#)

Related tasks

[Selecting the Scan Mode](#)

[Selecting Scan File Settings](#)

Related topics

[Starting a Scan](#)

[Selecting EPSON Scan Settings](#)

Restoring Photo Colors as You Scan

You can restore the colors in faded photos as you scan them using EPSON Scan's Color Restoration setting. You can select this setting in any of the available scan modes.

Note: Color restoration is not available in Office Mode, if EPSON Scan offers that mode.

1. Place your original on your product for scanning.
2. Start EPSON Scan.
3. Select the scan mode you want to use.
4. Select the scan settings for your scan.
5. Preview your image.
6. Locate or access the image adjustment settings.
7. Select the **Color Restoration** checkbox.



8. When you finish selecting all your settings, click **Scan**.
9. Click **Close** to exit the EPSON Scan window, if necessary.

EPSON Scan scans your original, and saves the color-restored file in the selected folder or opens it in your scanning program. If the file was saved directly to your computer, you see the file in the Windows Explorer or Mac OS X Finder, where you can view and print the image, if desired.

Parent topic: [Scanning Special Projects](#)

Related tasks

[Selecting the Scan Mode](#)

Related topics

[Starting a Scan](#)

[Selecting EPSON Scan Settings](#)

Convert Scanned Documents to Editable Text (OCR)

You can scan a document and convert the text into data that you can edit with a word processing, spreadsheet, or HTML-editing program. This process is called OCR (Optical Character Recognition).

To scan and use OCR, you need to install an OCR program, such as ABBYY FineReader.

In Mac OS X 10.6 or 10.7, you can use ABBYY FineReader to convert scanned documents to editable text by first using an application such as Image Capture. Scan and save your document in Image Capture, then open ABBYY FineReader, open the **Get Images From** pop-up menu, and select **File**. Select the conversion option you want to use, then select your scanned file and follow the instructions on the screen.

Note: With Mac OS X 10.6 or 10.7, in addition to scanning with Image Capture, you can download and install EPSON Scan scanning software. EPSON Scan provides additional image adjustment and photo correction features for enhancing scanned images, and provides an interface for TWAIN-compliant OCR scanning software, such as ABBYY FineReader. To download EPSON Scan, visit Epson's driver download site ([U.S. downloads](#) or [Canadian downloads](#)).

[Scanning Using OCR - Windows](#)

[Scanning Using OCR - Mac OS X](#)

Parent topic: [Scanning Special Projects](#)

Scanning Using OCR - Windows

You can use the ABBYY FineReader OCR program to convert scanned documents to editable text.

1. Place your original on your product for scanning.
2. Click  or **Start > All Programs** or **Programs > ABBYY FineReader Sprint > ABBYY FineReader Sprint**.

You see this window:

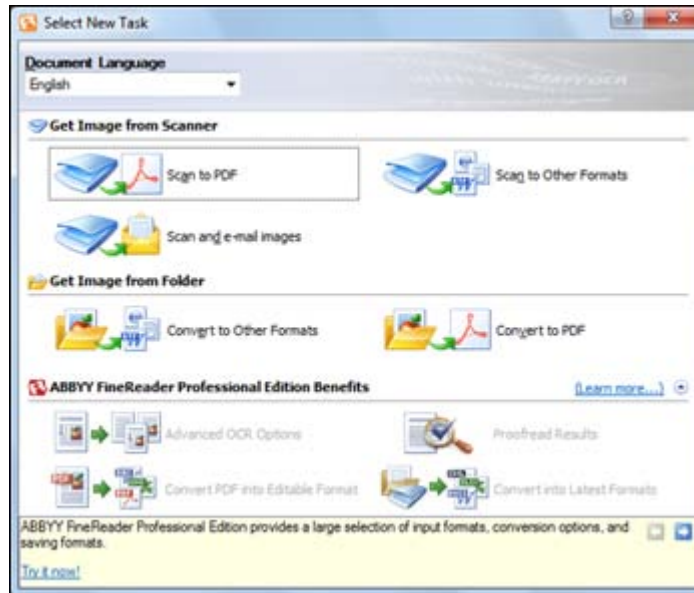

3. Select the language used in the document you are going to scan as the **Document Language** setting.
4. Click the **Scan to Other Formats** icon.
5. If you see the Select Scanner window, select your product and click **OK**.

Note: Do not select a **WIA** option for your product; it will not work correctly.

You see the scan settings window.

6. Select your scan settings.
7. Click **Preview** and adjust the area you want to scan, if necessary.
8. Click **Scan**.

Note: To scan a multi-page document, select settings in the Multi-Page Scanning section and click **Scan** for each page.

9. When you are finished scanning, click **Close**.

Your document is scanned and processed into editable text, then you see the Save As window.

10. Select a name and a file format for your document and click **Save**.

The file is saved and then opened in an application associated with the file type you selected, if available on your system.

Parent topic: [Convert Scanned Documents to Editable Text \(OCR\)](#)

Scanning Using OCR - Mac OS X

You can use the ABBYY FineReader OCR program to convert scanned documents to editable text.

In Mac OS X 10.6 or 10.7, you can use ABBYY FineReader to convert scanned documents to editable text by first using an application such as Image Capture. Scan and save your document in Image Capture, then open ABBYY FineReader, open the **Get Images From** pop-up menu, and select **File**. Select the conversion option you want to use, then select your scanned file and follow the instructions on the screen.

Note: With Mac OS X 10.6 or 10.7, in addition to scanning with Image Capture, you can download and install EPSON Scan scanning software. EPSON Scan provides additional image adjustment and photo correction features for enhancing scanned images, and provides an interface for TWAIN-compliant OCR scanning software, such as ABBYY FineReader. To download EPSON Scan, visit Epson's driver download site ([U.S. downloads](#) or [Canadian downloads](#)).

1. Place your original on your product for scanning.
2. Open the **Applications** folder and click the **ABBYY FineReader Sprint** icon.

You see this window:



3. Open the **Get Images From** pop-up menu and select your product.
4. Select the language used in the document you are going to scan as the **Document Language** setting.
5. Select the type of document you are going to scan.
EPSON Scan starts in the last scan mode you used.
6. Select your scan settings and click **Scan**.
Your document is scanned and you see the EPSON Scan window while your document is converted to editable text.
7. Click **Close** to close the EPSON Scan window and Preview window, if necessary.

You see the Save Converted File As window:

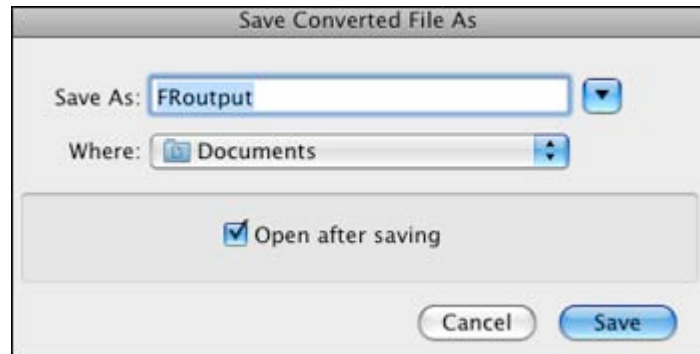

8. Click the **Save** button.

The file is saved and then opened in an application associated with the file type you selected, if available on your system.

Parent topic: [Convert Scanned Documents to Editable Text \(OCR\)](#)

Faxing

See these sections to fax using your product.

Note: This product allows you to store names, telephone numbers, and fax data in its memory even when the power is turned off. Make sure you restore all of the default settings if you give away or dispose of the product. This will erase all of your network settings and fax data.

[Connecting a Telephone or Answering Machine](#)

[Setting Up Fax Features](#)

[Setting Up Speed Dial and Group Dial Lists](#)

[Sending Faxes](#)

[Receiving Faxes](#)

Connecting a Telephone or Answering Machine

You must connect your product to a telephone wall jack to send or receive faxes. If you want to use the same telephone line to receive calls, you can connect a telephone or answering machine to your product using an additional phone cable.

Note: If you do not connect a telephone to your product, make sure to turn on **Auto Answer**. Otherwise, you cannot receive faxes.

1. Connect the phone cable to your telephone wall jack and to the **LINE** port on your product.

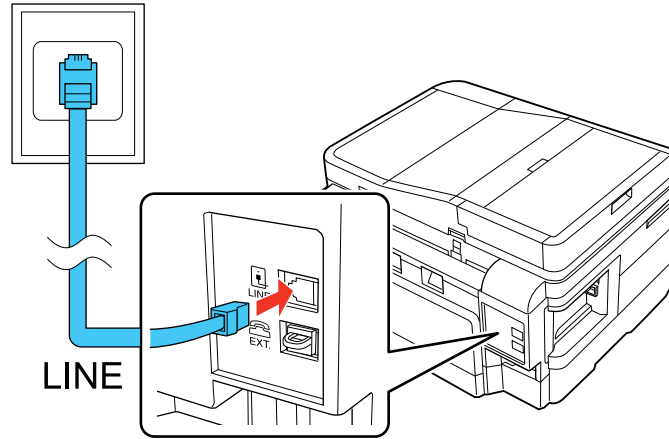

Note: If your telephone line included a DSL Internet connection, you must connect a DSL filter to the wall jack to be able to use the line for faxing or voice calls using your product. Contact your DSL provider for the necessary filter.

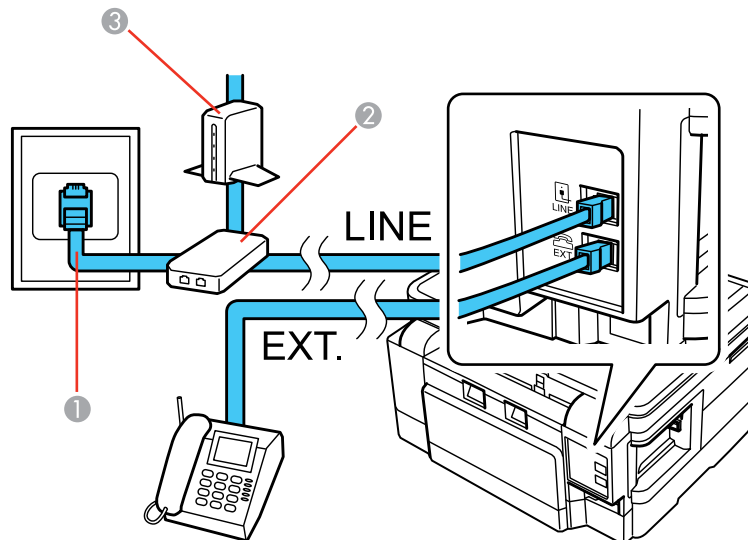

- 1 Telephone wall jack
- 2 DSL filter
- 3 DSL modem

2. If you are connecting a telephone or answering machine to your product using a second phone cable, remove the cap from the **EXT** port on your product.

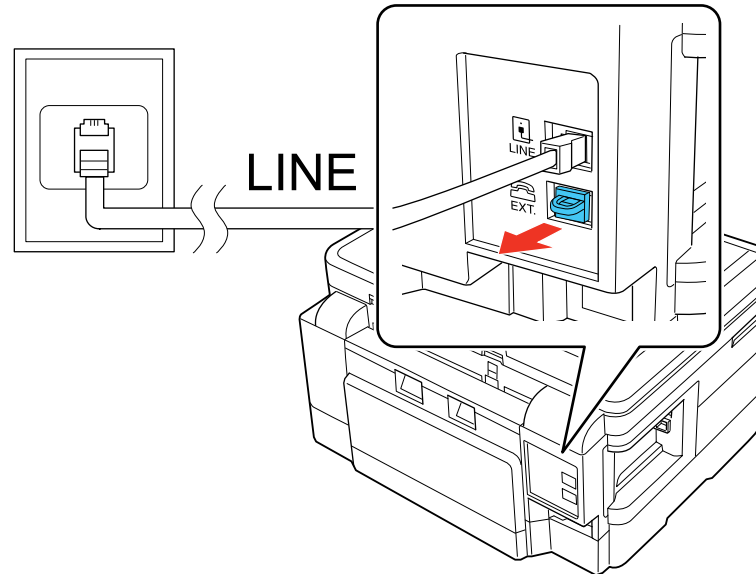

3. Connect the second phone cable to your telephone or answering machine and to the **EXT** port on your product.

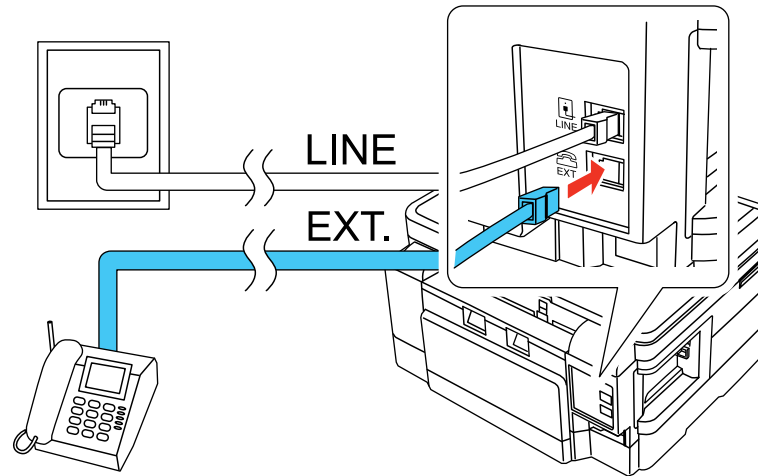

Note: If you connect an answering machine and **Auto Answer** is turned on, make sure the product's **Rings to Answer** setting is set higher than the number of rings your answering machine is set to answer a call.

Any phone or answering machine must be connected to the **EXT** port for your product to detect an incoming fax call when the phone is picked up. Epson cannot guarantee compatibility with VoIP, cable phone systems, or fiberoptic digital services such as FIOS.

Parent topic: [Faxing](#)

Setting Up Fax Features

Before faxing with your product, set up your fax header and select the fax features you want to use.

Note: If you leave your product unplugged for a long period of time, you may need to reset the date and time settings for faxes.

[Setting Up Fax Features Using the Product Control Panel](#)

[Setting Up Fax Features Using the Fax Utility - Windows](#)

[Setting Up Fax Features Using the Fax Utility - Mac OS X](#)

Parent topic: [Faxing](#)

Setting Up Fax Features Using the Product Control Panel

See these sections to set up fax features using the product control panel.

[Selecting Your Country or Region](#)

[Selecting the Date and Time](#)

[Entering Fax Header Information](#)

[Entering Numbers and Characters for Faxing](#)

[Selecting Fax Send and Receive Settings](#)

[Selecting Fax Communication Settings](#)

[Printing Fax Reports](#)

[Restoring Default Fax Settings](#)

[Fax Scan & Print Options](#)

[Fax Communications Options](#)

[Fax Report Options](#)

[Restore Default Settings Options](#)

Parent topic: [Setting Up Fax Features](#)

Selecting Your Country or Region

Before faxing, select the country or region in which you are using your product.

Note: If you change the country or region, your fax settings return to their defaults and you must select them again.

1. Press the  home button if necessary
2. Select **Setup**.



3. Select **Printer Setup**.

You see this screen:



4. Press the arrow buttons and select **Country/Region**.
5. Select your country or region.
You see a confirmation screen.
6. If the setting is correct, select **Yes**. (If not, select **No** and retry.)

Note: Changing the country or region will restore the fax settings to the default settings.

Parent topic: [Setting Up Fax Features Using the Product Control Panel](#)

Selecting the Date and Time

Before faxing, select the current date, time, and daylight saving phase in your area, and choose your preferred date and time format.

1. Press the  home button, if necessary
2. Select **Setup**.



3. Select **Printer Setup**.

You see this screen:



4. Select **Date/Time**.

You see this screen:



5. Select the date format you want to use.
6. Use the number buttons on the control panel to enter the current date, then press the **OK** button.
7. Select the time format you want to use.
8. Use the number buttons on the control panel to enter the current time, select **AM** or **PM** if you selected a 12-hour time format, then press the **OK** button.
9. Select **Daylight Saving Time**.
10. Press the arrow buttons and select one of the following settings for the current conditions in your area:
 - **Summer**: it is spring or summer and your region uses Daylight Saving Time (DST)
 - **Winter**: it is fall or winter or your region does not use Daylight Saving Time (DST)

After making a selection, you return to the **Printer Setup** screen.

Note: If your region uses Daylight Saving Time (DST), you must change this setting to match the season. When you change from **Winter** to **Summer**, your product automatically sets its clock ahead one hour. When you change from **Summer** to **Winter**, it sets the clock back one hour.

Parent topic: [Setting Up Fax Features Using the Product Control Panel](#)

Entering Fax Header Information

Before faxing, add your sender name and fax number to the fax header to identify the source of the faxes you send.

1. Press the  home button if, necessary
2. Select **Setup**.



3. Press the arrow buttons and select **Fax Settings**.

You see this screen:



4. Press the arrow buttons and select **Header**.
5. Select **Fax Header**.

You see this screen:



6. Use the keypad to enter the sender name for your fax source, such as your name or a business name. You can enter up to 40 characters.
7. Press the **OK** button to return to the Header menu.
8. Select **Your Phone Number**.
9. Use the numeric buttons on the control panel to enter your fax number, up to 20 characters. You do not need to use dashes. For international numbers that require use of a + symbol, press the # button.
10. Press the **OK** button to return to the Header menu.

Parent topic: [Setting Up Fax Features Using the Product Control Panel](#)



Related tasks

[Entering Numbers and Characters for Faxing](#)

Entering Numbers and Characters for Faxing

Follow these guidelines to enter numbers and characters for setting up your fax settings. You can use the LCD keypad described here or the numeric buttons on the product control panel.



- Press the arrow buttons to move the cursor to the previous or next character.
- Press the number buttons repeatedly to select uppercase letters (ABC), lowercase letters (abc), or numbers (123) and symbols. You can also use the numeric keypad on the product control panel.
- To enter a space, select .
- To delete characters, select .
- When you finish entering characters, press the **OK** button.

Parent topic: [Setting Up Fax Features Using the Product Control Panel](#)

Selecting Fax Send and Receive Settings

You can select the paper source, fax quality, and other settings for incoming and outgoing faxes.

1. Press the  home button if, necessary

2. Select **Setup**.



3. Press the arrow buttons and select **Fax Settings**.

You see this screen:



4. Select **Scan & Print Setup**.
5. Change any of the available settings.

Parent topic: [Setting Up Fax Features Using the Product Control Panel](#)

Related references

[Fax Send Options](#)

[Fax Sending Options](#)

[Fax Scan & Print Options](#)

Selecting Fax Communication Settings

You can customize how your product sends and receives faxes over your phone line.

1. Press the  home button if, necessary
2. Select **Setup**



3. Press the arrow buttons and select **Fax Settings**.

You see this screen:



4. Select **Communication**.
5. Change any of the available settings.

Parent topic: [Setting Up Fax Features Using the Product Control Panel](#)

Related references

[Fax Communications Options](#)

Printing Fax Reports

You can run a variety of reports on your fax transmissions and print your speed and group dial lists.

1. Make sure you loaded letter-size or legal-size paper in your product.
2. Select **Fax**.



3. Press the  menu button.
4. Press the arrow buttons and select **Fax Report**.

You see this screen:



5. Select one of the available reports.
6. If you selected **Fax Log**, select **Print** or **View**
7. Press the  start button to print the report.

Parent topic: [Setting Up Fax Features Using the Product Control Panel](#)

Restoring Default Fax Settings

You can restore your fax settings to their default options, if necessary.

1. Press the  home button, if necessary

2. Select **Setup**.



3. Press the arrow buttons and select **Restore Default Settings**.

You see this screen:

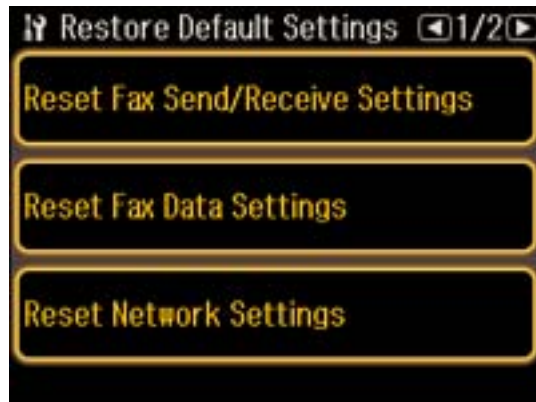

4. Select one of the available options.
You see a confirmation screen.
5. Select **Yes** or **No**.

Parent topic: [Setting Up Fax Features Using the Product Control Panel](#)

Fax Scan & Print Options

Set the **Scan & Print** options you want to use for incoming faxes.

Setting	Options	Description
Resolution	Standard	Provides good scan resolution and print quality for most faxes.
	Fine	Provides best scan resolution and print quality for faxes of small print and line art.
	Photo	Provides best scan resolution and print quality for faxed photos.
Contrast	-4 to +4	Adjusts the contrast for faxes; negative settings make faxes lighter and positive settings make faxes darker.
Paper Size	Letter	Sets the size of the paper loaded for incoming faxes.
	Legal	
	A4	
Paper Source	Cassette1	Sets the paper source for incoming faxes.
	Cassette 2	
	Cassette 1 Then 2	
Auto Reduction	On	Reduces size of incoming faxes to fit on the paper in the selected Paper Source .
	Off	Prints incoming faxes in original size or on multiple sheets, if loaded paper size is smaller.
Last Transmission Report	Off	Does not print a report on the last transmitted fax after you send a fax.
	On Error	Prints a report on the last transmitted fax only if a fax error occurs (default setting).
	On Send	Prints a report on the last transmitted fax after every fax you send.

Parent topic: [Setting Up Fax Features Using the Product Control Panel](#)

Fax Communications Options

Set the **Communication** options you want to use for faxing over your phone line.

Setting	Options	Description
DRD	All	If you are using a Distinctive Ring Service on your phone line, your telephone company can assign two or more phone numbers to the same line and assign different ring patterns to each. If you use this service, select the number of rings for your fax number as the DRD setting so your product can receive faxes on the correct number of rings. All is the default setting and works for phone lines that do not use this service.
	Single	
	Double	
	Triple	
	Double & Triple	
ECM	On	Turns on Error Correction Mode (ECM) to automatically request retransmission of faxes received with detected errors (default setting).
	Off	Turns off Error Correction Mode (ECM).
V.34	On	Transmits faxes at 33.6 Kbps (default setting).
	Off	Transmits faxes at 14.4 Kbps.
Rings to Answer	1 to 9	Sets the number of rings before your product receives a fax. The default setting is 4 . If Auto Answer is turned on and an answering machine is connected to the product, make sure this setting is set higher than the number of rings your answering machine is set to answer a call.
Dial Tone Detection	On	Automatically dials the phone number you enter to send a fax when the product detects a dial tone on the line.
	Off	Turns off automatic dial tone detection. This is necessary if you connected your product to a phone line on a Private Branch Exchange (PBX) or Terminal Adapter (TA) system.

Parent topic: [Setting Up Fax Features Using the Product Control Panel](#)

Fax Report Options

Select the **Fax Report** you want to print.

Fax Log

View or print a report on recent fax transmissions.

Last Transmission

Print a report on your last fax transmission.

Speed Dial List

Print a list of your speed dial entries.

Group Dial List

Print a list of your group dial entries.

Reprint Faxes

Reprint the most recent incoming fax.

Protocol Trace

Print a protocol trace of your last fax transmission.

Parent topic: [Setting Up Fax Features Using the Product Control Panel](#)

Restore Default Settings Options

Select the **Restore Default Settings** option for the settings you want to restore.

Reset Fax Send/Receive Settings

Restores all of the default fax settings on the **Fax Send Settings, Fax Scan and Print Settings, and Communication** screens.

Reset Fax Data Settings

Erases the speed dial list, group dial list, header, and fax log.

Reset Network Settings

Restores all of the default network settings.

Reset All Except Network & Fax Settings

Restores all of the default settings on the control panel, except for the network and fax settings.

Reset All Settings

Restores all of the default settings on the control panel.

Parent topic: [Setting Up Fax Features Using the Product Control Panel](#)

Setting Up Fax Features Using the Fax Utility - Windows

You can set up your fax header and select your fax settings using the FAX Utility for Windows.

1. Click  or **Start**.
2. Select **Programs** or **All Programs**.
3. Select **EPSON Software**.
4. Select **FAX Utility**.

You see this window:

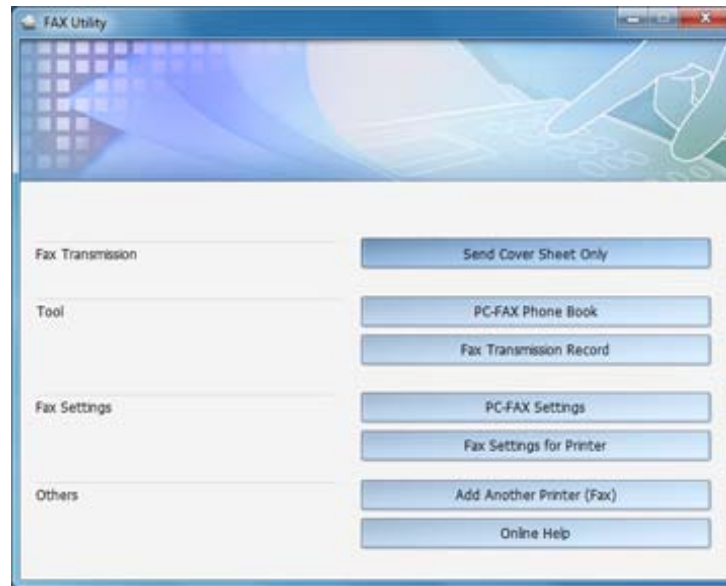

5. Select **Fax Settings for Printer**.

You see this window:



6. Select your product, if necessary.
7. Select **Fax Settings**.
8. Follow the prompts that appear on the screen to enter your fax header information and select your fax settings.

Note: For detailed information, select the FAX Utility **Help** option.

Parent topic: [Setting Up Fax Features](#)

Setting Up Fax Features Using the Fax Utility - Mac OS X

You can set up your fax header and select your fax settings using the FAX Utility for Mac OS X.

1. Do one of the following:
 - **Mac OS X 10.6/10.7:** In the Apple menu or the Dock, select **System Preferences**. Select **Print & Fax** or **Print & Scan**, select the **FAX** option for your product, and select **Options & Supplies**. Select **Utility** and select **Open Printer Utility**.
 - **Mac OS X 10.4/10.5:** In the Apple menu or the Dock, select **System Preferences**. Select **Print & Fax**, select the **FAX** option for your product, and select **Open Print Queue** or **Print Queue**. Select **Utility**.

2. Double-click **FAX Utility**, if necessary.

You see this window:



3. Select your **FAX** product in the Printer list.
4. Select **Fax Settings**.
5. Follow the prompts that appear on the screen to enter your fax header information and select your fax settings.

Note: For detailed information, select the FAX Utility ? icon.

Parent topic: [Setting Up Fax Features](#)

Setting Up Speed Dial and Group Dial Lists

You can set up a speed dial list of fax numbers so you can quickly select them for faxing. You can also set up a group dial list to send a fax message to multiple speed dial numbers.

See these sections to set up speed dial and group dial lists.

[Setting Up Speed/Group Dial Lists Using the Product Control Panel](#)

[Setting Up Speed/Group Dial Lists Using the Fax Utility - Windows](#)

[Setting Up Speed/Group Dial Lists Using the Fax Utility - Mac OS X](#)

Parent topic: [Faxing](#)

Setting Up Speed/Group Dial Lists Using the Product Control Panel

You can set up your speed dial and group dial lists using the control panel on your product.

[Creating Speed Dial List Entries](#)

[Printing Your Speed Dial List](#)

[Creating Group Dial List Entries](#)

[Printing Your Group Dial List](#)

Parent topic: [Setting Up Speed Dial and Group Dial Lists](#)

Creating Speed Dial List Entries

You can create a speed dial list of fax numbers to help you quickly send faxes.

Note: You can create up to 60 speed dial and group dial entries combined.

1. Press the  home button, if necessary.
2. Select **Fax**.



3. Press the  menu button.

You see this screen:

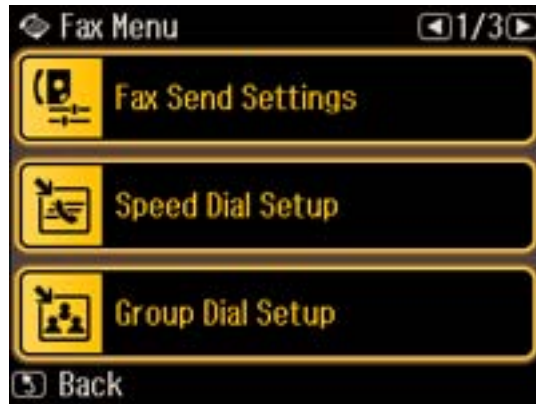

4. Select **Speed Dial Setup**.
5. Select **Create**.

You see this screen:

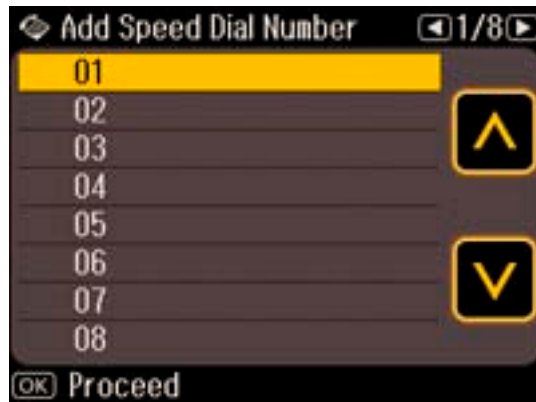

6. Select the number you want to use for the fax number you are adding and press the **OK** button.
7. Use the numeric buttons on the control panel to enter the fax number. You can enter up to 64 characters.
8. Press the **OK** button.

You see this screen:



9. Use the keypad to enter a name for the speed dial entry. You can enter up to 40 characters.
10. Press the **OK** button.
You return to the Speed Dial Setup screen.
11. Do the following as necessary:
 - To create additional entries, select **Create** and repeat the steps above.
 - To edit an existing entry, select **Edit**, select the entry, and change the information.
 - To delete an entry, select **Delete**, select the entry, and confirm the deletion.

Parent topic: [Setting Up Speed/Group Dial Lists Using the Product Control Panel](#)

Related tasks

[Entering Numbers and Characters for Faxing](#)

Printing Your Speed Dial List

You can print your speed dial list for easy reference.

1. Make sure you loaded letter-size or larger paper in your product.
2. Press the  home button, if necessary.

3. Select **Fax**.



4. Press the  menu button.

You see this screen:



5. Press the arrow buttons and select **Fax Report**.

You see this screen:



6. Select **Speed Dial List**.
7. Press the ◊ start button to print the report.

Parent topic: [Setting Up Speed/Group Dial Lists Using the Product Control Panel](#)

Creating Group Dial List Entries

You can create a group dial list after creating a speed dial list. Each group dial list can include up to 30 fax numbers.

Note: You can create up to 60 speed dial and group dial entries combined.

1. Press the 🏠 home button, if necessary.

2. Select **Fax**.



3. Press the  menu button.

You see this screen:



4. Select **Group Dial Setup**.
5. Select **Create**.

You see this screen:



6. Select the number you want to use for the group dial entry you are adding.
You see this screen:



7. Use the keypad to enter a name for the group dial entry. You can enter up to 30 characters.
8. Press the **OK** button.
You see a screen similar to this:



9. Select the speed dial entry you want to add to the group, then select the check mark.
10. Continue selecting speed dial entries as necessary.
11. When you are finished, press the **OK** button.
You return to the Group Dial Setup screen.
12. Do the following as necessary:
 - To create additional entries, select **Create** and repeat the steps above.
 - To edit an existing entry, select **Edit**, select the entry, and change the information.
 - To delete an entry, select **Delete**, select the entry, and confirm the deletion.

Parent topic: [Setting Up Speed/Group Dial Lists Using the Product Control Panel](#)

Related tasks

[Entering Numbers and Characters for Faxing](#)

Printing Your Group Dial List

You can print your group dial list for easy reference.

1. Make sure you loaded letter-size or larger paper in your product.
2. Press the  home button, if necessary.

3. Press the **Fax** button.



4. Press the  menu button.
5. Press the arrow buttons and select **Fax Report**.

You see this screen:



6. Press the arrow buttons and select **Group Dial List**.
7. Press the  start button to print the report.

Parent topic: [Setting Up Speed/Group Dial Lists Using the Product Control Panel](#)

Setting Up Speed/Group Dial Lists Using the Fax Utility - Windows

You can set up your speed dial and group dial lists using the FAX Utility for Windows. The utility also lets you import fax numbers from the Windows Address Book and back up fax numbers stored in your product's memory.

Note: You can create up to 60 speed dial and group dial entries combined.

1. Click  or **Start**.
2. Select **Programs** or **All Programs**.
3. Select **EPSON Software**.
4. Select **FAX Utility**.

You see this window:

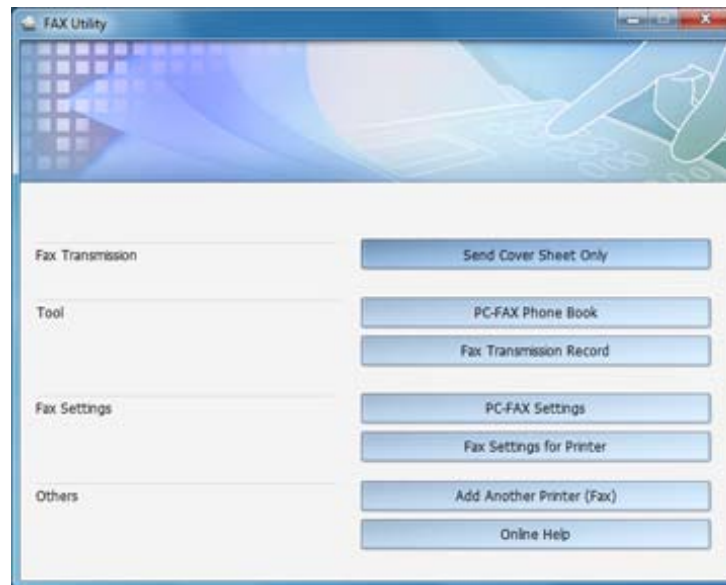

5. Select **Fax Settings for Printer**.

You see this window:

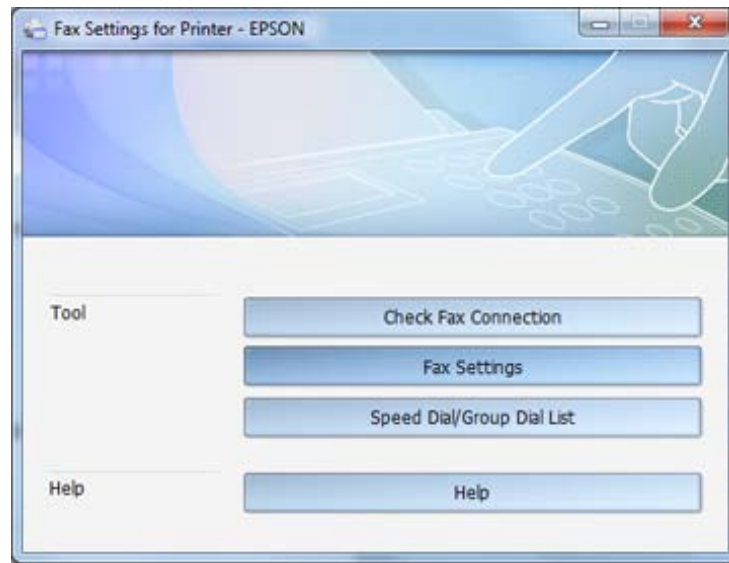

6. Select your product, if necessary.
7. Select **Speed Dial/Group Dial List**.
You see this window:

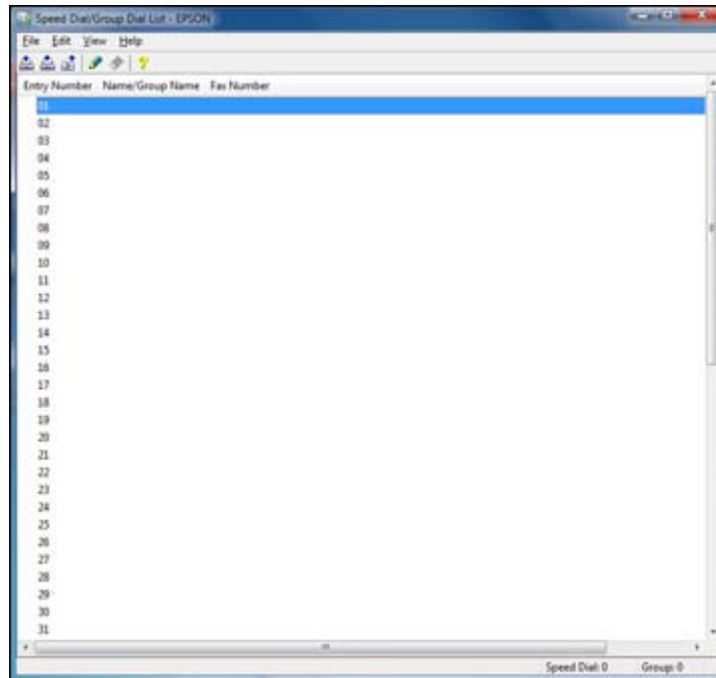

8. Select an empty entry and click the  icon.

Note: To edit an entry, select it and click the  icon. To delete an entry, select it and click the  icon.

9. Do one of the following:

- To create a speed dial entry, select **Speed Dial**, enter a name and fax number, and click **OK**.
- To create a group dial entry, select **Group**, enter a name, select your desired fax numbers, and click **OK**.

10. Repeat the previous step as necessary to add all your speed dial or group dial entries.

11. When you are finished, click the  icon to save the entries to your product's memory.

Parent topic: [Setting Up Speed Dial and Group Dial Lists](#)

Setting Up Speed/Group Dial Lists Using the Fax Utility - Mac OS X

You can set up your speed dial and group dial lists using the FAX Utility. The utility also lets you import fax numbers from the MacAddress Book and back up fax numbers to your product's memory.

Note: You can create up to 60 speed dial and group dial entries combined.

1. Do one of the following:
 - **Mac OS X 10.6/10.7:** In the Apple menu or the Dock, select **System Preferences**. Select **Print & Fax** or **Print & Scan**, select the **FAX** option for your product, and select **Options & Supplies**. Select **Utility** and select **Open Printer Utility**.
 - **Mac OS X 10.4/10.5:** In the Apple menu or the Dock, select **System Preferences**. Select **Print & Fax**, select the **FAX** option for your product, and select **Open Print Queue** or **Print Queue**. Select **Utility**.
2. Double-click **FAX Utility**, if necessary.

You see this window:



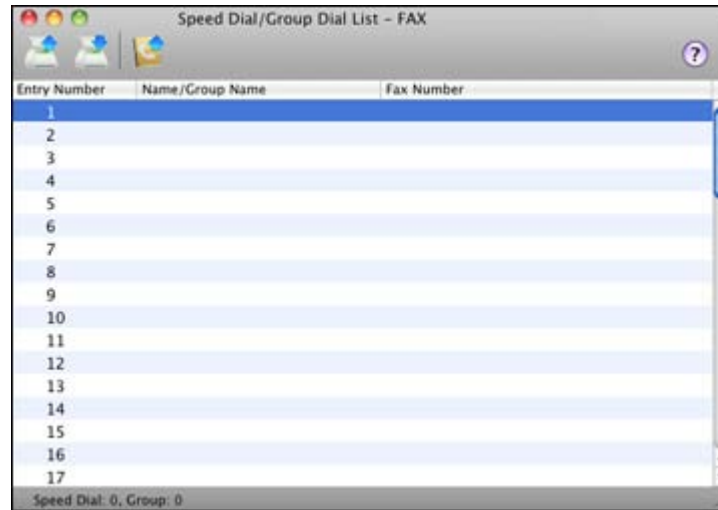

3. Select your **FAX** product in the Printer list.
4. Select **Speed Dial/Group Dial List**.

You see this window:



5. To add an entry, double-click an empty entry.

Note: To edit an entry, select it and change the information. To delete an entry, select it and press the **Delete** key on your keyboard.

6. Do one of the following:
 - To create a speed dial entry, select **Speed Dial**, enter a name and fax number, and click **OK**.
 - To create a group dial entry, select **Group Dial**, enter a name, select your desired fax numbers, and click **OK**.
7. Repeat the previous steps as necessary to add all your speed dial or group dial entries.
8. To import entries from your MacAddress book, click the  icon.
9. When you are finished, click the  icon to save the entries to your product's memory.

Parent topic: [Setting Up Speed Dial and Group Dial Lists](#)

Sending Faxes

See these sections to send faxes using your product.

[Sending Faxes from the Product Control Panel](#)

[Sending Faxes Using the Fax Utility - Windows](#)
[Sending Faxes Using the Fax Utility - Mac OS X](#)

Parent topic: [Faxing](#)

Sending Faxes from the Product Control Panel

See these sections to send faxes using the product's control panel.

[Manually Dialing or Redialing Fax Numbers](#)

[Selecting Fax Numbers from Speed or Group Dial Lists](#)

[Dialing Fax Numbers from a Connected Telephone](#)

[Fax Send Options](#)



Parent topic: [Sending Faxes](#)

Manually Dialing or Redialing Fax Numbers

You can send a fax from your product control panel by manually dialing the fax number or redialing the last dialed fax number.

1. Place your original on the product for faxing.
2. Press the  home button, if necessary.
3. Select **Fax**.



4. Do one of the following:
 - Select **Send Fax**, use the numeric keypad to enter the fax number, and press the **OK** button. You can enter up to 64 characters.
 - Select **Redial** to redial the last dialed fax number.
5. If you need to change any fax settings, press the  menu button, select **Fax Send Settings**, and select your settings. When you finish selecting settings, press the **OK** button.
6. Press the  start button.

Note: If your recipient's fax machine does not print in color, your fax is automatically sent in black-and-white. To cancel faxing, select **Cancel**.

Your product scans your original and prompts you to place additional pages, if necessary.

After scanning your originals, your product dials the number and sends the fax.

Note: If the number is busy or there is a communication problem, your product displays a redialing message and will redial the number in a few minutes.

Parent topic: [Sending Faxes from the Product Control Panel](#)



Selecting Fax Numbers from Speed or Group Dial Lists

You can send a fax from your product control panel by selecting a speed dial or group dial entry from the list.

1. Place your original on the product for faxing.
2. Press the  home button, if necessary.

3. Select **Fax**.



4. Select **Speed Dial** or **Group Dial**.
5. Select the speed dial or group dial entry you want to fax.
6. If you need to change any fax settings, press the  menu button, select **Fax Send Settings**, and select your settings. When you finish selecting settings, press the **OK** button.
7. Press the  start buttons.

Note: If your recipient's fax machine does not print in color, your fax is automatically sent in black-and-white. To cancel faxing, select **Cancel**.

Your product scans your original and prompts you to place additional pages, if necessary.

After scanning your originals, your product dials the number and sends the fax.

Note: If the number is busy or there is a communication problem, your product displays a redialing message and will redial the number in a few minutes.

Parent topic: [Sending Faxes from the Product Control Panel](#)

Dialing Fax Numbers from a Connected Telephone

If you have connected a telephone to the **EXT** port on your product, you can send a fax by dialing the fax number from the connected telephone.

1. Place your original on the product for faxing.

2. Press the  home button, if necessary.
3. Select **Fax**.



4. If you need to change any fax settings, press the  menu button, select **Fax Send Settings**, and select your settings. When you finish selecting settings, press the **OK** button.
5. Dial the fax number from the connected telephone.

You see this screen:



6. Using your product control panel, select **Send**.

Note: Your product now communicates with the recipient's fax machine. Do not hang up the telephone.

7. Press the  start button.

Note: If your recipient's fax machine does not print in color, your fax is automatically sent in black-and-white. To cancel faxing, select **Cancel**.

Your product scans your original and prompts you to place additional pages, if necessary.

8. Hang up the telephone.

After scanning your originals, your product sends the fax.

Parent topic: [Sending Faxes from the Product Control Panel](#)

Fax Send Options

When you press the  menu button while sending a fax, you can select these **Fax Send Settings** options.

Setting	Options	Description
Resolution	Standard	Provides good scan resolution and print quality for most faxes.
	Fine	Provides best scan resolution and print quality for faxes of small print and line art.
	Photo	Provides best scan resolution and print quality for faxed photos.
Contrast	-4 to +4	Adjusts the contrast for faxes; negative settings make faxes lighter and positive settings make faxes darker.
2-Sided Scanning	Off	Lets you fax 2-sided originals placed in the ADF.
	On	
Send Fax Later	Off	Lets you set when a fax is transmitted.
	On	
	Time	

Parent topic: [Sending Faxes from the Product Control Panel](#)

Sending Faxes Using the Fax Utility - Windows

You can send a fax from a printing program in Windows. You can fax up to 100 pages at a time, including a cover sheet.

1. Open the file you want to fax and select the print command.

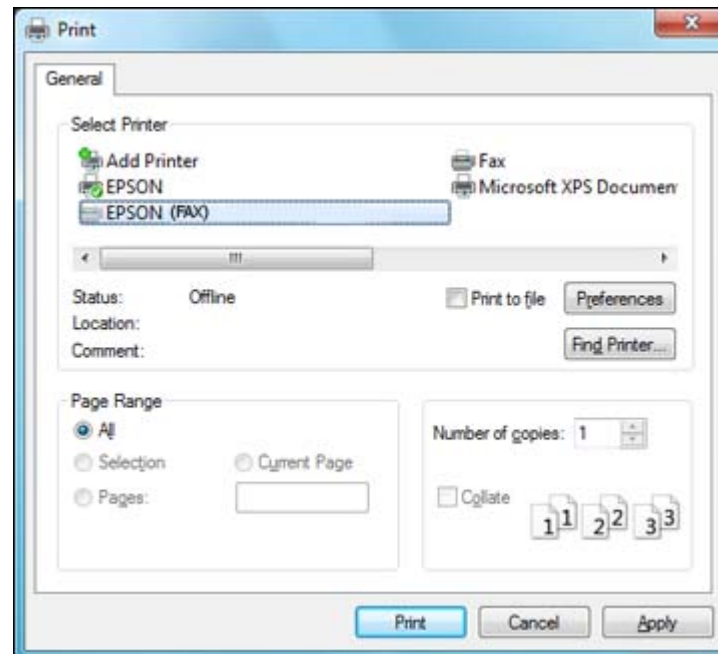

2. Select your product with the **FAX** option as the printer.
3. To change the Paper Size, Orientation, Color, Image Quality, or Character Density settings, click the **Preferences** or **Properties** button.

Note: If you see a **Setup**, **Printer**, or **Options** button, click it. Then click **Preferences** or **Properties** on the next screen. For more information about selecting fax print settings, click **Help**.

4. Select the Page Range as necessary. (Leave the Number of copies set to 1.)
5. Click **Print**.

If you're faxing for the first time, you see a window like this one:

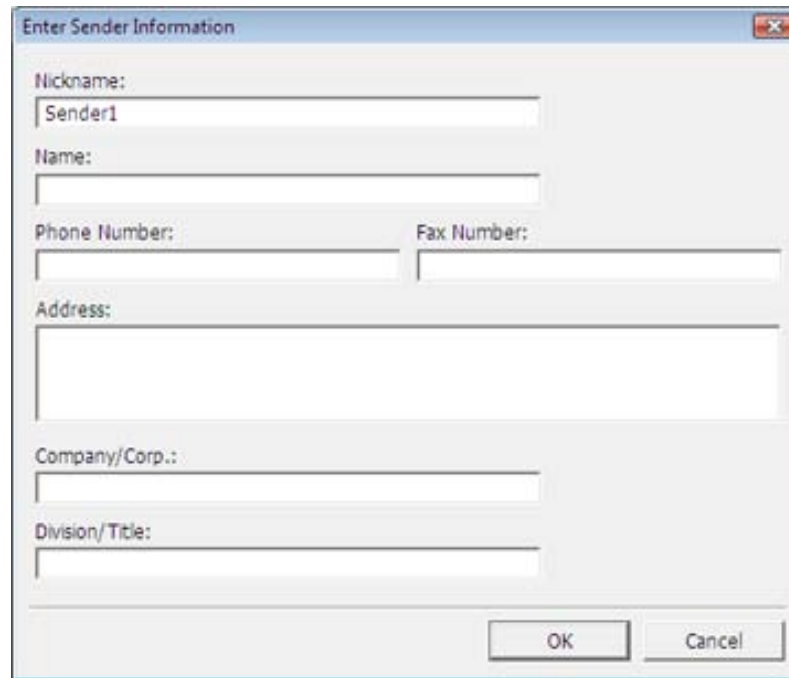

The image shows a Windows-style dialog box titled "Enter Sender Information". It contains the following fields and controls:

- Nickname:** A text box containing "Sender1".
- Name:** An empty text box.
- Phone Number:** An empty text box.
- Fax Number:** An empty text box.
- Address:** A large empty text box.
- Company/Corp.:** An empty text box.
- Division/Title:** An empty text box.
- Buttons:** "OK" and "Cancel" buttons at the bottom right.

6. Enter your sender information so that recipients can identify the origin of the fax. Then click **OK** to save the sender information.
7. Add a cover sheet, input a fax number, or set up a phone book of numbers for future use, then click **Next**.

Note: For detailed instructions on using the EPSON FAX Utility, click **Help**.

8. If you added a cover sheet to your fax, select a cover sheet style, enter your subject and comment information, then click **Next**.
9. Click **Send** to transmit your fax.

Parent topic: [Sending Faxes](#)

Sending Faxes Using the Fax Utility - Mac OS X

You can send a fax from a Mac OS X printing program using the FAX Utility. You can fax up to 100 pages at a time, including a cover sheet.

1. Open the file you want to fax.
2. Select the print command in your application.

Note: You may need to select a print icon on your screen, the **Print** option in the **File** menu, or another command. See your application's help utility for details.



3. Select your product **FAX** option as the **Printer** setting.
4. Select the number of pages you are faxing as the **Pages** setting.

Note: Leave the **Copies** setting set to **1**.

5. Select **Recipient Settings** from the pop-up menu.

You see this window:

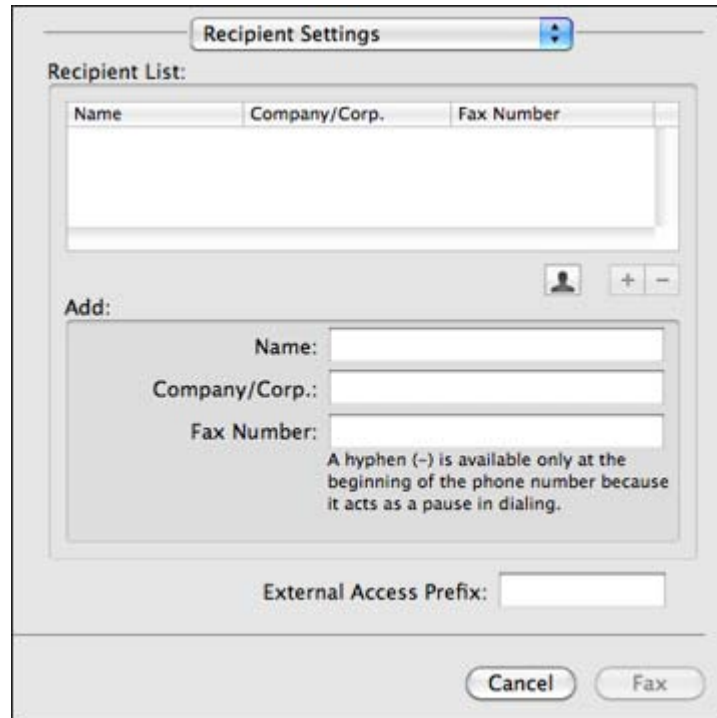

The image shows a 'Recipient Settings' dialog box. At the top, there is a title bar with the text 'Recipient Settings' and a close button. Below the title bar, the text 'Recipient List:' is followed by a table with three columns: 'Name', 'Company/Corp.', and 'Fax Number'. The table is currently empty. To the right of the table are three buttons: a person icon, a plus sign, and a minus sign. Below the table, the text 'Add:' is followed by three input fields labeled 'Name:', 'Company/Corp.:', and 'Fax Number:'. Below these fields is a note: 'A hyphen (-) is available only at the beginning of the phone number because it acts as a pause in dialing.' At the bottom of the dialog box, there is an 'External Access Prefix:' label followed by an input field. At the very bottom, there are two buttons: 'Cancel' and 'Fax'.

6. Do one of the following to choose your recipient:
 - Select a name or group from the **Recipient List**.
 - Enter a name, company, and fax number and click the **+** button.
 - Click the  icon and select a recipient from your address book.
7. Select **Fax Settings** from the pop-up menu.
You see this window:

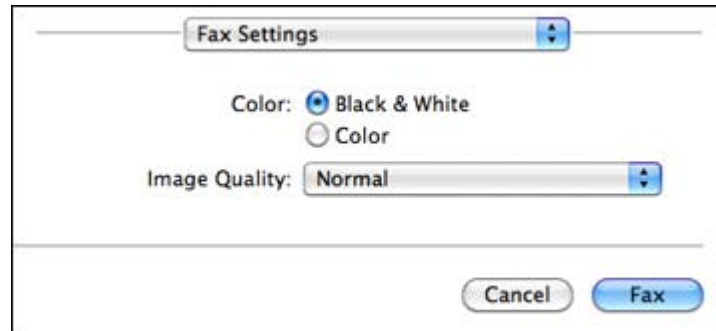

8. Select the **Color** and **Image Quality** settings you want to use for your fax.

9. Click **Fax**.

Parent topic: [Sending Faxes](#)

Receiving Faxes

See these sections to receive faxes with your product.

[Fax Reception](#)

[Receiving Faxes Automatically \(Auto Answer\)](#)

[Receiving Faxes Manually](#)

Parent topic: [Faxing](#)

Fax Reception

Your product will automatically receive and print faxes when you set fax reception mode to **Auto Answer**.

If you connected a telephone to your product so you can use the same phone line for faxes and voice calls, you can also set your product to receive faxes manually. This allows you to check for a fax tone using the telephone and press a button on your product to receive the fax.

Make sure to load paper in your product and select your fax settings before receiving a fax.

Note: If you run out of paper during fax printing, load more paper and press the button indicated on your product's LCD screen to continue.

Parent topic: [Receiving Faxes](#)

Receiving Faxes Automatically (Auto Answer)

To receive and print faxes automatically, you can turn on **Auto Answer** mode.

Check the  auto answer light on your product to see if **Auto Answer** mode is turned on or not.

To turn **Auto Answer** mode on or off, press the  auto answer button.

If an answering machine is connected, make sure the product's **Rings to Answer** setting is set higher than the number of rings your answering machine is set to answer a call. For example, if the answering machine is set to pick up on the fourth ring, set the product to pick up on the fifth ring or later.

If a telephone is connected, and you use it to answer a call that turns out to be a fax, wait until the product's LCD screen displays a message that a connection has been made before hanging up.

Parent topic: [Receiving Faxes](#)

Receiving Faxes Manually

You can set up your product to receive faxes manually by turning off **Auto Answer** mode. This lets you check for a fax tone on the connected telephone before receiving a fax.

1. When the connected telephone rings, answer the call.

You see this message on your product's LCD screen:



2. If you hear a fax tone, select the **Receive** option.

Note: Leave the answered call active as you receive the fax transmission.

3. Follow the instructions on the screen to receive the fax.
When fax transmission is finished, you see the previous LCD screen.
4. Press the **OK** button to print the fax.
5. Hang up the phone.

Parent topic: [Receiving Faxes](#)

Using Memory Cards With Your Product

Follow the instructions here to work with a memory card inserted into your product.

[Inserting a Memory Card](#)

[Printing from a Memory Card](#)

[Transferring Photos on a Memory Card](#)

[Transferring Photos from a Memory Card to Your Computer](#)

[Setting Up File Sharing for Photo Transfers From Your Computer](#)

[Transferring Photos from a Memory Card to an External Device](#)

Inserting a Memory Card

Insert only one memory card at a time into a memory card slot on your product.

1. Make sure the memory card and the files on it are compatible with your product before inserting the card.
2. Insert your memory card into the correct slot, making sure the card is oriented correctly.

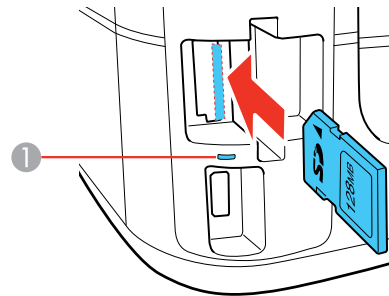

- 1 Memory card access light

Note: Do not force the card all the way into the slot. Insert it only until it meets resistance.

The memory card access light flashes and then stays lit.

Caution: Do not remove a memory card or turn off your product while the memory card access light is flashing or you may lose data from the memory card.

[Memory Card Types](#)

[Memory Card File Specifications](#)

[Removing a Memory Card](#)

Parent topic: [Using Memory Cards With Your Product](#)

Memory Card Types

You can insert these types of memory cards in your product.

Note: Cards marked with an asterisk (*) require an adapter; consult your adapter documentation for details on using it.

Left Slot

You can insert the following cards in the upper slot:

- Memory Stick
- Memory Stick PRO
- Memory Stick Duo*
- Memory Stick PRO Duo*
- Memory Stick PRO-HG Duo*
- Memory Stick Micro*
- MagicGate Memory Stick
- MagicGate Memory Stick Duo*
- SDHC
- SD
- MultiMediaCard
- MMCplus
- MMCmobile*
- MMCmicro*
- miniSDHC*

- miniSD*
- microSDHC*
- microSD*
- xD-Picture Card
- xD-Picture Card Type M
- xD-Picture Card Type M+
- xD-Picture Card Type H

Right Slot

You can insert the following cards in the lower slot:

- CompactFlash
- Microdrive

Parent topic: [Inserting a Memory Card](#)

Memory Card File Specifications

You can insert memory cards in your product containing files that meet these specifications.

File format	JPEG with the Exif version 2.3 standard
Image size	80 × 80 pixels to 9200 × 9200 pixels
Number of files	Up to 9990

Parent topic: [Inserting a Memory Card](#)

Removing a Memory Card

After you finish working with a memory card, you can check to make sure it is safe to remove it from your product.

Caution: Do not remove a memory card or turn off your product while the memory card access light is flashing or you may lose data from the memory card.

1. Make sure the memory card access light is not flashing.

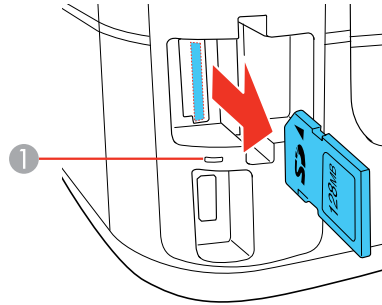

1 Memory card access light

2. If your product is connected to your computer using a USB cable, do one of the following:
 - **Windows:** Open the **My Computer**, **Computer**, or **Windows Explorer** utility. Then right-click the name of your memory card (listed as a removable disk) and select **Eject**.
 - **Mac OS X:** Drag the removable disk icon for your memory card from the desktop into the trash.
3. Pull the memory card straight out of its slot.

Parent topic: [Inserting a Memory Card](#)

Printing from a Memory Card

See these sections to print photos from a memory card inserted into your product:

[Viewing and Printing Photos](#)

[Printing Photo Layouts from a Memory Card](#)

[Printing Photo Greeting Cards](#)

[Printing Photo Proofsheets from a Memory Card](#)

Parent topic: [Using Memory Cards With Your Product](#)

Viewing and Printing Photos

See these sections to view and print photos displayed on your product's LCD screen:

[Viewing and Printing Individual Photos](#)

[Printing All Photos](#)

[Printing Photos by Date](#)

[Viewing and Printing Photos from a Slide Show](#)
[Cropping Photos Displayed on the LCD Screen](#)
[Modifying Photos Displayed on the LCD Screen](#)
[Photo Adjustment Options](#)
[Selecting Print Settings for Photos Displayed on the LCD Screen](#)
[Print Setting Options - Photo Mode](#)

Parent topic: [Printing from a Memory Card](#)

Viewing and Printing Individual Photos

You can select individual photos for printing as you view them on the LCD screen.

1. Press the  home button, if necessary.
2. Select **Print Photos**



3. Select **View and Print Photos**.

You see a screen like this:





4. Press the arrow buttons to scroll through your photos and view the one you want.

Note: To display 9 photos at a time on the LCD screen, press the $\text{9}/\text{9}$ display/crop button three times.

5. Select the photos you want to print and press the + button to select the number of copies you want to print.
6. Do any of the following as necessary:
 - To print more than one copy of the photo, press the + or – button to select the number (up to 99).
 - To crop, zoom into, or rotate your photo, press the $\text{9}/\text{9}$ display/crop button.
 - To view additional photos and select others for printing, press the arrow buttons and repeat the selections above.
7. Press the **OK** button to see a preview of the photos that will print.

You see a screen like this:



8. Do either of the following as necessary:
 - To change any of the print settings displayed on the LCD screen, press the  menu button, select **Print Settings**, and select the necessary settings. When you are finished, press the **OK** button.
 - To modify any of the previewed photos, press the  menu button, select **Photo Adjustments**, and select the necessary settings. When you are finished, press the **OK** button.
9. When you are ready to print, press the  start button.

Note: To cancel printing, select **Cancel**.

Parent topic: [Viewing and Printing Photos](#)

Printing All Photos

You can quickly select all of the photos on your memory card or other device for printing.

1. Press the  home button, if necessary.

2. Select **Print Photos**.



3. Select **Print All Photos**.

You see this screen:



4. Do one of the following:
 - Press the  start button to immediately print one copy of all the photos on Epson photo paper in this size: 4 x 6 inches (102 x 152 mm).
 - To print one copy of all the photos on a different size or type of paper, continue with the next step.



- To print more than one copy of all the photos, press the + or – button to select the number (up to 99).

5. Press the **OK** button.

You see a screen like this:



6. Do either of the following as necessary:

- To change any of the print settings displayed on the LCD screen, press the  menu button, select **Print Settings**, and select the necessary settings. When you are finished, press the **OK** button.
- To modify any of the previewed photos, press the  menu button, select **Photo Adjustments**, and select the necessary settings. When you are finished, press the **OK** button.

7. When you are ready to print, press the  start button.

Note: To cancel printing, select **Cancel**.

Parent topic: [Viewing and Printing Photos](#)

Printing Photos by Date

You can select photos for printing based on the date the photos were taken.

1. Press the  home button, if necessary.

2. Select **Print Photos**.



3. Select **View and Print Photos**.

You see a screen like this:



4. Press the ☰ menu button and select **Select Photos**.

You see this screen:



5. Select the **Select by Date** option.

You see a screen like this:





6. Select any date shown, and press the **OK** button.
7. To print more than one copy of all the photos taken on that date, press the **+** or **-** button to select the number (up to 99). Then press the **OK** button.
8. Press the arrow buttons to scroll through your photos. If necessary, press the **+** or **-** button to adjust the number of individual photos to print.

9. Do any of the following as necessary:
 - To crop, zoom into, or rotate your photo, press the  display/crop button.
10. To see a preview of the photos that will print, press the **OK** button

You see a screen like this:



11. Do either of the following as necessary:
 - To change any of the print settings displayed on the LCD screen, press the  menu button, select **Print Settings**, and select the necessary settings. When you are finished, press the **OK** button.
 - To modify any of the previewed photos, press the  menu button, select **Photo Adjustments**, and select the necessary settings. When you are finished, press the **OK** button.
12. When you are ready to print, press the  start button.

Note: To cancel printing, select **Cancel**.

Parent topic: [Viewing and Printing Photos](#)

Viewing and Printing Photos from a Slide Show

You can view photos one at a time as a slide show on the LCD screen and select the ones you want to print.

1. Press the  home button, if necessary.

2. Select **Print Photos**.



3. Press the arrow buttons and select **Slide Show**.
4. To select a displayed photo for printing, press the **OK** button.
5. Do any of the following as necessary:
 - To print more than one copy of the photo, press the **+** or **-** button to select the number (up to 99).
 - To crop, zoom into, or rotate your photo, press the \square/\square display/crop button.
6. When you are ready to print, press the \blacklozenge start button.

Note: To cancel printing, select **Cancel**.

Parent topic: [Viewing and Printing Photos](#)

Cropping Photos Displayed on the LCD Screen

If you want to crop or rotate photos displayed on the LCD screen, press the \square/\square display/crop button and select the necessary options.

- To crop the photo, press the **+** button to move the yellow crop area inward or the **-** button to move the crop area outward.
- To move the crop area, press the arrow buttons.
- To rotate the image, press the $\blacktriangledown/\equiv$ menu button.
- To check the cropped image, press the **OK** button.

Parent topic: [Viewing and Printing Photos](#)

Modifying Photos Displayed on the LCD Screen

You can modify the quality and appearance of photos displayed on the LCD screen. The modifications affect only the printed copy of the photo, not the original file.

1. Press the  menu button.
2. Select **Photo Adjustments**.

You see this screen:



3. Select a photo adjustment setting.
4. Select an option for the setting.

Note: To clear any previously used settings, press the **C** clear button.

5. When you finish selecting settings, press the **OK** button.

Parent topic: [Viewing and Printing Photos](#)

Photo Adjustment Options

Select the **Photo Adjustment** options you want to use when viewing and printing photos displayed on the LCD screen.

Photo adjustment settings	Available options	Description
Fix Photo	Fix Photo On	Automatically adjusts the brightness, contrast, and saturation of the photo based on the Scene Detection setting that is selected
	Fix Photo Off	Turns off automatic adjustments; see Note below
	P.I.M.	Uses your camera's PRINT Image Matching or Exif Print adjustments
Scene Detection	Automatic	Optimizes the Fix Photo adjustments for specific types of photos; select the option that best matches your photo content
	People	
	Landscape	
	Night Scene	
Fix Red-Eye	Off - This photo	Automatically fixes the red-eye effect in photos
	On - This photo	
	Off - All photos	
	On - All photos	
Filter	Sepia	Applies a sepia tone filter to the viewed or printed photo (does not alter the photo data)
	B&W	Applies a black-and-white filter to the viewed or printed photo (does not alter the photo data)
Brightness	Various settings	Adjust individual qualities in your photo
Contrast		
Saturation		
Sharpness		

Note: **Fix Photo** uses a sophisticated face recognition technology to optimize photos that include faces. For this to work, both eyes and the nose must be visible in the subject's face. If your photo includes a face with an intentional color cast, such as a statue, you may want to turn off **Fix Photo** to retain the special color effects.

Parent topic: [Viewing and Printing Photos](#)

Selecting Print Settings for Photos Displayed on the LCD Screen

You can change the settings used for printing photos displayed on the LCD screen.

1. Press the  menu button.
2. Select **Print Settings**.

You see this screen:



3. Select a print setting.
4. Select an option for the setting.

Note: To clear any previously used settings, press the **C** clear button.

5. When you finish selecting settings, press the **OK** button.

Parent topic: [Viewing and Printing Photos](#)

Print Setting Options - Photo Mode

Select the **Print Settings** you want to use when printing photos displayed on the LCD screen.

Print settings	Available options	Description
Paper Size	Various paper sizes	Indicates the size of paper you have loaded
Paper Type	Various paper types	Indicates the type of paper you have loaded; see the list of paper types for copying (available options depend on the selected Paper Size setting)

Print settings	Available options	Description
Borderless	Off	Expands the image to the edge of the paper (slight cropping may occur)
	On	Leaves a small margin around the image
Quality	Standard Quality	Provides good quality for most prints
Expansion	Standard	Expands images correctly for most borderless prints
	Medium	Expands images slightly less for borderless prints
	Minimum	Expands images the least for borderless prints (you may see some white border)
Date	Various date formats	Prints the date the photo was taken on the photo in the format you select
Fit Frame	On	Automatically crops the photo to fit into the selected photo layout
	Off	Turns off automatic cropping
Bidirectional	On	Prints at normal speed
	Off	Slows down printing to improve print quality

Parent topic: [Viewing and Printing Photos](#)

Printing Photo Layouts from a Memory Card

You can print one or more photos from a memory card in special layouts on various sizes of photo paper.

1. Press the  home button, if necessary.

2. Select **Print Photos**.



3. Press the arrow buttons and select **Photo Layout Sheet**.

You see this screen:



4. Press the arrow buttons to view all of the layout options, then select the option you want.
 5. Select **Paper Size**, then select the size that matches the paper you loaded.
 6. Select **Paper Type**, then select the type that matches the paper you loaded.
- Depending on the layout you selected, you may see this screen:

7. If you see the screen above, do one of the following:
 - To allow your product to place the photos in the layout automatically, select **Automatic layout**.
 - To place photos in the layout manually, select **Place photos manually** and follow the instructions displayed on the screen.
8. Press the arrow buttons to select the photos you want to print.
9. Press the **+** or **-** button to select one or more copies of each photo (up to 99).
10. To select other photos for printing, press the arrow buttons and repeat the selections above, then press the **OK** button.
11. To print more than one copy of the photo layout sheet, press the **+** or **-** buttons to select the number (up to 99), then press the **OK** button.
12. When you are ready to print, press the **◇** start button.

Note: To cancel printing, select **Cancel**.

[Photo Layout Options](#)

Parent topic: [Printing from a Memory Card](#)

Photo Layout Options

Select the layout you want to use when printing your photos in a layout.

2-up, 4-up, 8-up, or 20-up

Print 2, 4, 8, or 20 photos on one sheet.

Upper ½ or Lower ½

Print one photo in the upper or lower half of the sheet.

Photo ID

Prints 4 ID-sized photos on one sheet.

Picture Package

Prints one photo in multiple sizes on one sheet.

Parent topic: [Printing Photo Layouts from a Memory Card](#)

Printing Photo Greeting Cards

You can create custom greeting cards using photos on your memory card or other device, and add your own handwritten or printed text.

First you select your photo and print a template on plain paper. Then you fill out the template, add your message, and print your cards.

[Creating and Printing a Greeting Card Template](#)

[Printing a Greeting Card from a Template](#)

Parent topic: [Printing from a Memory Card](#)

Creating and Printing a Greeting Card Template

Before you start, make sure plain paper is loaded and your memory card is inserted.

1. Press the  home button, if necessary.
2. Select **Print Photos**.



3. Select **Print Photo Greeting Card**.

You see this screen:



4. Select **Select Photo and Print Template**, then press **OK**.
5. Press the arrow buttons to select the photo you want, then press the **OK** button.

You see this screen:



6. Select **Paper Size**, then select **Letter** to print three cards on one letter-size sheet or **4x6in** to print one card.
7. Select **Paper Type**, then select the type of paper you plan to use.
8. Follow the instructions on the LCD screen to select your layout and frame settings.

9. When you are ready to print your greeting card template on plain paper, press the  start button.

Parent topic: [Printing Photo Greeting Cards](#)

Printing a Greeting Card from a Template

After your greeting card template is printed, you fill it out to create your card and add your message.

1. Use a dark pen or pencil to fill in the circles and select the Text Style and Text Effects.

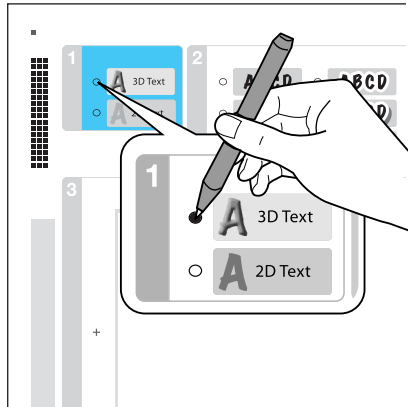

2. Add your greeting card message. You can write it in by hand, print a message and paste it into the box, or draw a picture.

Tip: When adding text, place it in the direction that your photo faces.

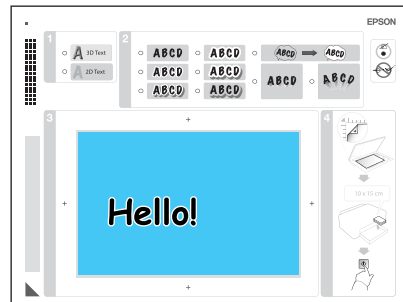

3. Load the type of paper you indicated in the template in the paper cassette.
4. Select **Print Greeting Cards from Template**.
5. Follow the instructions on the LCD screen to place the template facedown on the scanner glass, with the blue triangle facing into the back left corner.
6. Close the document cover.
7. To print more than one copy, press the + or – button to select the number (up to 99).
8. When you are ready to print, press the ⬅ start button.

Note: To cancel printing, select **Cancel**.

When you finish printing, cut your greeting cards apart, if necessary.

Parent topic: [Printing Photo Greeting Cards](#)

Printing Photo Proofsheets from a Memory Card

You can print a proof sheet containing small versions of all the photos on your memory card.



1. Press the 🏠 home button, if necessary.
2. Select **Print Photos**.



3. Press the arrow buttons and select **Print Proof Sheet**.

You see this screen:



4. To change any of the print settings displayed on the LCD screen, press the  menu button, select **Print Settings**, and select the necessary settings. Then press the **OK** button.
5. When you are ready to print, press the  start button.

Note: To cancel printing, select **Cancel**.

Parent topic: [Printing from a Memory Card](#)

Transferring Photos on a Memory Card

You can transfer photos to and from a memory card inserted into your product's memory card slots.

Parent topic: [Using Memory Cards With Your Product](#)

Transferring Photos from a Memory Card to Your Computer

You can transfer photos to and from a memory card inserted into a memory card slot on your product and a computer connected to your product.

Note: Do not transfer photos to and from a memory card while you are printing from the memory card.

1. Make sure your product is connected to a computer.
2. Insert a memory card into a memory card slot on your product.

3. Do one of the following to access your memory card files from your computer:
 - **Windows:** Select the **Computer** or **My Computer** utility, then select the removable disk icon.
 - **Mac OS X with a USB connection:** Look for the removable disk icon on your desktop, then select it.
 - **Mac OS X 10.5/10.6/10.7 with a network connection:** Select the hard drive icon on your desktop or select **Computer** from the **Go** menu, select your product in the **SHARED** section of the sidebar (you may need to widen the sidebar to see the name), then select the **MEMORYCARD** icon.
 - **Mac OS X 10.4 with a network connection:** Select the hard drive icon on your desktop, select **Network** in the sidebar, then select your product (it may be located within a folder with your network's name) and click **OK**. Select the **MEMORYCARD** icon on your desktop.
4. Select the folder that contains your photos.
5. Drag the photos you want to transfer to the desired folder on your computer or on your memory card.

Note: Your product's LCD screen does not update to display new photos transferred to the memory card. Wait until the memory card access light stops flashing, then remove and insert the memory card to update the photos displayed.

Parent topic: [Using Memory Cards With Your Product](#)

Setting Up File Sharing for Photo Transfers From Your Computer

Before you transfer photos from a computer to a memory card inserted into your product's memory card slots, you may need to set up your product's file sharing settings.

Caution: Remove the memory card before you change this setting or you may lose data from the memory card. Do not remove a memory card or turn off your product while the memory card access light is flashing or you may lose data from the memory card.

1. Press the **Setup** button.
2. Press the arrow buttons to select **File Sharing Setup** and press the **OK** button.
3. Press the arrow buttons to select your connection type and press the **OK** button.

Parent topic: [Using Memory Cards With Your Product](#)

Transferring Photos from a Memory Card to an External Device

You can back up photos from your memory card to an external storage device connected to the product, such as a USB flash drive, external hard drive, or external CD or DVD burner.

Note: Epson cannot guarantee the compatibility of your storage device.

1. Insert a memory card in one of the memory card slots.
2. Insert your USB flash drive or the USB cable for your external drive into the  USB port on the front of your product.

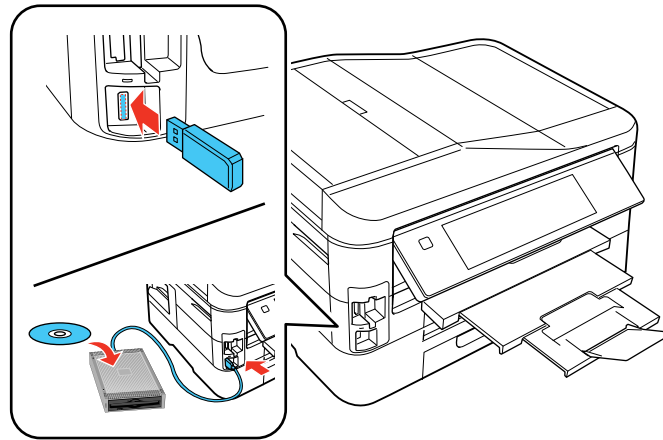

3. Insert storage media (such as a CD) into your drive, if necessary.
4. Press the  home button, if necessary.

5. Press the arrow buttons and then select **Back Up Data**.



6. Select **Back Up Memory Card**.

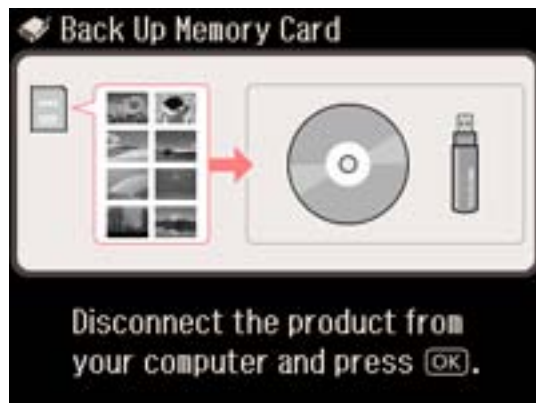

7. Follow the instructions on the screen to disconnect the product from your computer and begin copying files to the external device.
8. When the backup is finished, you can remove your memory card and disconnect the external device. The files are saved in folders numbered for each backup session.

Parent topic: [Using Memory Cards With Your Product](#)

Using an External Device with Your Product

Follow the instructions in these sections to use your product with an external device, such as a camera, smartphone, or other device.

[Wireless Printing from a Mobile Device](#)

[Printing from a Camera Connected to Your Product](#)

[Viewing or Printing from a USB Flash Drive or External Device](#)

[Charging a USB Device Using Your Product](#)

Wireless Printing from a Mobile Device

You can print photos, documents, web pages, and more from smartphones or tablets, such as iPhones, iPads, and Android devices.

1. Set up your product for wireless printing as described on the *Start Here* sheet.
2. Visit www.epson.com/connect to learn more about mobile device printing and check the compatibility of your mobile device.
3. Connect your mobile device to the same wireless network that your product is using.
4. Print from your mobile device to your EPSON product.

Parent topic: [Using an External Device with Your Product](#)

Printing from a Camera Connected to Your Product

If you have a digital camera that supports PictBridge printing, you can connect it to the product and print your photos directly from the camera. Check your camera manual to see if it is compatible.

Note: Your photos must be in JPG format and sized from 80 × 80 to 9200 × 9200 pixels. Epson cannot guarantee the compatibility of your camera. Some combinations of paper type, size, and layout may not be supported, depending on your camera and the product settings.

[Connecting and Printing From a Camera](#)

[Selecting Print Settings for Printing From a Camera](#)

Parent topic: [Using an External Device with Your Product](#)

Connecting and Printing From a Camera

Before you connect your camera, make sure the product is turned on but not printing.

1. Remove any memory cards from the product.
2. Load the paper you want to use for printing.
3. Connect the USB cable that came with your camera to the  USB port on the front of your product.

Note: You cannot use the USB port to transfer images from your camera to your computer.

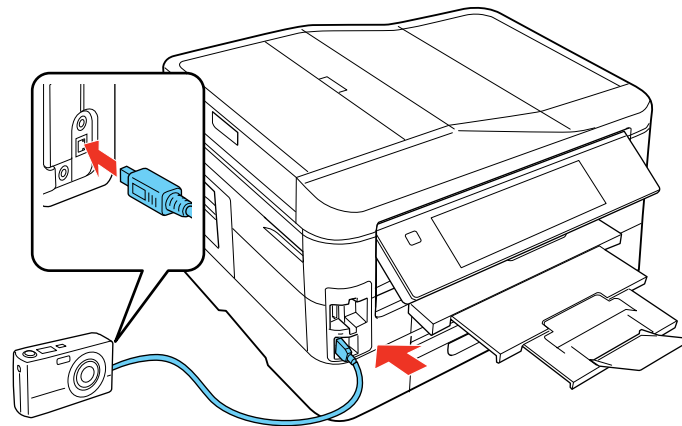

4. Turn on your camera.
You see this screen:

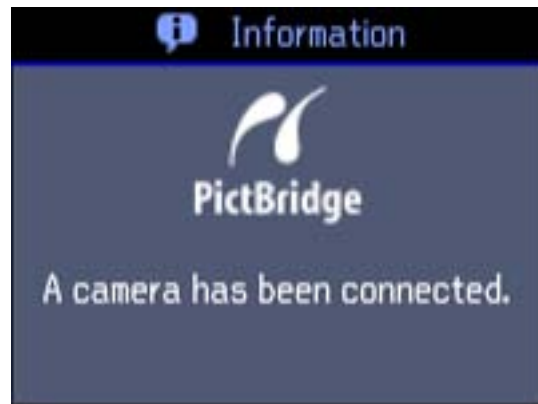

5. Follow the instructions that came with your camera to select and print your photos.
When you finish printing, turn off your camera and disconnect it from the product.

Parent topic: [Printing from a Camera Connected to Your Product](#)

Selecting Print Settings for Printing From a Camera

Before printing from your camera, you can select the print settings you will use for printing your photos.

1. Press the  home button, if necessary.
2. Select **Setup**.

You see this screen:



3. Press the arrow buttons and select **External Device Setup**.
4. Select **Print Settings**.

You see this screen:



5. Select the print settings you want to use, then press the **OK** button.
6. Select **Photo Adjustments**.

You see this screen:



7. Select the photo adjustments you want to use, then press the **OK** button to exit.
- After you select settings, you are ready to connect your camera and print your photos.

[Print Settings - Camera](#)

[Photo Adjustments - Camera](#)

Parent topic: [Printing from a Camera Connected to Your Product](#)

Print Settings - Camera

Select the **Print Settings** options you want to use when printing photos from your camera.

Print settings	Available options	Description
Paper Size	Various paper sizes	Indicates the size of paper you have loaded
Paper Type	Various paper types	Indicates the type of paper you have loaded; see the list of paper types for copying (available options depend on the selected Paper Size setting)
Layout	Borderless	Expands the image to the edge of the paper (slight cropping may occur)
	With Border	Leaves a small margin around the image
	2-up, 4-up, 8-up, or 20-up	Print 2, 4, 8, or 20 photos on one sheet
	Upper ½ or Lower ½	Print one photo in the upper or lower half of the sheet
	Photo ID	Prints 4 ID-sized photos on one sheet
Quality	Standard Quality	Provides good quality for most prints
Expansion	Standard	Expands images correctly for most borderless prints
	Medium	Expands images slightly less for borderless prints
	Minimum	Expands images the least for borderless prints (you may see some white border)
Date	On/Off	Prints the date the photo was taken on the photo
Fit Frame	On	Automatically crops the photo to fit into the selected photo layout
	Off	Turns off automatic cropping
Bidirectional	On	Prints at normal speed
	Off	Slows down printing to improve print quality

Parent topic: [Selecting Print Settings for Printing From a Camera](#)

Photo Adjustments - Camera

Select the **Photo Adjustments** options you want to use when printing photos from your camera.

Photo adjustment settings	Available options	Description
Fix Photo	Fix Photo On	Automatically adjusts the brightness, contrast, and saturation of the photo based on the Scene Detection setting that is selected
	Fix Photo Off	Turns off automatic adjustments; see Note below
	P.I.M	Uses your camera's PRINT Image Matching or Exif Print adjustments
Scene Detection	Automatic	Optimizes the Fix Photo adjustments for specific types of photos; select the option that best matches your photo content
	People	
	Landscape	
	Night Scene	
Fix Red-Eye	On/Off	Automatically fixes the red-eye effect in photos
Filter	Sepia	Applies a sepia tone filter to the viewed or printed photo (does not alter the photo data)
	B&W	Applies a black-and-white filter to the viewed or printed photo (does not alter the photo data)
Brightness	Various settings	Adjust individual qualities in your photo
Contrast		
Sharpness		
Saturation		

Note: **Fix Photo** uses a sophisticated face recognition technology to optimize photos that include faces. For this to work, both eyes and the nose must be visible in the subject's face. If your photo includes a face with an intentional color cast, such as a statue, you may want to turn off **Fix Photo** to retain the special color effects.

Parent topic: [Selecting Print Settings for Printing From a Camera](#)

Viewing or Printing from a USB Flash Drive or External Device

You can view and print photos from a USB thumb drive or other external storage device, such as an external hard drive or CD/DVD burner.

Note: Make sure the files on your device are compatible with the product.

[USB Device File Specifications](#)

[Connecting and Using a USB Flash Drive or External Device](#)

Parent topic: [Using an External Device with Your Product](#)

USB Device File Specifications

You can print external device files that meet these specifications.

File format	JPEG with the Exif version 2.3 standard
Image size	80 × 80 pixels to 9200 × 9200 pixels
Number of files	Up to 9990

Parent topic: [Viewing or Printing from a USB Flash Drive or External Device](#)

Connecting and Using a USB Flash Drive or External Device

Before you connect your thumb drive or device, make sure the product is turned on but not printing.

Note: Epson cannot guarantee the compatibility of your drive.

1. Remove any memory cards from the product.
2. Load the paper you want to use for printing.
3. Insert your USB thumb drive or the USB cable that came with your device into the  USB port on the front of your product.

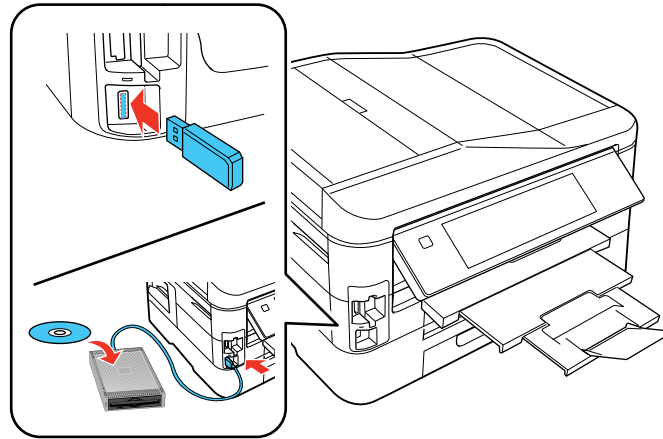

4. Insert storage media (such as a CD) into your drive, if necessary.
5. If there are folders on your storage media, select the folder you want and press the **OK** button.

You can view and print your photos from the LCD screen.

When you finish printing, make sure the access light on the drive is not flashing, then remove or disconnect it from the product.

Caution: Do not remove the USB drive or turn off the product when the access light is flashing, or you may lose photos on the drive.

Parent topic: [Viewing or Printing from a USB Flash Drive or External Device](#)

Related references

[External USB Device Specifications](#)

Charging a USB Device Using Your Product

You can charge your cell phone, music player, or other portable device by connecting it to the product. All you need is a user-supplied USB cable that is designed to work with your device.

Caution: Make sure your portable device complies with USB 2.0 standards. Devices that draw more than 500 mA may damage your EPSON product. Epson cannot guarantee the compatibility of your device. Contact the device manufacturer for more information.

1. Turn on your product.
2. Connect your portable device to the  USB port on the front of the product.

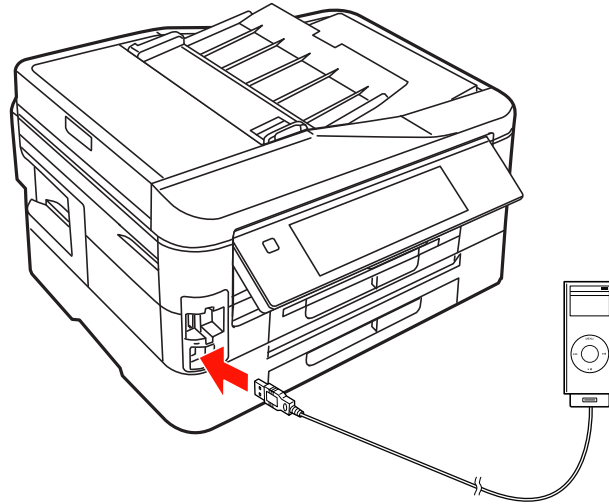

3. Leave your product on while charging (it will continue to charge even after going into sleep mode).

Note: You cannot use the USB port to transfer images from your device to your computer. If you want to transfer images, use the memory card slots instead. Disconnect your portable device before inserting a memory card.

Parent topic: [Using an External Device with Your Product](#)

Printing Personalized Projects

You can print lined paper, graph paper, or stationery with a photo background.

[Printing Personalized Note Paper](#)

[Printing Lined Paper and Graph Paper](#)

Printing Personalized Note Paper

You can print lined or unlined note paper with one of your own photos in the background.

1. Load plain paper in either Letter (8.5 × 11 inches [216 × 279 mm]) or A4 (8.3 × 11.7 inches [210 × 297 mm]) size.
2. Insert a memory card into your product's memory card slot.
3. Press the  home button, if necessary.
4. Select **Print Ruled Paper**.
5. Press the arrow buttons and select one of the note paper options (with or without lines) for the size paper you loaded.

You see this screen:



6. Press the **OK** button.

You see a preview of your note paper with a photo in the background.

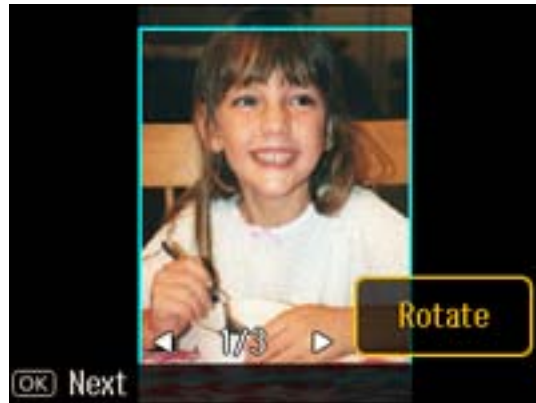

7. Press the arrow buttons to scroll through your photos and display the one you want to use for your note paper.
8. To rotate the layout, select **Rotate**, then press the **OK** button.
9. When you see a message asking you to load paper, press the **OK** button.
10. To print more than one sheet, press the **+** or **-** button to select the number (up to 99).
11. When you are ready to print, press the **◇** start button.

Note: To cancel printing, select **Cancel**.

Parent topic: [Printing Personalized Projects](#)

Printing Lined Paper and Graph Paper

You can print wide-rule or narrow-rule notebook paper and graph paper.

1. Load plain paper in either Letter (8.5 × 11 inches [216 × 279 mm]) or A4 (8.3 × 11.7 inches [210 × 297 mm]) size.
2. Press the **Print Ruled Paper** button.

You see this screen:



3. Press the arrow buttons and select one of the following in either **Letter** or **A4** size:
 - **Wide Rule**
 - **Thin Rule**
 - **Grph Paper**
4. When you see a message asking you to load paper, press the **OK** button.
5. To print more than one sheet, press the **+** or **-** button to select the number (up to 99).
6. When you are ready to print, press the **◇** start button.

Note: To cancel printing, select **Cancel**.

Parent topic: [Printing Personalized Projects](#)

Replacing Ink Cartridges

When an ink cartridge is expended, you need to replace it.

You may also need to replace a cartridge that is more than six months old, if your printouts do not look their best, even after cleaning and aligning the print head.

Note: Please dispose of your used EPSON branded ink cartridges responsibly and in accordance with local requirements. If you would like to return your used ink cartridges to Epson for proper disposal, please go to www.epson.com/recycle for more information.

[Check Cartridge Status](#)

[Purchase EPSON Ink Cartridges](#)

[Removing and Installing Ink Cartridges](#)

[Printing With Black Ink and Expended Color Cartridges](#)

[Conserving Low Black Ink with Windows](#)

Check Cartridge Status

Your product and its printing software will let you know when an ink cartridge is low or expended.

[Checking Cartridge Status on the LCD Screen](#)

[Checking Cartridge Status with Windows](#)

[Checking Cartridge Status with Mac OS X](#)

Parent topic: [Replacing Ink Cartridges](#)

Checking Cartridge Status on the LCD Screen

You can check the status of your ink cartridges using your product's LCD screen.

1. Press the  home button, if necessary.
2. Press the **Setup** button.
3. Select **Ink Levels**.

You see a screen like this:

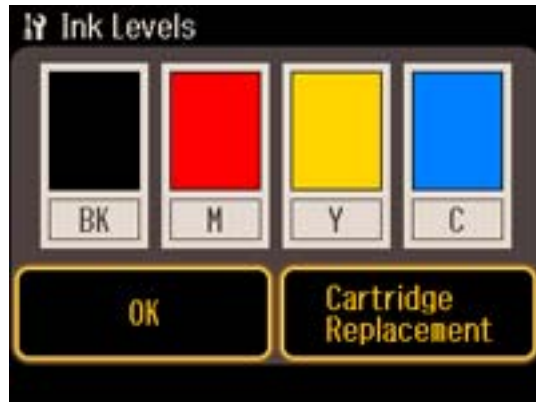

Note: The display is different depending on which ink cartridges are low or expended, if any. Displayed ink levels are approximate.

4. Do one of the following:
 - To exit, select **OK**
 - If you need to replace an ink cartridge, select **Cartridge Replacement** and follow the instructions on the screen

Parent topic: [Check Cartridge Status](#)

Checking Cartridge Status with Windows

A low ink reminder appears if you try to print when ink is low, and you can check your cartridge status at any time using a utility on your Windows computer.

1. To check your cartridge status, double-click the product icon in the Windows taskbar, then click the **Details** button in the window that appears.

You see this window:

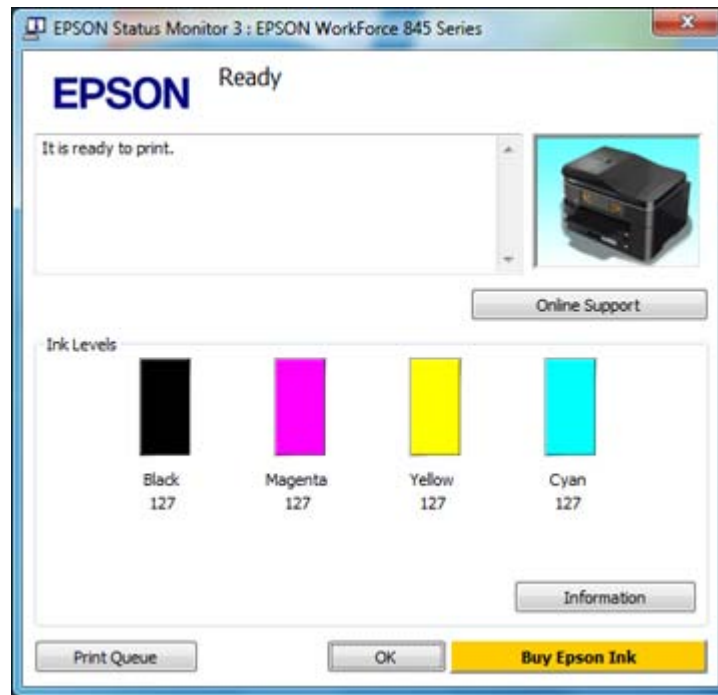

2. Replace or reinstall any ink cartridge indicated on the screen.

Note: Depending on the color of the expended cartridge and how you are printing, you may be able to continue printing temporarily.

Note: If any of the cartridges installed in the product is broken, incompatible with the product model, or improperly installed, EPSON Status Monitor will not display an accurate cartridge status.

3. To disable the low ink reminder, right-click the product icon in the Windows taskbar and select **Monitoring Preferences**.

You see this window:

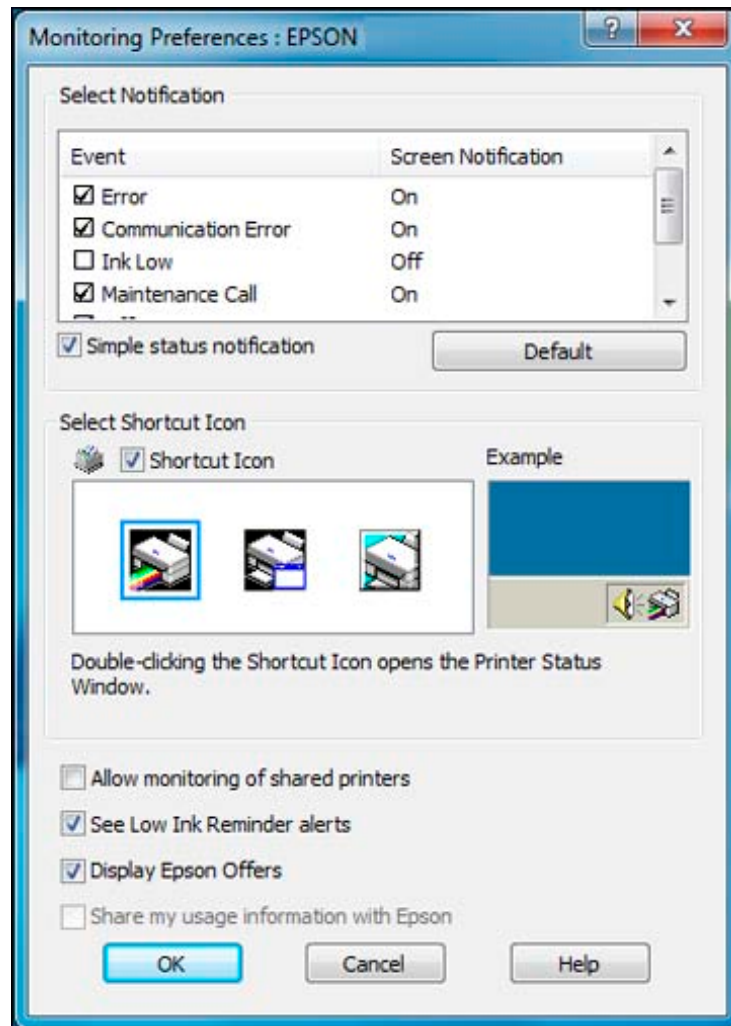

4. Deselect the **See Low Ink Reminder alerts** checkbox at the bottom of the screen.
5. To disable promotional offers, deselect the **Display Epson Offers** checkbox.

Parent topic: [Check Cartridge Status](#)

Related tasks

[Checking the Nozzles Using the Product Control Panel](#)

Checking Cartridge Status with Mac OS X

You can check the status of your ink cartridges using a utility on your Mac.

1. Do one of the following:
 - **Mac OS X 10.6/10.7:** In the Apple menu or the Dock, select **System Preferences**. Select **Print & Fax** or **Print & Scan**, select your product, and select **Options & Supplies**. Select **Utility** and select **Open Printer Utility**.
 - **Mac OS X 10.4/10.5:** In the Apple menu or the Dock, select **System Preferences**. Select **Print & Fax**, select your product, and select **Open Print Queue** or **Print Queue**. Select **Utility**.
2. Select **EPSON Status Monitor**.

You see this window:



3. Do the following as necessary:
 - You can update the ink cartridge status by clicking **Update**.
 - Replace or reinstall any ink cartridge indicated on the screen.

Note: If any of the cartridges installed in the product is broken, incompatible with the product model, or improperly installed, EPSON Status Monitor will not display an accurate cartridge status.

Parent topic: [Check Cartridge Status](#)

Purchase EPSON Ink Cartridges

You can purchase genuine EPSON ink and paper at EPSON Supplies Central at www.epson.com/ink3 (U.S. sales) or www.epson.ca (Canadian sales). You can also purchase supplies from an EPSON authorized reseller. To find the nearest one, call 800-GO-EPSON (800-463-7766).

Note: We recommend that you use genuine EPSON cartridges and do not refill them. The use of other products may affect your print quality and could result in printer damage.

The printer ships with full cartridges and part of the ink from this first set of cartridges is used for priming the printer. Yields vary considerably based on images printed, print settings, paper type, frequency of use, and temperature. For print quality, a variable amount of ink remains in the cartridge after the "replace cartridge" indicator comes on.

[Ink Cartridge Part Numbers](#)

Parent topic: [Replacing Ink Cartridges](#)

Ink Cartridge Part Numbers

Use these part numbers when you order or purchase new ink cartridges, and use the cartridges within six months of installing them.

Ink color	Part number	
	High-capacity	Extra High-capacity
Black	126	127
Cyan	126	127
Magenta	126	127
Yellow	126	127

Parent topic: [Purchase EPSON Ink Cartridges](#)

Removing and Installing Ink Cartridges

Make sure you have your replacement cartridges handy before you begin. You must install new cartridges immediately after removing the old ones.

Caution: Leave your old cartridges in the printer until you are ready to replace them to prevent the print head nozzles from drying out. Do not open ink cartridge packages until you are ready to install the ink. Cartridges are vacuum packed to maintain reliability.

1. Turn on your product.
 - If an ink cartridge is expended, you see a message on the LCD screen. Note which cartridges need to be replaced and press the **OK** button, then choose **Replace now**.
 - If you are replacing a cartridge before you see a message on the LCD screen, press the **Home** button, select **Setup**, press the arrow buttons and select **Maintenance**, then select **Ink Cartridge Replacement**.
2. Lift up the scanner unit.

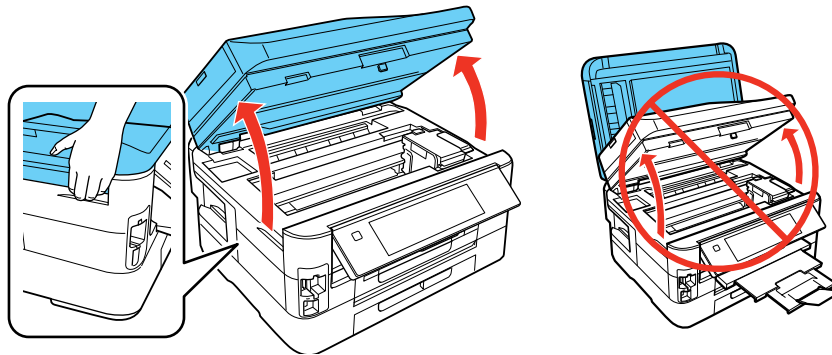

3. Open the cartridge cover.

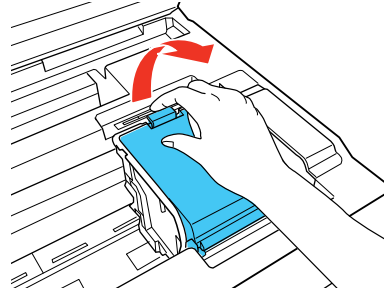

4. Squeeze the tab on the cartridge and lift the cartridge straight up to remove it.

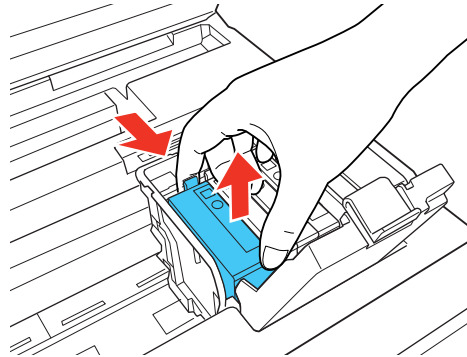

Note: Dispose of used cartridges carefully. Do not take the used cartridge apart or try to refill it.

Warning: If ink gets on your skin, wash it thoroughly with soap and water. If ink gets into your eyes, flush them immediately with water. If ink gets into your mouth, spit it out and see a doctor right away. Keep ink cartridges out of the reach of children.

5. Before opening the new cartridge package, shake it gently four or five times.

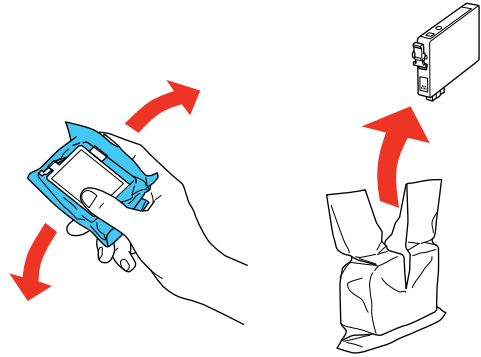

Caution: Do not shake the cartridges after opening the packages, or ink may leak.

6. Remove the cartridge from the package.

Caution: Do not touch the green chip on the cartridge. Install the new cartridge immediately after removing the old one; if you do not, the print head may dry out and be unable to print.

7. Remove the yellow tape from the bottom of the cartridge.

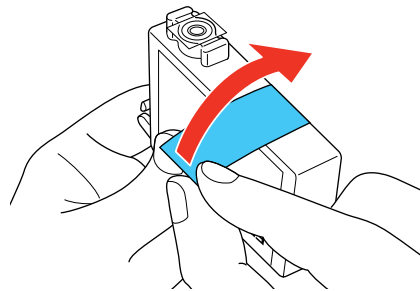

Caution: Do not remove any other labels or seals, or ink will leak.

8. Insert the new cartridge into the holder and push it down until it clicks into place.

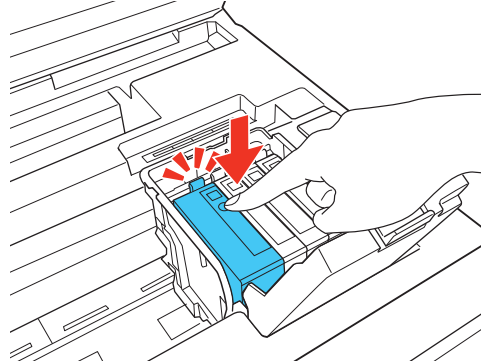

9. Close the cartridge cover and push it down until it clicks into place.

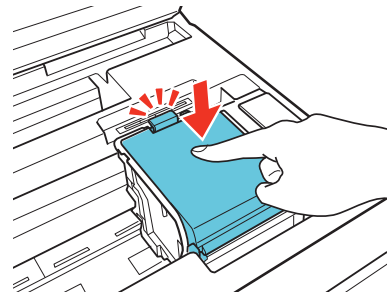

10. Lower the scanner unit.

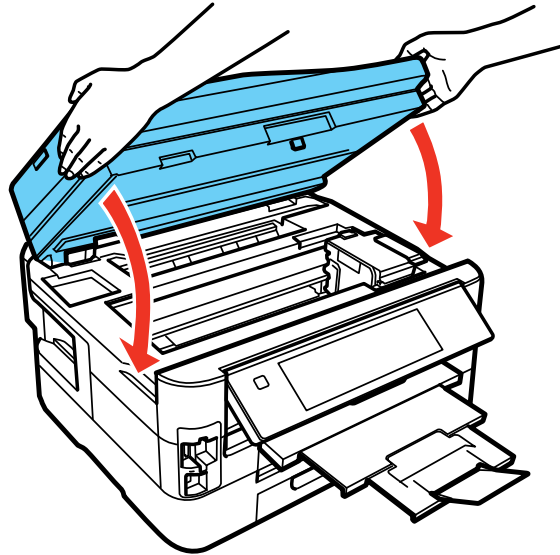

The print head moves to its home position and the printer starts charging the ink. This takes about 2.5 minutes. When you see a confirmation message on the screen, ink charging is finished.

Caution: Never turn off the product while the power light is flashing or you will waste ink.

If you see an error screen telling you an ink cartridge is installed incorrectly, lift up the scanner unit and press the ink cartridge down until it clicks into place. When you're finished, press the **OK** button.

If you remove a low or expended ink cartridge, you cannot re-install and use the cartridge.

Caution: If you remove an ink cartridge for later use, protect the ink supply area from dirt and dust and store it in the same environment as the printer. The valve in the ink supply port is designed to contain any excess ink, but do not touch the ink supply port or surrounding area. Always store ink cartridges with the label facing up; do not store cartridges upside-down.

Parent topic: [Replacing Ink Cartridges](#)

Related concepts

[Purchase EPSON Ink Cartridges](#)

Printing With Black Ink and Expended Color Cartridges

When a color ink cartridge is expended, you can temporarily continue printing from your computer using black ink. Replace the expended color cartridge as soon as possible for future printing.

Note: You cannot print with expended color ink cartridges using your product's control panel.

[Printing With Expended Color Cartridges - Windows](#)

[Printing With Expended Color Cartridges - Mac OS X 10.5/10.6/10.7](#)

Parent topic: [Replacing Ink Cartridges](#)

Printing With Expended Color Cartridges - Windows

If you see a message during printing telling you that you can temporarily print in black ink with an expended color cartridge, you can cancel your print job and select settings to print on plain paper or on an envelope.

1. Click **Stop** or **Cancel Print** to cancel your print job.

Note: If the message screen appears on another computer on a network, you may need to cancel the print job using the product control panel.

2. Load plain paper or an envelope in your product.
3. Access the print settings in your print application.
4. Click the **Main** tab.
5. Select **Plain Paper/Bright White Paper** or **Envelope** as the paper type setting.
6. Select the **Black/Grayscale** checkbox.
7. Click **OK**.
8. Print your document.
EPSON Status Monitor 3 displays a print message.
9. Click **Print in Black** to print your document.

Parent topic: [Printing With Black Ink and Expended Color Cartridges](#)

Printing With Expended Color Cartridges - Mac OS X 10.5/10.6/10.7

If printing stops, you can cancel your print job and select settings to temporarily print with only black ink on plain paper or on an envelope.

1. Click the printer icon in the Dock.
2. If you see a message telling you that you can temporarily print with only black ink, click the **Delete** icon to cancel your print job.

Note: If the message screen appears on another computer on a network, you may need to cancel the print job using the product control panel.

3. Do one of the following:
 - **Mac OS X 10.6/10.7:** In the Apple menu or the Dock, select **System Preferences**. Select **Print & Fax** or **Print & Scan**, select your product, and select **Options & Supplies**. Select **Utility** and select **Open Printer Utility**.
 - **Mac OS X 10.5:** In the Apple menu or the Dock, select **System Preferences**. Select **Print & Fax**, select your product, and select **Open Print Queue**. Select **Utility**.
4. Select **Monitoring Preferences**.
5. Make sure the **Permit temporary black printing** checkbox is selected.
6. Close the utility window.
7. Load plain paper or an envelope in your product.
8. Access the print settings in your print application.
9. Select **Print Settings** from the pop-up menu.
10. Select **Plain Paper/Bright White Paper** or **Envelope** as the paper type setting.
11. Select the **Grayscale** option.
12. Click **Print** to print your document.

Parent topic: [Printing With Black Ink and Expended Color Cartridges](#)

Conserving Low Black Ink with Windows

The following window appears when black ink runs low and there is more color ink.

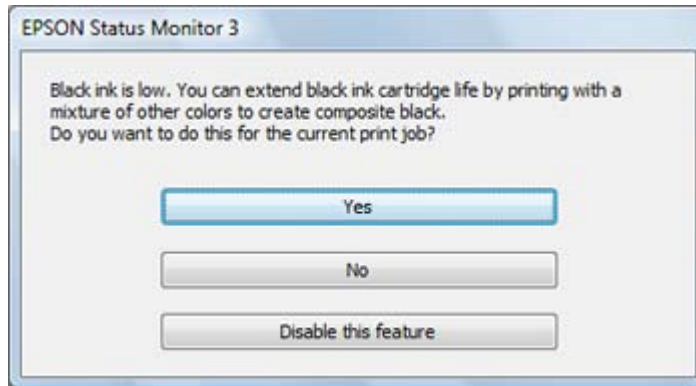

Note: The window appears only when you have selected **Plain Paper/Bright White Paper** as the paper type setting, and depends on other selected print settings.

- Click **Yes** to use a mixture of color inks to create black, or **No** to continue using the remaining black ink for the document you are printing.
- Click **Disable this feature** to continue using the remaining black ink.

Note: If you disable this feature, it remains disabled unless you reinstall the printer software.

Parent topic: [Replacing Ink Cartridges](#)

Adjusting Print Quality

If your print quality declines, you may need to run a utility to clean or align the print head.

If running these utilities does not solve the problem, you may need to replace the ink cartridges.

[Print Head Maintenance](#)

[Cleaning the Paper Path](#)

Print Head Maintenance

If your printouts become too light, or you see dark or light bands across them, you may need to clean the print head nozzles. Cleaning uses ink, so clean the nozzles only if print quality declines.

You can check for clogged nozzles before you clean them so you don't clean them unnecessarily.

Note: You cannot clean the print head if an ink cartridge is expended, and may not be able to clean it when a cartridge is low. You must replace the cartridge first.

[Print Head Nozzle Check](#)

[Print Head Cleaning](#)

[Print Head Alignment](#)

Parent topic: [Adjusting Print Quality](#)

Related topics

[Replacing Ink Cartridges](#)

Print Head Nozzle Check

You can print a nozzle check pattern to check for clogged nozzles.

[Checking the Nozzles Using the Product Control Panel](#)

[Checking the Nozzles Using a Computer Utility](#)

Parent topic: [Print Head Maintenance](#)

Checking the Nozzles Using the Product Control Panel

You can check the print head nozzles using the control panel on your product.

1. Make sure plain paper is loaded in the product.
2. Press the  home button, if necessary.

3. Select **Setup**.
4. Select **Maintenance**.

You see this screen:



5. Select **Nozzle Check**.

You see this screen:

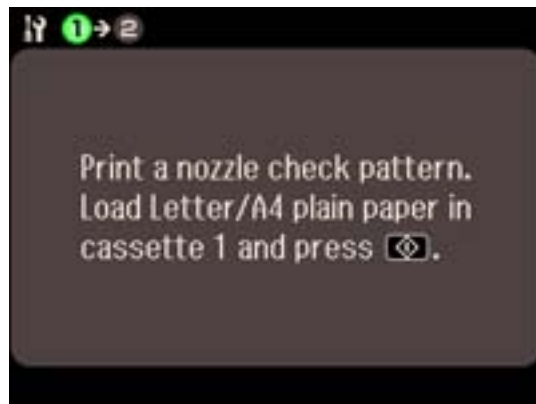

6. Press the  start button.

After the nozzle pattern prints, you see this screen:

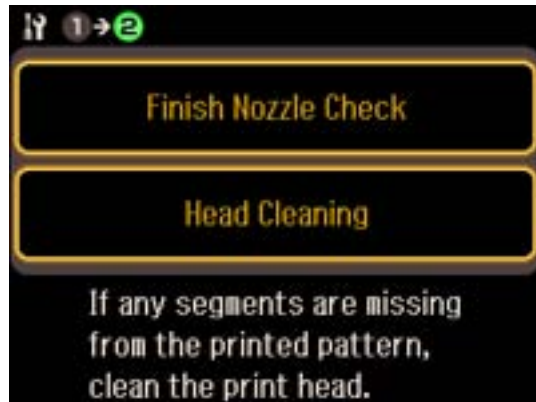

7. Check the printed pattern to see if there are gaps in the lines.

Print head is clean

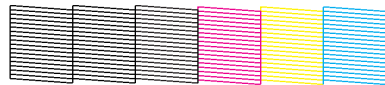

Print head needs cleaning

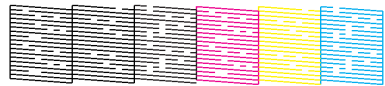

8. Do one of the following:
 - If there are no gaps, select **Finish Nozzle Check**.
 - If there are gaps or the pattern is faint, select **Head Cleaning** and continue.
9. Follow the instructions on the screen to clean the print head, check the nozzles, and repeat the process as necessary.

If you don't see any improvement after cleaning the print head up to 4 times, wait at least 6 hours. Then try cleaning the print head again. If quality still does not improve, one of the ink cartridges may be old or damaged and needs to be replaced.

Parent topic: [Print Head Nozzle Check](#)

Checking the Nozzles Using a Computer Utility

You can check the print head nozzles using a utility on your Windows or Mac computer.

1. Load a few sheets of plain paper in the product.
2. Do one of the following:
 - **Windows:** Right-click the product icon in the Windows taskbar.
 - **Mac OS X 10.6/10.7:** In the Apple menu or the Dock, select **System Preferences**. Select **Print & Fax** or **Print & Scan**, select your product, and select **Options & Supplies**. Select **Utility** and select **Open Printer Utility**.
 - **Mac OS X 10.4/10.5:** In the Apple menu or the Dock, select **System Preferences**. Select **Print & Fax**, select your product, and select **Open Print Queue** or **Print Queue**. Select **Utility**.
3. Select **Nozzle Check**.

You see one of these windows:

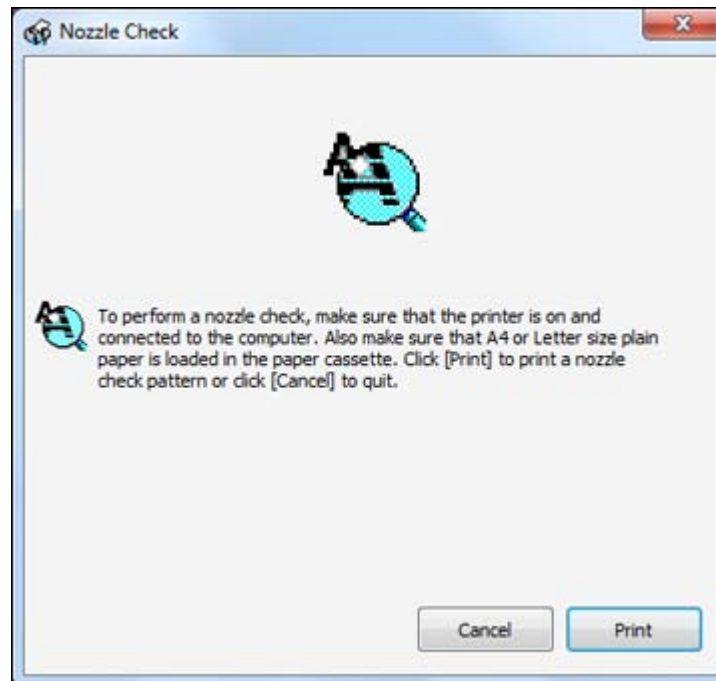

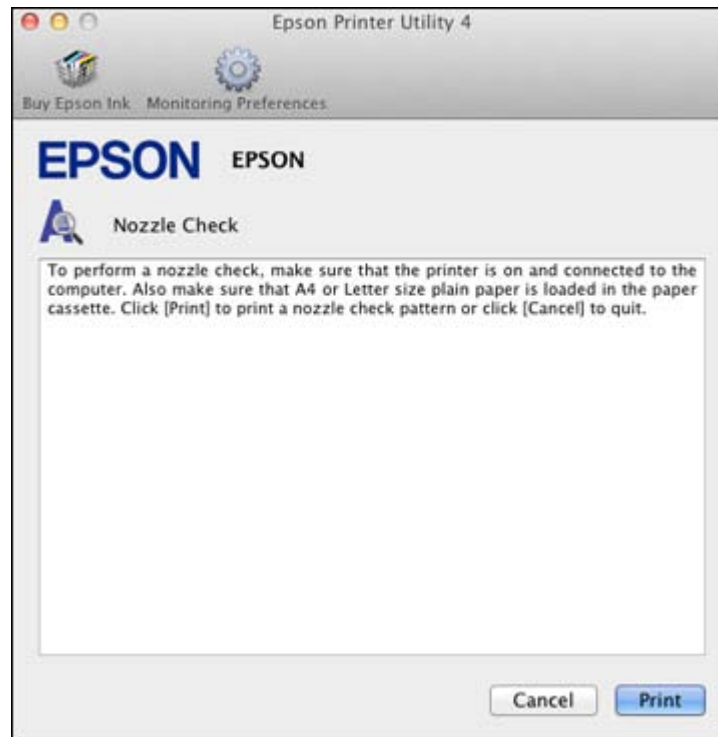

4. Click **Print**.
5. Check the printed pattern to see if there are gaps in the lines.

Print head is clean

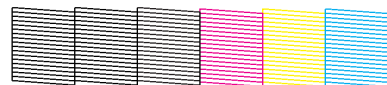

Print head needs cleaning

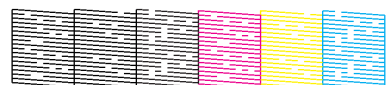

6. If there are no gaps, click **Finish**.

If there are gaps or the pattern is faint, clean the print head.

Parent topic: [Print Head Nozzle Check](#)

Related concepts

[Print Head Cleaning](#)

Print Head Cleaning

If print quality has declined and the nozzle check pattern indicates clogged nozzles, you can clean the print head.

Note: You cannot clean the print head if an ink cartridge is expended, and may not be able to clean it when a cartridge is low. You must replace the cartridge first.

[Cleaning the Print Head Using the Product Control Panel](#)

[Cleaning the Print Head Using a Computer Utility](#)

Parent topic: [Print Head Maintenance](#)

Related topics

[Replacing Ink Cartridges](#)

Cleaning the Print Head Using the Product Control Panel

You can clean the print head using the control panel on your product.

1. Make sure plain paper is loaded in the product.
2. Press the  home button, if necessary.
3. Select **Setup**.
4. Select **Maintenance**.

You see this screen:



5. Select **Head Cleaning**.

You see this screen:

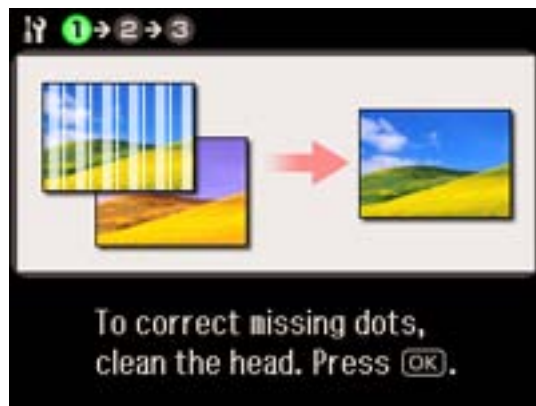

6. Press the **OK** button.
7. Select the cleaning cycle you want to run.

When the cleaning cycle is finished, you see this screen:

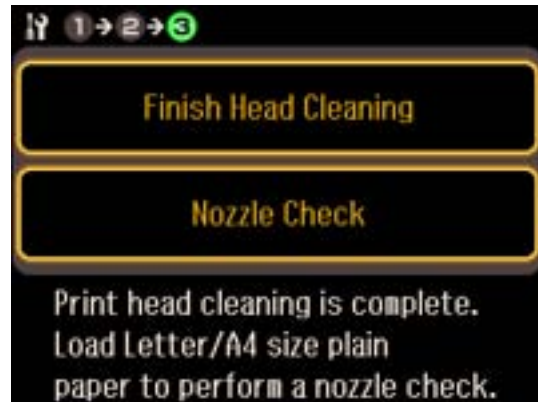

Caution: Never turn off the product during a cleaning cycle or you may damage it.

8. Select **Nozzle Check**.
9. Press the \diamond start button to confirm that the print head is clean.

If you don't see any improvement after cleaning the print head up to 4 times, wait at least 6 hours. Then try cleaning the print head again. If quality still does not improve, one of the ink cartridges may be old or damaged and needs to be replaced.

Parent topic: [Print Head Cleaning](#)

Related topics

[Replacing Ink Cartridges](#)

Cleaning the Print Head Using a Computer Utility

You can clean the print head using a utility on your Windows computer or Mac.

1. Load a few sheets of plain paper in the product.
2. Do one of the following:
 - **Windows:** Right-click the product icon in the Windows taskbar.
 - **Mac OS X 10.6/10.7:** In the Apple menu or the Dock, select **System Preferences**. Select **Print & Fax** or **Print & Scan**, select your product, and select **Options & Supplies**. Select **Utility** and select **Open Printer Utility**.
 - **Mac OS X 10.4/10.5:** In the Apple menu or the Dock, select **System Preferences**. Select **Print & Fax**, select your product, and select **Open Print Queue** or **Print Queue**. Select **Utility**.

3. Select **Head Cleaning**.

You see one of these windows:



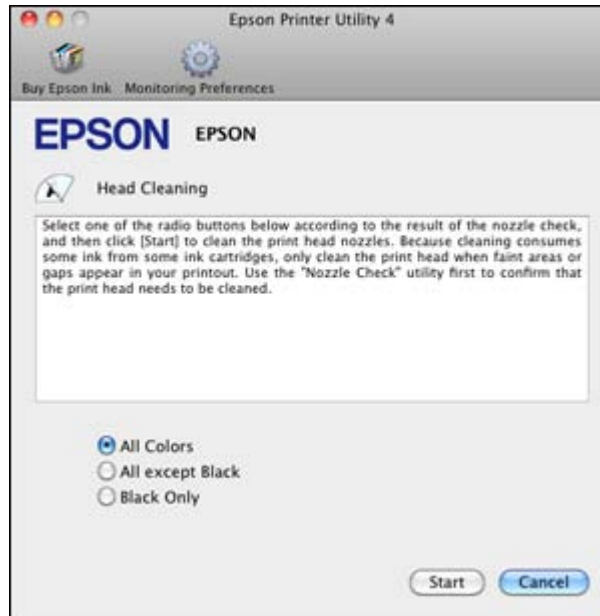

4. Select the cleaning cycle you want to run, based on the nozzle check pattern.
5. Click **Start** to begin the cleaning cycle.

The  power light flashes throughout the cleaning cycle and stays on when the cleaning cycle is finished.

Caution: Never turn off the product during a cleaning cycle or you may damage it.

6. When the  power light stops flashing and remains on, you can check to see if the nozzles are clean; click **Print Nozzle Check Pattern** and click **Print**.
7. Check the printed pattern to see if there are gaps in the lines.

Print head is clean

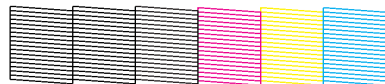

Print head needs cleaning

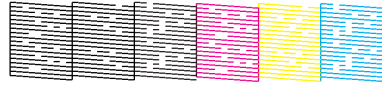

- If there are no gaps, click **Finish**.
- If there are gaps or the pattern is faint, click **Clean** to clean the print head again.

Parent topic: [Print Head Cleaning](#)

Related topics

[Replacing Ink Cartridges](#)

Print Head Alignment

If your printouts become grainy or blurry, you notice misalignment of vertical lines, or you see dark or light horizontal bands, you may need to align the print head.

Note: Banding may also occur if your print head nozzles need cleaning.

[Aligning the Print Head Using the Product Control Panel](#)

[Aligning the Print Head Using a Computer Utility](#)

Parent topic: [Print Head Maintenance](#)

Related concepts

[Print Head Cleaning](#)

Aligning the Print Head Using the Product Control Panel

You can align the print head using the control panel on your product.

1. Make sure plain paper is loaded in the product.
2. Press the  home button, if necessary.
3. Select **Setup**.
4. Select **Maintenance**.

You see this screen:



5. Select **Head Alignment**.

You see this screen:



6. Press the  start button to print an alignment sheet.

Note: Do not cancel printing while you are printing a head alignment pattern.

You see this screen:

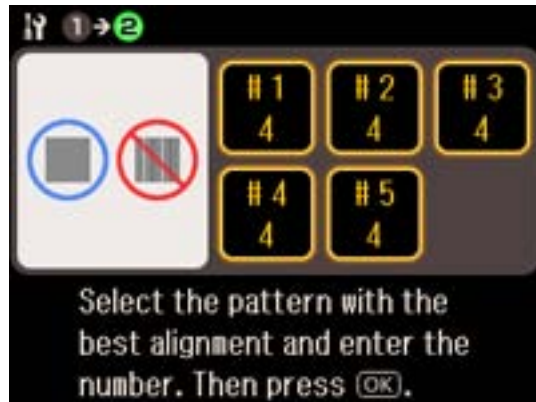

7. Check the printed pattern and choose the number representing the best printed pattern for each set.
8. Press the **OK** button when you are done.

Parent topic: [Print Head Alignment](#)

Aligning the Print Head Using a Computer Utility

You can align the print head using a utility on your Windows computer or Mac.

1. Load a few sheets of plain paper in the product.
2. Do one of the following:
 - **Windows:** Right-click the product icon in the Windows taskbar.
 - **Mac OS X 10.6/10.7:** In the Apple menu or the Dock, select **System Preferences**. Select **Print & Fax** or **Print & Scan**, select your product, and select **Options & Supplies**. Select **Utility** and select **Open Printer Utility**.
 - **Mac OS X 10.4/10.5:** In the Apple menu or the Dock, select **System Preferences**. Select **Print & Fax**, select your product, and select **Open Print Queue** or **Print Queue**. Select **Utility**.
3. Select **Print Head Alignment**.
4. Click **Next**, then click **Print** to print an alignment sheet.

Note: Do not cancel printing while you are printing a head alignment pattern.

You see one of these windows:

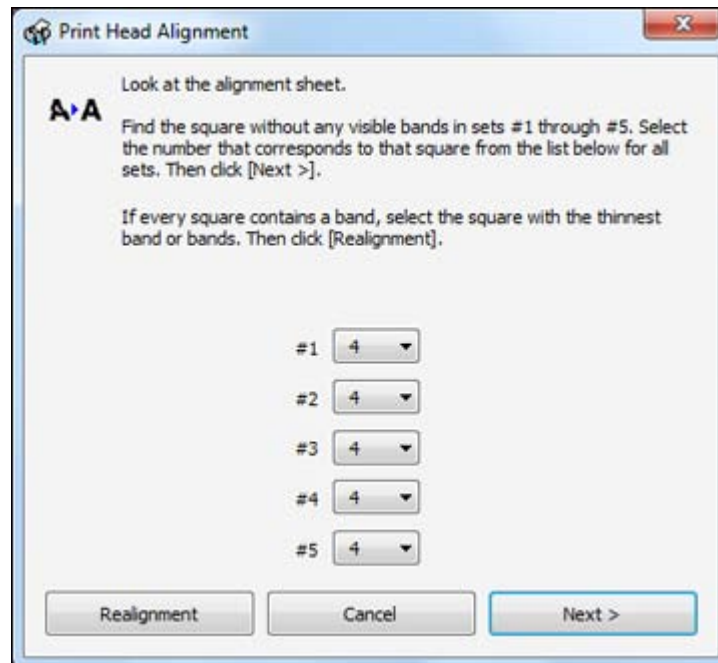

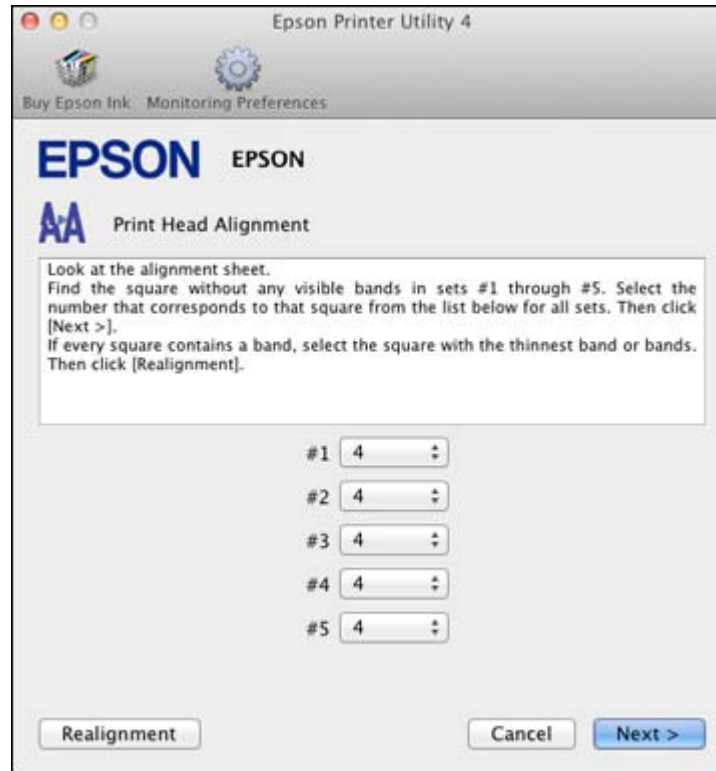

5. Check the printed pattern and follow the instructions on the screen to choose the number representing the best printed pattern for each set.
 - After choosing each pattern number, click **Next**.
 - If no patterns are aligned in one or more of the sets, choose the closest one in each set and click **Realignment**. Then print another alignment sheet and check it.

Note: Click **Skip** (where available) if you want to skip a particular alignment sheet.

6. When you are done, click **Finish**.

Parent topic: [Print Head Alignment](#)

Cleaning the Paper Path

If you see ink on the back of a printout, you can clean the paper path to remove any excess ink.

1. Load a few sheets of plain paper in the product.
2. Use the product control panel to make a copy, but without placing a document on the scanner glass.
3. Check the back of the ejected paper to see if it is clean.
4. Repeat as necessary until the paper comes out clean.

Parent topic: [Adjusting Print Quality](#)

Related topics

[Copying](#)

Cleaning and Transporting Your Product

See these sections if you need to clean or transport your product.

[Cleaning Your Product](#)

[Transporting Your Product](#)

Cleaning Your Product

To keep your product working at its best, you should clean it several times a year.

Caution: Do not use a hard brush, alcohol, or paint thinner to clean the product or you may damage it. Do not use oil or other lubricants inside the product or let water get inside it.

1. Turn off the product.
2. Unplug the power cable.
3. Disconnect any connected cables.
4. Remove all the paper from the paper cassettes.
5. Clean the paper cassettes using a soft brush.
6. Clean the scanner glass with a soft, lint-free cloth (microfiber is recommended), moistened with a little glass cleaner.

Caution: Do not spray glass cleaner directly on the glass and do not press the glass surface with any force.

7. Open the ADF cover and use a soft, dry, lint-free cloth (microfiber is recommended), to clean the rollers and the interior of the ADF.

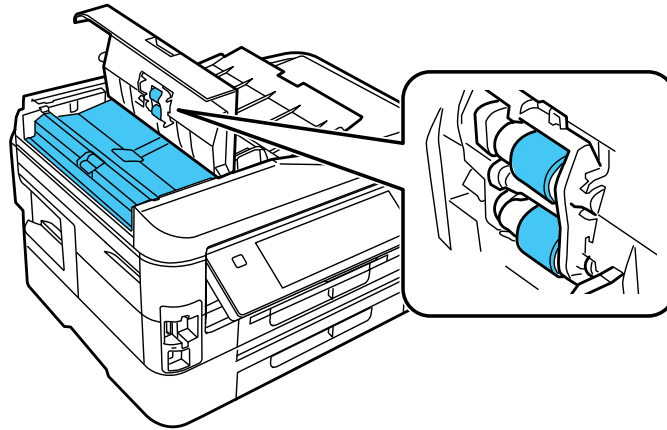

8. Clean the outer case and control panel with a soft, dry cloth. Do not use liquid or chemical cleansers.

Parent topic: [Cleaning and Transporting Your Product](#)

Related concepts

[Print Head Cleaning](#)

[Print Head Alignment](#)

Transporting Your Product

If you need to ship your product or transport it a long distance, prepare it for transportation as described here.

Caution: During transportation and storage, follow these guidelines:

- Avoid tilting the product, placing it vertically, or turning it upside down; otherwise ink may leak.
- Leave the ink cartridges installed. Removing the cartridges can dry out the print head and may prevent the product from printing.

1. Turn off the product.
2. Remove all the paper from the product.
3. Unplug the power cable.
4. Disconnect any connected cables.
5. Close the ADF and output tray as shown.

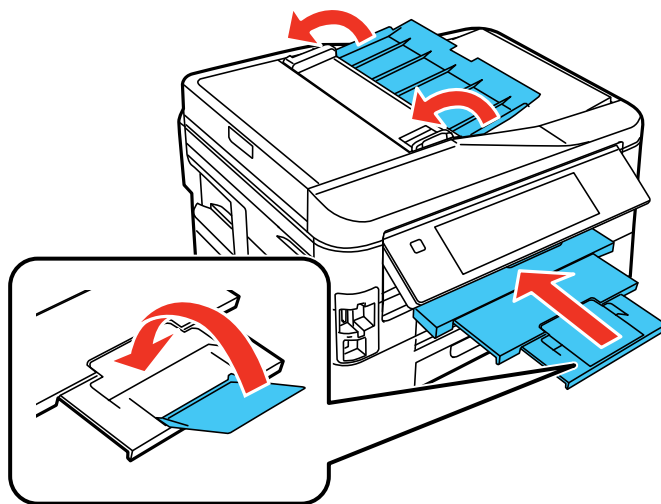

6. Place the product in its original packing materials, if possible, or use equivalent materials with cushioning around the product. Make sure the box adequately protects the product control panel.

Keep the product level during transportation. If print quality has declined when you print again, clean and align the print head.

Parent topic: [Cleaning and Transporting Your Product](#)

Solving Problems

Check these sections for solutions to problems you may have using your product.

[Checking for Software Updates](#)

[Product Status Messages](#)

[Running a Product Check](#)

[Resetting Control Panel Defaults](#)

[Solving Setup Problems](#)

[Solving Network Problems](#)

[Solving Copying Problems](#)

[Solving Paper Problems](#)

[Solving Problems Printing from a Computer](#)

[Solving Page Layout and Content Problems](#)

[Solving Print Quality Problems](#)

[Solving Scanning Problems](#)

[Solving Scanned Image Quality Problems](#)

[Solving Faxing Problems](#)

[When to Uninstall Your Product Software](#)

[Where to Get Help](#)

Checking for Software Updates

Periodically, it's a good idea to check Epson's support website for free updates to your product software. You can select **Download the Latest Software** from the Home screen of this manual or visit Epson's driver download site ([U.S. downloads](#) or [Canadian downloads](#)).

With Windows, your printer software automatically checks for updates. You can also manually update the software by selecting **Software Update** or **Driver Update** here:

- Right-clicking the product icon in the Windows taskbar
- On the **Maintenance** tab in the printer settings window
- In the **EPSON** program group under your product name





Parent topic: [Solving Problems](#)

Related tasks

[Changing Automatic Update Options](#)

Product Status Messages

You can often diagnose problems with your product by checking the messages on its LCD screen.

LCD screen message	Condition/solution
Paper out or paper jam	Follow the instructions on the screen to load paper in the indicated paper source or check for paper jams. Then press the  start button.
Paper jam while printing	Follow the instructions on the screen to see how to remove the jammed paper from the area indicated. Then press the  start button.
Paper feed error or jam	Follow the instructions on the screen to load paper in the indicated paper source or check for paper jams. Then press the  start button.
Incorrect paper size detected	Load the paper you want to print on, then press the  start button.
Communication error	Make sure the computer is connected to your product and your software is installed correctly.
Recovery mode	An error has occurred during firmware updating. Connect your product using a USB cable and try updating the firmware again. If you still receive this error message, contact Epson for support.
No dial tone detected. Try Check Fax Connection.	Make sure the phone cable is connected correctly and the phone line works. If you connected the product to a PBX (Private Branch Exchange) phone line or Terminal Adapter, turn off the Dial Tone Detection setting.
A printer error has occurred	Turn the product off and then back on again. If the error continues, make sure you removed the foam and plastic protective materials from inside the product.

Parent topic: [Solving Problems](#)

Related references

[Paper Jam Problems Inside the Product](#)

[Paper Jam Problems in a Cassette](#)

[Paper Jam Problems in the Duplexer](#)

[Document Jams in the Automatic Document Feeder](#)

[Where to Get Help](#)

Related topics

[Loading Paper](#)

Running a Product Check

Running a product check helps you determine if your product is operating properly.

1. Disconnect any interface cables connected to your product.
2. Load plain paper in the product.
3. Press the  home button, if necessary.
4. Select **Setup**.
5. Select **Maintenance**.

You see this screen:



6. Select **Nozzle Check**.

You see this screen:



7. Press the [start button icon] start button.

After the nozzle pattern prints, you see this screen:



8. Do the following, depending on the results of the product check:
 - If the page prints and the nozzle check pattern is complete, the product is operating properly. Any operation problem you may have could be caused by your computer, cable, software, or selected settings. Check the other solutions in this book or try uninstalling and reinstalling your printer software.
 - If the page prints but the nozzle check pattern has gaps, clean or align the print head.

- If the page does not print, the product may have a problem. Check the other solutions in this manual. If they do not work, contact Epson.

Parent topic: [Solving Problems](#)

Related concepts

[Print Head Cleaning](#)

[Print Head Alignment](#)

[When to Uninstall Your Product Software](#)

Related references

[Where to Get Help](#)

Resetting Control Panel Defaults

If you have a problem with settings on the product control panel, you can reset them to their factory defaults. You can choose which settings to reset or reset them all.

1. Press the  home button, if necessary.
2. Select **Setup**.
3. Press the arrow buttons and **Restore Default Settings**.

You see this screen:



4. Select one of these options:
 - **Reset Fax Send/Receive Settings:** Resets all settings for sending and receiving faxes

- **Reset Fax Data Settings:** Deletes the speed and group dial lists, header, and fax log
- **Reset Network Settings:** Resets all network settings.
- **Reset All except Network & Fax Settings:** Resets all control panel settings, except for network settings.
- **Reset All Settings:** Resets all control panel settings.

You see a confirmation screen.

5. Select **Yes** to reset the selected settings. (Select **No** if you want to cancel the operation.)

Parent topic: [Solving Problems](#)

Solving Setup Problems

Check these sections if you have problems while setting up your product.

[Noise After Ink Installation](#)

[Software Installation Problems](#)

[Control Panel Setup Problems](#)

Parent topic: [Solving Problems](#)

Noise After Ink Installation

If you hear noises from your product after installing ink, try these solutions:

- Make sure you removed the foam and plastic protective materials from inside the product.
- The first time you install ink cartridges, the product must prime its print head. Wait until priming finishes before you turn off the product, or it may prime improperly and use excess ink the next time you turn it on. Your product is finished priming the print head when the ⏻ power light stops flashing.
- If the product's print head stops moving or making noise, and the charging process has not finished after 5 minutes, turn off your product. Turn it back on and check to see if charging is still in progress. If it is still in progress, contact Epson for help.

Parent topic: [Solving Setup Problems](#)

Software Installation Problems

If you have problems while installing your product software, try these solutions:

- Make sure your product is turned on and the USB cable or network cable is securely connected at both ends. If you still have problems installing software, disconnect the cable and carefully follow the

instructions on the *Start Here* sheet. Also make sure your system meets the requirements for your operating system.

- Close any other programs, including screen savers and virus protection software, and install your product software again.
- In Windows, make sure your product is selected as the default printer and the correct port is shown in the printer properties.
- If you see any error message or your software does not install correctly in Windows, you may not have software installation privileges. Contact your System Administrator.

Parent topic: [Solving Setup Problems](#)

Related concepts

[When to Uninstall Your Product Software](#)

Related references

[Windows System Requirements](#)

[Mac System Requirements](#)

Control Panel Setup Problems

If you have problems setting up the control panel, try these solutions:

- To view LCD screen text in a different language, you can select a different **Language** setting.
- To adjust the position of the control panel, carefully raise or lower it using the release bar.
- To turn off the beep heard when you press a button, turn off the **Sound** setting. This also turns off the dialing sound for sending faxes.

Parent topic: [Solving Setup Problems](#)

Related tasks

[Changing LCD Screen Language](#)

[Turning Off Control Panel Sounds](#)

Solving Network Problems

Check these solutions if you have problems setting up or using your product on a network.

Note: Breakdown or repair of this product may cause loss of fax and network data and settings. Epson is not responsible for backing up or recovering data and settings during or after the warranty period. We recommend that you make your own backup or print out your fax and network data and settings.

[Product Cannot Connect to a Wireless Router or Access Point](#)
[Network Software Cannot Find Product on a Network](#)
[Product Does Not Appear in Mac OS X Printer Window](#)
[Cannot Print Over a Network](#)
[Cannot Scan Over a Network](#)
[Printing a Network Status Sheet](#)
Parent topic: [Solving Problems](#)

Product Cannot Connect to a Wireless Router or Access Point

If your product has trouble finding or connecting to a wireless router or access point, try these solutions :

- Make sure to place your product within contact range of your router or access point.

Note: Avoid placing your product near a microwave oven, 2.4 GHz cordless phone, or large metal object, such as a filing cabinet.

- Verify that your router or access point is operating correctly by connecting to it from your computer or another device.
- You may need to disable the firewall and any anti-virus software on your wireless router or access point.
- Check to see if access restrictions, such as MAC address filtering, are set on the router or access point. If access restrictions are set, add your product's MAC address to your router's address list. To obtain your product's MAC address, print a network status sheet. Then follow the instructions in your router or access point documentation to add the address to the list.
- If your router or access point does not broadcast its network name (SSID), follow the instructions that came with your product to enter your wireless network name manually.
- If your router or access point has security enabled, determine the kind of security it is using and any required password or passphrase for connection. Then make sure to enter the exact WEP key or WPA passphrase correctly.

Parent topic: [Solving Network Problems](#)

Network Software Cannot Find Product on a Network

If EpsonNet Setup cannot find your product on a network, try these solutions:

- Make sure your product is turned on and connected to your network. Verify connection using your product control panel.

- If necessary, reinstall your product software and try running EpsonNet Setup again.

Parent topic: [Solving Network Problems](#)

Related concepts

[When to Uninstall Your Product Software](#)

Product Does Not Appear in Mac OS X Printer Window

If your product does not appear in the Mac OS X printer window, try these solutions:

- Turn your product off, wait 30 seconds, then turn it back on again.
- If you are connecting the product via EpsonNet Setup and the WiFi light on your product is not solid green, make sure your product software was installed correctly. If necessary, reinstall your software.

Parent topic: [Solving Network Problems](#)

Cannot Print Over a Network

If you cannot print over a network, try these solutions:

- Make sure that your product is turned on.
- Make sure you install your product's network software as described in your product documentation.
- Print a network status sheet and verify that the network settings are correct. If the network status is **Disconnected**, check any cable connections and turn your product off and then on again.
- If you are using TCP/IP, make sure the product's IP address is set correctly for your network. If your network does not assign IP addresses using DHCP, set the IP address manually.
- Make sure your computer and product are both using the same wireless network.
- If network printing is slow, print a network status sheet and check the signal strength. If it is poor, place your product closer to your router or access point.

Note: Avoid placing your product near a microwave oven, 2.4 GHz cordless phone, or large metal object, such as a filing cabinet.

- If you are connecting the product via EpsonNet Setup and the WiFi light on your product is not solid green, make sure your product software was installed correctly. If necessary, reinstall your software.

Parent topic: [Solving Network Problems](#)

Related tasks

[Printing a Network Status Sheet](#)

Cannot Scan Over a Network

If you cannot start EPSON Scan for scanning over a network, try these solutions:

- If you are scanning a large original at a high resolution, a network communication error may occur. Try scanning again at a lower resolution.
- If network communication was interrupted while starting EPSON Scan, exit EPSON Scan, wait a few seconds, and restart it. If EPSON Scan cannot restart, turn off your product, turn it back on, and try restarting EPSON Scan again.
- Make sure the option selected as the **Timeout Setting** in the EPSON Scan Settings program is long enough to complete scanning over a network. See EPSON Scan Help for details.
- You may need to disable the firewall and any anti-virus software on your wireless router or access point.

Note: With Mac OS X 10.6 or 10.7, in addition to scanning with Image Capture, you can download and install EPSON Scan scanning software. EPSON Scan provides additional image adjustment and photo correction features for enhancing scanned images, and provides an interface for TWAIN-compliant OCR scanning software, such as ABBYY FineReader. To download EPSON Scan, visit Epson's driver download site ([U.S. downloads](#) or [Canadian downloads](#)).

Parent topic: [Solving Network Problems](#)

Related topics

[Scanning](#)

Printing a Network Status Sheet

You can print a network status sheet to help you determine the causes of any problems you may have using your product on a network.

1. Press the  home button, if necessary.
2. Select **Setup**.
3. Press the arrow buttons and select **Network Settings**.

You see this screen:

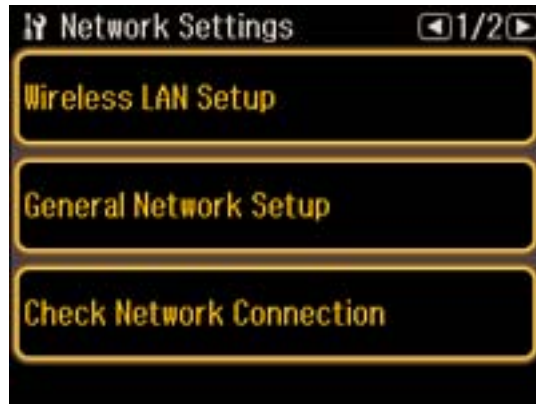

4. Press the arrow button and select **Confirm Network Settings**.
5. Press the \diamond start button to print the network status sheet.
(Select **Cancel** if you want to cancel the operation.)

Examine the settings shown on the network status sheet to diagnose any problems you have.

Parent topic: [Solving Network Problems](#)

Solving Copying Problems

Check these solutions if you have problems copying with your product.

[Product Makes Noise, But Nothing Copies](#)

[Product Makes Noise When It Sits for a While](#)

Parent topic: [Solving Problems](#)

Product Makes Noise, But Nothing Copies

If your product makes a noise, but nothing copies, try these solutions:

- Run a nozzle check to see if any of the print head nozzles are clogged. Then clean the print head, if necessary.
- If the nozzle check page does not print, but the product's power light is on, make sure your product software is installed correctly.
- Make sure your product is level (not tilted).

Parent topic: [Solving Copying Problems](#)

Related concepts

[Print Head Nozzle Check](#)

[Print Head Cleaning](#)

Product Makes Noise When It Sits for a While

Your product is performing routine maintenance. This is normal.

Parent topic: [Solving Copying Problems](#)

Solving Paper Problems

Check these sections if you have problems using paper with your product.

[Paper Feeding Problems](#)

[Paper Jam Problems Inside the Product](#)

[Paper Jam Problems in a Cassette](#)

[Paper Jam Problems in the Duplexer](#)

[Document Jams in the Automatic Document Feeder](#)

[Paper Ejection Problems](#)

Parent topic: [Solving Problems](#)

Paper Feeding Problems

If you have problems feeding paper, try these solutions:

- If paper does not feed correctly, remove and reload it against the right side of the cassette and adjust the edge guides. Make sure the paper stack is not above the tab on the edge guides inside the cassette.
- If multiple pages feed at once, remove the paper, fan the edges to separate the sheets, and reload it.
- Do not load more than the recommended number of sheets.
- If paper jams when you print on both sides of the paper, try loading fewer sheets.
- For best results, follow these guidelines:
 - Use new, smooth, high-quality paper that is not curled, creased, old, too thin, or too thick.
 - Load paper in the cassette printable side down.
 - Do not load paper with holes punched in it.
 - Follow any special loading instructions that came with the paper.

Parent topic: [Solving Paper Problems](#)

Related references

[Paper Jam Problems Inside the Product](#)

[Paper Jam Problems in a Cassette](#)

[Paper Jam Problems in the Duplexer](#)

[Document Jams in the Automatic Document Feeder](#)

[Paper Loading Capacity](#)

Related topics

[Loading Paper](#)

Paper Jam Problems Inside the Product

If paper has jammed inside the product, try this solution:

1. Cancel the print job from your computer, if necessary.
2. Open the scanner unit.
3. Remove any paper inside, including torn pieces.

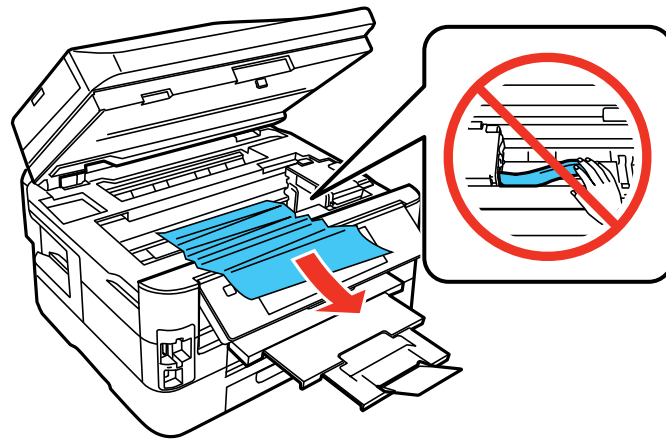

4. Close the scanner unit.

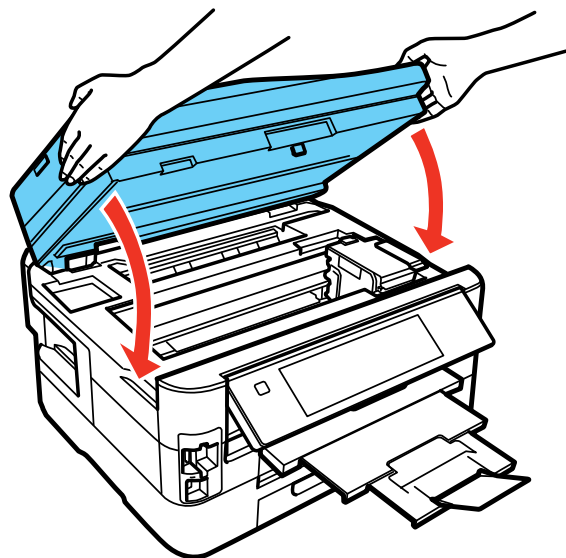

5. If any jammed paper remains near the output tray, carefully remove it.
6. Press the  start button to resume printing.

Parent topic: [Solving Paper Problems](#)

Paper Jam Problems in a Cassette

If paper has jammed in one of the cassettes, try this solution:

1. Close the output tray.
2. Pull out both of the paper cassettes.

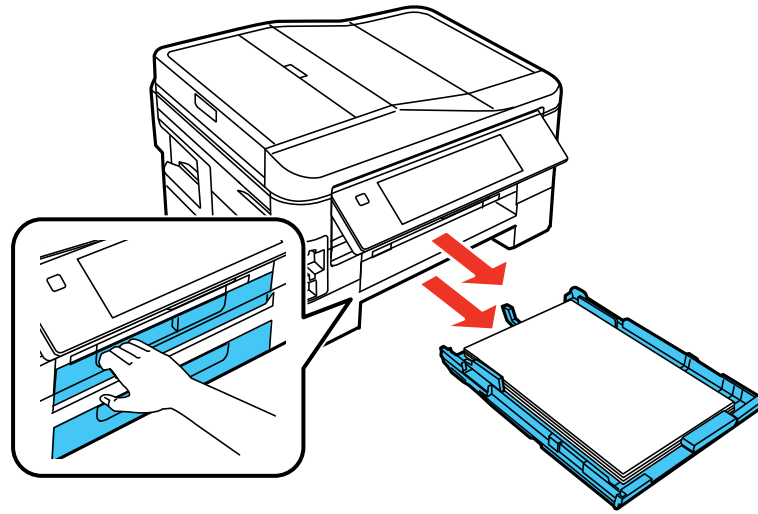

3. Remove any jammed paper inside the cassettes.
4. Remove any paper jammed inside the paper cassette slot.

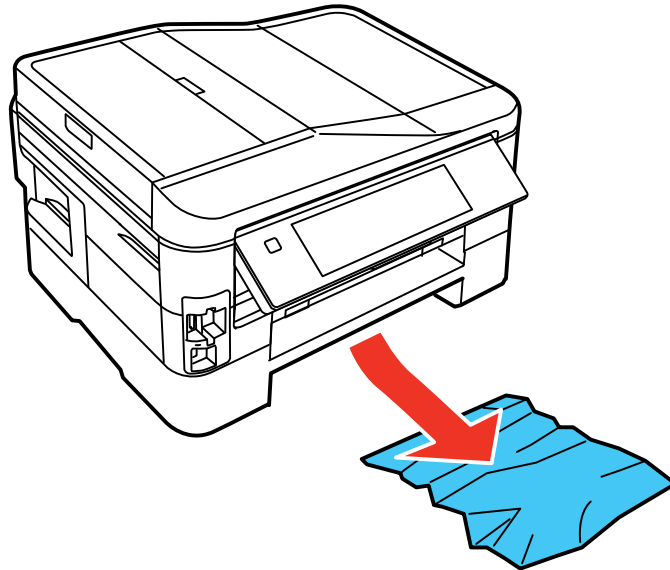

5. Carefully follow all paper loading instructions when you load new paper.
6. Replace the paper cassettes.

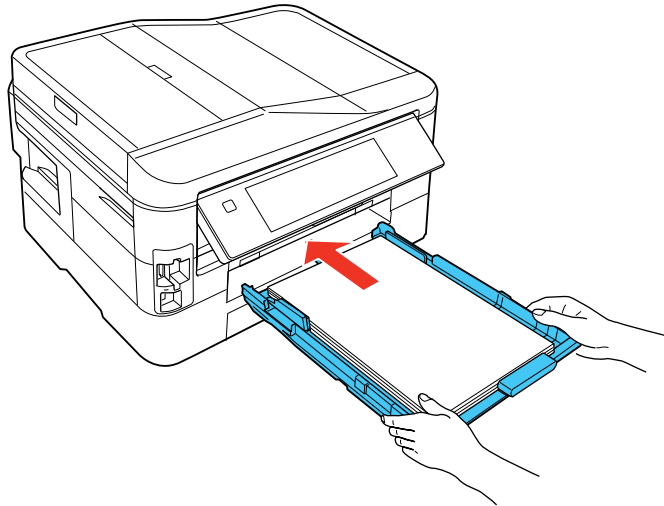

7. Press the  start button to resume printing.

Parent topic: [Solving Paper Problems](#)

Paper Jam Problems in the Duplexer

If paper has jammed in the duplexer (rear unit), try these solutions:

1. Cancel the print job from your computer, if necessary.
2. Squeeze the buttons to release the duplexer and remove it.

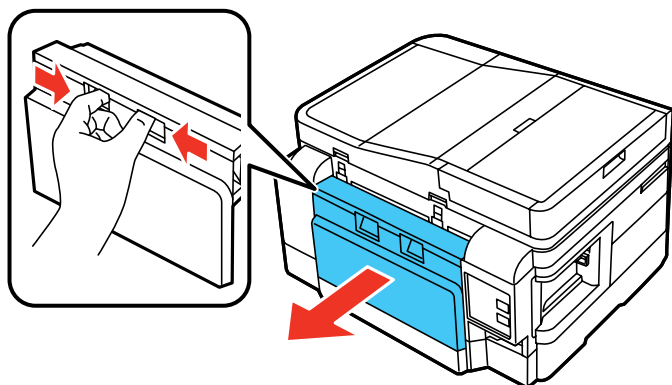

3. Carefully remove the jammed paper, making sure not to touch the rollers.

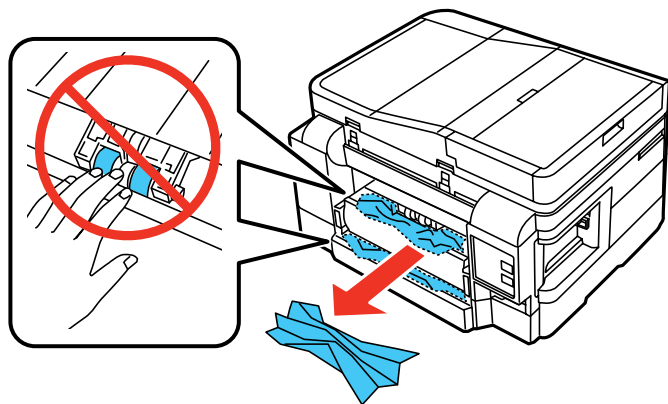

4. If paper is jammed in the duplexer, remove the paper as shown.

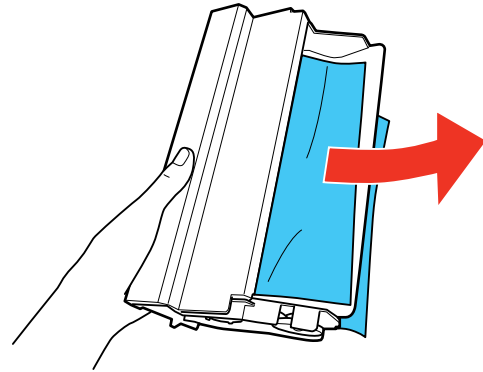

5. Squeeze the buttons on the duplexer as you press it into place on your product.

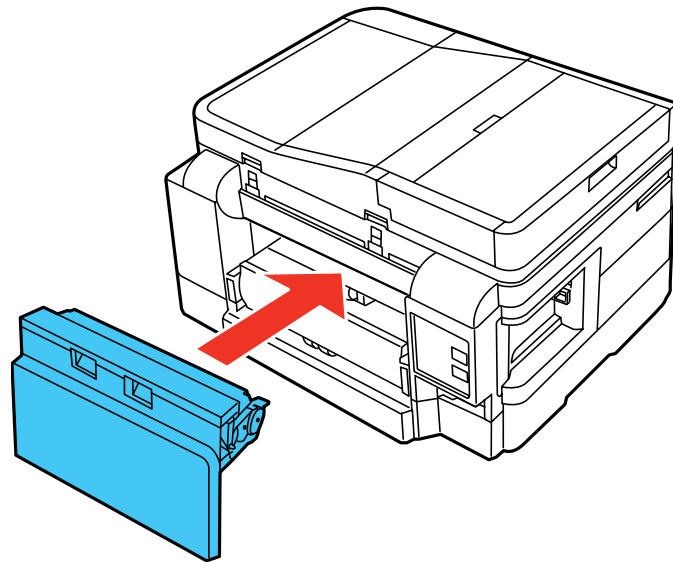

6. Press the  start button to resume printing.

Parent topic: [Solving Paper Problems](#)

Related references

[Paper Jam Problems Inside the Product](#)

Paper Jam Problems in a Cassette

Related tasks

[Placing Originals in the Automatic Document Feeder](#)

Document Jams in the Automatic Document Feeder

If you have problems with document jams in the automatic document feeder (ADF), try these solutions:

1. Remove your originals from the ADF.
2. Open the ADF cover.

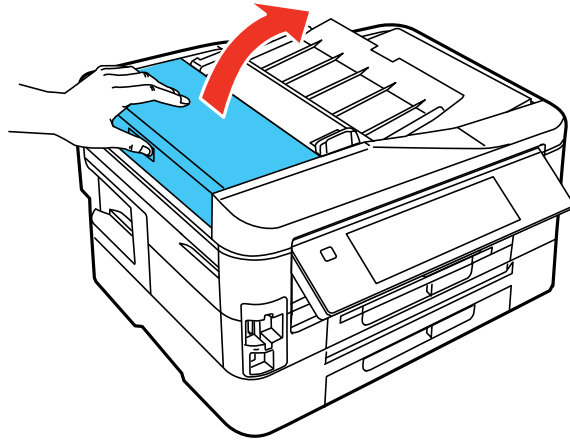

3. Remove any jammed pages.

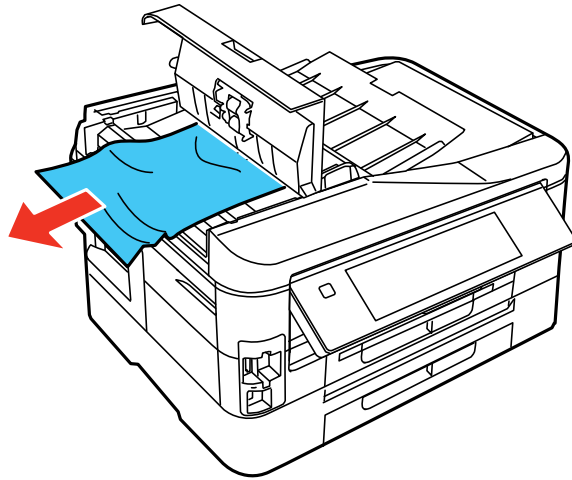

Caution: Do not remove pages jammed inside the ADF without opening the cover or you could damage the ADF.

4. Leave the ADF cover open, then raise the document cover.
5. Remove any jammed pages.

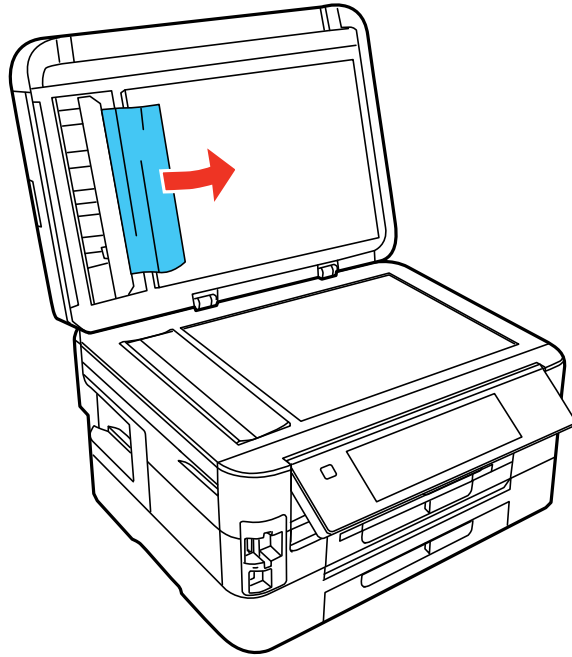

6. Lower the document cover.
7. Raise the ADF input tray.

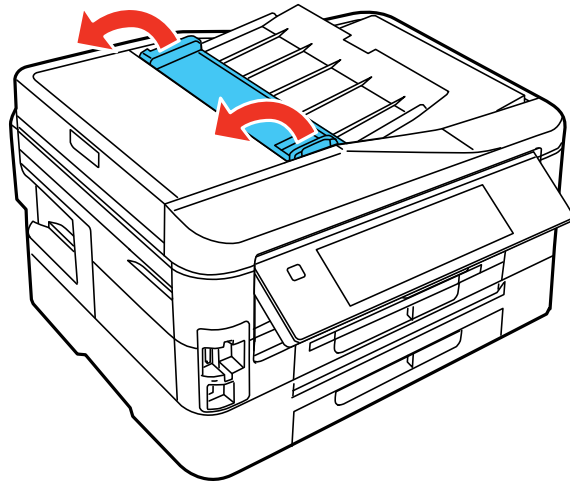

8. Carefully remove the jammed pages.

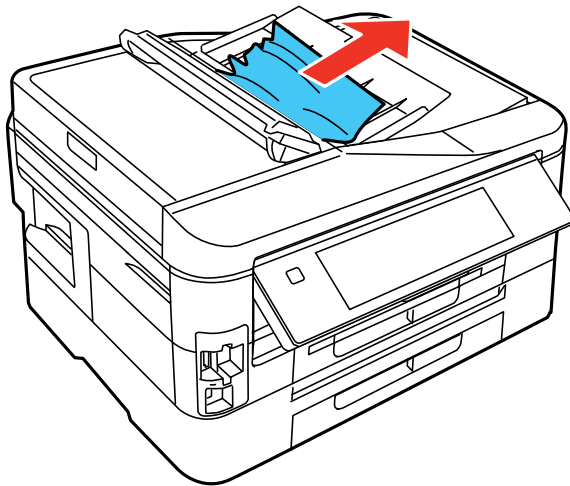

9. Lower the ADF input tray and reload your originals.

Caution: Make sure you do not load the ADF beyond its capacity for your paper size. Also make sure the originals you load are not bent, folded, or curled and do not have tape, staples, or other materials that could obstruct the feeder.

10. Follow the prompts on the LCD screen to clear any error messages.

Parent topic: [Solving Paper Problems](#)

Related tasks

[Placing Originals in the Automatic Document Feeder](#)

Paper Ejection Problems

If you have problems with paper ejecting properly, try these solutions:

- If paper does not eject fully, you may have set the wrong paper size. Cancel printing to eject the paper. Select the correct paper size when you reprint.
- If paper is wrinkled when it ejects, it may be damp or too thin. Load new paper and be sure to select the correct paper type setting when you reprint.

Parent topic: [Solving Paper Problems](#)

Related references

[Paper Jam Problems Inside the Product](#)

[Paper Jam Problems in a Cassette](#)

[Paper Jam Problems in the Duplexer](#)

[Paper or Media Type Settings](#)

Related tasks

[Cancelling Printing Using a Product Button](#)

Related topics

[Loading Paper](#)

Solving Problems Printing from a Computer

Check these sections if you have problems while printing from your computer.

[Nothing Prints](#)

[Product Icon Does Not Appear in Windows Taskbar](#)



[Error After Cartridge Replacement](#)

[Printing is Slow](#)

Parent topic: [Solving Problems](#)

Nothing Prints

If you have sent a print job and nothing prints, try these solutions:

- Make sure your product is turned on.
- Make sure any interface cables are connected securely at both ends.
- If you connected your product to a USB hub, make sure it is a first-tier hub. If it still does not print, connect your product directly to your computer instead of the hub.
- Run a product check to see if a test page prints. If the test page prints, check to see if your product software is installed correctly.
- In Windows, make sure your product is selected as the default printer.
- In Windows, clear any stalled print jobs from the Windows Spooler:
 - **Windows 7:** Click  and select **Devices and Printers**. Right-click your product name, select **See what's printing**, select your product name again if necessary, right-click the stalled print job, click **Cancel**, and click **Yes**.
 - **Windows Vista:** Click  and select **Control Panel**. Click **Printer** under **Hardware and Sound**, right-click your product name, select **Open**, right click the stalled print job, click **Cancel**, and click **Yes**.
 - **Windows XP:** Click **Start** and select **Printers and Faxes**. (Or open the **Control Panel**, select **Printers and Other Hardware** if necessary, and select **Printers and Faxes**.) Right-click your product name, select **Open**, right-click the stalled print job, click **Cancel**, and click **Yes**.

Parent topic: [Solving Problems Printing from a Computer](#)



Related tasks

[Running a Product Check](#)

Product Icon Does Not Appear in Windows Taskbar

If you do not see your product icon in the Windows taskbar, first try restarting your computer. If that does not work, try this solution:

1. Do one of the following:

- **Windows 7:** Click  and select **Devices and Printers**.
- **Windows Vista:** Click , select **Control Panel**, and click **Printer** under **Hardware and Sound**.

- **Windows XP:** Click **Start** and select **Printers and Faxes**. (Or open the **Control Panel**, select **Printers and Other Hardware** if necessary, and **Printers and Faxes**.)
2. Right-click your product name, select **Printing Preferences**, and select your product name again if necessary.
 3. Click the **Maintenance** tab.
 4. Click the **Speed & Progress** or **Extended Settings** button.
 5. Click the **Monitoring Preferences** button.
 6. Click the **Shortcut Icon** box.
 7. Click **OK** to close the open program windows.

Parent topic: [Solving Problems Printing from a Computer](#)

Error After Cartridge Replacement

If you see an error light or error message after you replace an ink cartridge, follow these steps:

1. Make sure the print head is in the ink cartridge replacement position. (The ink cartridge holder should be beneath the cutout in the product case, allowing access to the cartridges.)

Note: If the print head is not in the correct position, press the **Cancel** button to move it to the ink cartridge replacement position.

2. Remove and reinsert the ink cartridge you replaced, making sure to push it all the way into its slot.
3. Complete the ink cartridge installation steps.

Parent topic: [Solving Problems Printing from a Computer](#)

Related tasks

[Removing and Installing Ink Cartridges](#)

Printing is Slow

If printing becomes slow, try these solutions:

- Make sure your system meets the requirements for your operating system. If you are printing a high-resolution image, you may need more than the minimum requirements. If necessary, increase your system's memory.
- If you are using Windows 7, close the **Devices and Printers** window before you print.
- Clear space on your hard drive or run a defragmentation utility to free up existing space.

- Close any programs you are not using when you print.
- If your product is connected to a USB hub, connect it directly to your computer instead.
- If printing becomes slower after printing continuously for a long time, the product may have automatically slowed down to protect the print mechanism from overheating or becoming damaged. Let the product rest with the power on for 30 minutes, then try printing again.

For the fastest printing, select the following settings in your product software:

- Make sure the paper type setting matches the type of paper you loaded.
- Turn on any high speed settings in your product software.
- Select a lower print quality setting.
- **Windows:** Click the **Maintenance** tab, select **Speed & Progress** or **Extended Settings**, and select the following settings:
 - **High Speed Copies**
 - **Always spool RAW datatype**
 - **Page Rendering Mode**
 - **Print as Bitmap**

Parent topic: [Solving Problems Printing from a Computer](#)

Related references

[Windows System Requirements](#)

[Mac System Requirements](#)

[Paper or Media Type Settings](#)

Related tasks

[Selecting Basic Print Settings - Windows](#)

[Selecting Basic Print Settings - Mac OS X 10.5/10.6/10.7](#)

[Selecting Basic Print Settings - Mac OS X 10.4](#)

Solving Page Layout and Content Problems

Check these sections if you have problems with the layout or content of your printed pages.

[Inverted Image](#)

[Too Many Copies Print](#)

[Blank Pages Print](#)

[Incorrect Margins on Printout](#)

[Incorrect Characters Print](#)
[Incorrect Image Size or Position](#)
[Slanted Printout](#)

Parent topic: [Solving Problems](#)

Inverted Image

If your printed image is inverted unexpectedly, try these solutions:

- Turn off any mirror or inversion settings in your printing application.
- Turn off the **Mirror Image**, **Flip horizontally**, or **Reverse page orientation** settings in your printer software. (This option has different names, depending on your operating system version.)

Note: Leave these options turned on when you print on EPSON Iron-on Cool Peel Transfer paper, if available for your product.

Parent topic: [Solving Page Layout and Content Problems](#)

Related tasks

[Selecting Additional Layout and Print Options - Windows](#)
[Selecting Basic Print Settings - Mac OS X 10.5/10.6/10.7](#)
[Selecting Basic Print Settings - Mac OS X 10.4](#)

Too Many Copies Print

Make sure that the **Copies** setting in your printing program or printer software is not set for multiple copies.

Parent topic: [Solving Page Layout and Content Problems](#)

Related tasks

[Selecting Additional Layout and Print Options - Windows](#)
[Selecting Basic Print Settings - Mac OS X 10.5/10.6/10.7](#)
[Selecting Basic Print Settings - Mac OS X 10.4](#)

Blank Pages Print

If blank pages print unexpectedly, try these solutions:

- Make sure you selected the correct paper size settings in your printing program and printer software.

- If a blank page exists in a document you are printing and you want to skip printing it, select the **Skip Blank Page** setting in your printer software.
- Run a print head nozzle check to see if any of the nozzles are clogged. Then clean the print head, if necessary.
- Make sure your product is selected as the printer in your printing program.

Parent topic: [Solving Page Layout and Content Problems](#)

Related concepts

[Print Head Nozzle Check](#)

[Print Head Cleaning](#)

Related tasks

[Selecting Basic Print Settings - Windows](#)

[Selecting Basic Print Settings - Mac OS X 10.5/10.6/10.7](#)

[Selecting Basic Print Settings - Mac OS X 10.4](#)

[Selecting Printing Preferences - Mac OS X 10.5/10.6/10.7](#)

[Selecting Printing Preferences - Mac OS X 10.4](#)

Incorrect Margins on Printout

If your printed page has incorrect margins, try these solutions:

- Make sure you selected the correct paper size settings in your printing program and printer software.
- Make sure you selected the correct margins for your paper size in your printing program.
- Make sure your paper is positioned correctly for feeding into the printer.

You can use the preview option in your printer software to check your margins before you print.

Parent topic: [Solving Page Layout and Content Problems](#)

Related tasks

[Selecting Basic Print Settings - Windows](#)

[Selecting Basic Print Settings - Mac OS X 10.5/10.6/10.7](#)



[Selecting Basic Print Settings - Mac OS X 10.4](#)

Related topics

[Loading Paper](#)

Incorrect Characters Print

If incorrect characters appear in your prints, try these solutions before reprinting:

- Make sure any cables are securely connected at both ends.
- In Windows, delete all print jobs from the Windows Spooler:
 - **Windows 7:** Click  and select **Devices and Printers**. Right-click your product name, select **See what's printing**, select your product name again if necessary, right-click the stalled print job, click **Cancel**, and click **Yes**.
 - **Windows Vista:** Click  and select **Control Panel**. Click **Printer** under **Hardware and Sound**, right-click your product name, select **Open**, right click the stalled print job, click **Cancel**, and click **Yes**.
 - **Windows XP:** Click **Start** and select **Printers and Faxes**. (Or open the **Control Panel**, select **Printers and Other Hardware** if necessary, and select **Printers and Faxes**.) Right-click your product name, select **Open**, right-click the stalled print job, click **Cancel**, and click **Yes**.
- Make sure your product is selected as the printer in your printing program.
- If your product is connected to a USB hub, connect it directly to your computer instead.

Parent topic: [Solving Page Layout and Content Problems](#)

Incorrect Image Size or Position

If your printed image is the wrong size or in the wrong position, try these solutions:

- Make sure you selected the correct paper size and layout settings in your printing program and printer software.
- Make sure your paper is positioned correctly for feeding into the printer.

You can use the preview option in your printer software to check your margins before you print.

Parent topic: [Solving Page Layout and Content Problems](#)

Related tasks

[Selecting Basic Print Settings - Windows](#)

[Selecting Basic Print Settings - Mac OS X 10.5/10.6/10.7](#)

[Selecting Basic Print Settings - Mac OS X 10.4](#)

[Selecting Additional Layout and Print Options - Windows](#)

[Selecting Print Layout Options - Mac OS X 10.5/10.6/10.7](#)

[Selecting Page Setup Settings - Mac OS X 10.4](#)

Slanted Printout

If your printouts are slanted, try these solutions:

- Slide the edge guides against the edges of the paper.
- Select a higher print quality setting in your printer software.
- Align the print head.
- Make sure the product is not printing while tilted or at an angle.

Parent topic: [Solving Page Layout and Content Problems](#)

Related tasks

[Selecting Basic Print Settings - Windows](#)

[Selecting Basic Print Settings - Mac OS X 10.5/10.6/10.7](#)

[Selecting Basic Print Settings - Mac OS X 10.4](#)

Related topics

[Loading Paper](#)

Solving Print Quality Problems

Check these sections if your printouts have problems with print quality, but your image looks fine on your computer screen.

[White or Dark Lines in Printout](#)

[Blurry or Smearred Printout](#)

[Faint Printout or Printout Has Gaps](#)

[Grainy Printout](#)

[Incorrect Colors](#)

Parent topic: [Solving Problems](#)

Related topics

[Solving Scanned Image Quality Problems](#)

White or Dark Lines in Printout

If you notice white or dark lines in your prints (also called banding), try these solutions before you reprint:

- Run a nozzle check to see if any of the print head nozzles are clogged. Then clean the print head, if necessary.
- Make sure the paper type setting matches the type of paper you loaded.

- Make sure you loaded the printable side of the paper facedown in the cassette.
- Turn off any high speed settings in your product software.
- Align the print head.
- You may need to replace the ink cartridges.

Parent topic: [Solving Print Quality Problems](#)

Related concepts

[Print Head Cleaning](#)

[Print Head Alignment](#)

Related references

[Paper or Media Type Settings](#)

Related tasks

[Selecting Additional Layout and Print Options - Windows](#)

[Selecting Printing Preferences - Mac OS X 10.5/10.6/10.7](#)

[Selecting Printing Preferences - Mac OS X 10.4](#)

Blurry or Smearred Printout

If your printouts are blurry or smearred, try these solutions:

- Make sure your paper is not damp, curled, old, or loaded faceup in one of the cassettes (the printable side should be facedown).
- Use a support sheet with special paper, or load special paper one sheet at a time.
- Make sure your paper meets the specifications for your product.
- Use EPSON papers to ensure proper saturation and absorption of genuine EPSON inks.
- Make sure the paper type setting in your product software matches the type of paper you loaded.
- Remove each sheet from the output tray as it is printed.
- Avoid handling printouts on glossy paper right after printing to allow the ink to set.
- Turn off any high speed settings in your product software.
- If you print on both sides of a sheet of paper, smudges may appear on the reverse side of heavily saturated or dark images. If one side of a sheet will contain a lighter image or text, print that side first. Adjust the **Print Density** and/or **Ink Drying Time** settings.
- Run a nozzle check to see if any of the print head nozzles are clogged. Then clean the print head, if necessary.

- Align the print head.
- Clean the paper path.

Note: Your product will not operate properly while tilted at an angle. Place it on a flat, stable surface that extends beyond the base of the product in all directions.

Parent topic: [Solving Print Quality Problems](#)

Related concepts

[Print Head Cleaning](#)

[Print Head Alignment](#)

Related references

[Available EPSON Papers](#)

[Paper Specifications](#)

Related tasks

[Selecting Basic Print Settings - Windows](#)

[Selecting Additional Layout and Print Options - Windows](#)

[Selecting Double-sided Printing Settings - Windows](#)

[Selecting Basic Print Settings - Mac OS X 10.5/10.6/10.7](#)

[Selecting Printing Preferences - Mac OS X 10.5/10.6/10.7](#)

[Selecting Double-sided Printing Settings - Mac OS X 10.5/10.6/10.7](#)

[Selecting Basic Print Settings - Mac OS X 10.4](#)

[Selecting Printing Preferences - Mac OS X 10.4](#)

[Selecting Double-sided Printing Settings - Mac OS X 10.4](#)

[Cleaning the Paper Path](#)

Related topics

[Loading Paper](#)

Faint Printout or Printout Has Gaps

If your printouts are faint or have gaps, try these solutions:

- Run a nozzle check to see if any of the print head nozzles are clogged. Then clean the print head, if necessary.
- The ink cartridges may be old or low on ink, and you may need to replace them.
- Make sure the paper type setting matches the type of paper you loaded.

- Make sure your paper is not damp, curled, old, or loaded faceup in the cassette (the printable side should be facedown).
- Align the print head.
- Clean the paper path.

Parent topic: [Solving Print Quality Problems](#)

Related concepts

[Print Head Cleaning](#)

Related tasks

[Selecting Basic Print Settings - Windows](#)

[Selecting Basic Print Settings - Mac OS X 10.5/10.6/10.7](#)

[Selecting Basic Print Settings - Mac OS X 10.4](#)

[Cleaning the Paper Path](#)

[Removing and Installing Ink Cartridges](#)

Grainy Printout

If your printouts are grainy, try these solutions:

- Make sure you loaded the printable side of the paper facedown in the cassette.
- Select a higher print quality setting and turn off any high speed settings in your product software.
- Run a nozzle check to see if any of the print head nozzles are clogged. Then clean the print head, if necessary.
- Align the print head.
- You may need to increase the image resolution or print a smaller size; see your software documentation.

Parent topic: [Solving Print Quality Problems](#)

Related concepts

[Print Head Alignment](#)

Related tasks

[Selecting Additional Layout and Print Options - Windows](#)

[Selecting Basic Print Settings - Mac OS X 10.5/10.6/10.7](#)

[Selecting Printing Preferences - Mac OS X 10.5/10.6/10.7](#)

[Selecting Basic Print Settings - Mac OS X 10.4](#)

[Selecting Printing Preferences - Mac OS X 10.4](#)

Related topics

[Loading Paper](#)

Incorrect Colors

If your printouts have incorrect colors, try these solutions:

- Make sure the **Black/Grayscale** or **Grayscale** setting is not selected in your printer software.
- Run a nozzle check to see if any of the print head nozzles are clogged. Then clean the print head, if necessary.
- The ink cartridges may be old or low on ink, and you may need to replace them.
- Your printed colors can never exactly match your on-screen colors. However, you can use a color management system to get as close as possible. Try using the color management options in your printer software.
- For best results, use genuine EPSON ink and paper.

Parent topic: [Solving Print Quality Problems](#)

Related concepts

[Print Head Cleaning](#)

Related references

[Available EPSON Papers](#)

Related tasks

[Selecting Additional Layout and Print Options - Windows](#)

[Managing Color - Mac OS X 10.4](#)

[Removing and Installing Ink Cartridges](#)

Solving Scanning Problems

Check these solutions if you have problems scanning with your product.

[Scanning Software Does Not Operate Correctly](#)

[Cannot Start EPSON Scan](#)

Parent topic: [Solving Problems](#)

Scanning Software Does Not Operate Correctly

If your scanning software does not operate correctly, try these solutions:

- Make sure your computer has adequate memory and meets the system requirements for your operating system.
- Make sure your computer is not running in a power-saving mode, such as sleep or standby. If so, wake your system and restart your scanning software.
- If you upgraded your operating system but did not reinstall your scanning software, try reinstalling it.

Note: With Mac OS X 10.6 or 10.7, in addition to scanning with Image Capture, you can download and install EPSON Scan scanning software. EPSON Scan provides additional image adjustment and photo correction features for enhancing scanned images, and provides an interface for TWAIN-compliant OCR scanning software, such as ABBYY FineReader. To download EPSON Scan, visit Epson's driver download site ([U.S. downloads](#) or [Canadian downloads](#)).

Parent topic: [Solving Scanning Problems](#)

Related references

[Windows System Requirements](#)

[Mac System Requirements](#)

Cannot Start EPSON Scan

If you cannot start EPSON Scan, try these solutions:

- Make sure your product is turned on and any interface cables are securely connected at both ends.
- Make sure EPSON Scan is selected in your scanning program.
- Make sure your computer is not running in a power-saving mode, such as sleep or standby. If so, wake your system and restart EPSON Scan.
- Make sure you do not have multiple versions of EPSON Scan installed. If you do, uninstall both versions and install one version.
- If you upgraded your operating system but did not reinstall EPSON Scan, try reinstalling it.

Note: With Mac OS X 10.6 or 10.7, in addition to scanning with Image Capture, you can download and install EPSON Scan scanning software. EPSON Scan provides additional image adjustment and photo correction features for enhancing scanned images, and provides an interface for TWAIN-compliant OCR scanning software, such as ABBYY FineReader. To download EPSON Scan, visit Epson's driver download site ([U.S. downloads](#) or [Canadian downloads](#)).

Parent topic: [Solving Scanning Problems](#)

Related tasks

[Scanning with Mac OS X 10.6/10.7 Using Image Capture](#)

Related topics

[Starting a Scan](#)

Solving Scanned Image Quality Problems

Check these sections if a scanned image on your computer screen has a quality problem.

[Image Consists of a Few Dots Only](#)

[Line of Dots Appears in All Scanned Images](#)

[Straight Lines in an Image Appear Crooked](#)

[Image is Distorted or Blurry](#)

[Image Colors are Patchy at the Edges](#)

[Image is Too Dark](#)

[Back of Original Image Appears in Scanned Image](#)

[Ripple Patterns Appear in an Image](#)

[Scanned Image Colors Do Not Match Original Colors](#)

[Scan Area is Not Adjustable in Thumbnail Preview](#)

[Scanned Image Edges are Cropped](#)

Parent topic: [Solving Problems](#)

Related topics

[Solving Print Quality Problems](#)

Image Consists of a Few Dots Only

If your scanned image consists only of a few dots, try these solutions:

- Make sure you placed your original for scanning facing the correct way.
- If you are scanning using the EPSON Scan **Black & White** setting, adjust the **Threshold** setting and scan again.

Parent topic: [Solving Scanned Image Quality Problems](#)

Related tasks

[Cleaning Your Product](#)

Line of Dots Appears in All Scanned Images

If a line of dots appears in all your scanned images, clean the scanner glass with a soft, dry, lint-free cloth or use a small amount of glass cleaner on the cloth, if necessary. Paper towels are not recommended.

Caution: Do not spray glass cleaner directly on the scanner glass.

Parent topic: [Solving Scanned Image Quality Problems](#)

Straight Lines in an Image Appear Crooked

If straight lines in an original appear crooked in a scanned image, make sure to place your original straight when you scan it.

Parent topic: [Solving Scanned Image Quality Problems](#)

Related topics

[Placing Originals on the Product](#)

Image is Distorted or Blurry

If a scanned image appears distorted or blurry, try these solutions:

- Make sure your original is not wrinkled or warped. This may prevent the original from laying flat on the scanner glass.
- Do not move your original or your product during scanning.
- Your product will not operate properly while tilted at an angle. Place it on a flat, stable surface that extends beyond the base of the product in all directions.
- Adjust these EPSON Scan settings (if available) and try scanning again:
 - Select the **Unsharp Mask** setting.
 - Adjust the **Auto Exposure** setting.
 - Increase the **Resolution** setting.

Parent topic: [Solving Scanned Image Quality Problems](#)

Related topics

[Selecting EPSON Scan Settings](#)

Image Colors are Patchy at the Edges

If you are scanning a thick or warped original, cover its edges with paper to block external light as you scan it.

Parent topic: [Solving Scanned Image Quality Problems](#)

Image is Too Dark

If your scanned image is too dark, try these solutions:

- Adjust these EPSON Scan settings (if available) and try scanning again:
 - **Auto Exposure**
 - **Brightness**
 - **Histogram Adjustment**
- Check the brightness and contrast settings of your computer monitor.

Parent topic: [Solving Scanned Image Quality Problems](#)

Related topics

[Selecting EPSON Scan Settings](#)

Back of Original Image Appears in Scanned Image

If an image from the back of a thin original appears in your scanned image, place a piece of black paper on the back of the original and scan it again.

Parent topic: [Solving Scanned Image Quality Problems](#)

Ripple Patterns Appear in an Image

You may see a ripple pattern (called a moiré) in scanned images of printed documents. This is caused by interference from differing pitches in the scanner's screen and your original's halftone screen. To reduce this effect, adjust these EPSON Scan settings (if available) and try scanning again:

- Select the **Descreening** setting.
- Select a lower **Resolution** setting.

Parent topic: [Solving Scanned Image Quality Problems](#)

Related topics

[Selecting EPSON Scan Settings](#)

Scanned Image Colors Do Not Match Original Colors

Printed colors can never exactly match the colors on your computer monitor because printers and monitors use different color systems: monitors use RGB (red, green, and blue) and printers typically use CMYK (cyan, magenta, yellow, and black).

Check the color matching and color management capabilities of your computer, display adapter, and the software you are using to see if they are affecting the palette of colors you see on your screen.

To adjust the colors in your scanned image, adjust these EPSON Scan settings (if available) and try scanning again:

- Change the **Image Type** setting and experiment with different combinations of the next settings.
- Adjust the **Tone Correction** setting.
- Adjust the **Auto Exposure** setting.

Parent topic: [Solving Scanned Image Quality Problems](#)

Related topics

[Selecting EPSON Scan Settings](#)

Scan Area is Not Adjustable in Thumbnail Preview

If you cannot adjust the scan area while viewing a Thumbnail preview in EPSON Scan, try these solutions:

- Create a scan area by drawing a marquee on your preview image and adjusting it as necessary.
- Switch to Normal preview mode, if available, and preview your image again.

Parent topic: [Solving Scanned Image Quality Problems](#)

Related concepts

[Image Preview Guidelines](#)

Related tasks

[Scanning in Home Mode](#)

[Scanning in Office Mode](#)

[Scanning in Professional Mode](#)

Scanned Image Edges are Cropped

If the edges of a scanned image are cropped, make sure your original is placed correctly for scanning. If necessary, move your original away from the edges of the scanner glass slightly.

Parent topic: [Solving Scanned Image Quality Problems](#)

Related topics

[Placing Originals on the Product](#)

Solving Faxing Problems

Check these solutions if you have problems faxing with your product.

[Cannot Send or Receive Faxes](#)

[Cannot Receive Faxes with a Telephone Connected to Your Product](#)

Parent topic: [Solving Problems](#)

Cannot Send or Receive Faxes

If you cannot send or receive faxes, try these solutions:

- Make sure the recipient's fax machine is turned on and working.
- Make sure paper is loaded correctly in your product.
- Make sure **Auto Answer** mode is turned on to receive faxes automatically. Check your product control panel to see if this mode is turned on.
- Check that the cable connecting your telephone wall jack to your product's **LINE** port is secure.
- Print a fax connection report using your product control panel or fax software to help diagnose the problem.
- Verify that the telephone wall jack works by connecting a phone to it and testing it.
- If you connected your product to a DSL phone line, you must connect a DSL filter to the phone jack to enable faxing over the line. Contact your DSL provider for the necessary filter.
- If your telephone line has static, turn off your product's **V.34** and **ECM** (Error Correction Mode) fax communication settings and try faxing again.

Note: If your product is connected to a VoIP (Voice over Internet Protocol) phone line, keep in mind that fax machines are designed to work over analog phone lines. Epson cannot guarantee that fax transmission will work when using VoIP.

If your phone line includes voice mail answering services, calls or faxes may be inadvertently received by your voice mail service.

Parent topic: [Solving Faxing Problems](#)

Related tasks

[Receiving Faxes Automatically \(Auto Answer\)](#)

[Connecting a Telephone or Answering Machine](#)

[Printing Fax Reports](#)

[Selecting Fax Communication Settings](#)

Related topics

[Loading Paper](#)

Cannot Receive Faxes with a Telephone Connected to Your Product

Make sure your telephone is connected to your product's **EXT** port.

Note: When answering a call that is a fax, wait until the product's LCD screen displays a message that a connection has been made before you hang up.

Parent topic: [Solving Faxing Problems](#)

Related tasks

[Connecting a Telephone or Answering Machine](#)

When to Uninstall Your Product Software

If you have a problem that requires you to uninstall and re-install your software, follow the instructions for your operating system.

[Uninstalling Product Software - Windows](#)

[Uninstalling Product Software - Mac OS X](#)

Parent topic: [Solving Problems](#)

Uninstalling Product Software - Windows

You can uninstall and then re-install your product software to solve certain problems.

1. Turn off the product.
2. Disconnect any interface cables.
3. Click  or **Start**, and select **All Programs** or **Programs**.
4. Select **EPSON**, select your product, then click **EPSON Printer Software Uninstall**.

Note: If you see a **User Account Control** window, click **Yes** or **Continue**.

5. In the next window, select your product and click **OK**. Then follow any on-screen instructions.

6. Open the Windows **Control Panel** utility.
7. Do one of the following to uninstall EPSON Event Manager, then follow any on-screen instructions:
 - **Windows 7 or Windows Vista:** Select **Programs and Features**. (In Classic view, select **Programs** and click **Uninstall a program**.) Select **Epson Event Manager** and click **Uninstall/Change**.
 - **Windows XP:** Double-click **Add or Remove Programs**. Select **Epson Event Manager** and click **Change/Remove**.
8. Do one of the following to uninstall EPSON Scan, then follow any on-screen instructions:
 - **Windows 7 or Windows Vista:** Select **EPSON Scan** and click **Uninstall/Change**.
 - **Windows XP:** Select **EPSON Scan** and click **Change/Remove**.
9. Restart your computer, then see the *Start Here* sheet to re-install your software.

Note: If you find that re-installing your product software does not solve a problem, contact Epson.

Parent topic: [When to Uninstall Your Product Software](#)

Uninstalling Product Software - Mac OS X

In most cases, you do not need to uninstall your product software before re-installing it. However, you can download the Uninstall Center utility from the Epson support website to uninstall your product software as described here.

Note: If you find that re-installing your product software does not solve a problem, contact Epson.

1. To download the Uninstall Center utility, visit the Epson download site ([U.S. downloads](#) or [Canadian downloads](#)).
2. Follow the instructions on the screen to install the Uninstall Center.
3. Quit all applications currently running on your Mac.
4. Double-click the **Uninstall Center** icon.
5. Select the checkbox for each software program you want to uninstall.
6. Click **Uninstall**.
7. Follow the on-screen instructions to uninstall the software.
8. To reinstall your product software, see the *Start Here* sheet for instructions.

Note: If you uninstall the printer driver and your product name remains in the Print & Fax or Print & Scan window, select your product name and click the – (remove) icon to remove it.

Parent topic: [When to Uninstall Your Product Software](#)

Where to Get Help

If you need to contact Epson for technical support services, use the following support options.

Internet Support

Visit Epson's support website at www.epson.com/support (U.S.) or www.epson.ca/support (Canada) for solutions to common problems. You can download drivers and documentation, get FAQs and troubleshooting advice, or e-mail Epson with your questions.

Speak to a Support Representative

Before you call Epson for support, please have the following information ready:

- Product name
- Product serial number (located on a label on the product)
- Proof of purchase (such as a store receipt) and date of purchase
- Computer configuration
- Description of the problem

Then call:

- U.S.: (562) 276-4382, 6 AM to 8 PM, Pacific Time, Monday through Friday, and 7 AM to 4 PM, Pacific Time, Saturday
- Canada: (905) 709-3839, 6 AM to 8 PM, Pacific Time, Monday through Friday

Days and hours of support are subject to change without notice. Toll or long distance charges may apply.

Purchase Supplies and Accessories

You can purchase genuine EPSON ink and paper at EPSON Supplies Central at www.epson.com/ink3 (U.S. sales) or www.epson.ca (Canadian sales). You can also purchase supplies from an EPSON authorized reseller. To find the nearest one, call 800-GO-EPSON (800-463-7766).

Parent topic: [Solving Problems](#)

Technical Specifications

These sections list the technical specifications for your product.

Note: Epson offers a recycling program for end of life products. Please go to www.epson.com/recycle for information on how to return your products for proper disposal.

[Windows System Requirements](#)

[Mac System Requirements](#)

[Printing Specifications](#)

[Scanning Specifications](#)

[Automatic Document Feeder \(ADF\) Specifications](#)

[Fax Specifications](#)

[Paper Specifications](#)

[Printable Area Specifications](#)

[Ink Cartridge Specifications](#)

[Dimension Specifications](#)

[Electrical Specifications](#)

[Environmental Specifications](#)

[Interface Specifications](#)

[External USB Device Specifications](#)

[Network Interface Specifications](#)

[Safety and Approvals Specifications](#)

Windows System Requirements

To use your product and its software, your computer should use one of these operating systems:

- Microsoft Windows 7
- Windows Vista
- Windows XP Professional x64 Edition
- Windows XP SP1 or higher

Note: Visit Epson's support website at www.epson.com/support (U.S.) or www.epson.ca/support (Canada) for the latest in compatibility and drivers for your product.

Parent topic: [Technical Specifications](#)

Mac System Requirements

To use your product and its software, your Mac should use one of these operating systems:

- Mac OS X 10.4.11
- Mac OS X 10.5.8
- Mac OS X 10.6.x
- Mac OS X 10.7.x

Note: Visit Epson's support website at www.epson.com/support (U.S.) or www.epson.ca/support (Canada) for the latest in compatibility and drivers for your product.

Parent topic: [Technical Specifications](#)

Printing Specifications

Paper path	Paper cassette, front entry
Paper cassette capacity	Approximately 250 sheets at 17 to 24 lb (75 to 90 g/m ²)

Parent topic: [Technical Specifications](#)

Scanning Specifications

Scanner type	Flatbed, color
Photoelectric device	CIS
Effective pixels	20,400 × 20,080 pixels at 2400 dpi
Document size	Maximum: 8.5 × 11.7 inches (216 × 297 mm) Scanner glass: US letter or A4
Scanning resolution	2400 dpi (main scan) 2400 dpi (sub scan)
Output resolution	50 to 4800, 7200, and 9600 dpi (50 to 4800 dpi in 1 dpi increments)

Image data	16 bits per pixel per color internal 8 bits per pixel per color external
Light source	LED

Parent topic: [Technical Specifications](#)

Automatic Document Feeder (ADF) Specifications

Paper input	Faceup loading
Paper output	Facedown ejection
Paper size	US letter, legal, or A4 size
Paper type	Plain paper
Paper weight	17 lb (64 g/m ²) to 24 lb (95 g/m ²)
Sheet feeding capacity	Total thickness: 0.12 inch (3 mm) Approximately 30 sheets (US letter or A4) or 10 sheets (legal)

Parent topic: [Technical Specifications](#)

Fax Specifications

Fax type	Black-and-white and color fax capability
Support line	Household phone line
Speed	Up to 33.6 kbps
Resolution	Monochrome: Standard: 203 × 98 dpi Fine: 203 × 196 dpi Photo: 203 × 196 dpi Color: Fine: 200 × 200 dpi Photo: 200 × 200 dpi

Error correction mode	CCITU/ITU Group 3 fax with error correction mode
Speed dial/group dial numbers	Up to 60 (combined)
Page memory	Up to 180 (ITU-T No. 1 chart)
Redial	2 times (with 1 minute interval)
Interface	RJ-11 Phone Line RJ-11 Telephone set connection

Parent topic: [Technical Specifications](#)

Paper Specifications

Use paper under normal conditions:

- Temperature: 59 to 77 °F (15 to 25 °C)
- Humidity: 40 to 60% RH

Note: Since the quality of any particular brand or type of paper may be changed by the manufacturer at any time, Epson cannot guarantee the quality of any non-EPSON brand or type of paper. Always test a sample of paper stock before purchasing large quantities or printing large jobs.

Single-sheets

Size	A4 (8.3 × 11.7 inches [210 × 297 mm]) A6 (4.1 × 5.8 inches [105 × 148 mm]) Letter (8.5 × 11 inches [216 × 279 mm]) Legal (8.5 × 14 inches [216 × 357 mm]) 4 × 6 inches (102 × 152 mm) 5 × 7 inches (127 × 178 mm) 8 × 10 inches (203 × 254 mm) 16:9 wide (4 × 7.1 inches [102 × 181 mm])
Paper types	Plain paper and paper distributed by Epson
Thickness	0.003 to 0.004 inch (0.08 to 0.11 mm)
Weight	17 lb (64 g/m ²) to 24 lb (90 g/m ²)

Envelopes

Size	No. 10 (4.1 × 9.5 inches [105 × 241 mm])
Paper types	Plain paper
Weight	20 lb (75 g/m ²) to 24 lb (90 g/m ²)

Parent topic: [Technical Specifications](#)

Printable Area Specifications

Single sheets

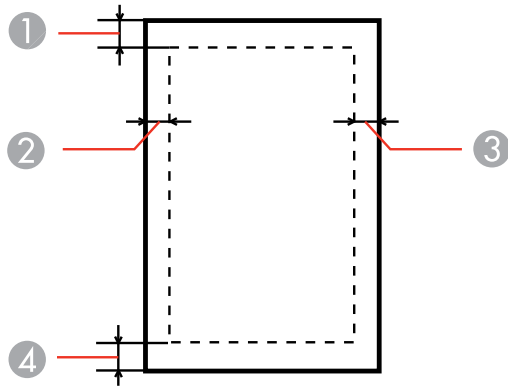

- 1 Top: 0.12 inch (3 mm) minimum
- 2 Left: 0.12 inch (3 mm) minimum
- 3 Right: 0.12 inch (3 mm) minimum
- 4 Bottom: 0.12 inch (3 mm) minimum

Envelopes

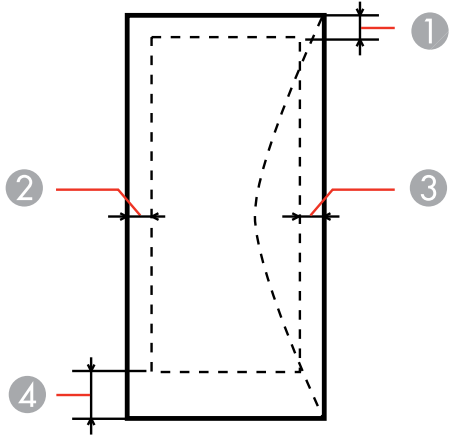

- 1 Left: 0.12 inch (3 mm) minimum
- 2 Bottom: 0.20 inch (5 mm) minimum
- 3 Top: 0.20 inch (5 mm) minimum
- 4 Right: 0.78 inch (20 mm) minimum

Parent topic: [Technical Specifications](#)

Ink Cartridge Specifications

Note: We recommend that you use genuine EPSON maintenance boxes and cartridges and do not refill them. The use of other products may affect your print quality and could result in printer damage.

Part of the ink from the included set of cartridges is used for priming the printer. Yields vary considerably based on images printed, print settings, paper type, frequency of use, and temperature. For print quality, a variable amount of ink remains in the cartridge after the "replace cartridge" indicator comes on.

Color

Black, Cyan, Magenta, Yellow

Cartridge life

Opened package: 6 months

Unopened package: do not use if the date on the package has expired

Temperature	Storage: -4 to 104 °F (-20 to 40 °C)
	1 month at 104 °F (40 °C)
	Ink freezes at 10.4 °F (-12 °C)
	Ink thaws and is usable after 3 hours at 77 °F (25 °C)

Note: For best printing results, use up a cartridge within 6 months of opening the package.

Parent topic: [Technical Specifications](#)

Dimension Specifications

Height	Stored: 11.8 inches (300 mm)
	Printing: 12.3 inches (312 mm)
Width	Stored: 17.6 inches (446 mm)
	Printing: 17.6 inches (446 mm)
Depth	Stored: 14.5 inches (368 mm)
	Printing: 22.3 inches (566 mm)
Weight (without ink cartridges)	21.6 lb (9.8 kg)

Parent topic: [Technical Specifications](#)

Electrical Specifications

Power supply rating	100 to 120 V
Input voltage range	90 to 264 V
Rated frequency range	50/60 Hz
Input frequency range	49.5/60.5 Hz
Rated current	0.6/0.3 A

Power consumption (Approximate)	Standalone copying mode: 17 W (ISO/IEC24712)
	Ready mode: 7.5 W
	Sleep mode: 3.9 W
	Power off mode: 0.2 W

Parent topic: [Technical Specifications](#)

Environmental Specifications

Temperature	Operating: 50 to 95 °F (10 to 35 °C)
	Storage: -4 to 104 °F (-20 to 40 °C)
	1 month at 104 °F (40 °C)
Humidity (non-condensing)	Operating: 20 to 80% RH
	Storage: 5 to 85% RH

Parent topic: [Technical Specifications](#)

Interface Specifications

Interface type	Hi-Speed USB (Device class for computers)
	Hi-Speed USB (Mass storage class for external storage)

Note: Epson cannot guarantee the operation of externally connected devices.

Parent topic: [Technical Specifications](#)

External USB Device Specifications

Note: Use only external storage devices with independent AC power sources. External storage devices that are powered via USB are not recommended.

Magneto-optical drive	1.3GB
------------------------------	-------

Hard disk and USB flash drives 2TB
Formatted in FAT, FAT32, or exFAT.

Parent topic: [Technical Specifications](#)

Network Interface Specifications

Wireless LAN standard IEEE 802.11 b/g/n
Wireless security WPA-PSK (TKIP/AES) WPA2 compliant
WEP (64/128 bit)
Frequency band 2.4 GHz
Communication mode Infrastructure mode
Ad hoc mode
Ethernet standard 100 BASE-TX/10BASE-T

Note: Wireless LAN standard complies with either IEEE 802.11 b/g or IEEE 802.11 b/g/n, depending on purchase location.

Parent topic: [Technical Specifications](#)

Safety and Approvals Specifications

United States Safety: UL60950-1
EMC: FCC part 15 Subpart B class B
Canada Safety: CAN/CSA C22.2 No. 60950-1
EMC: CAN/CSA-CEI/IEC CISPR 22 Class B

This equipment contains the following wireless module:

- Manufacturer: Marvell Semiconductor Inc.
- Type: SP88W8786-MD0-2C2T00

This product conforms to Part 15 of FCC Rules and RSS-210 of the IC Rules. Epson cannot accept responsibility for any failure to satisfy the protection requirements resulting from a non-recommended

modification of the product. Operation is subject to the following two conditions: (1) this device may not cause harmful interference, and (2) this device must accept any interference received, including interference that may cause undesired operation of the device.

To prevent radio interference to the licensed service, this device is intended to be operated indoors and away from windows to provide maximum shielding. Equipment (or its transmit antenna) that is installed outdoors is subject to licensing.

Parent topic: [Technical Specifications](#)

Notices

Check these sections for important notices about your product.

Note: Epson offers a recycling program for end of life products. Please go to www.epson.com/recycle for information on how to return your products for proper disposal.

[FCC Compliance Statement](#)

[Software Notices](#)

[Trademarks](#)

[Copyright Notice](#)

FCC Compliance Statement

For United States Users

This equipment complies with Part 68 of the FCC rules and the requirements adopted by the ACTA. On the back side is a label that contains, among other information, the FCC registration number and the ringer equivalence number (REN) for this equipment. You must, upon request, provide this information to your local telephone company. The information associated with the services the equipment is to be connected are REN: 0.1B, Jack type: RJ-11C.

The REN is useful to determine the quantity of devices that you may connect to your telephone line and still have all of those devices ring when your telephone number is called. In most, but not all areas, the sum of the RENs of all devices connected to one line should not exceed five (5.0). To be certain of the number of devices that you may connect to your line, you may want to contact your local telephone company to determine the maximum REN for your calling area. For products approved after July 23, 2001, the REN for this product is part of the product identifier that has the format US: BKMFA01BC423A. The digits represented by 01B are the REN without a decimal point (e.g., 01B is a REN of 0.1B). For earlier products, the REN is separately shown on the label.

This equipment may not be used on coin service provided by the telephone company. Connection to party lines is subject to state tariffs.

Should this equipment cause harm to the telephone network, the telephone company may discontinue your service temporarily. If possible they will notify you in advance that temporary discontinuance of service may be required. But if advanced notice isn't practical, the telephone company will notify you as soon as possible. You will be informed of your right to file a complaint with the FCC. The telephone company may make changes in its facilities, equipment, operations or procedures that could affect the proper functioning of your equipment. If they do, you will be notified in advance to give you an opportunity to maintain uninterrupted telephone service.

This product is not intended to be repaired. If you experience trouble with this equipment, please contact:

Name: Epson America, Inc.

Address: 3840 Kilroy Airport Way, Long Beach, CA 90806 U.S.A.

Telephone: (562) 981-3840

The telephone company may ask that you disconnect this equipment from the network until the problem has been corrected or until you are sure that the equipment is not malfunctioning.

A plug and jack used to connect this equipment to the premises wiring and telephone network must comply with the applicable FCC Part 68 rules and requirements adopted by the ACTA. A compliant telephone cord and modular plug is provided with this product. It is designed to be connected to a compatible modular jack that is also compliant. See installation instructions for details.

The Telephone Consumer Protection Act of 1991 makes it unlawful for any person to use a computer or other electronic device, including fax machines, to send any message unless such message clearly contains in a margin at the top or bottom of each transmitted page or on the first page of the transmission, the date and time it is sent and an identification of the business or other entity, or other individual sending the message and the telephone number of the sending machine or such business, other entity, or individual. In order to program this information into your fax machine, follow the instructions for entering fax header information.

According to the FCC's electrical safety advisory, we recommend that you may install an AC surge arrester in the AC outlet to which this equipment is connected. Telephone companies report that electrical surges, typically lightning transients, are very destructive to customer terminal equipment connected to AC power sources and that this is a major nationwide problem.

If your home has specially wired alarm equipment connected to the telephone line, ensure the installation of this equipment Model C423A does not disable your alarm equipment. If you have questions about what will disable alarm equipment, consult your telephone company or a qualified installer.

This equipment has been tested and found to comply with the limits for a Class B digital device, pursuant to Part 15 of the FCC Rules. These limits are designed to provide reasonable protection against harmful interference in a residential installation. This equipment generates, uses, and can radiate radio frequency energy and, if not installed and used in accordance with the instructions, may cause harmful interference to radio or television reception. However, there is no guarantee that interference will not occur in a particular installation. If this equipment does cause interference to radio and television reception, which can be determined by turning the equipment off and on, the user is encouraged to try to correct the interference by one or more of the following measures:

- Reorient or relocate the receiving antenna.
- Increase the separation between the equipment and receiver.

- Connect the equipment into an outlet on a circuit different from that to which the receiver is connected.
- Consult the dealer or an experienced radio/TV technician for help.

WARNING

The connection of a non-shielded equipment interface cable to this equipment will invalidate the FCC Certification or Declaration of this device and may cause interference levels which exceed the limits established by the FCC for this equipment. It is the responsibility of the user to obtain and use a shielded equipment interface cable with this device. If this equipment has more than one interface connector, do not leave cables connected to unused interfaces. Changes or modifications not expressly approved by the manufacturer could void the user's authority to operate the equipment.

For Canadian Users

1. This product meets the applicable Industry Canada technical specifications.
2. The Ringer Equivalence Number is an indication of the maximum number of devices allowed to be connected to a telephone interface. The termination on an interface may consist of any combination of devices subject only to the requirement that the sum of the RENs of all the devices does not exceed five.

This Class B digital apparatus complies with Canadian ICES-003.

Le présent matériel est conforme aux spécifications techniques applicables d'Industrie Canada.

L'indice d'équivalence de la sonnerie (IES) sert à indiquer le nombre maximal de terminaux qui peuvent être raccordés à une interface téléphonique. La terminaison d'une interface peut consister en une combinaison quelconque de dispositifs, à la seule condition que la somme d'indices d'équivalence de la sonnerie de tous les dispositifs n'excède pas 5.

Cet appareil numérique de la classe B est conforme à la norme NMB-003 du Canada.

Parent topic: [Notices](#)

Software Notices

OPEN SOURCE SOFTWARE LICENSE

1. This printer product includes open source software programs listed in Section 6) according to the license terms of each open source software program.
2. We provide the source code of the GPL Programs, LGPL Programs and Apple Public Source License Programs (each is defined in Section 6) until five (5) years after the discontinuation of same model of this printer product. If you desire to receive the source code above, please see the "Contacting Customer Support" in Appendix or Printing Guide of this User's Guide, and contact the customer support of your region. You shall comply with the license terms of each open source software program.

3. The open source software programs are WITHOUT ANY WARRANTY; without even the implied warranty of MERCHANTABILITY AND FITNESS FOR A PARTICULAR PURPOSE. See the license agreements of each open source software program for more details, which are described in OSS.pdf on your Printer Software CD.
4. OpenSSL toolkit
This printer product includes software developed by the OpenSSL project for use in the OpenSSL Toolkit (<http://www.openssl.org/>).
This product includes cryptographic software written by Eric Young (eay@cryptsoft.com).
5. The license terms of each open source software program are described in OSS.pdf on your Printer Software CD.
6. The list of open source software programs which this printer product includes are as follows.

GNU GPL

This printer product includes the open source software programs which apply the GNU General Public License Version 2 or later version ("GPL Programs").

The list of GPL Programs:

base-passwd-3.5.7

busybox-1.2.2.1

ifupdown-0.6.8

kernel-2.6.18

lsp-arm-versatile926ejs-2.6.18_pro500

module-init-tools-3.2pre1

mount-2.12

net-tools-1.60

netbase-4.29

psmisc-21.5

readline-libs-5.0

sysvinit-2.86

udev-0.093

udhcp 0.9.8cvs20050124-5

util-linux-2.12

usb8786

GNU LGPL

This printer product includes the open source software programs which apply the GNU Lesser General Public License Version 2 or later version ("LGPL Programs").

The list of LGPL Programs:

uclibc-0.9.29

libusb-libs-0.1.12

zeroconf 0.6.1-1

Apple Public Source License

This printer product includes the open source software programs which apply the Apple Public Source License Version 1.2 or its latest version ("Apple Public Source License Programs").

Apple Public Source License Programs:

Bonjour

Net-SNMP license

This printer product includes the open source software program "Net-SNMP" which applies the terms and conditions provided by owner of the copyright to the "Net-SNMP".

OpenSSL License/Original SSLeay License

This printer product includes the open source software program "OpenSSL toolkit" which applies the license terms of OpenSSL License and Original SSLeay License.

BSD License (Berkeley Software Distribution License)

This printer product includes the open source software programs which apply the Berkeley Software Distribution License ("BSD Programs").

The list of BSD Programs:

busybox-1.2.2.1

util-linux-2.12

mount-2.12

mvnutils-2.8.4

netkit-ftp-0.17

netkit-base-0.17

portmap-5beta

Sun RPC License

This printer product includes the open source software programs which apply the Sun RPC License ("Sun RPC Programs").

The list of Sun RPC Programs:

busybox- 1 .2.2.1

netkit-inetd-0.17

portmap-5beta

TCP Wrappers license

This printer product includes the open source software program "TCP Wrappers" which applies the terms and conditions provided by owner of the copyright to the "TCP Wrappers".

"TCP Wrappers" Program:

libwrap-libs-7.6

libncurses license

This printer product includes the open source software program "libncurses" which applies the terms and conditions provided by owner of the copyright to the "libncurses".

"libncurses" Program :

libncurses-5.4

linux-ftpd license

This printer product includes the open source software program "linux-ftpd" which applies the terms and conditions provided by owner of the copyright to the "linux-ftpd".

"linux-ftpd" Program:

linux-ftpd-0.17

ARC4 license

This printer product includes the open source software program "ARC4" which applies the terms and conditions provided by owner of the copyright to the "ARC4".

"ARC4" Program:

ARC4

SHA1license

This printer product includes the open source software program "SHA1" which applies the terms and conditions provided by owner of the copyright to the "AES".

"SHA1" Program:

SHA1

Parent topic: [Notices](#)

Trademarks

EPSON®, WorkForce®, and EPSON Supplies Central® are registered trademarks, and EPSON Exceed Your Vision is a registered logomark of Seiko Epson Corporation.

EPSON StoreSM is a service mark of Epson America, Inc.

General Notice: Other product names used herein are for identification purposes only and may be trademarks of their respective owners. Epson disclaims any and all rights in those marks.



Parent topic: [Notices](#)

Copyright Notice

All rights reserved. No part of this publication may be reproduced, stored in a retrieval system, or transmitted in any form or by any means, electronic, mechanical, photocopying, recording, or otherwise, without the prior written permission of Seiko Epson Corporation. The information contained herein is designed only for use with this EPSON product. Epson is not responsible for any use of this information as applied to other products.

Neither Seiko Epson Corporation nor its affiliates shall be liable to the purchaser of this product or third parties for damages, losses, costs, or expenses incurred by purchaser or third parties as a result of: accident, misuse, or abuse of this product or unauthorized modifications, repairs, or alterations to this product, or (excluding the U.S.) failure to strictly comply with Seiko Epson Corporation's operating and maintenance instructions.

Seiko Epson Corporation shall not be liable for any damages or problems arising from the use of any options or any consumable products other than those designated as Original EPSON Products or EPSON Approved Products by Seiko Epson Corporation.

Seiko Epson Corporation shall not be held liable for any damage resulting from electromagnetic interference that occurs from the use of any interface cables other than those designated as EPSON approved Products by Seiko Epson Corporation.

This information is subject to change without notice.

[libTIFF Software Acknowledgment](#)

[A Note Concerning Responsible Use of Copyrighted Materials](#)

[Default Delay Times for Power Management for EPSON Products](#)

[Copyright Attribution](#)

Parent topic: [Notices](#)

libTIFF Software Acknowledgment

Copyright © 1988-1997 Sam Leffler

Copyright © 1991-1997 Silicon Graphics, Inc.

Permission to use, copy, modify, distribute, and sell this software and its documentation for any purpose is hereby granted without fee, provided that (i) the above copyright notices and this permission notice appear in all copies of the software and related documentation, and (ii) the names of Sam Leffler and Silicon Graphics may not be used in any advertising or publicity relating to the software without the specific, prior written permission of Sam Leffler and Silicon Graphics.

THE SOFTWARE IS PROVIDED "AS-IS" AND WITHOUT WARRANTY OF ANY KIND, EXPRESS, IMPLIED OR OTHERWISE, INCLUDING WITHOUT LIMITATION, ANY WARRANTY OF MERCHANTABILITY OR FITNESS FOR A PARTICULAR PURPOSE.

IN NO EVENT SHALL SAM LEFFLER OR SILICON GRAPHICS BE LIABLE FOR ANY SPECIAL, INCIDENTAL, INDIRECT OR CONSEQUENTIAL DAMAGES OF ANY KIND, OR ANY DAMAGES WHATSOEVER RESULTING FROM LOSS OF USE, DATA OR PROFITS, WHETHER OR NOT ADVISED OF THE POSSIBILITY OF DAMAGE, AND ON ANY THEORY OF LIABILITY, ARISING OUT OF OR IN CONNECTION WITH THE USE OR PERFORMANCE OF THIS SOFTWARE.

Parent topic: [Copyright Notice](#)

A Note Concerning Responsible Use of Copyrighted Materials

Epson encourages each user to be responsible and respectful of the copyright laws when using any EPSON product. While some countries' laws permit limited copying or reuse of copyrighted material in certain circumstances, those circumstances may not be as broad as some people assume. Contact your legal advisor for any questions regarding copyright law.

Parent topic: [Copyright Notice](#)

Default Delay Times for Power Management for EPSON Products

This product will enter sleep mode after a period of nonuse. The time interval has been set at the factory to ensure that the product meets Energy Star standards of energy efficiency, and cannot be modified by the consumer.

Parent topic: [Copyright Notice](#)

Copyright Attribution

© 2012 Epson America, Inc.

3/12

CPD-34337R2

Parent topic: [Copyright Notice](#)