

ChromaBlastTM

v1.0

Getting Started Guide

For EPSON Stylus[®] C120/C110

ChromaBlast™ Getting Started Guide for the EPSON Stylus® C120/C110

© Copyright 2008, Sawgrass Technologies, Inc., Revision April 2008. All rights reserved. Printed in the United States of America.

ChromaBlast™, ChromaBlast™ inks, ChromaBlast Driver™, and ColorSure™ are trademarks of Sawgrass Technologies, Inc.

Other trademarks and registered trademarks are the property of their respective owners.

No part of this manual may be reproduced or transmitted in any form by any means without the prior written consent of Sawgrass Technologies, Inc. Information in this manual is subject to change without notice and does not represent a commitment on the part of Sawgrass Technologies, Inc.

IMPORTANT – READ CAREFULLY:

This product is for commercial use only.

This Process License Agreement ("PLA") is a legal agreement between you and Sawgrass Technologies, Inc. ("Sawgrass"). By installing the ChromaBlast™ cartridge in your printer, or otherwise using the Sawgrass ChromaBlast™ ink, you agree to be bound by the terms of this PLA. If you do not agree to the terms of this PLA, Sawgrass is unwilling to license the process of using the ChromaBlast™ ink to you. In such event, you may not use the ChromaBlast™ ink, and you should promptly contact your supplier for instructions on return of the unopened package.

The process of using ChromaBlast™ ink is protected by U.S. and foreign patents. Sawgrass will provide a complete list of the relevant patents upon request. The use of the ChromaBlast™ ink to practice the patented process is permitted by this license.

1. GRANT OF LICENSE This PLA grants you the following rights:

You may install and use the ChromaBlast™ ink packaged herewith in your EPSON printer to practice the printing process described in U.S. Patent No. 6,341,856 ("Sawgrass Process"). The use of any ink, dye or pigment to practice the Sawgrass Process, other than a ChromaBlast™ ink purchased from Sawgrass or its authorized distributor accompanied by a PLA, is not a licensed use of the Sawgrass Process. No rights to use the Sawgrass Process, except those specified herein, are granted, and no rights to use any other process, product, software or hardware developed or sold by Sawgrass are granted or implied hereby.

2. LIMITATIONS ON REVERSE ENGINEERING

You agree that you will not attempt to reverse engineer, reproduce or reformulate the ChromaBlast™ ink.

3. PATENTS AND COPYRIGHTS

Sawgrass owns multiple U.S. and foreign patents which may apply to the Sawgrass Process and/or the use of ChromaBlast™ ink. All patents in and to the method of using ChromaBlast™ ink are owned by Sawgrass Technologies, Inc. You may not copy the printed materials accompanying the ChromaBlast™ ink. All rights not specifically granted under this PLA are reserved by Sawgrass Technologies, Inc.

Sawgrass agrees to replace any defective product, or to refund the purchase price, within a reasonable time, which shall be Sawgrass' sole responsibility for errors or defects in the goods. THERE ARE NO OTHER WARRANTIES, EXPRESSED OR IMPLIED, INCLUDING, BUT NOT LIMITED TO, ANY IMPLIED WARRANTY OF MERCHANTABILITY OR FITNESS FOR A PARTICULAR PURPOSE. SAWGRASS SHALL NOT BE LIABLE FOR LOSS OF PROFIT OR OTHER ECONOMIC LOSS, OR FOR INDIRECT, SPECIAL, CONSEQUENTIAL OR OTHER SIMILAR DAMAGES.

IMPORTANT – READ CAREFULLY:

This product is for commercial use only.

This Process License Agreement ("PLA") is a legal agreement between you and Sawgrass Technologies, Inc. ("Sawgrass"). By installing the ChromaBlast™ media in your printer, or otherwise using the Sawgrass ChromaBlast™ media, you agree to be bound by the terms of this PLA. If you do not agree to the terms of this PLA, Sawgrass is unwilling to license the process of using the ChromaBlast™ media to you. In such event, you may not use the ChromaBlast™ media, and you should promptly contact your supplier for instructions on return of the unopened package.

The process of using ChromaBlast™ media is protected by U.S. and foreign patents. Sawgrass will provide a complete list of the relevant patents upon request. The use of the ChromaBlast™ media to practice the patented process is permitted by this license.

1. GRANT OF LICENSE This PLA grants you the following rights:

You may use the ChromaBlast™ media packaged herewith with your ChromaBlast™ ink in your Epson printer to practice the printing process described in U.S. Patent No. **6,341,856** ("Sawgrass Process"). The use of any ink, dye or pigment and media combination to practice the Sawgrass Process, other than ChromaBlast™ ink and ChromaBlast™ media purchased from Sawgrass or its authorized distributor accompanied by a PLA, is not a licensed use of the Sawgrass Process. No rights to use the Sawgrass Process, except those specified herein, are granted, and no rights to use any other process, product, software or hardware developed or sold by Sawgrass are granted or implied hereby.

2. LIMITATIONS ON REVERSE ENGINEERING

You agree that you will not attempt to reverse engineer, reproduce or reformulate the ChromaBlast™ media or ink.

3. PATENTS AND COPYRIGHTS

Sawgrass owns multiple U.S. and foreign patents which may apply to the Sawgrass Transfer Media Process and/or the use of ChromaBlast™ media. All patents in and to the method of using ChromaBlast™ media are owned by Sawgrass Technologies, Inc. You may not copy the printed materials accompanying the ChromaBlast™ media. All rights not specifically granted under this PLA are reserved by Sawgrass Technologies, Inc.

END-USER LICENSE AGREEMENT FOR SAWGRASS SOFTWARE- ChromaBlast Driver™

IMPORTANT-READ CAREFULLY: This Sawgrass Technologies Inc. End-User License Agreement ("EULA") is a legal agreement between you (either an individual or a single entity) and Sawgrass Technologies, Inc for the Sawgrass software product identified above, which includes computer software and may include associated media, printed materials, and "online" or electronic documentation ("SOFTWARE PRODUCT"). By installing, copying, or otherwise using the SOFTWARE PRODUCT, you agree to be bound by the terms of this EULA. If you do not agree to the terms of this EULA, do not install or use the SOFTWARE PRODUCT.

Software PRODUCT LICENSE

Copyright laws and international copyright treaties, as well as other intellectual property laws and treaties protect the SOFTWARE PRODUCT. The SOFTWARE PRODUCT is licensed, not sold. The title to, and ownership of, this SOFTWARE PRODUCT remains with Sawgrass Technologies, Inc. (Sawgrass).

GRANT OF LICENSE. This EULA grants you the following rights:

- This license is provided to you for your use according to the terms hereof. You may install and use the SOFTWARE PRODUCT packaged herewith to practice the printing process described in U.S. Patent No. 6,341,856 (the "Sawgrass Process"). The use of any ink, dye or pigment to practice the Sawgrass Process, other than a ChromaBlast™ ink which is purchased from Sawgrass or its authorized distributor, is not a licensed use of the SOFTWARE PRODUCT. You agree not to use the SOFTWARE PRODUCT for any other purpose or in any process except as expressly permitted hereby.
- Not for Resale. You may not sell, or otherwise transfer for value, the SOFTWARE PRODUCT.
- No Reverse Engineering, Decompilation, Copying or Disassembly. You may not reverse engineer, decompile, copy or disassemble the SOFTWARE PRODUCT.
- No Rental. You may not rent, lease, or lend the SOFTWARE PRODUCT.
- Support Services. Sawgrass Technologies, Inc. may provide you with support services related to the SOFTWARE PRODUCT ("Support Services"). Use of Support Services is governed by the Sawgrass policies and programs described in the user manual, in "online" documentation, and/or in other Sawgrass-provided materials. Any supplemental software code provided to you as part of the Support Services shall be considered part of the SOFTWARE PRODUCT and subject to the terms and conditions of this EULA. With respect to technical information you provide to Sawgrass as part of the Support Services, Sawgrass may use such information for its business purposes, including for product support and development. Sawgrass will not utilize such technical information in a form that personally identifies you.
- No Assignment or Sublicense. You may not assign or sublicense the rights granted hereby.
- Termination. Without prejudice to any other rights, Sawgrass may terminate this EULA if you fail to comply with the terms and conditions of this EULA. In the event of termination, you must destroy all copies of the SOFTWARE PRODUCT and all of its component parts.

COPYRIGHT. All title and copyrights in and to the SOFTWARE PRODUCT (including but not limited to any images, photographs, animations, video, audio, music, text, and "applets" incorporated into the SOFTWARE PRODUCT), the accompanying printed materials, and any copies of the SOFTWARE PRODUCT are owned by Sawgrass Technologies Inc. or its suppliers. Copyright laws and international treaty provisions protect the SOFTWARE PRODUCT. Therefore, you must treat the SOFTWARE PRODUCT like any other copyrighted material, except that you may install the

SOFTWARE PRODUCT on a computer for the uses permitted hereby. You may not copy the printed materials accompanying the SOFTWARE PRODUCT. You may not loan, rent, lease, or otherwise transfer the other medium to another user, except as part of the permanent transfer (as provided above) of the SOFTWARE PRODUCT.

U.S. GOVERNMENT RESTRICTED RIGHTS. The SOFTWARE PRODUCT and documentation are provided with RESTRICTED RIGHTS. Use, duplication, or disclosure by the Government is subject to restrictions as set forth in subparagraph (c)(1)(ii) of the Rights in Technical Data and Computer Software clause at DFARS 252.227-7013 or subparagraphs (c)(1) and (2) of the Commercial Computer Software-Restricted Rights at 48 CFR 52.227-19, as applicable.

MISCELLANEOUS

a. If you acquired this product in the United States, this EULA is governed by the laws of the State of South Carolina. In the event of any dispute arising under this license or from the use of the SOFTWARE PRODUCT, each party irrevocably agrees to the jurisdiction of the United States District Court for the District of South Carolina, Charleston Division.

b. If you acquired this product in Canada, this EULA is governed by the laws of the Province of Ontario, Canada. In the event of any dispute arising under this license or from the use of the SOFTWARE PRODUCT, each party irrevocably agrees to the jurisdiction of the courts of the Province of Ontario and further agrees to commence any litigation which may arise hereunder in the courts located in the Judicial District of York, Province of Ontario.

c. If this product was acquired outside the United States, then local law may apply.

LIMITED WARRANTY. Sawgrass warrants that (a) the SOFTWARE PRODUCT will perform substantially in accordance with the accompanying written materials for a period of thirty (30) days from the date of receipt, and (b) any Support Services provided by Sawgrass shall be substantially as described in applicable written materials provided to you by Sawgrass, and Sawgrass support engineers will make commercially reasonable efforts to solve any problem issues. Some states and jurisdictions do not allow limitations on duration of an implied warranty, so the above limitation may not apply to you. To the extent allowed by applicable law, implied warranties on the SOFTWARE PRODUCT, if any, are limited to thirty (30) days.

CUSTOMER REMEDIES. Sawgrass' and its suppliers' entire liability and your exclusive remedy shall be, at Sawgrass' option, either (a) return of the price paid, if any, or (b) repair or replacement of the SOFTWARE PRODUCT that does not meet Sawgrass' Limited Warranty and which is returned to Sawgrass with a copy of your receipt. This Limited Warranty is void if failure of the SOFTWARE PRODUCT has resulted from accident, abuse, or misapplication. Any replacement SOFTWARE PRODUCT will be warranted for the remainder of the original warranty period or thirty (30) days, whichever is longer. Outside the United States, neither these remedies nor any product support services offered by Sawgrass are available without proof of purchase from an authorized international source.

NO OTHER WARRANTIES. To the maximum extent permitted by applicable law, Sawgrass and its suppliers disclaim all other warranties and conditions, either express or implied, including, but not limited to, implied warranties of merchantability, fitness for a particular purpose, title, and non-infringement, with regard to the SOFTWARE PRODUCT, and the provision of or failure to provide Support Services. This limited warranty gives you specific legal rights. You may have others, which vary from state/jurisdiction to state/jurisdiction.

LIMITATION OF LIABILITY. To the maximum extent permitted by applicable law, in no event shall Sawgrass or its suppliers be liable for any special, incidental, indirect, or consequential damages whatsoever (including, without limitation, damages for loss of business profits, business interruption, loss of business information, or any other pecuniary loss) arising out of the use of or inability to use the SOFTWARE PRODUCT or the provision of or failure to provide Support Services, even if Sawgrass has been advised of the possibility of such damages. In any case, Sawgrass' entire liability under any provision of this EULA shall be limited to U.S. \$5.00. Because some states and jurisdictions do not allow the exclusion or limitation of liability, the above limitation may not apply to you.

ChromaBlast™ ink, ChromaBlast™ media, ChromaBlast Driver™, Quick Connect II™, and Color Sure™ are trademarks of Sawgrass Technologies, Inc.

General Notice: Other product names used herein are for identification purposes only and may be trademarks of their respective owners. Sawgrass Technologies, Inc. disclaims any and all rights in those marks.

Sawgrass Technologies, Inc. Limited Warranty – QuickConnect II™ System

What Is Covered:

Defects in materials or workmanship.

Length of Warranty Coverage:

The warranty coverage for the QuickConnect is **one year from date of purchase**. Any QuickConnect not purchased from Authorized Sawgrass Resellers is not covered.

How to get service:

Please contact Sawgrass Technologies Technical Support at (888) 253-1679 or an Authorized Sawgrass Reseller. A technical support representative will troubleshoot the issue and provide instructions on how to get a replacement if necessary.

What we will do:

Provide you, at the discretion of Sawgrass Technologies, with either replacement parts for your existing Quick Connect unit, a new Quick Connect unit, or a refurbished QuickConnect unit. The exchange is under warranty for the remainder of the original products' warranty period or 90 days, whichever is longer. The replacement will be shipped to you via Ground shipment. Any rush shipments will be freight prepaid.

What your warranty does not cover:

Damage from misuse or neglect.

Damage caused by use outside of Sawgrass Technologies recommendations.

Limitations of Warranty

THERE ARE NO OTHER WARRANTIES, EXPRESSED OR IMPLIED, INCLUDING, BUT NOT LIMITED TO, ANY IMPLIED WARRANTY OF MERCHANTABILITY OR ANY IMPLIED WARRANTY OF FITNESS FOR A PARTICULAR PURPOSE. SAWGRASS SHALL NOT BE LIABLE FOR LOSS OF PROFIT OR OTHER ECONOMIC LOSS, OR FOR INDIRECT, SPECIAL, CONSEQUENTIAL, OR OTHER SIMILAR DAMAGES.

Table of Contents

Introduction	8
About this Document	9
Quick Connect II™ Set-up for the C120/C110	10
Printer Set-up for the C120/C110	11
Chip Reset Instructions	16
Installing ChromaBlast™ Cartridges	18
Replacing an Empty Cartridge	21
Printing and Heat Transfer Instructions	23
ChromaBlast Driver™ Introduction	25
System Requirements.....	25
Setup Instructions – Windows XP / Vista	26
Using ChromaBlast Driver™ in Windows XP / Vista	32
Appendix A: Network Printing in Windows XP / Vista.....	37
Host Machine (Server).....	37
Appendix B: Defeating Application Color Management	38
Appendix C: Using ColorSure™ and Custom Palette	41
Supplies & Equipment	49
Operating Conditions.....	49
Ink Storage.....	49
Media Storage.....	49
Troubleshooting	52
Technical Support	53
Project Cotton.....	53

Introduction

Welcome to Sawgrass Technologies, Inc. and ChromaBlast™. We are excited to offer a total cotton solution for your business. We look forward to working with you and a continued partnership in digital imaging.

The ChromaBlast™ Getting Started Guide contains information for using ChromaBlast™ inks and ChromaBlast media, along with helpful tips for getting the best printing results possible. The information provided pertains only to the use of ChromaBlast™ inks in your printer.

ChromaBlast Driver is included with the ChromaBlast™ system. Developed by Sawgrass Technologies, the ChromaBlast Driver™ is user-friendly software that enables you to maximize output quality and quantity. Please refer to the detailed instructions provided in this manual or on your ChromaBlast Driver™ CD to customize each print.

Technical support is available from your Authorized ChromaBlast™ reseller or directly from Sawgrass Technologies, Inc. See the section entitled *Technical Support* for additional information. Please feel free to contact us with your feedback about our products. For additional information on ChromaBlast™ inks, ChromaBlast™ media, or our other products, visit our web site at www.sawgrassink.com. Thank you and enjoy ChromaBlast™.

About this Document

This document contains descriptions and procedures for using ChromaBlast™ inks, along with additional information on setting up your EPSON Stylus C120/C110 printer and for getting the best results from use of this system.

The documentation provided pertains only to the use of ChromaBlast™ inks in your EPSON Stylus C120/C110 ink jet printer. To assist you in the overall setup process, references are made back to the *EPSON Stylus C120/C110 Printer Basics Guide* for instructions.

To help point out important information, specific instructions, and helpful tips look for the following symbols:



Read This

Indicates **Must-Do** items, including warnings and important guidelines. These must be followed to prevent damage to your printer.



Tip

Indicates useful tips for printing and sublimation.

Quick Connect II™ Set-up for the C120/C110

Check to ensure that you have all of the components necessary to setup your Quick Connect II™ system.

Components

1. Bulk Ink Dampers + tubes
2. Plastic Arm with Velcro adhesive
3. 4 plastic syringes for priming
4. 3 plastic dividers
5. ChromaBlast C120/C110 CD
6. QuickConnect Box
7. ChromaBlast Ink bags(not included with QuickConnect system)
8. Printer



1. Remove the soft protective cap from each ink bag. Depress the metal tab on the inside of the Quick Connect box and insert the plastic ink valve into place. Release the metal tab to lock the bag into place. Insert the black plastic dividers to separate between the four ink bags.

Note— There are 5 (five) bulk ink dampers, but only 4 ink bags. Two dampers are supplied by the Black ink bag. The Black ink bag has a “Y” tube splitter that fills both black ink dampers.



2. Set the bulk ink dampers face down on a flat surface with the round openings facing up. Pierce the thin plastic tab that covers the opening using the tip of a sharp object such as a ball point pen. Firmly insert the tip of the plastic syringe into the gasketed round opening until the tip is completely inserted.

Note – The plunger needs to be pushed in and completely inserted into the syringe.



3. Slowly extract the plunger. Ink will start to flow through the tubing into the damper. Continue extracting the plunger until ink begins to flow into the tip of the syringe. (Note: You may have to repeat this process twice to complete the priming of each ink damper.) Repeat this process for the other three ink bags.

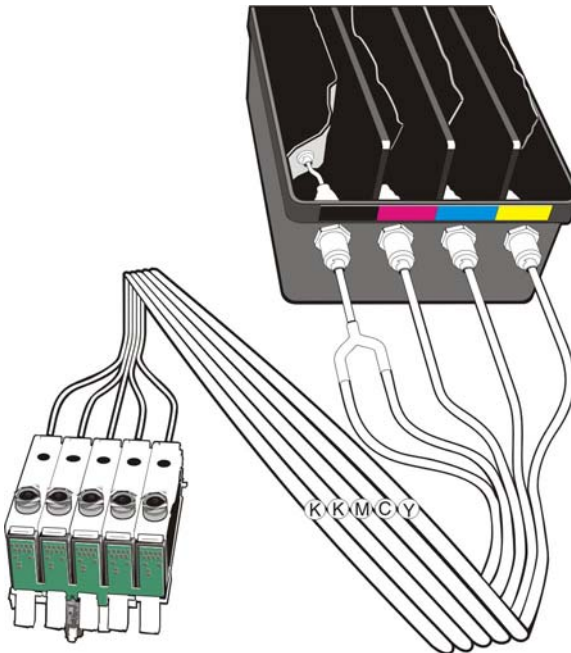

Once the ink bags have been connected your Quick Connect bulk ink system should look like the graphic above.

Printer Set-up for the C120/C110



1. Turn the printer on. Wait for the printer to complete its start-up procedure. Lift the lid, and press the ink button . The ink cartridge bay will shift into a position on the right.



2. Raise the lid of the ink cartridge bay.



3. Firmly grasp the lid and twist it sideways until it becomes dislodged. The lid will not be needed for proper functioning of the printer with either the Quick Connect system or individual ink cartridges.



4. The ink cartridge bay should look like the picture above after removing the ink cartridge cover.



5. Remove the printer cover panel by inserting a flat head screwdriver between the panel and the printer. Gently push the cover panel loose.



6. Insert the flat head screwdriver into the opposite side of the printer. Hold the cover panel with one hand, gently push the cover panel loose and remove it.



7. Place the ink dampers into the empty ink bay cartridge. The Black ink damper should be on the far left side, the yellow on the far right side.



8. Firmly push down the plastic cartridge set of dampers to completely engage the ink dampers into place. Note: You will have to push each individual damper hinge into position until it clicks into place. The printer will not recognize the ink damper until it is firmly pushed into place.



9. Install the plastic support arm. First remove the adhesive backing on the back of the plastic arm.

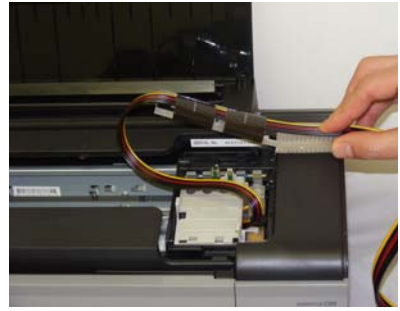

10. The plastic tubing comes pre-attached to the plastic arm with two adhesive bands. Position the plastic arm on the far right side of the printer.

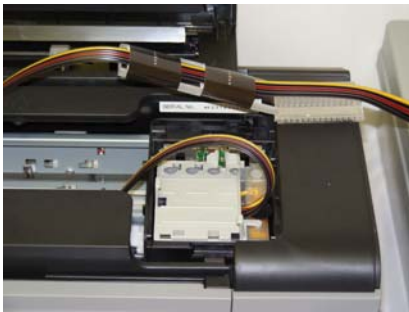

11. The plastic arm should be aligned so that the edge of the adhesive Velcro is situated at the top right hand corner of the ink cartridge bay. Press the plastic arm firmly to set the adhesive Velcro in place.



12. Press printer ink button (second button on the left side of the printer). The printer will start to prime and reset itself. The ink cartridge carriage will move in position.

13. Congratulations. You have installed your C120/C110 Quick Connect bulk ink system. You are now ready to install the ChromaBlast C120/C110 driver software.

Tips:

- Install the Epson C120/C110 OEM driver and perform a nozzle check using the OEM inks before installing the ChromaBlast Driver and the Quick Connect system.
- Perform a nozzle check from The ChromaBlast Driver™. A few cleanings may be necessary to get a good nozzle check.
- Make sure you install ChromaBlast Driver™ from the CD that came with your Quick Connect II system. Refer to the ChromaBlast Driver™ documentation and video tutorial on how to use it.
- You may want to remove the printer lid or leave it open at all times.
- You may have a little air in your lines but this will clear after a few prints.
- If you are going to leave your system without using it for several days you should clamp your lines with the tube clamps.
- Do not raise the ink box higher than the printer



Chip Reset Instructions

The ChromaBlast QuickConnect bulk ink system for the Epson C120/C110 printer contains a cartridge with five individual dampers that is used in place of the individual OEM (Epson) cartridges. This bulk ink system cartridge has a single chip that periodically needs to be reset so that the printer can continue to use ink from the bulk ink system. The frequency of this reset action will depend upon the number of images that are printed and the printer settings.

The following are simple instructions for resetting the bulk ink system.

1. Once the printer recognizes that the ink levels have reached a certain level, it will cease to print and the **orange** ink-out light will start to flash.



2. Press the **ink-out** button until the ink carriage moves into the far right position. The ink carriage will come to rest in the carriage bay area.



3. Press the **white reset button** at the top of the bulk ink system ink cartridge.



4. Again, press the **ink out** button on the front of the printer.



5. The printer will begin to reset and recharge. After the printer has completed the resetting activity, the **orange** light will turn off. At this point the bulk ink system has been successfully reset and the printer is again ready for use.

Installing ChromaBlast™ Cartridges

1. Make sure the printer is on.
2. Open the printer cover.
3. Press and release the ink button . The power and ink lights flash.

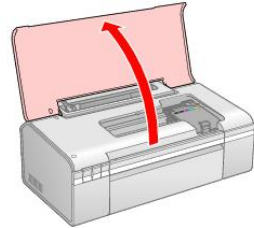

4. Press the Ink Button again  for one second to move the print head into the cartridge replacement position.

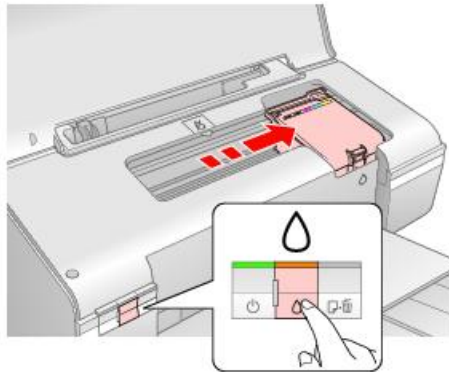

Do not hold the Ink Button for more than 3 seconds or the printer will clean the print head.
Do not move the print head by hand.
Do not open the cartridge cover when the print head is moving.

5. Open the cartridge cover.

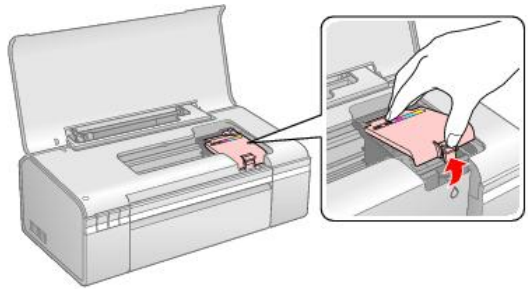

6. Squeeze the tab at the back of the Epson cartridge and lift it straight out. Remove all Epson cartridges from the cartridge holder.

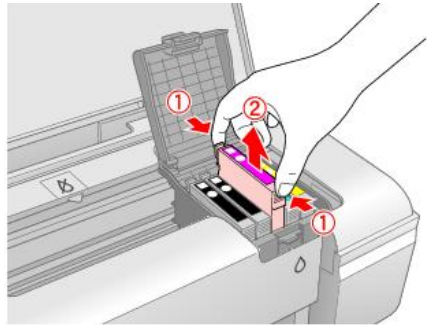

7. Before you open the new ink cartridge package, shake it four or five times. Then remove it from the package.



8. Remove the yellow tape from the bottom of the ink cartridge.



9. Place the new ink cartridge into the cartridge holder and push it down until it clicks into place.

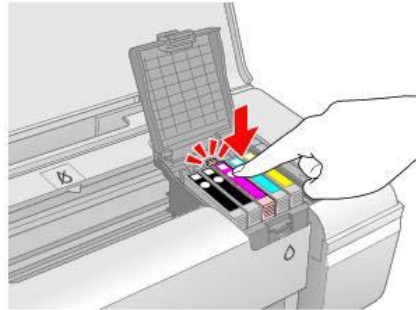

10. Once the ChromaBlast cartridges are in place, close the ink cartridge cover and press it until it clicks into place.

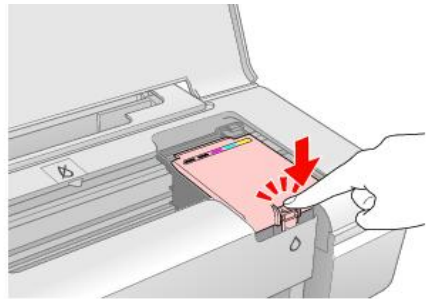

11. Close the printer cover.

12. Press the ink button for one second. The printer begins charging ink and the power light starts flashing. This takes about 1 ½ minutes. When it's finished, the power light stops flashing and remains on, and the ink light goes out.



Never turn off the printer while the power light is flashing or you'll waste ink.

If the ink light stays on (not flashing), the ink cartridge may not be installed correctly. Press the ink button again and reinstall the ink cartridge until it clicks into place.

Replacing an Empty Cartridge

Make sure you have a new ink cartridge before you begin. Once you start replacing a cartridge, you must complete all the steps in one session.

1. Make sure the printer is on.
2. Open the printer cover.

3. Press and release the ink button . The power and ink lights flash. If one of the cartridges is low or expended, the printer moves that cartridge to the expended ink mark. If no cartridges are low or expended, the ink cartridge holder moves to the ink replacement position.

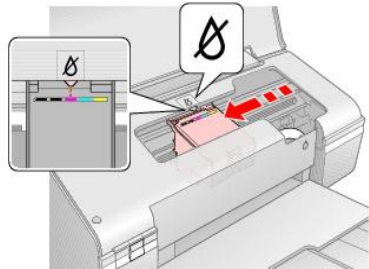

4. Press the ink button  again. If another cartridge is low or expended, it moves to the expended ink mark. Once the printer identifies all of the low or expended ink cartridges, the print head moves to the ink cartridge replacement position.

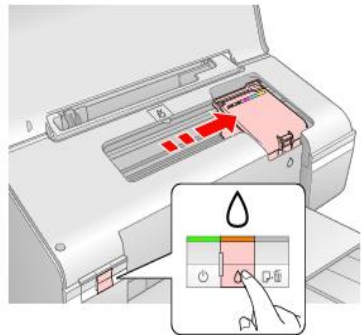

5. Open the cartridge cover.
6. Squeeze the tab at the back of the cartridge and lift it straight out. Dispose of it carefully.

7. Before you open the new ink cartridge package, shake it four or five times. Then remove it from the package.



8. Remove the yellow tape from the bottom of the ink cartridge.



9. Place the new ink cartridge into the cartridge holder and push it down until it clicks into place.

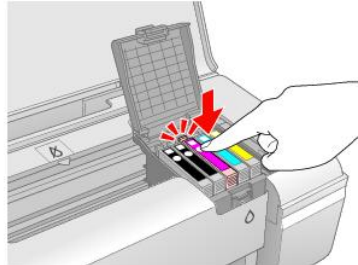

10. Once you replace any other cartridges that need replacing, close the ink cartridge cover and press it until it clicks into place.

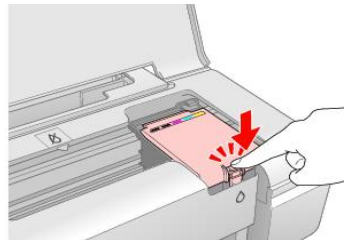

11. Close the printer cover.

12. Press the ink button. The printer begins charging ink and the power light starts flashing. This takes about 1 ½ minutes. When it's finished, the power light stops flashing and remains on, and the ink light goes out.



Never turn off the printer while the power light is flashing or you'll waste ink.

If the ink light stays on (not flashing), the ink cartridge may not be installed correctly. Press the ink button again and reinstall the ink cartridge until it clicks into place.

Printing and Heat Transfer Instructions

RECOMMENDED APPLICATIONS

White or light-colored fabrics in 100% cotton.

PRINTING

Print using the supplied ChromaBlast Driver program only.

The print side of ChromaBlast media is opposite the ChromaBlast logo. For the Epson C120, place print side face up in the printer tray.

Mirror Image: Check this box in the ChromaBlast Driver to ensure the image prints in reverse and that text appears correctly when image is transferred. If your image is already reversed in your graphic program, leave this box unchecked.

TRANSFERRING THE IMAGE USING A COMMERCIAL HEAT PRESS

1. If desired, you may trim the non-printed area before transferring, leaving .25 in. margin around the printed area.
2. Place garment on the heat press. Cover with ChromaBlast paper with image face down.
3. Press image according to proper pressure, heat, and time settings.
4. Peel the paper off the shirt while the shirt is still hot using an even motion.
5. Stretch the image area while the shirt is hot from both left to right and top to bottom to reduce the hand.

HEAT PRESS SETTINGS

Pressure: Heavy. If using a pneumatic press, set the pressure to 60 psi.

Temperature and Time: 350°F (176°C) for 45-60 seconds.

Due to variations in cotton garments and in heat presses, time and temperature can be adjusted for preferred performance up to 400°F for 25 seconds. Some scorching may occur, but will wash out.

STORAGE INSTRUCTIONS

Store ChromaBlast media in a cool, dry area within the provided plastic storage bag. Do not remove from carton until ready to use.

ChromaBlast Driver™ User Guide

For Epson Stylus® C120/C110

For distribution with ChromaBlast™ only
NOT FOR RESALE

Version 1.0

ChromaBlast Driver™ Introduction

Obtaining the benefits of the ChromaBlast Driver™ color management is now incredibly easy - simply print from your application with the ChromaBlast Driver™ rather than the Epson printer driver. The ChromaBlast Driver™ prints your image just like the Epson printer driver except for the colors. Watch how it magically makes ChromaBlast™ ink colors picture perfect!

The ChromaBlast Driver™ delivers both convenience and the highest quality ChromaBlast™ color management technology. The innovation demonstrated by the ChromaBlast Driver™ is the result of our dedication to you, our customers. At Sawgrass Technologies, we are focused on delivering the highest quality digital transfer technology available. We fully expect that you will be “wowed” by the results you obtain with ChromaBlast™ ink and the ChromaBlast Driver™.

The ChromaBlast Driver™ runs under Windows 2000, XP / Vista.

System Requirements

Minimum Hardware:

Pentium 4 – 3.0GHz or Athlon XP 3000+ Processor

1GB System Memory (2 GB System Memory recommended)

Setup Instructions – Windows XP / Vista

Product Overview

The ChromaBlast Driver™ is color management software that has been written as a Windows printer driver. It is designed to work with Epson ink-jet printers and Sawgrass ChromaBlast™ ink. The installation program will install Sawgrass color management software, the Sawgrass ChromaBlast™ printer driver software, and ColorSure tools and utilities.

Quick Start

1. Unpack and setup printer as described in the Epson manual.
2. Install the Epson printer driver and verify printer operation.
3. Insert the ChromaBlast Driver™ CD into the CD-ROM drive on the computer and install the ChromaBlast Driver™.

Step By Step Installation

To get started printing as soon as possible, these are the steps Sawgrass recommends you perform while setting up your sublimation printer driver software.

1. Setup the printer according to the Epson instructions.
2. Install the ChromaBlast inks.
3. Install the Epson printer driver. According to the Epson user's manual.
4. After the Epson driver is installed, check to see which port the printer is set to:
 - a. In XP you can do this by clicking on Start, Printers and Faxes. For XP with the Classic menu enabled, click Start, Settings, Printers.
 - b. Right click on the Epson printer you just installed and click on the Properties option.
 - c. Select the Ports tab and *write down the port the printer is assigned to*. You will use this later in the ChromaBlast Driver™ software installation.
5. Insert the ChromaBlast Driver™ CD into your CD-ROM drive. The installation program should run automatically. (If the program does not automatically run, click Start, Run. Browse to your CD-ROM drive and click on Setup).
6. A reminder message will appear on the computer screen indicating that the Epson C120 or C110 OEM driver will need

to be installed before proceeding with the installation of the PowerDriver software. If you have already installed this OEM driver than click Next to proceed.

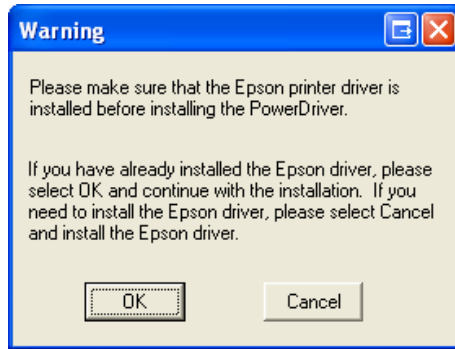

7. The Welcome screen is displayed. Click Next to proceed.

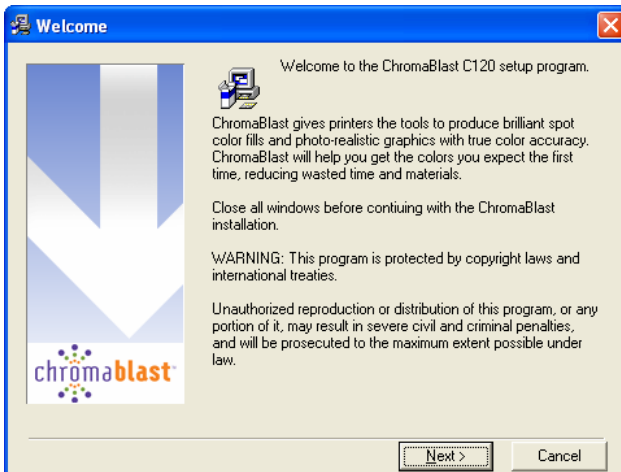

8. The License Agreement is displayed next. Select the appropriate choice for acceptance of the Licensing Agreement to continue.

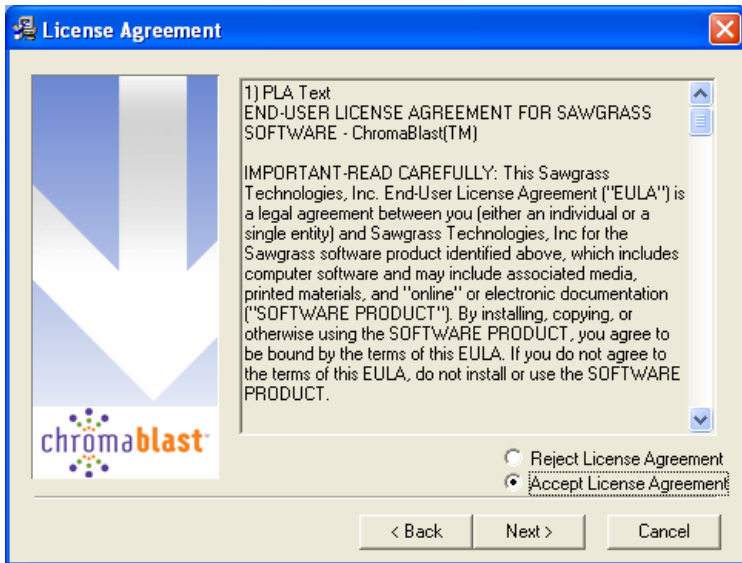

9. If you have not previously registered the ChromaBlast Driver™, you will be prompted to do so. Registering is the only way to take full advantage of the features in the ChromaBlast Driver™. If you choose to register later, select Register Later and click Next to proceed with the installation.

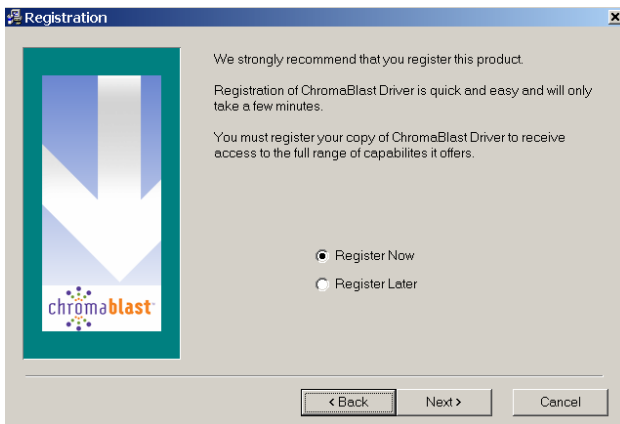

10. If you choose to register now, the registration screen will be displayed. To obtain your registration code you may do so in one of the following ways: Register on-line and receive your registration code via e-mail. Call Sawgrass Technologies, Inc. directly (888) 253-1679 and obtain your code over the phone. Send a fax and receive your registration code by fax.

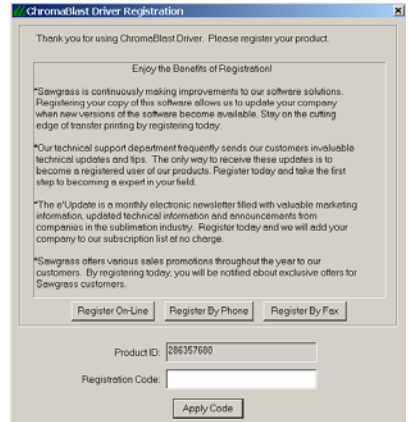

ChromaBlast Driver Registration

Thank you for using ChromaBlast Driver. Please register your product.

Enjoy the Benefits of Registration!

*Sawgrass is continuously making improvements to our software solutions. Registering your copy of this software allows us to update your company when new versions of the software become available. Stay on the cutting edge of transfer printing by registering today.

*Our technical support department frequently sends our customers invaluable technical updates and tips. The only way to receive these updates is to become a registered user of our products. Register today and take the first step to becoming an expert in your field.

*The eUpdate is a monthly electronic newsletter filled with valuable marketing information, updated technical information and announcements from companies in the sublimation industry. Register today and we will add your company to our subscription list at no charge.

*Sawgrass offers various sales promotions throughout the year to our customers. By registering today, you will be notified about exclusive offers for Sawgrass customers.

Register On-Line Register By Phone Register By Fax

Product ID: 086357600

Registration Code:

Apply Code

- To register, you will use your Product ID (displayed on the registration screen) to obtain a Registration code. You will need separate registration code for every machine on which The ChromaBlast Driver™ is installed. Enter your registration code and click the Apply Code button.

11. Sawgrass Technologies, Inc. provides ColorSure color palettes for use with Corel and Adobe. (Check the ColorSure section of the manual for information on how to use ColorSure to get perfect spot colors). If Setup detects either of these applications on your system, the palette files will be placed in the appropriate folder indicated in the Destination Folder box. Click Next to proceed with the installation.

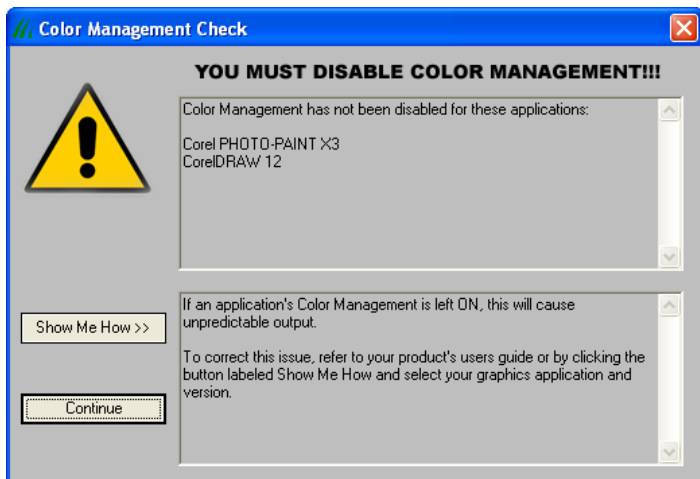
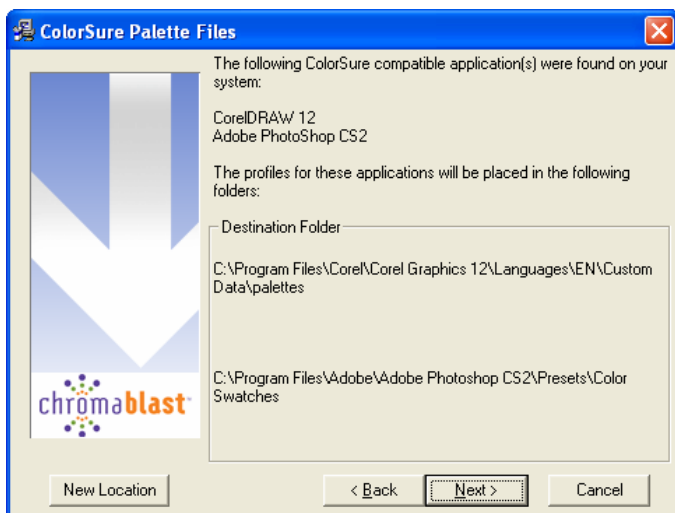

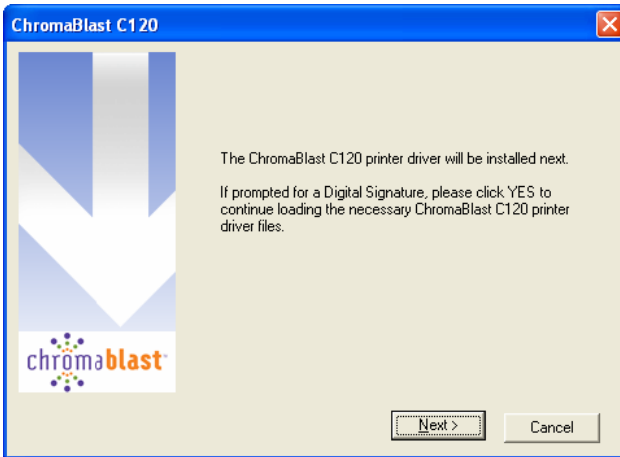

12. Once the installation has completed, the Installation Complete screen will display. Click OK to end the installation.



Using ChromaBlast Driver™ in Windows XP / Vista

The ChromaBlast Driver™ is simple to use. Whenever you have ChromaBlast™ inks in your printer, you should print using the ChromaBlast Driver™. **Do not** print to your Epson printer with the Epson printer driver; printing with the Epson driver will not give you the benefit of color management.

Quick Start Example (Corel Draw)

- 1) Open/Create an image in Corel Draw.
- 2) Select print from the File menu.
- 3) Select the ChromaBlast Driver™ printer.
- 4) Use the properties button to access and set the Color, Output, Ink and Substrate, Resolution, and Advanced options.
- 5) Click Print.

Setting ChromaBlast Driver™ printer properties

To configure the ChromaBlast Driver™ for the correct substrate, you must display its printer properties. There are two ways to display the printer properties:

From the Windows Desktop:

1. Click on Start> Settings> Printers.
2. Right-click on your ChromaBlast Driver™ printer.
3. Select *Properties* from the pop-up menu.
4. Select the *Printing Preferences* button.

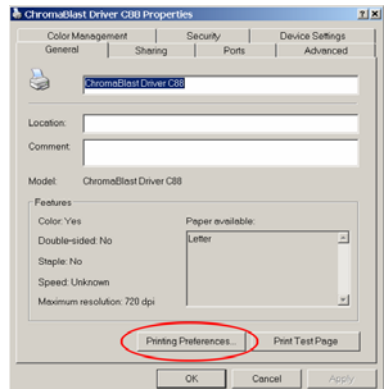

From an Application:

1. Select File, Print Setup.
2. Choose the ChromaBlast Driver™ printer from the list of printers.
3. Click the Properties button.



ChromaBlast Driver™ Properties Overview

The following figure shows the printer properties for a registered version of the ChromaBlast Driver™. The Advanced Color Options tab and the Print Palette functions will not be available if the product has not been registered.

There are three main property groups;

Configuration – Set Paper and Copy Count

Color Settings – Color management control options.

Options – Utilities for printer maintenance, online help, product registration, and setting input profiles

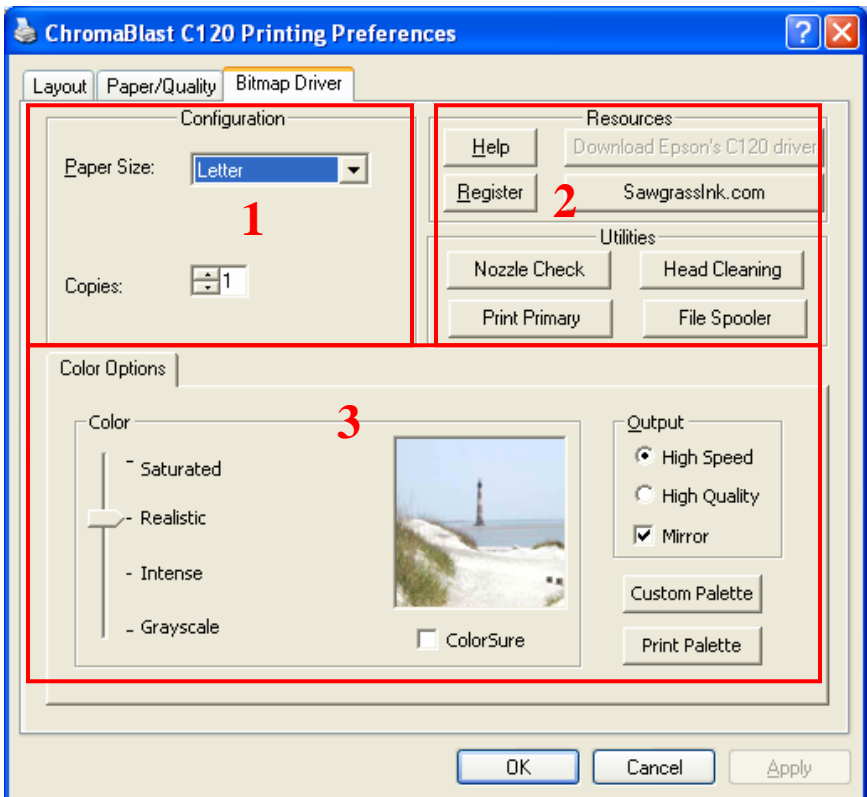

Group 1 – Configuration

Paper Size – From the drop down list, select the paper size you wish to use.

Copies – Sets the copy count for the number of prints to be made.

Group 2 - Color Options

Overview

This group of tabs gives you access to all of the color management controls available in the ChromaBlast C120 or C110 driver. Utilizing the power of the Epson C120/C110 driver technology, the ChromaBlast C120/C110 driver interprets bitmap and vector elements in a similar fashion.

Vector and Bitmap Explanation

Bitmaps are a grid of pixels. Bitmaps come from digital cameras, scanners, and photo CDs. Bitmaps can also be created in applications like Corel PhotoPaint or Adobe PhotoShop. Bitmaps have file extensions like GIF, JPG, BMP, and TIF. Vector components consist of shapes, curves, lines, and text. They are created in programs such as CorelDraw and Adobe Illustrator. Higher end programs like CorelDraw can combine Vector and Bitmaps into a single image. The ChromaBlast C120 driver will color correct all bitmap files and vector components as bitmap images.

Color Correction Settings

Realistic - This setting is most suitable for reproducing skin tones in scanned photographs.

Saturated - The Saturated setting will make the colors in your image more intense. Saturated output tries to remain color accurate with a slight bump in intensity.

Intense – This kicks the color intensity and saturation to the extreme. This setting does not try to keep color accurate; its main goal is to produce deep dark colors. Artwork, graphics, logos, and text are good candidates for this setting. Some photographs will look good

but typically, this setting is too intense to be used with photographs. This can be set for either Bitmap or Vector images.

GrayScale – This setting is most suitable for monochromatic black and white photographic images.

ColorSure Options

The ColorSure enhancement is used to replace specific colors in your image with a spot color chosen from the ColorSure palette. This resulting spot color enhancement is not affected by color setting. A ColorSure spot color will ALWAYS print the same. See Appendix C for an overview of ColorSure.

Print Palette Button – Prints the ColorSure palette for the selected substrate. ColorSure is a method for reproducing exact spot colors. The two main components are; 1) the transferred palette and 2) the CorelDraw, Corel PhotoPaint, and Adobe swatches. For a complete description on how to use ColorSure to get perfect spot colors, see appendix C.

Custom Palette Button – The Custom Palette utility enables you to add, edit, import and export custom colors to the ColorSure palette. If you need to precisely match a specific color, the Color Finder tool makes this a breeze. For a complete description on how to use the Custom Palette, refer to Appendix C.

Output Options

Mirror – When you transfer an image, the result will be “flipped” when compared to the printed image. In order for your transfers to come out correctly, you must flip the image before transferring. Select this option to do the flipping for you. If you are doing this yourself in your editing application, make sure this option is turned off.

High Speed – If the printer supports multiple resolutions, choose the most appropriate setting. For soft substrates, the High Speed option works well.

High Quality – If the printer supports multiple resolutions, choose the most appropriate setting. For hard substrates, choose the High Quality option.

Group 3 – Printer Options

Utilities The utilities options allow you to print a nozzle check pattern, run a print head cleaning cycle, spool a ChromaBlast C120 print file to the printer, and print a page of primary ink colors.

Nozzle Check – Click this button to print a nozzle check pattern. If any of the nozzle check patterns are incomplete, then perform a Print Head cleaning.

Head Cleaning - Performs a Print Head cleaning, after which a Nozzle Check should be performed to verify that the print heads are completely cleaned. Repeat the Head Cleaning until a complete nozzle check pattern is produced.

Print Primary – Use this function to print a page of the primary IQ ink colors (Cyan, Magenta, Yellow, Black)

File Spooler – Use this function to spool multiple print files to the printer.

Resources

Help – This will display a help dialog box for an easy overview of the ChromaBlast C120 driver functions and settings. It also contains a link to the Sawgrass Technologies website.

Register – If the ChromaBlast C120/C110 driver has not been registered, click this button for instructions on how to register the product and unlock all the features.

SawgrassInk.com – This button links you directly to the Sawgrass Technologies website where you can access additional resources such as driver upgrades, documentation and other information regarding sublimation technology.

Appendix A: Network Printing in Windows XP / Vista

Network printing with the ChromaBlast Driver™ in Windows XP and Vista is simple. Before a network printer can be used it must be installed on the network and shared.

Host Machine (Server)

The server machine must have installed the printer and have the printer shared. To install the networked printer, run Start | Setting | Printer | Add Printer. The Wizard will guide you through setting up the printer. When prompted, choose “Network Printer” and browse to the server machine to locate the ChromaBlast Driver™.

Appendix B: Over-Riding Design Software Color Management

The ChromaBlast Driver™ provides a complete color management solution for your ChromaBlast™ media printing. ***It is extremely important that you turn off any color matching features associated with your design software.*** An explanation of how to disable print-time color management in several popular design packages follows:

CorelDraw™ version 10, 11 and 12

1. Create a new graphic.
2. From the main menu choose Tools, Color Management. In the Color Management window (see figure below), set the Style option to Color Management Off.

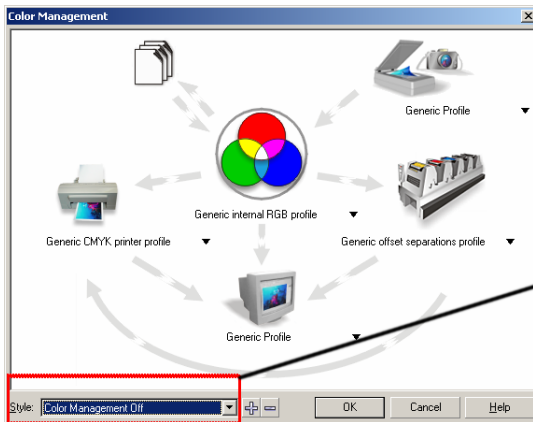

CorelDraw™ version X3:

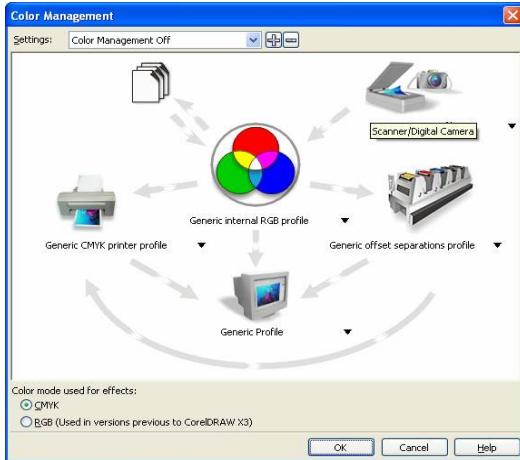

Adobe Photoshop™ 7, CS, and CS2

Color Setup

From the main menu choose Edit, Color Settings. On the Color Settings dialog box, turn all Color Management Policies off. Turn off Profile Mismatches.

Turn off all color management policies and profile mismatches.

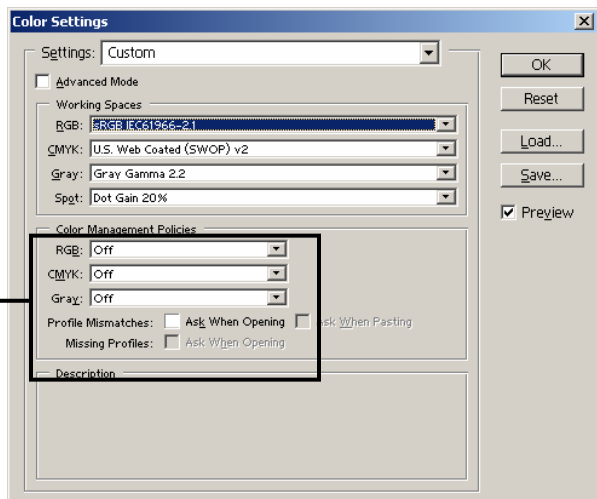

To Print:

Always select File, Print with Preview. On the print dialog page, set the options as described below:

- a. Check Show More Options
- b. Choose Color Management
- c. Choose Document as Source Space
- d. Choose Same as Source for Print Space

From the Color Management drop option list, make sure that Source is set to “Document” and Print Space is set to “Same As Source”.

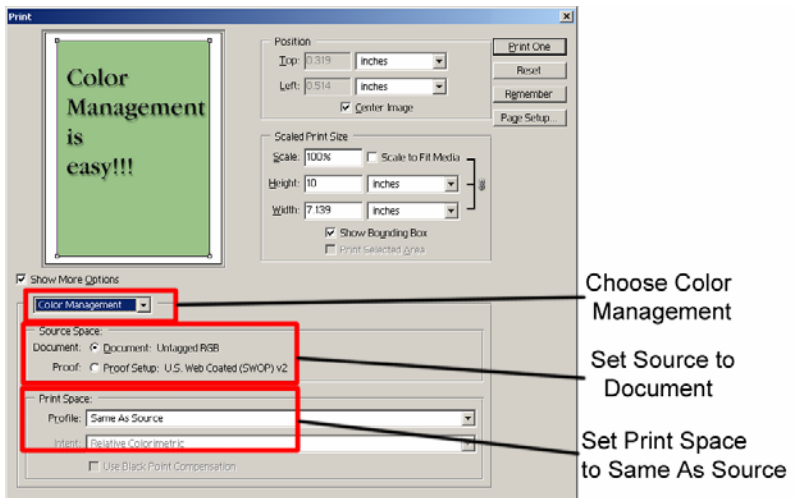

Appendix C: Using ColorSure™ and Custom Palette

I. Introduction

ColorSure is a method for reproducing exact spot colors. There are four main components of the ColorSure System: 1) the printed palette, 2) Color Finder, 3) Custom Palette, and 4) the CorelDRAW and Adobe application palettes / swatches.

1. **ColorSure Palette:** This is your main color palette that includes a wide variety of 152 commonly used colors.
2. **Color Finder:** If a color you need is not on the ColorSure palette, the Color Finder tool allows you to locate the exact custom color you are looking for.
3. **Custom Palette:** With the Custom Palette feature, you can add new custom colors to the existing ColorSure Palette mentioned in step 1.
4. **Application Palettes:** You can add your Color Finder colors to an existing application palette, or you can add multiple custom colors to new, custom palette files (*.cpl, *.acl, etc.).

II. Printing the ColorSure Palette

The first thing you will want to do is to print your ColorSure palette to the shirt you will be using. Most likely you will have customers who desire precise colors. Having your ColorSure palette available allows the customer to choose the color from the palette that is the closest match to what they want, and this gives you a starting point for finding the exact custom color that will match your customer's needs.

To print the ColorSure palette, follow the steps below:

- Click 'Start' and navigate to the 'Printers and Faxes' folder. Right-click on your ChromaBlast Driver™ printer and select 'Printing Preferences' from the menu. You may also open the ChromaBlast Driver™ from within an Adobe or Corel program by going to File, Print, and choosing the ChromaBlast Driver™ printer from the pull-down menu. Click Properties to open the ChromaBlast Driver™.
- Select the color settings and the output (high speed, high quality) that you wish to print the palette, and click the box 'Print Palette'.

- You now have a visual representation of how the ColorSure palette colors will appear on your t-shirt.

III. Designing Your Artwork

By picking colors from the ColorSure palette, you will be able to consistently reproduce colors in a reliable manner. To assist you in designing your artwork, the ChromaBlast Driver™ installs three palettes: two for Adobe products and one for Corel products. These colors match the palette that is printed and within the ChromaBlast Driver™.

- To open the ColorSure Palette in Corel 10, 11, and 12, choose Window | Color Palettes | Open Palette. Select the file “ChromaBlast_Rut.cpl, ChromaBlast_Uni.cpl, or ChromaBlast_Wil.cpl depending on which palette you wish to load.”
- To open the ColorSure Palette in Illustrator, choose Window | Swatch Libraries | Other Library. Navigate to where it was installed to when you installed PowerDriver: C:\Program Files\Sawgrass\PowerDriver\Adobe Illustrator and hit Open. *For easier access to the Palette file copy it from this [above] path to Illustrator10\Presets\Swatches and the palettes will show up in your pull-down list directly under the Swatch Libraries menu. Other versions of Illustrator will have similar steps.*
- To open the ColorSure Palette in Adobe PhotoShop, choose the Swatches Palette, click the option arrow on the palette, choose *Replace Swatches* and pick the “ChromaBlast_Rut.aco, ChromaBlast_Uni.aco, or ChromaBlast_Wil.aco” file.

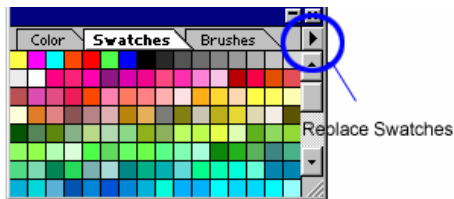

HINT

After you have the ColorSure palette loaded into CorelDraw, move the cursor over each color. As the cursor hovers over each different color, the ColorSure name is displayed in the status area at the bottom of the screen.

IV. Using Color Finder

After printing the ColorSure Palette, you see that you have an array of colors to work with. There will be times, however, when the color you need is not included in the ColorSure Palette. This is a common example of when you will launch the ChromaBlast Driver™ Custom Palette Utility.

The Custom Palette Utility is a small program that coincides with the ChromaBlast Driver™ to assist you in finding custom colors and making custom palettes.

Within the Custom Palette Utility is the Color Finder tool. This tool allows you to start with a specific color (e.g. navy blue) and find similar colors in the same family by adding and subtracting up to three colors (CMYK) called 'Step Colors.' For example, starting with navy blue with a CMYK value of 60,60,0,40 and choosing two step colors (e.g. cyan and magenta) would expand the original navy blue in four directions (more cyan, less cyan, more magenta, and less magenta). This expanded color chart is outputted directly to your printer.

How to use Color Finder:

- First, open the Printing Preferences window.
- At the bottom of the window, click the **Palette Utility** button; this will open the **Custom Palette Utility** window.
- Select the appropriate settings for Printer, Substrate, and Print Quality. Then click the **Start Color Chooser** button and select your desired starting color from the basic colors or the color matrix. To use the color matrix, click anywhere in the matrix window. You can use the slider at the right of the matrix to adjust luminosity. Clicking 'OK' will automatically fill the CMYK boxes with the corresponding values. If you do not wish to use Color Chooser, you also have the option to manually enter the **Start Color** values in the CMYK boxes.
 - For advanced users, CMYK values can be determined by printing out a Custom Palette, which is outlined in the next section.

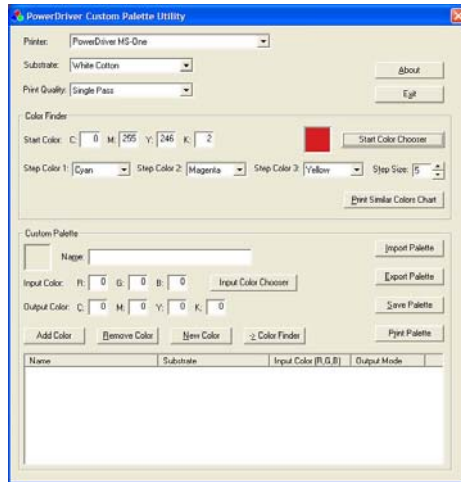

Custom Palette Utility

- You may alter the chosen start color's CMYK value by selecting two or three **Step Colors**. Using multiple step colors will present you with a greater range and variety of colors to choose from.
 - For instance, if you choose to modify your Start Color with two steps, then Step Color 1 will change its values on the X (horizontal) axis and Step Color 2 will change its values on the Y (vertical) axis.

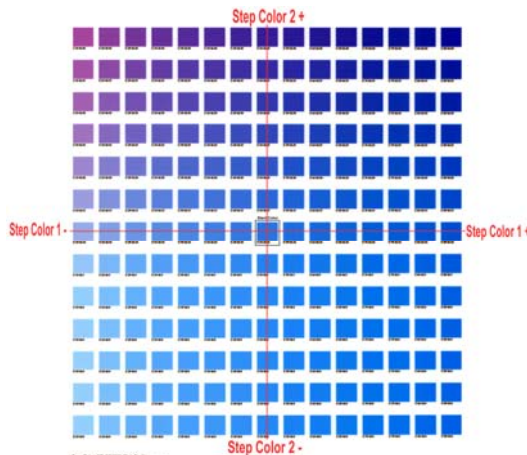

Color Finder Palette with two Step Colors

- If you modify your Start Color with three steps, Step Color 1 will remain the same. However Step Color 2 and Step Color 3 will form an imaginary 'X' and their values will change on opposing diagonal Y axes.

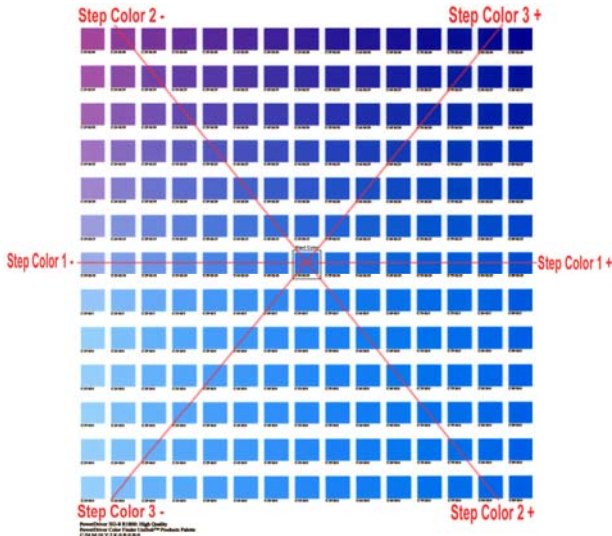

Color Finder Palette with three Step Colors

- Next, determine what **Step Size** you want to apply to the Color Finder palette. This is simply a question of how much you want your Start Color to fluctuate. If your Start Color is close to the color you are looking for, use a low Step Size (i.e. 5-10). However, if your start color is not close to what you are looking for, use a higher Step Size. You can enter any Step Size value between 1 and 40.
 - As an example, let's say your Start Color is C:20, M:100, Y:150, K:0 and you select Cyan and Magenta to be your Step Colors. You also enter a Step Size of 10. When the 'Print Similar Colors Chart' button is clicked, your Start Color will be in the middle of the Similar Colors Chart and from there each color will vary the Cyan and Magenta values by 10.
- When you are finished selecting the Start Color, Step Colors, and the Step Size, click on the **Print Similar Colors Chart**

button. This will print your custom Similar Colors Chart directly to the printer.

- After printing the Color Chart, try to match your desired color to one that is on the palette. If you find a suitable match, you are finished using the Color Finder tool. Move on to **Section V. The Custom Palette**.
- If you couldn't find an accurate match on the first printed Similar Colors Chart, don't worry. Follow the easy steps below, and you will find a more suitable custom color.
 1. First, try to locate a new Start Color from the chart that is closer than the original color.
 2. Next, after finding a more suitable Start Color, write down that color's CMYK value. Here is how to obtain this value. There are numbers under each color that are dependant upon which Step Colors you chose. For example, it might say C:70 M:120. Take note of these values. Then, at the bottom left of the Color Finder palette you will see a full set of CMYK values. The new Start Color's CMYK value would be C:70, M:120 and whatever the YK values are from the full set.
 3. Lastly, plug the CMYK values for the new Start Color into the boxes in Color Finder, choose your Step Size, and click on Print Similar Colors once again. Continue with steps 1-3 until you find your desired color.

V. The Custom Palette

Let us assume that you have found the exact color you need using the Color Finder tool. What you will want to do next is apply these custom color values to either an existing palette, or to create a new custom palette altogether. This allows you access to this color again should the same job arise.

How to use Custom Palette:

- First, you need to assign the CMYK values of the matched color from the Similar Colors Chart to the **Output Color** CMYK fields in the Custom Palette section.
- Give your new custom color a descriptive **Name** in its designated field (e.g. IBM Blue).
- Next, assign an RGB **Input Color** value. There are two methods to establish this value.
 1. If you have the original file, sample the color that was matched in your graphic design application with the eye dropper tool. This will give you the RGB value of that color. Input this value into the RGB Input Color fields of the Custom Palette section.
 2. If you do not have the original file, or the artwork has not yet been designed, simply click on the 'Input Color Chooser' button, and then click on "Define Custom Colors". From the color matrix, find a color that closely resembles the color that you are adding to the custom palette. At the bottom-right of the color matrix window are the RGB values. Simply click 'OK' and the RGB Input Color values will be automatically entered. Please take note of these RGB values for later use in your design applications.
- Click the **Add Color** button. A window will pop up asking you whether you want to add the color to the palette for all substrates, or just the current substrate. Click 'YES' here unless you have the same custom color saved on palettes for other substrates. Another window will then ask you if you want to save the custom color for all resolutions or just the current one. Click 'YES' here unless you have the same custom color saved on palettes for other resolutions.
- Lastly, click the **Save Palette** button. When finished, simply Exit out of the window.

** The 'Import Palette' and 'Export Palette' buttons are convenient to have in the event you need to transfer palettes to and from different computers.*

VI. Adding Swatches to your Application Palette:

It is possible to add your custom color(s) swatch to an application palette as well. You will need to take note of the Input Color RGB value that you assigned in the previous step in order to create the new swatch. Refer to your specific design application software's manual for instructions on this.

Supplies & Equipment

ChromaBlast™ ink and media are sold through a network of Authorized ChromaBlast™ Channel Partners. A full listing of authorized resellers is available on our Web site at www.chromablast.com.

Operating Conditions

Certain environmental conditions should be taken into account for the operation of ChromaBlast™ ink including temperature and relative humidity.

- Operating conditions are 65 ~ 80 °F with 35~60% relative humidity.
- Optimum operating conditions are 70 ~ 75 °F with 40~50% relative humidity.

Ink Storage

- ChromaBlast™ product should be stored in an environmental controlled room with a temperature range of 50 °F ~ 75 °F.
- Do not expose ChromaBlast™ cartridges directly to light, especially sunlight, for extended periods.
- For best results, install your ChromaBlast™ cartridges by the date on the cartridge. Please refer to the individual cartridge for the specific ink expiration date.

Media Storage

- Store the ChromaBlast™ media in a cool, dry area within the provided plastic storage bag. Do not remove from carton until ready to use.

Troubleshooting

The troubleshooting tips found in this section relate mainly to problems that can be seen in transferred ChromaBlast™ images. If you are having problems related to the performance of your printer, please refer to the *Problem Solving* section found in the *EPSON Stylus C120/C110 Printer User's Guide*.

The colors in my transferred image are incorrect

- The image may need color adjustment. Use the ChromaBlast Driver™ color matching software. For more information on how to use this software, please see the section entitled *ChromaBlast Driver™ User's Guide*.
- Ensure you used the right printer driver and driver settings. Please see the section entitled *ChromaBlast Driver™ User's Guide*.
- Ensure you pressed the item with the proper time, temperature, and pressure. For guidelines see the section entitled *Printing and Heat Transfer Instructions*.
- Verify all colors print correctly. Run the Nozzle Check utility and clean the print heads as required.

My printout gets cut off on the bottom or side

- Verify the printer driver is setup for the correct paper size. Your printer driver setting needs to match the media size that is loaded in your printer.
- Ensure the right paper guide is in the proper position on the printer. When setting up the printer, slide the right paper guide to the left until it clicks into position.

My image looks good but it washes out

- Ensure you pressed the garment with the proper time, temperature, and pressure. For guidelines, see the section entitled *Printing and Heat Transfer Instructions*.
- Ensure you used the recommended ChromaBlast™ media and inks.

Colors are light and splotchy

- Ensure you printed on the correct side of the media. For the Epson C120/C110 place print side face up in the printer tray so that the missing corner is in the top right hand side when facing the printer.
- Ensure you used the recommended ChromaBlast™ media and inks.
- Ensure you pressed the item with the proper time, temperature, and pressure. For guidelines, see the section entitled *Printing and Heat Transfer Instructions*.
- Verify your printer driver settings are correct. Please see the section entitled *ChromaBlast Driver™ User's Guide* for additional information.

My image looks blurred

- Ensure you pressed the item with the proper time, temperature, and pressure. For guidelines, see the section entitled *Printing and Heat Transfer Instructions*.
- Ensure you used the recommended ChromaBlast™ media and inks.
- Ensure you printed on the correct side of the media. For the Epson C120/C110 place print side face up in the printer tray so that the missing corner is in the top right hand side when facing the printer.
- Verify that the printer's print heads are properly aligned. For further instructions, see the *EPSON Stylus C120/C110 Printer User's Guide*.

My image has gaps or bands present

- Ensure that all of the printer's nozzles are firing properly. Perform

a Nozzle Check from the *Utility* tab of your printer driver. For further instructions, see the *EPSON Stylus C120/C110 Printer User's Guide*

- If one or more of the nozzles fail to print, perform a Print Head Cleaning. For further instructions, see the *EPSON Stylus C120/C110 Printer User's Guide*.

Technical Support

If you are having difficulties achieving good results from your ChromaBlast™ inks or media, you have several support options:

1. **Telephone:** You may contact your authorized SubliJet reseller during their normal hours of operation for assistance. A full listing of authorized SubliJet Resellers is available on our Web site at www.sawgrassink.com. In addition, you may also contact Sawgrass Technical Support at (888) 253-1679 between the hours of 8:30 AM and 5:30 PM Eastern Standard Time.
2. **Internet:** Visit the *Technical Support* area of the Sawgrass Technologies, Inc. website at www.sawgrassink.com. The troubleshooting utility found here will provide you with solutions to some of the most common problems. You may submit a detailed description of your problem if you need further assistance.
3. **E-mail:** You may e-mail Sawgrass Technical Support with a detailed description of your problem at support@sawgrassink.com.
4. **Fax:** You may fax a detailed description of your problem to Sawgrass Technical Support at (843) 849-3847.

Project Cotton

Project Cotton is a series of workshops and courses designed to provide the knowledge, skills and strategies for growing a profitable digital cotton decorating business.

Project Cotton will provide current and prospective garment decorators with knowledge, skills, strategies and ideas to build and grow their cotton printing business.

Whether you are a new system purchaser, or a current user wanting to learn more, Project Cotton can help you grow and expand your business. Project Cotton will provide insight into profitable new markets and new products. Project Cotton will share innovative sales strategies to assist you in increasing sales and growing your business. On the operations side, Project Cotton provides tools to increase the productivity and profitability of your business.

Project Cotton events are offered throughout the country through Authorized Sawgrass Channel Partners

Please visit our website to request more information on an event in your area. Call toll-free 1.888.780.7349 or email project.cotton@sawgrassink.com.

We look forward to seeing you at a Project Cotton event in the very near future!