

Creda

*INSTRUCTIONS for INSTALLATION
and USE*

*Gas Hob
W810*

This appliance must be installed in accordance with regulations in force and only in a well ventilated place.

Ensure that the hob unit is securely fixed to the worktop before use.

To the Installer

Before installation fill in the product details on the back cover of this booklet. The information can be found on the rating plate.

To the User

You must read the instructions prior to using the appliance and then retain them for future reference.

CONTENTS

Introduction	3
For Your Safety – Always	4
For Your Safety – Never	5
Using The Hob	6
Care & Cleaning	7
Something Wrong?	8
Installation	9 - 14
Key contacts	Back Cover

Retention of this Instruction Book

This Instruction Book must be kept handy for reference as it contains important details on the safe and proper use of the appliance.

If you sell or pass the appliance to someone else, or move house and leave it behind, make sure this Book is also provided so the new owner can become familiar with the appliance and safety warnings.

If the Book is lost or damaged a copy may be obtained from GDA Ltd, Morley Way, Peterborough, PE2 9JB.

INTRODUCTION

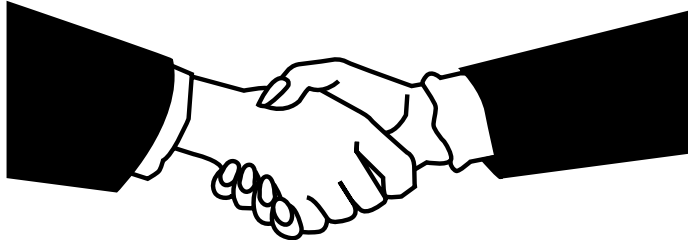

Your new hob is guaranteed* and will give lasting service. This guarantee is only applicable if the appliance has been installed in accordance with the installation instructions detailed in this booklet.

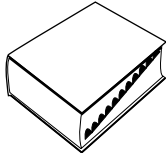

To help make best use of your cooking equipment, please read this booklet carefully.

The hob is designed specifically for domestic use and responsibility will not be accepted for use in any other installation.

*** The guarantee is subject to the provisions that the appliance:**

- (a) Has been used solely in accordance with the Users Instruction Book.**
- (b) Has been properly connected to a suitable supply voltage and gas supply as stated on the rating plate attached to this equipment.**
- (c) Has not been subjected to misuse or accident or been modified or repaired by any person other than the authorised employee or agent.**
- (d) Has been correctly installed.**

FOR YOUR SAFETY



When used properly, your appliance is completely safe but as with any product there are certain precautions that must be observed.

PLEASE READ THE PRECAUTIONS BELOW BEFORE USING YOUR APPLIANCE.

ALWAYS

- Always make sure you understand the controls prior to using the appliance.
- Always keep children away from the appliance when in use as the surfaces will get extremely hot during and after cooking.
- Always make sure all controls are turned off when you have finished cooking and when not in use.
- Always take care to avoid heat/steam burns when operating the controls.
- Always turn off the electricity supply at the wall switch and allow the appliance to cool before cleaning .
- Always keep the appliance clean as a build up of grease or fat from cooking can cause a fire.
- Always follow the basic principles of food handling and hygiene to prevent the possibility of bacterial growth.
- Always refer servicing to a qualified appliance service engineer.
- Always dry food thoroughly before frying, and lower it slowly into the hot oil or fat. Frozen foods, in particular, will cause frothing and spitting, if added too quickly.
- Always keep the outside of the pan clean and free from streaks of oil or fat.
- Always place pans centrally over the burner making sure handles are kept away from the edge of the hob and cannot become heated by other burners / pans.

SAFETY ADVICE

IMPORTANT - As with any cooking appliance there could be some fire risk attached to the heating of oil, particularly for deep fat frying. Cooking utensils containing oil **must not be left unattended** (e.g. to answer the telephone) on or in close proximity to the cooking areas.

IN THE EVENT OF A CHIP PAN OR ANY OTHER PAN FIRE:

1. TURN OFF THE BURNERS.
2. COVER THE PAN WITH A FIRE BLANKET OR DAMP CLOTH, this will smother the flames and extinguish the fire.
3. LEAVE THE PAN TO COOL FOR AT LEAST 60 MINUTES BEFORE MOVING IT. Injuries are often caused by picking up a hot pan and rushing outside with it.

NEVER USE A FIRE EXTINGUISHER TO PUT OUT A PAN FIRE as the force of the extinguisher is likely to tip the pan over. Never use water to extinguish oil or fat fires.

FOR YOUR SAFETY

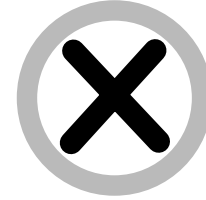

NEVER

- Never leave children unsupervised where a cooking appliance is installed as all cooking surfaces will be hot during and after use.
- Never allow anyone to sit or stand on any part of the appliance.
- Never store items above the appliance that children may attempt to reach.
- Never leave anything on the hob surface when unattended and not in use.
- Never heat up unopened food containers as pressure can build up causing the container to burst.
- Never store chemicals, food stuffs or pressurised containers in or on the appliance, or in cabinets immediately above or next to the appliance.
- Never place aluminium or plastic foil or plastic containers directly on the hob surface.
- Never fill a deep fat frying pan more than 1/3 full of oil, or use a lid. **DO NOT LEAVE UNATTENDED WHILE COOKING.**
- Never use the appliance as a room heater.
- Never dry any items on the hob.
- Never use misshapen pans which may be unstable.
- Never use round base woks directly on the pan supports.
- Never use fish kettles or large preserving pans across two burners.

NOTE: The use of a gas cooking appliance results in the production of heat and moisture in the room in which it is installed. Always ensure that the kitchen is well ventilated; keep natural ventilation holes open or install a mechanical ventilation device (mechanical extractor hood).

In particular, when using the grill or more than one hotplate burner, open a window if a mechanical ventilation device is not operating.

USING THE GAS HOB - FEATURES

In order to obtain maximum performance from the burners, use pans with the following diameters:

Rapid burner 22 - 28 cm
Standard burner 14 - 22 cm
Auxillary burner 10 - 14 cm

All pans should be positioned centrally over the burners.

DO NOT allow young children near to the appliance when the hob is in use as the surfaces get extremely hot.

OPERATION WHEN USING THE GAS HOB

- Step 1** Check that the electricity is switched ON.
- Step 2** Press the ignition button and then push and turn the control knob of the chosen burner anticlockwise to the large flame symbol. The gas should then ignite.
- Step 3** Turn the control knob anticlockwise to the desired setting. Only turn the control knob between the large flame symbol and the small flame symbol when adjusting the setting.
- Step 4** Place the pan centrally on the required burner.
- Step 5** To switch off, turn the control knob fully clockwise.

CARE AND CLEANING



SWITCH OFF THE ELECTRICITY SUPPLY BEFORE CLEANING. BEFORE SWITCHING ON AGAIN, ENSURE THAT ALL CONTROLS ARE IN THE OFF POSITION.

NEVER USE BIOLOGICAL WASHING POWDER, HARSH ABRASIVES, SCOURING PADS, AEROSOL CLEANERS OR OVEN CHEMICAL CLEANERS OF ANY KIND.

Clean the hob regularly and wipe up spills soon after they occur to prevent them from becoming burnt on.

CLEANING MATERIALS TO AVOID

1. Household abrasive powders, e.g. Vim.
2. Oven chemical cleaners, aerosols and oven pads.
Caustic cleaners such as these will etch the surface and attack the metal frame.
3. Bath and sink cleaners may mark the surface.

VITREOUS ENAMEL HOB, PAN SUPPORTS AND BURNER CAPS.

Wipe with a cloth wrung out in hot soapy water. Stubborn stains can be removed with a cream paste or liquid cleaner.

STAINLESS STEEL.

Wipe with a cloth wrung out in hot soapy water followed by a wipe with a cloth wrung out in clear water and then dried with a soft clean cloth.

ALUMINIUM BURNER BODIES AND RINGS.

Wipe with a cloth wrung out in hot soapy water only; do not use abrasives. Use a nylon brush to remove any cleaning materials, water or dirt from the burner bodies. Re-assemble as in the diagram below.

CONTROL KNOBS.

Wipe over the knobs with a soft cloth wrung out in hot soapy water or mild non-abrasive cleaner. Then, after wiping with a cloth wrung out in clear water, dry with a soft clean cloth.

Never use scouring pads or abrasive cleaners/powders which may scratch the surface.

BURNER ASSEMBLY

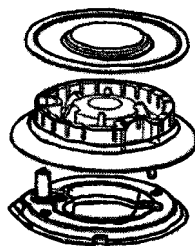

SOMETHING WRONG ?

IF THE IGNITION DOES NOT WORK

Is the electricity switched on?

If the electricity supply has failed, the burners can be lit with a match.

If only a hotplate burner is failing to ignite, check that the burner body and cap are seated correctly and that the slots in the burner body are not blocked (see care and cleaning).

May we wish you many years of carefree successful cooking.

Disposal of your product

To minimise the risk of injury to children please dispose of your product carefully and safely. Remove all doors and lids (where fitted). Remove the mains cable (where fitted) by cutting off flush with the appliance and always ensure that no plug is left in a condition where it could be connected to the electricity supply.

To help the environment, Local Authority instructions should be followed for the disposal of your product.

This appliance conforms to the following EEC Directives:



Low Voltage Equipment
73/23/EEC
93/68/EEC

Gas Appliances
90/396/EEC
93/68/EEC

Electromagnetic Compatibility
89/336/EEC
92/31/EEC
93/68/EEC

INSTALLATION - electrical requirements

**WARNING – THIS APPLIANCE MUST BE EARTHED.
CONNECT TO A 230-240V A.C. SUPPLY ONLY.**

Connection to the electricity supply should be made via a properly earthed, readily accessible wall socket which is adjacent to but not directly above, and not more than 1.25m away from the appliance and capable of electrical isolation.

Should this plug not fit the socket outlet in your home it should be cut off and replaced with a suitable plug as outlined below.

NOTE: The removed plug cannot be used for any other appliance and should therefore be properly disposed of and not left where children might find it and plug it into a supply socket – with the obvious consequent danger.

IF THE FITTED PLUG IS REMOVED

The flexible mains lead must be correctly connected as below to a three pin plug of not less than 13 amp capacity. If a B.S. 1363 fused plug is used, it must be fitted with a 3 amp fuse which is approved to B.S. 1362.

IMPORTANT: The wires in the mains lead fitted to this appliance are coloured in accordance with the following code:

GREEN AND YELLOW	– EARTH
BLUE	– NEUTRAL
BROWN	– LIVE

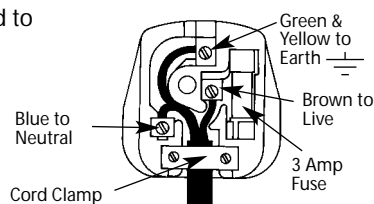

As the colours of the wires in the mains lead of this appliance may not correspond with the coloured markings identifying the terminals in your plug, proceed as follows:– The wire which is coloured green and yellow must be connected to the terminal in the plug which is marked with the letter E or by the earth symbol \equiv or coloured green or green and yellow. The wire which is coloured blue must be connected to the terminal which is marked with the N or coloured black. The wire which is coloured brown must be connected to the terminal which is marked with the letter L or coloured red. When wiring the plug, ensure that all strands of wire are securely retained in each terminal. Do not forget to tighten the mains lead clamp on the plug. As the appliance must be earthed, **do not use 2-pin sockets outlets, if you are in doubt, consult a qualified electrician.**

Should the mains lead ever require replacement, it is essential that this operation be carried out by a qualified electrician and should only be replaced with a flexible cord of the same size i.e. 0.75mm² cross sectional area and temperature rating of 85°C e.g. heat resisting PVC.

IF A MOULDED PLUG IS FITTED

In the event of replacing a fuse in the plug supplied a 3 amp ASTA approved fuse to BS1362 must be fitted.

NOTE: The fuse cover must be refitted when changing the fuse. In the event of losing the fuse cover the plug must not be used until a replacement fuse cover has been obtained and fitted. A new fuse cover can be obtained from your local Electricity Board. The colour of the correct replacement fuse cover is that of the coloured marks or inserts in the base of the plug.

Make sure that the cable does not become trapped.

INSTALLATION INSTRUCTIONS

Gas Category II_{2H3+} (GB,IE)

Model Numbers W810, BG05

These models are set to burn NATURAL GAS (G20) at 20mbar.

They can also be converted to burn BUTANE GAS (G30) at 28mbar or PROPANE GAS (G31) at 37mbar using the conversion kit included.

Technical Data

Gas Connection Rp 1/4 (1/4" BSP female)

Pressure test point Burner injector

Gas rate adjustment None

Aeration adjustment None

Electrical Connection 230-240V ac. 50Hz Heat resistant PVC 85°C 0.75mm² Flexible cord.

	Natural Gas		LPG	
BURNER	HEAT INPUT	INJECTOR	HEAT INPUT	INJECTOR
Front Left	3.0 kW	130	3.0 kW	92
Rear Right and Rear Left	2.0 kW	105	2.0 kW	72
Front Right	1.15kW	80	1.15kW	55

INSTALLATION INSTRUCTIONS

Prior to installation, ensure that the local distributions (nature of the gas and gas pressure) and the adjustment conditions are compatible. The adjustment conditions for this appliance are stated on the rating plate which is fitted on the underside of the base panel. This appliance is not designed to be connected to a combustion products evacuation device. It must be installed and connected in accordance with current installation regulations. Particular attention should be given to the relevant requirements regarding ventilation.

GAS SAFETY (INSTALLATION & USE) REGULATIONS

It is the law that all gas appliances are installed by competent persons in accordance with the current edition of the above regulations. It is in your interest and that of safety to ensure compliance with the law.

In the UK, CORGI registered installers work to safe standards of practice.

The cooker must also be installed in accordance with BS 6172:

Failure to install the cooker correctly could invalidate the warranty liability claims and could lead to prosecution.

LOCATION

The cooker may be located in a kitchen, kitchen/diner or a bed-sitting room, but not in a room containing a bath or shower. The cooker must not be installed in a bed-sitting room of less than 20m³.

PROVISION FOR VENTILATION

The room containing the cooker should have an air supply in accordance with BS 5440: Part 2.

The room must have an opening window or equivalent; some rooms may also require a permanent vent. If the room has a volume between 5 and 10m³, it will require an air vent of 50cm² effective area unless it has a door which opens directly to outside. If the room has a volume of less than 5m³, it will require an air vent of 100cm² effective area. If there are other fuel burning appliances in the same room, BS 5440: Part 2 should be consulted to determine air vent requirements.

INSTALLATION

SITING THE HOB

The hob is designed to fit into worktop and base unit(s) with a cutout as shown in Fig.1. Any obstruction such as supports or side panels must be removed to allow 30mm minimum depth below the worktop cutout. Any overhead surface of combustible material must not be closer than 600mm. When installing next to a tall cupboard, partition or wall, for a minimum distance of 400mm above the hotplate a side clearance of at least 40mm should be allowed from the edge of the cutout. This is a type X appliance regarding installation requirements, it is recommended that a shelf is fitted to the cabinet under the hob, but no closer than 10mm to prevent access to the underside of the hob which will become hot when in use.

If a cooker hood is to be installed refer to the manufacturer's instructions regarding fixing heights.

FITTING THE HOB

Unpack the hob from the carton.

Remove the bag containing the sealing tape, fixing brackets, screws and gas inlet elbow.

Fit the sealing tape around the edge of the cut-out in the worktop.

Connect the gas inlet elbow supplied to the end of the hob gas pipe. During installation, it is important not to twist the hob gas pipe when connecting to or adjusting the position of the gas inlet elbow to avoid the possibility of disturbing gas tight joints inside the hob. Ensure that the inlet is held securely:

- * When loosening or tightening the hob gas pipe securing nut.
- * When connecting fittings to it.

Also, ensure that connecting pipe work does not twist the inlet elbow away from its free position.

Lower the hob into the worktop ensuring the mains lead is fed into the base unit and is not trapped under the flanges.

Fix the hob to the worktop using the fixing brackets and screws.

NB Do not over tighten the hob clamps as distortion of the hob may occur.

Connect the hob to the gas supply and check for gas soundness. If a flexible hose is used for connection, it should be fitted such that it cannot come into contact with moveable parts of the housing (e.g. a drawer), does not pass through a space where it is likely to become trapped or damaged and hangs freely downwards. The temperature rise of the area of the base panel likely to come into contact with a flexible hose does not exceed 70°C

Connection must be by rigid pipework when the hob is installed above an oven.

Put the burner rings and caps into position.

Connect the hob to the electrical supply (see INSTALLATION - Electrical Requirements).

Ensure that the hob is functioning correctly prior to use. Instruct the user in the operation of the hob.

INSTALLATION

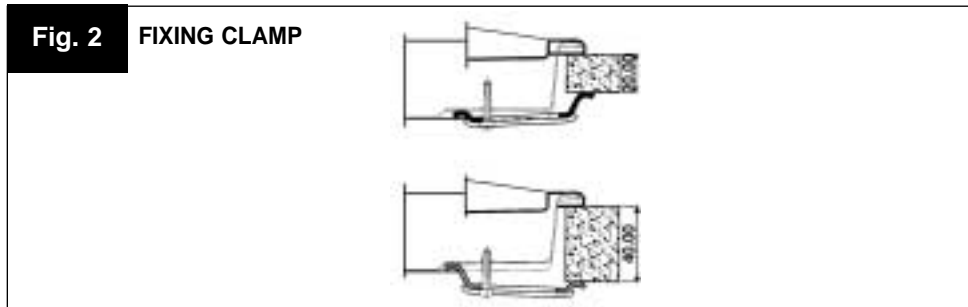
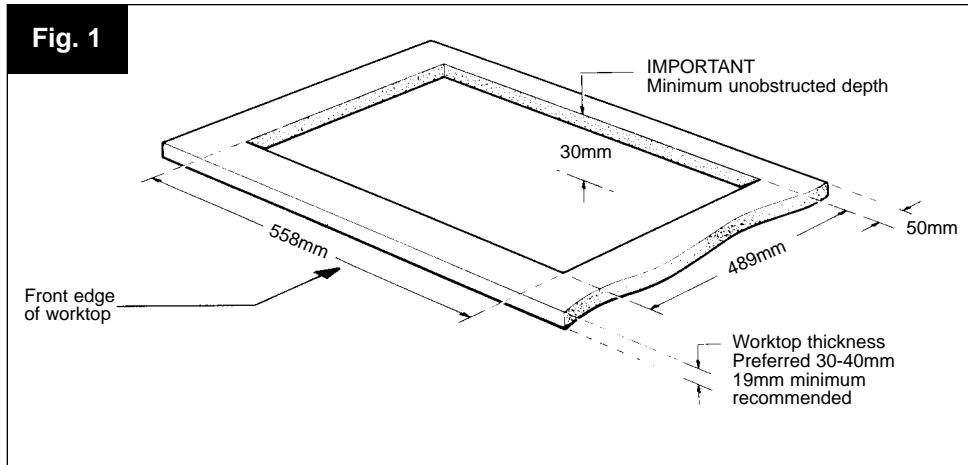

Note: Do not over tighten the hob clamps as distortion of the hob may occur.

INSTALLATION INSTRUCTIONS

LPG Conversion Instructions for Model W810, BG05

Read the Gas Hob instructions before conversion, installation and using the Gas Hob.

Contents of kit:

- 1 Rapid burner injector marked 92 - 1 off
- 2 Semi-rapid burner injector marked 72 - 2 off
- 3 Auxillary burner injector marked 55 - 1 off

Hotplate Burner Injector Change and Bypass Screw Adjustment

Ensure that the Gas Hob is disconnected from the gas and electricity supply (Fig.1)

1. Remove pan supports, burner caps, burner bodies and control knobs (Fig.2)
2. Remove each injector and replace with LPG injector using 7mm A/F hexagonal socket (Fig.3).
3. Turn each gas tap bypass screw fully clockwise using a small flat bladed screwdriver through the holes in the control panel.
The bypass screw is located to the side of the tap spindle (Fig.4).

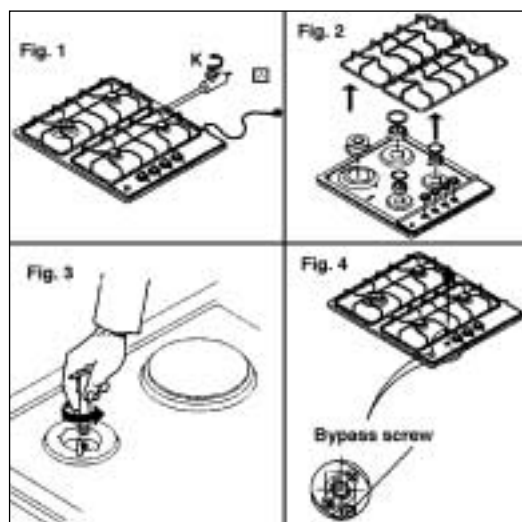

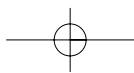
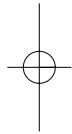
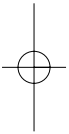

Key Contacts

Service

Creda has the largest appliance manufacturer's service team in Europe, trained specialists directly employed by us to ensure your complete confidence.

Repair Service

UK: 08709 066 066

Republic of Ireland: 1850 302 200

You will be asked for the following information:-

Name, address and postcode.

Telephone number

Model / Serial number of the appliance

Clear and concise details of the query or fault

Place and Date of purchase

(Please keep the receipt as evidence will be required when the engineer calls).

Extended Warranty

To join: UK 08709 088 088

Republic of Ireland: 1850 502 200

Genuine Parts & Accessories

Mail Order Hotline

UK: 08709 077 077

Republic of Ireland: (01) 842 6836

For further product information 08701 546575

All Creda Services are offered as an extra benefit and do not affect your statutory rights.

The logo for Creda, featuring the word "Creda" in a bold, white, sans-serif font centered within a solid black rectangular box.

General Domestic Appliances Limited, Morley Way, Peterborough, PE2 9JB