

DVD Kitchen Radio with dock for iPod



Thank you for choosing Philips.

Need help fast?

Read your Quick Start Guide and/or User Manual first for quick tips that make using your Philips product more enjoyable.

If you have read your instructions and still need assistance, you may access our online help at

www.philips.com/usasupport



Philips vous remercie de votre confiance.

Besoin d'une aide rapide?

Les Guide d'utilisation rapide et Manuel de l'utilisateur regorgent d'astuces destinées à simplifier l'utilisation de votre produit Philips.

Toutefois, si vous ne parvenez pas à résoudre votre problème, vous pouvez accéder à notre aide en ligne à l'adresse

www.philips.com/usasupport



Gracias por escoger Philips

Necesita ayuda inmediata?

Lea primero la Guía de uso rápido o el Manual del usuario, en donde encontrará consejos que le ayudarán a disfrutar plenamente de su producto Philips.

Si después de leerlo aún necesita ayuda, consulte nuestro servicio de asistencia en línea en

www.philips.com/usasupport



PHILIPS

Note : This equipment has been tested and found to comply with the limits for a Class B digital device, pursuant to part 15 of the FCC Rules. These limits are designed to provide reasonable protection against harmful interference in a residential installation. This equipment generates, uses, and can radiate radio frequency energy and, if not installed and used in accordance with the instruction manual, may cause harmful interference to radio communications. However, there is no guarantee that interference will not occur in a particular installation. If this equipment does cause harmful interference to radio or television reception, which can be determined by turning the equipment off and on, the user is encouraged to try to correct the interference by one or more of the following measures :

- Relocate the receiving antenna.
- Increase the separation between the equipment and receiver
- Connect the equipment into an outlet on a circuit different from that to which the receiver is connected.
- Consult the dealer or an experienced radio/TV technician for help.

IMPORTANT !

modifications not authorized by the manufacturer may void users authority to operate this device.

Remarque : Cet équipement a été testé et a été certifié conforme aux limites imposées pour un appareil numérique de Classe B, conformément à la partie 15 des règlements FCC. Ces limites sont définies aux fins d'assurer une protection raisonnable contre les interférences nuisibles dans une installation résidentielle. Cet équipement génère, utilise et émet des fréquences radio qui, en cas d'une mauvaise installation ou d'une utilisation non-conforme aux instructions de ce manuel d'utilisation peuvent causer des interférences nuisibles aux communications radio. Il n'y a toutefois aucune garantie que des interférences nuisibles ne se produiront pas dans une installation donnée. Si cet équipement cause des interférences nuisibles avec votre poste radio ou de télévision, ce que vous pouvez déterminer en éteignant et en rallumant votre équipement, il est conseillé à l'utilisateur d'essayer de pallier à ces interférences nuisibles en prenant l'une ou l'autre des mesures suivantes:

- Changez la position de l'antenne de réception.
- Augmentez la séparation entre l'équipement et le récepteur.
- Branchez l'équipement sur une source d'alimentation différente de celle sur laquelle le récepteur est branché.
- Consultez votre distributeur ou un technicien qualifié en la matière pour assistance.

IMPORTANTE !

las modificaciones no autorizadas por el fabricante pueden anular la autoridad de los usuarios para utilizar este aparato.

Nota : Este aparato ha sido probado y cumple con los límites correspondientes a un aparato digital de Clase B, según la parte 15 de las Normas FCC. Estos límites han sido diseñados para facilitar suficiente protección frente a interferencias perjudiciales en una instalación residencial. Este aparato genera, utiliza y puede emitir energía de frecuencias de radio y, si no se instala y utiliza según el manual de instrucciones, puede provocar interferencias perjudiciales en las comunicaciones de radio. Sin embargo, no existe garantía de que las interferencias no ocurrirán en una instalación particular. Si este aparato provoca interferencias perjudiciales en la recepción de radio o televisión, que se puede identificar encendiendo y apagando el aparato, recomendamos al usuario que intente solucionar las interferencias siguiendo una o más de las siguientes medidas:

- Cambie la posición de la antena receptora.
- Aumente la separación entre el aparato y el receptor.
- Conecte el aparato a una toma de un circuito diferente al que está conectado el receptor.
- Consulte con el distribuidor o un técnico de radio/TV con experiencia para que le ayuden.

¡IMPORTANTE!

modificações não autorizadas pelo fabricante, podem causar danos na operação deste aparelho.

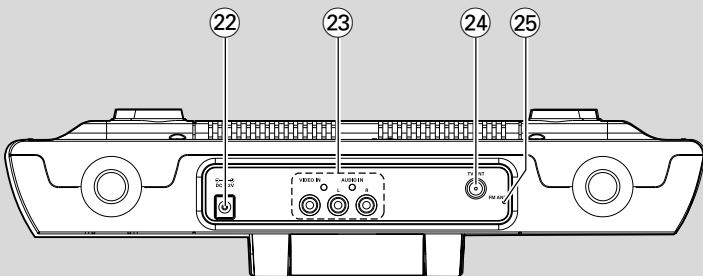
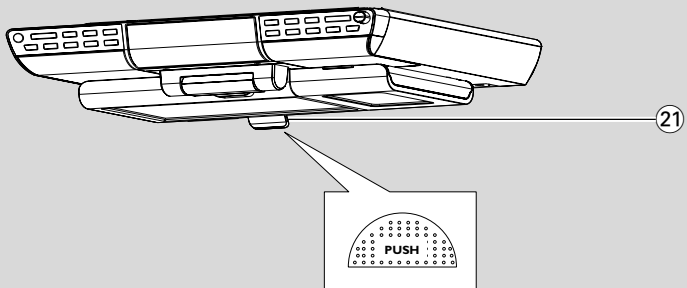
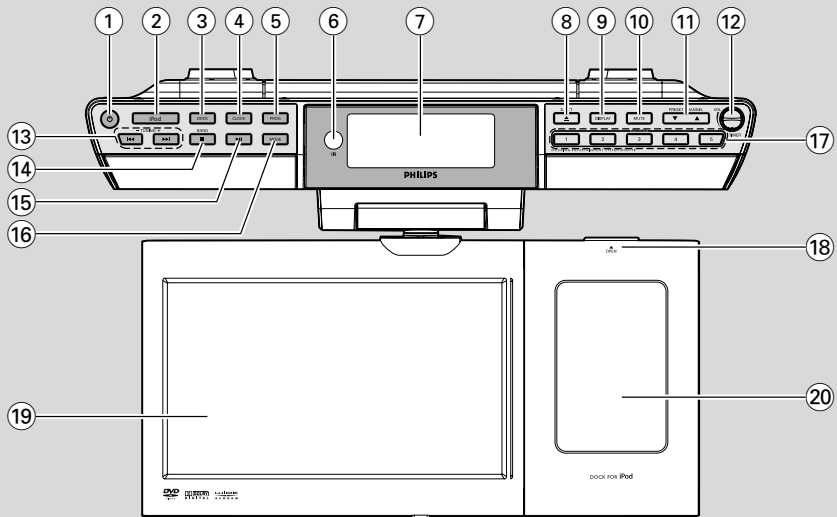

**Return your Product Registration Card or register online at
www.philips.com/usasupport today to get the very most from your purchase.**

Registering your model with PHILIPS makes you eligible for all of the valuable benefits listed below, so don't miss out. Complete and return your Product Registration Card at once, **or register online at www.philips.com/usasupport** to ensure:

***Proof of Purchase**

Returning the enclosed card guarantees that your date of purchase will be on file, so no additional paperwork will be required from you to obtain warranty service.

***Product Safety Notification**

By registering your product, you'll receive notification - directly from the manufacturer - in the rare case of a product recall or safety defect.

***Additional Benefits**

Registering your product guarantees that you'll receive all of the privileges to which you're entitled, including special money-saving offers.

PHILIPS

Congratulations on your purchase, and welcome to the "family!"

Dear PHILIPS product owner:

Thank you for your confidence in PHILIPS. You've selected one of the best-built, best-backed products available today. We'll do everything in our power to keep you happy with your purchase for many years to come. As a member of the PHILIPS "family," you're entitled to protection by one of the most comprehensive warranties and outstanding service networks in the industry. What's more, your purchase guarantees you'll receive all the information and special offers for which you qualify, plus easy access to accessories from our convenient home shopping network.

Most importantly, you can count on our uncompromising commitment to your total satisfaction.

All of this is our way of saying welcome - and thanks for investing in a PHILIPS product.

P.S. To get the most from your PHILIPS purchase, be sure to complete and return your Product Registration Card at once, or register online at:

www.philips.com/usasupport

Know these **safety symbols**



 This "bolt of lightning" indicates unisolated material within your unit may cause an electrical shock. For the safety of everyone in your household, please do not remove product covering.

 The "exclamation point" calls attention to features for which you should read the enclosed literature closely to prevent operating and maintenance problems.

WARNING: To reduce the risk of fire or electric shock, this apparatus should not be exposed to rain or moisture and objects filled with liquids, such as vases, should not be placed on this apparatus.

CAUTION: To prevent electric shock, match wide blade of plug to wide slot, fully insert.

ATTENTION: Pour éviter les choc électriques, introduire la lame la plus large de la fiche dans la borne correspondante de la prise et pousser jusqu'au fond.

For Customer Use

Enter below the Serial No. which is located on the rear of the cabinet. Retain this information for future reference.

Model No. _____
Serial No. _____

PHILIPS

Visit our World Wide Web Site at <http://www.philips.com/usasupport>

IMPORTANT SAFETY INSTRUCTIONS

1. **Read these instructions.**
2. **Keep these instructions.**
3. **Heed all warnings.**
4. **Follow all instructions.**
5. **Do not use this apparatus near water.**
6. **Clean only with dry cloth.**
7. **Do not block any ventilation openings. Install in accordance with the manufacturer's instructions.**
8. **Do not install near any heat sources** such as radiators, heat registers, stoves, or other apparatus (including amplifiers) that produce heat.

9. **Do not defeat the safety**

purpose of the polarized or

grounding-type plug. A polarized plug has two blades with one wider than the other. A grounding type plug has two blades and a third grounding prong. The wide blade or the third prong are provided for your safety. If the provided plug does not fit into your outlet, consult an electrician for replacement of the obsolete outlet.

10. **Protect the power cord** from being walked on or pinched, particularly at plugs, convenience receptacles, and the point where they exit from the apparatus.
11. **Only use attachments/accessories** specified by the manufacturer:

12.  **Use only with the cart**, stand, tripod, bracket, or table specified by the manufacturer or sold with the apparatus. When a cart is used, use caution when moving the cart /apparatus combination to avoid injury from tip-over:

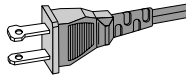

AC Polarized Plug

13. **Unplug this apparatus** during lightning storms or when unused for long periods of time.
14. **Refer all servicing** to qualified service personnel. Servicing is required when the apparatus has been damaged in any way, such as power-supply cord or plug is damaged, liquid has been spilled or objects have fallen into the apparatus, the apparatus has been exposed to rain or moisture, does not operate normally, or has been dropped.

15. **Battery usage CAUTION** – To prevent battery leakage which may result in bodily injury, property damage, or damage to the unit:

Install **all** batteries correctly, **+** and **-** as marked on the unit.

Do not mix batteries (**old** and **new** or **carbon** and **alkaline**, etc.).

Remove batteries when the unit is not used for a long time.

16. **Apparatus shall not be exposed to dripping or splashing.**
17. **Do not place any sources of danger on the apparatus** (e.g. liquid filled objects, lighted candles).
18. This product may contain lead and mercury. Disposal of these materials may be regulated due to environment considerations. **For disposal or recycling information, please contact your local authorities or the Electronic Industries Alliance: www.eiae.org.**

EL 6475-S004: 03/12

Class II equipment symbol 
This symbol indicates that the unit has a double insulation system

Canada

English:

This digital apparatus does not exceed the Class B limits for radio noise emissions from digital apparatus as set out in the Radio Interference Regulations of the Canadian Department of Communications.

Français:

Cet appareil numérique n'émet pas de bruits radioélectriques dépassant les limites applicables aux appareils numériques de Class B prescrites dans le Règlement sur le Brouillage Radioélectrique édicté par le Ministère des Communications du Canada.

Manufactured under license from Dolby Laboratories.

"Dolby", "Pro Logic" and the double-D symbol are trademarks of Dolby Laboratories.

MANUFACTURED UNDER LICENSE FROM DIGITAL THEATER SYSTEMS, INC. US PAT. NO 5,451,942, 5,956,674, 5,974,380, 5,978,762 AND OTHER WORLDWIDE

PATENTS ISSUED AND PENDING. "DTS" AND "DTS DIGITAL SURROUND" ARE REGISTERED TRADEMARKS OF DIGITAL THEATER SYSTEMS, INC. COPYRIGHT 1996, 2000 DIGITAL THEATER SYSTEMS, INC. ALL RIGHTS RESERVED.

This product incorporates copyright protection technology that is protected by method claims of certain U.S. patents and other intellectual property rights owned by Macrovision Corporation and other rights owners. Use of this copyright protection technology must be authorized by Macrovision Corporation, and is intended for home and other limited viewing uses only unless otherwise authorized by Macrovision Corporation. Reserve engineering or disassembly is prohibited.

English 8

Français 38

Español 70

English

Français

Español

CAUTION

Use of controls or adjustments or performance of procedures other than herein may result in hazardous radiation exposure or other unsafe operation.

ATTENTION

L'utilisation des commandes ou réglages ou le non respect des procédures ci-incluses peuvent se traduire par une exposition dangereuse à l'irradiation.

ATENCIÓN

El uso de mando o ajustes o la ejecución de métodos que no sean los aquí descritos puede ocasionar peligro de exposición a radiación.

Contents

General Information

Supplied accessories	9
Environmental information	9
Maintenance	9
Safety information	9

Mounting the Set under a Cabinet

Preparation	10
Mounting the set	10

Installation

Rear connections	11
Connecting FM/AM antennas	
Connecting TV antenna/CATV	
Connecting an additional appliance	
Power supply	12
Before using the remote control	12
Replacing battery (lithium CR2025) into the	
Remote control	12
Setting the clock	13
Using the TV screen	13

Controls

Controls on the set	14
Remote control	15-16

Basic Functions

Switching on/ to standby mode and	
selecting functions	17
Adjusting volume and sound	17
Adjusting volume	
DSC	
Mute	17
Display information	17
Adjusting picture	17

DOCK for iPod

.....	18
-------	----

TV

Watching TV	19
TV Menu Operation	20-22

Radio

Tuning to radio stations	23
Storing preset radio stations	23
Manual programming	
Autostore:Automatic programming	
To listen to a preset station	

Disc Operations

Playable discs	24
Region codes	
Playing discs	24
Selecting and searching	25
Selecting a different track/chapter	
Fast rewinding/forwarding	
GOTO	
Different play modes:REPEAT, SHUFFLE and	
REPEAT A< >B	26
REPEAT	
SHUFFLE	
REPEAT A< >B	
Display information	27
Programming tracks/chapters	27
Playing MP3 disc	28
Playing JPEG Picture CD	28

DVD/VCD Features

INTRO	29
Playing in slow motion	29
ZOOM	29
AUDIO	29
SUBTITLE	29
Using the DISC MENU	29

DVD Setup Menu

To navigate setup options	30
General Setup Page	30
TV Display	
Angle Mark	
OSD Language	
Screen Saver	
Preference Page	31
Parental	
Default	
Password Setup Page	31

Timer

.....	32
-------	----

External AV Source

.....	32
-------	----

Specifications

.....	33
-------	----

Troubleshooting

.....	34-35
-------	-------

Glossary

.....	36
-------	----

This set complies with the FCC rules, Part 15 and with 21 CFR 1040.10.

Operation is subject to the following two conditions:

- **This device may not cause harmful interference, and**
- **This device must accept any interference received, including interference that may cause undesired operation.**

Supplied accessories

- DC 12V adapter
- remote control loaded with CR2025 battery
- 6 iPod Dock adaptors
- Mounting kit: template, 4 spacers, 4 screws

Environmental information

All unnecessary packaging has been omitted. We have tried to make the packaging easy to separate into three materials: cardboard (box), polystyrene and polyethylene (bags, protective foam sheet).

Your system consists of materials which can be recycled and reused if disassembled by a specialized company. Please observe the local regulations regarding the disposal of packaging materials, exhausted batteries and old equipment.

Maintenance

Cleaning the Cabinet

- Use a soft cloth slightly moistened with a mild detergent solution. Do not use a solution containing alcohol, spirits, ammonia or abrasives.

Cleaning Discs

- When a disc becomes dirty, clean it with a cleaning cloth. Wipe the disc from the center out.
- Do not use solvents such as benzene, thinner, commercially available cleaners, or antistatic spray intended for analog records.



Cleaning the disc lens

- After prolonged use, dirt or dust may accumulate at the disc lens. To ensure good playback quality, clean the disc lens with any commercially available cleaner. Follow the instructions supplied with cleaner.

Safety information

- Place the system on a flat, hard and stable surface.
- Where the MAINS plug or an appliance coupler is used as the disconnect device, the disconnect device shall remain readily operable.
- Do not expose the system, batteries or discs to excessive moisture, rain, sand or heat sources caused by heating equipment or direct sunlight.
- Place the system in a location with adequate ventilation to prevent internal heat build-up in your system.
- Install the unit near the AC outlet and where the AC power plug can be easily reached.
- The ventilation should not be impeded by covering the ventilation openings with items, such as newspapers, table-cloths, curtains, etc.
- The apparatus shall not be exposed to dripping or splashing.
- No objects filled with liquids, such as vases, shall be placed on the apparatus.
- No naked flame sources, such as lighted candles, should be placed on the apparatus.
- The mechanical parts of the set contain self-lubricating bearings and must not be oiled or lubricated.
- **When the system is switched to Standby mode, it is still consuming some power. To disconnect the system from the power supply completely, remove the AC power plug from the wall socket.**

Mounting the Set under a Cabinet

Preparation

- Ask a friend to help out. An extra hand to hold the set makes mounting easier and quicker.
 - You may install the unit in the kitchen with or without spacers.
- a Find a mounting location near a wall outlet.

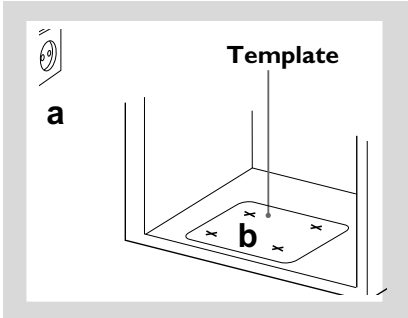

- b Use the mounting template to test the design and thickness of your kitchen cabinet bottom.
- c Decide whether you want to connect the set with other audio/ video equipment.

Mounting the Set

For full details on how to use the Mounting kit, please refer to the printed instructions in the

Quick Start Guide and **Template**.

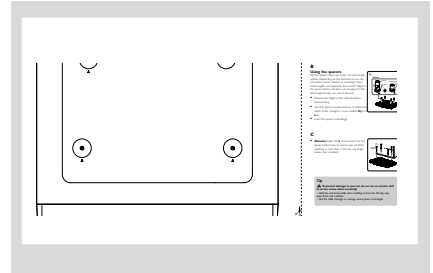

IMPORTANT!

- **Never plug in the AC power cord to the power outlet before installation is completed.**
- **Install the unit near the AC outlet and where the AC power plug can be easily reached.**
- **Do not use a converter or extension cord.**
- **Install the set as far as possible from sources of interference, such as a refrigerator, microwave oven, fluorescent lamp, etc.**
- **There should be at least 2.5" distance between the unit and the wall.**



– **To reduce the risk of fire, do not place any heating or cooking appliance beneath the set, especially while the LCD screen is open or on view.**

Rear connections

Warning:

Never make or change connections with the mains supply switched on.

Connecting FM antenna

It is unnecessary to connect the FM pigtail antenna since it is fixed to the main unit.

- Fully extend the FM antenna.
- Keep the FM antenna as horizontal as possible (as far away as possible from the AC adapter, VCR or other radiation sources).
- Fix the antenna's end to the wall.

Connecting TV antenna/CATV (cables not included)

- As shown, plug a TV antenna (for air channel)/CATV cable (for cable channel) into **TV ANT**.

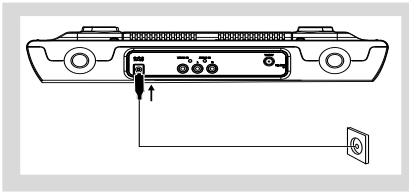

Connecting an additional appliance

It is possible to use an additional appliance, e.g. VCR, video game player, with the set.

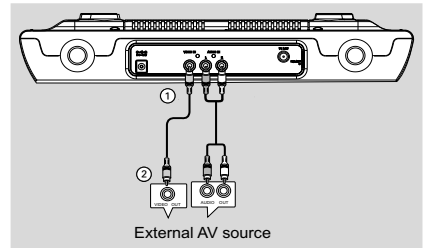

- 1 Connect one end of the AV cable (red/white/yellow, not supplied) to AV IN jacks on the set, red plug to **AUDIO IN R**, white plug to **AUDIO IN L**, yellow plug to **VIDEO IN**.
- 2 Connect the other end of the AV cable to the corresponding AV OUT terminals of the additional appliance.

Before starting operation, press **TV/AV** on the remote control to select "AV" in order to activate the input source.

Helpful hints:

- If the connected device has only a single audio out terminal, connect it to the **AUDIO IN L** terminal. Alternatively, you can use a "single to double" cinch cable, but the output sound will remain mono.
- Always refer to the owner's manual of other equipment for complete connection.

Installation

Power supply

- The type plate is located on the bottom panel.
- Make sure all connections have been made before connecting the power adapter to the wall outlet.

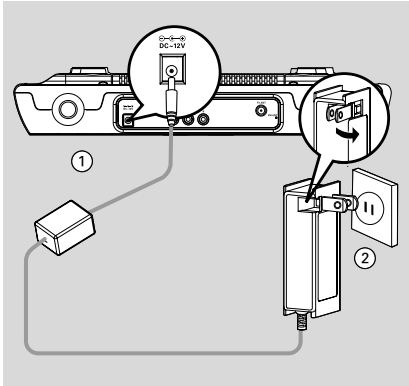

- 1 Insert the DC plug of the supplied power adapter to the DC 12V socket on the back panel.
- 2 Plug the AC plug of the power adapter to the wall outlet.

CAUTION!

- To avoid the hanging power supply cord from touching other heating or cooking apparatus to cause danger, please use the fixer to fasten the cord on the wall or route it away from other appliances when installing the unit.

Before using the remote control

- 1 Pull out the plastic protective sheet.
- 2 Select the source you wish to control by pressing one of the source select keys on the remote control (for example DISC, TUNER).
- 3 Then select the desired function (for example ▶, ◀, ▶|).

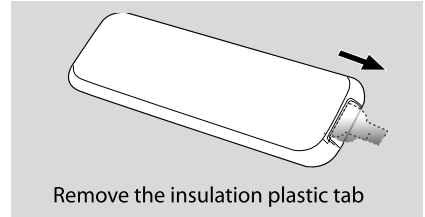

Replacing battery (lithium CR2025) into the remote control

- 1 Push to open the battery tray.
- 2 Replace a new battery according to the indicated polarity.
- 3 Push the battery tray back to close it.

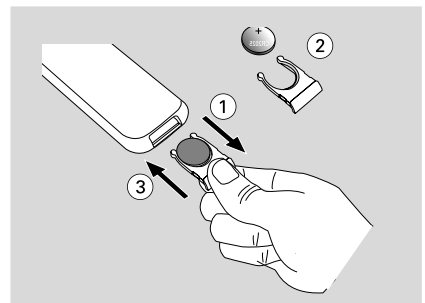

CAUTION!

- Remove battery if it is exhausted or will not be used for a long time.
- Battery contains chemical substances, so they should be disposed of properly.
- Perchlorate Material-special handling may apply. See www.dtsc.ca.gov/hazardouswaste/perchlorate.

Setting the clock

The time is displayed using the 12-hour clock.

- 1 Check the set is switched to standby mode.
(see **Basic Functions, Switch on/to standby**)
→ **---** flashes by default if the clock is not set.
- 2 On the set, press **CLOCK** on the set.
→ The hour digits start flashing (**AM 12: 00** by default).
- 3 Hold down or press **TUNING** **◀▶** (**+ -**) on the set to set the hour. Release **TUNING** **◀▶** (**+ -**) when you have reached the correct setting.
- 4 Press **CLOCK** to confirm the setting.
→ The minute digits start flashing.
- 5 Repeat step 3 to set the minute.
- 6 Press **CLOCK** to confirm the setting.
→ The clock shows the set time.

Helpful hints:

– You may lose your clock setting when the power cord is disconnected or power failure occurs.

Using the TV screen



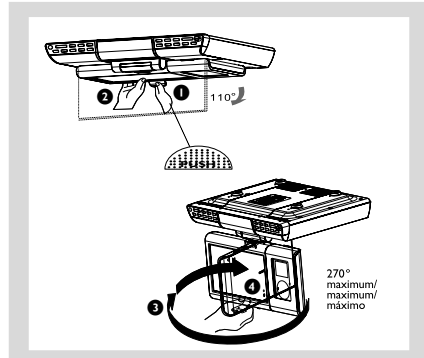



The set is equipped with a 8.5" TFT LCD monitor. You can watch TV on it. If you insert a disc, it will serve as an additional display for messages (e.g. PLAY, STOP), and information stored on the disc.





- 1 Press **PUSH** at the bottom of the set to release TV panel.
- 2 Pull the down the panel (maximum 110°).
- 3 Turn around the panel to find the screen.
- 4 Adjust the screen to a suitable angle (maximum 270°).

Controls on the set (illustrations on page 3)

Front panel

- ①  – switches the set on or to standby mode
- ② **SOURCE**
 - selects functions: DVD (VCD, CD or MP3), TUNER, TV or AV
- ③ **iPod**
 - selects iPod source
- ④ **CLOCK**
 - activates/confirms clock time setting
- ⑤ **PROG**
 - **RADIO/TV:** programs preset stations/channels
- ⑥ **iR (REMOTE SENSOR)**
 - sensor for the infrared remote control
 - Helpful hints: Always point the remote control towards this sensor.*
- ⑦ **LCD display**
 - displays the status of the set
- ⑧  **EJECT**
 - opens/closes the disc tray
- ⑨ **DISPLAY**
 - toggles clock (or timer) display/ status of the set
- ⑩ **MUTE**
 - switches the sound off temporarily
- ⑪  ,  **PRESET / CHANNEL**
 - **RADIO:** selects a preset radio station (down, up)
 - **TV/CATV:** selects a TV channel (down, up)
- ⑫ **VOL / TIMER**
 - adjusts the volume level
 - activates or deactivates timer
 - alarm timer with setting options from 1 to 180 minutes
- ⑬  /  **TUNING +/-**
 - **DVD/VCD/CD:** skips tracks or chapters backward/forward
 - **RADIO:** tunes to radio stations
 - **CLOCK:** adjusts the hour/minute

- ⑭  / **BAND**
 - **DISC:** stops or pauses disc playback
 - **RADIO:** selects wavebands, FM or AM
- ⑮  **II**
 - starts or pauses disc playback.
- ⑯ **MODE**
 - selects different play modes; e.g. REPEAT or SHUFFLE (random order)
- ⑰ **DSC (Digital Sound Control)**
 - selects predefined sound settings: CLASSIC, POP, MOVIE, SPEECH
- ⑱ **PRESET 1/2/3/4/5**
 - **RADIO:** quickly access the stored stations

Bottom panel

- ⑲ **OPEN**
 - pulls to open the dock door.
- ⑲ **TV screen**
- ⑲ **iPod cradle**
 - cradles iPod
- ⑲ **PUSH**
 - push here to release LCD monitor

Rear panel

- ⑲ **DC 12V**
 - socket for the supplied 12V AC/DC adapter
- ⑲ **AV IN**
 - connects to the AV OUT jacks on the external appliance
- ⑲ **TV ANT**
 - connects to the external TV antenna or CATV
- ⑲ **FM pigtail antenna**
 - improves FM reception

Remote control

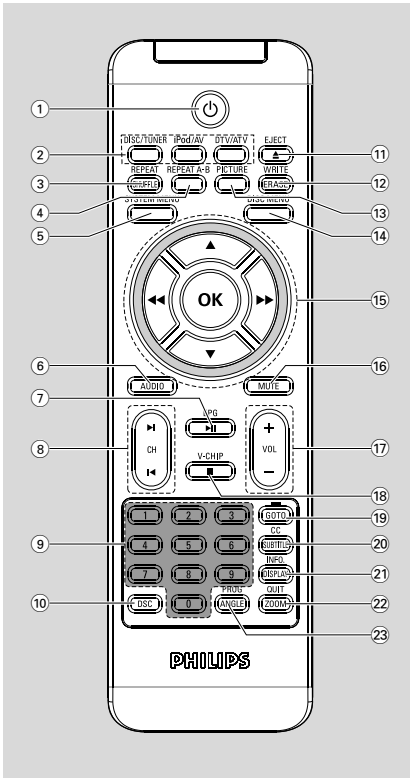

IMPORTANT!

- First, select the source you wish to control by pressing a source button (DISC, RADIO or TV for example).
- Then, select the desired functions (**◀**, **▶**, for example).

- ① **Power**
 - switches the set on or to standby mode
- ② **Source buttons**

DISC / TUNER

 - **DISC:** selects disc functions: DVD, VCD, CD or MP3
 - **RADIO:** selects tuner source

iPod / AV

 - selects iPod source
 - selects the input from an external connected appliance

DTV/ATV

 - selects Digital TV (DTV) or Analog TV (ATV)
- ③ **REPEAT / SHUFFLE**
 - selects play modes of REPEAT or SHUFFLE (random order)
- ④ **REPEAT A-B**
 - repeats a section on a disc
- ⑤ **SYSTEM MENU**
 - enters or exits the system or TV menu.
- ⑥ **AUDIO**
 - selects audio channels or selects a sound track language in a DVD
- ⑦ **EPG / ▶ II**
 - starts/ pause disc playback
 - **DTV:** turns on/off EPG (Electronic Program Guide)
- ⑧ **◀ ▶ CH**
 - **DVD/VCD/CD:** skips tracks or chapters backward/forward
 - **RADIO:** selects a preset radio station (up, down)
 - **TV:** selects a TV channel (up, down)
- ⑨ **Numeric Keypad (0-9)**
 - **DVD/VCD/CD:** selects a track/title/chapter number
 - **TV:** selects a TV channel number
- ⑩ **DSC (Digital Sound Control)**
 - selects predefined sound settings: CLASSIC, POP, MOVIE, SPEECH

Controls

⑪ ▲ EJECT

- opens/closes the disc tray

⑫ ERASE/WRITE

- **TV:** skips a programmed channel, or store a new analog TV channel.

⑬ PICTURE

- toggle to select picture setting options: BRIGHT, CONTRAST, COLOR, TINT

⑭ DISC MENU

- enters or exits the disc content menu

⑮ ▲ / ▼ / ◀ / ▶

- navigation controls (up, down, left, right) to scroll through disc/menu options

◀◀ / ▶▶

- **DISC:** starts fast search backward or forward 2X, 4X, 8X, 16X or 32X
- **RADIO:** tunes to radio stations

OK

- confirms selection

⑯ MUTE

- turns on/off the speaker output.

⑰ VOL +/-

- adjusts the volume level
- adjusts the picture values.

⑱ V-CHIP / ■

- stops playback/ cancels program function.
- **TV:** displays V-Chip password entry

⑲ — / GOTO

- goes directly to desired title, chapter, time or track.
- **DTV:** enables sub-channel number input

⑳ CC / SUBTITLE

- **DVD:** selects a subtitle language
- **TV:** turns on/off TV caption

㉑ INFO. / DISPLAY

- toggles clock (or timer) display/ status of the set

㉒ QUIT / ZOOM

- enlarges or reduces the video image during playback.
- **TV:** goes back to previous on-screen display menu

㉓ ANGLE / PROG

- **RADIO/TV:** programs preset stations/channels
- **VCD/CD:** programs tracks
- views picture from different recorded camera angles (if available on your disc)

Switching on/ to standby and selecting functions

- 1 To switch on, press **POWER**, or press **SOURCE**, or **iPod** (or **DISC/TUNER**, **iPod/AV**, or **DTV/ATV** on the remote control).
→ The system will switch on the last selected source.
- 2 To select your function, press **SOURCE** or **iPod** once or more (or **DISC/TUNER**, **iPod/AV**, or **DTV/ATV** on the remote control).
- 3 Press **POWER** to switch the set to standby.

Helpful hints:

– In the standby mode, the tone, sound settings, tuner presets, and the volume level (up to a maximum volume level of 20) will be retained in the set's memory.

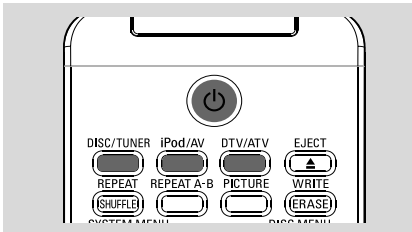

Adjusting volume and sound

Adjusting Volume

- Press **VOL +/-** to adjust the volume.
→ Display shows **VOLUME** and a number from 00 to 32.

DSC

Digital **S**ound **C**ontrol enables you to select predefined sound settings.

- Press **DSC** repeatedly to select your desired sound setting:
→ **CLASSIC**, **POP**, **MOVIE** or **SPEECH** is displayed.

MUTE

During playback, you can temporarily switch off the sound without switching off the set.

- 1 Press **MUTE** to switch off the sound.
→ **MUTE** appears on the TV screen.
Playback continues without sound.
- 2 To switch on the sound, press **MUTE** again or adjust the volume with **VOL** controls.

Display information

- During playback, press **DISPLAY** to switch between the clock/timer display and the status of the set (or on the remote control, **INFO / DISPLAY**).

Adjusting picture

On the TV screen, you can adjust your picture settings: Brightness, Contrast, Color and Tint.

Adjusting picture

On the TV screen, you can adjust your picture settings: Brightness, Contrast, Color and Tint.

- 1 On the remote control, press **PICTURE** once or more to select **BRIGHTNESS**, **CONTRAST**, **COLOR** and **TINT**.
- 2 Press **VOL +/-** to adjust the value between 00 and 32.

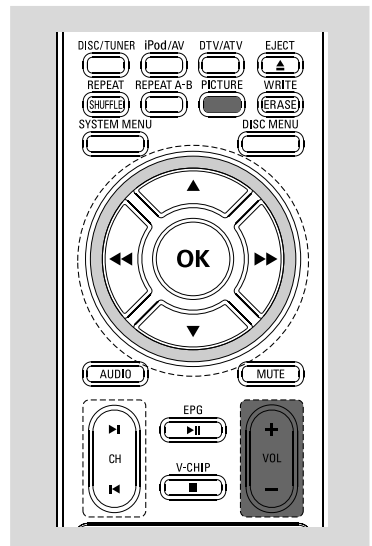

DOCK for iPod

Playing Apple iPod using DCD778

The set is equipped with a dock for iPod. By connecting Apple iPod dock to the set, you can listen to the sound of the docked player through the powerful speakers of the set, and view the iPod video (if available) through the set's LCD.

Compatible iPod player

- Most Apple iPod models with 30-pin dock connector as follows:
20GB, 40GB, 20/30GB Photo, 40/60GB Photo, 30GB Video, 60GB Video, Mini and Nano.
- iPod Shuffle is not supported.

Dock adaptor

Before plugging your player in the dock, snap the suitable adaptor (supplied) into the dock to provide a snug fit for the player to be docked.

Selecting the correct dock adaptor

- 6 iPod dock adaptors are included. Each adaptor has indication to match different iPod types.

Installing the dock adaptor

- 1 Open the dock door as shown below.

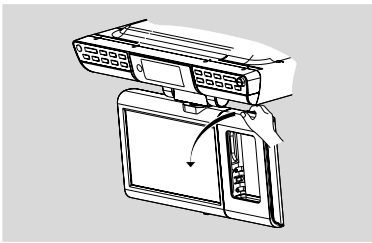

- 2 As the arrow indicated in the figure, fit in the selected adaptor; then gently push the adaptor inward to latch it.

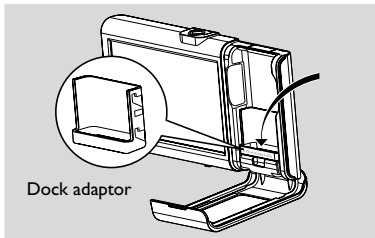

Removing the dock adaptor

- 1 Slightly push up the adaptor to un-latch, then take it out.

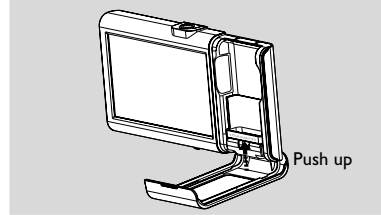

Playing Apple iPod

- 1 Correctly place the iPod in the dock, then close the door.

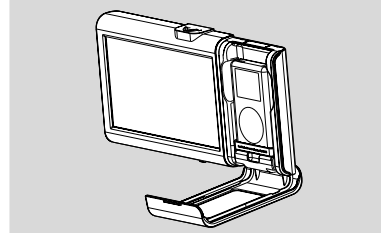

- 2 Press **iPod** on the main unit (or **iPod / AV** on the remote control) .
- 3 Power on your iPod.
- 4 Select and playback your favourite song/video/ photo on the iPod.

Notes:

– Using the following buttons only (▶||, ◀◀ / ▶▶, ◀▶, **VOLUME, DSC, PICTURE** and **MUTE**) on the DCD778 and its remote control, you can control some iPod playback features, such as, Play/ Pause, selecting next/previous track, fast forwarding/rewinding and changing volume. For other iPod operation features (such as menu navigation), use the buttons on your iPod.
– Stop (■) function of disc playback is not available to the docked player.

Charging iPod battery using the dock

In the standby or the iPod mode, you can charge the iPod while docking.

Note:

– iPod charging is not available in **DISC, TUNER** and **TV** mode.

Watching TV

The set can receive both Digital TV (DTV) and Analog TV (ATV).

- 1 Check your TV set has been properly connected and placed. (see **Installation, Connecting TV antenna/CATV** and **Using the TV Screen**)
- 2 Press **DTV / ATV** on the remote control to select DTV (Digital TV) or ATV (Analog TV) (or **SOURCE** on the set).
- 3 Pressing **SOURCE** can select either digital TV or analog TV only, depending on the last selected TV source.
- 3 To receive cable channel, select HRC, IRC or STD through the **TV Menu Operation** on the next page (See "Setting up TV").
- 4 **The first time you use the TV**, press and hold **PROG** until the auto scann progress bar (digital TV or analog TV) appears.

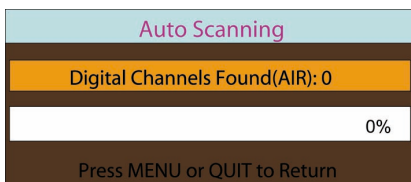

- Available channels (DTV or ATV) are programmed,
 - After all channels are stored, the first autostore channel will then automatically play.
- 5 Press **PRESET / CHANNEL ▲ ▼** to select your desired channel (on the remote control, **◀ ▶ | CH**) or
Use the **Numeric Keypad (0-9)** on the remote control to select the channel number directly, e.g.
Channel 2: Press 0 and then, 2
Channel 10, Press 1 and then, 0
 - For Digital TV, you also need to press **—/GOTO** on the remote control to enable sub-channel selection, then input your desired sub-channel number.

Helpful hints:

– To receive the cable channels, you must connect your TV to the cable TV outlet using a CATV cable (not supplied), and program your TV by select TV source (HRC, IRC or STD) in the TV menu according to your region.

Using EPG (Electronic Program Guide) - Digital TV only

In Digital TV, you can access EPG content which may include program availability, background information, etc..

- 1 In Digital TV, press **EPG** on the remote control to turn on EPG information.
- 2 If necessary, use **▲ / ▼ / ◀◀ / ▶▶** and **OK** on the remote control to select and confirm your selection.
- 3 To turn off EPG, press **EPG** again.

Turning on/off TV caption

- Press **CC / SUBTITLE** once or more to turn on or off TV caption (if available), or display various caption displaying effects.

Selecting audio language (Digital TV only)

- Press **AUDIO** on the remote control to select language spoken on the TV (if available).

Using ERASE/WRITE button on the remote control

To skip a stored channel

- 1 Select the channel you want to skip.
- 2 Press once **ERASE/ WRITE** on the remote control.
→The current channel number appears in red.
- The channel will skip when using **▲** or **▼** to select a TV channel.

To restore a skipped channel to be selectable

- 1 Use the **Numeric Keypad (0-9)** on the remote control to enter the skipped channel number.
- 2 Press **ERASE/ WRITE** on the remote control.
→The skipped channel will be selectable using **▲** or **▼**.

To store a new channel (Analog TV only)

- 1 When a new analog channel is found, use the **Numeric Keypad (0-9)** on the remote control to enter a desired channel number.
- 2 Press **ERASE/ WRITE** on the remote control.
- The new channel will be stored.

TV Menu Operation

Using the TV menu

This TV menu enables you to access the advanced TV features or setup options.

- 1 In TV mode, press **SYSTEM MENU**.
→ The TV menu will appear.
- 2 Press ▲ or ▼ on the remote to select the desired menu page: **Channel** or **Setup**.
- 3 Press ►► to enter the selected menu page.
- 4 Press ▲ or ▼ on the remote to highlight an option.
- 5 To access an option, press ►►.

If sub-options are available, press ►► repeatedly until the desired appears.

If sub-menu needs navigation, use ◀◀/ ▶▶ to select, then press **OK** to confirm.

To return to the upper-level menu

- Press **QUIT** (in cases of value adjustment).

To remove the menu

- Press **SYSTEM MENU** to exit the menu.

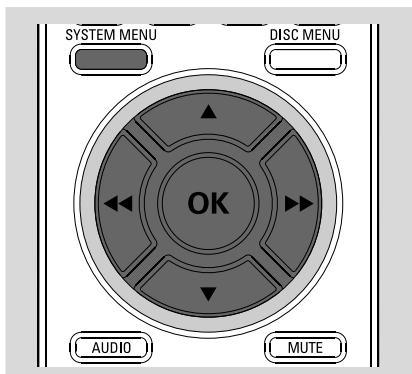

Channel Page

The options included in Channel page are "TV Input", "TV Source", "Auto Program", and "Erase/Write".

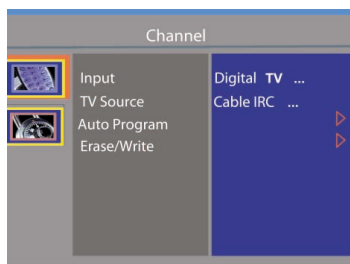

Setting up TV

Set up your TV for the cable or air reception.

- 1 In the Channel page, when **TV Input** is highlighted, press ►► once or more to select Digital TV or Analog TV.
 - 2 In the Channel page, when **TV Source** is highlighted, press ►► repeatedly to select AIR, STD, HRC or IRC.
- To receive the cable channels, select STD, HRC or IRC.
 - To receive air channels, select AIR.

Helpful hints:

– To receive the cable channels, you must connect your TV to the cable TV outlet using a CATV cable (not supplied).

Auto Program

Auto search and store all the available digital or analog channels.

- 1 When Auto Program is highlighted, press ►► to enter its sub-option.
The following message will appear "Do you really want to do it?".
- 2 Use ◀◀/ ▶▶ to select "Yes" or "No", then press **OK** to confirm.
→ If "Yes" is confirmed, the TV will start to search all available DTV or ATV channels.

Skipping TV channel

- 1 In the Channel page, when **Erase/Write** is highlighted, press **▶▶** to enter its sub-menu.

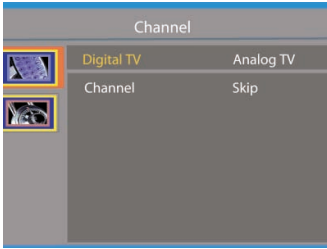

- 2 Press **◀◀ / ▶▶** to select **Digital TV** or **Analog TV** you are in.
- 3 Use **▼** or **▲** to enter Channel and Skip section, or go back to the upper section (Digital TV and Analog TV).
- 4 Use **◀◀ / ▶▶** to select "Channel".
→ The stored TV channels will appear under "Channel" option.
- 5 Use **▲ / ▼ / ◀◀ / ▶▶** to select the desired channel number.
- 6 Use **▲ / ▼ / ◀◀ / ▶▶** to select "Skip", then select "Yes" or "No" to confirm the selection to skip or not.

Setup Page

The options included in Setup page are "Language", "Time", "V-Chip", "Transparent", and "Default Setting".

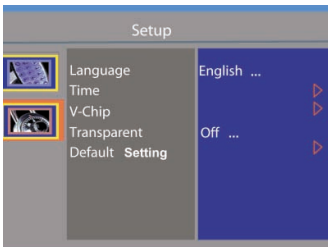

Language

There are three different OSD languages for selection.

- Select **English, French** or **Spanish**

Time Zone (Digital TV only)

The following USA time zones are offered: Central, Mountain, Pacific, Alaska, Hawaii, Atlantic and Eastern.

V-Chip

Using the V-Chip feature, you can put different restriction levels on what your children watch.

To unlock the V-Chip

The V-Chip uses 4-digit numerical password. The default password is **3308**.

- 1 In the **SETUP** page, press **▲** or **▼** to highlight **V-Chip**, then press **▶▶** to enter.
- You may also press **V-CHIP / ■** to bring up the password menu.

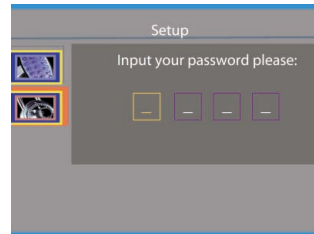

- 2 Use the **Numeric Keypad (0-9)** on the remote control to enter either default password or current password.
→ The V-Chip will be unlocked, and you can enter its sub-menus: **V-Chip Lock, TV Ratings, Movie Ratings, Change PINa and Region Ratings**.

TV Menu Operation

To Change your V-Chip password

- 1 Unlock the V-Chip if locked (See “**Unlock the V-Chip**”).
- 2 In the V-Chip sub-menu, use ▲ or ▼ to highlight **Change PIN**, then press ►► to enter:
→ The message “Enter New PIN” will appear:
- 3 Use the **Numeric Keypad (0-9)** on the remote control to enter your new 4-digit password.
- 4 Enter again the new password to confirm.
→ The password is now changed.

Helpful hints:

– The V-Chip lock can be unlocked by either the default password or the currently set password.

To enable/disable the V-Chip lock

- 1 In the V-Chip sub-menu, use ▲ or ▼ to highlight **V-Chip Lock**.
- 3 Press ►► to select “On” or “Off” to enable or disable the lock.

To set TV ratings

- 1 In the V-Chip sub-menu, use ▲ or ▼ to highlight **TV ratings**, then press ►► to enter:
→ The menu appears
- 2 Use ▲ / ▼ / ◀◀ / ▶▶ to highlight the desired rating, press **OK** to confirm.

To set Movie ratings

The rating options are shown onscreen in descending order of suitability for children. For example, setting a rating at PG-13 will lock out playback of scenes rated PG-13 onwards.

- 1 In the V-Chip sub-menu, use ▲ or ▼ to highlight **Movie Ratings**, then press ►► to enter the options:

G

PG

PG - 13

R

NC - 17.

X

NR

- 2 Press ▲ / ▼ to select your option.
- 3 Press **OK** to confirm.
- To unlock a rating, press **OK** again.

To set Region ratings

This setup is only available for digital TV channel containing the signal of V-Chip 2.0.

- 1 In the V-Chip sub-menu, use ▲ or ▼ to highlight **Region Ratings**, then press ►► to enter the the following options: “**Tumbolia region**”, “**0. Humor Level**”, “**1. Intelligence Level**”.
- 2 When “**0. Humor Level**” or “**1. Intelligence Level**” is highlighted, press ►► repeatedly to select desired sub-options.

Transparent

You can turn on/off the display transparency for the menu by selecting “On” or “Off”.

Miscellaneous

By selecting “Miscellaneous, you can reset the TV menu setups to the default.

Tuning to radio stations

- 1 Press **SOURCE** once or more to select TUNER mode.(or on the remote control, **DISC / TUNER**).
→Display: The waveband, radio station frequency and if programmed, a preset number are shown.
- 2 Press **■ / BAND** on the set once or more to select your waveband: FM or AM.
- 3 Press and hold **TUNING -, +** (or **◀ / ▶** on the remote control) until the frequency in the display starts running.
→ The radio automatically tunes to a station of sufficient reception. Display shows **Srch** during automatic tuning.
- 4 Repeat step 3 if necessary until you find the desired radio station.
- To tune to a weak station, press **TUNING -, +** (or **◀ / ▶** on the remote control) briefly and repeatedly until optimal reception is found.

Storing preset radio stations

You can store up to 30 preset radio stations in the memory (20 FM and 10AM).

Manual programming

- 1 Tune to your desired radio station (see "Tuning to radio stations").
- 2 Press **PROG** to activate programming.
→ Display shows: current radio frequency and **PROG** flashes.
- 3 Press **PRESET / CHANNEL ▲ ▼** to select a preset number (on the remote control, **◀ ▶ CH**)
OR, To store a quick-access station later, press one of **PRESET 1/2/3/4/5** buttons.
- Repeat step 1 to 3 to store other quick access.
- Totally 5 stations can be assigned to quick access.
- 4 Press **PROG** to confirm.
→ Display: **PROG** disappears.
- 5 Repeat steps 1-4 to store other stations.

Helpful hints:

- You can erase a preset station by storing another frequency in its place.

Autostore: automatic programming

Autostore automatically starts programming radio stations from preset 1. Any previous presets e.g. manually programmed will be erased.

- Press and hold **PROG** until **AUTO** appears.
→ Available stations are programmed (20FM and 10 AM).
→ After all stations are stored, the last autostore preset station automatically plays.

To listen to a preset station

- Press **PRESET / CHANNEL ▲ ▼** until the desired preset station is displayed (or on the remote control **◀ ▶ CH**).
Or, press **PRESET 1/2/3/4/5** buttons to quickly access the stored stations.

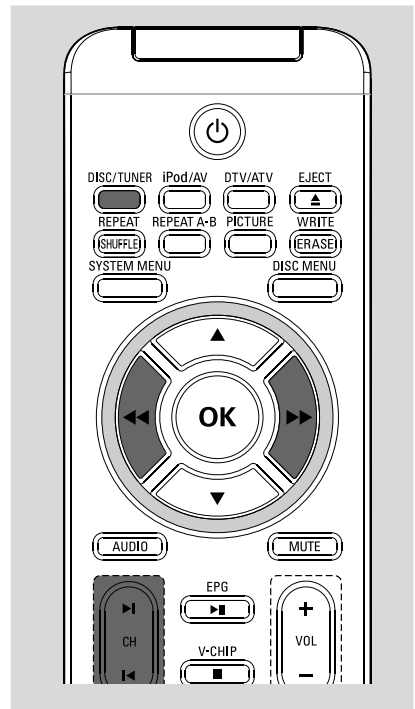

Disc Operations

IMPORTANT!

- Use 12cm discs only!
- The set is designed for regular discs. Therefore, do not use any accessories such as disc stabilizer rings or disc treatment sheets, etc.
- Depending on the format of DVDs or VCDs, some operations may be different or restricted.
- If the inhibit icon  appears on the TV screen when a button is pressed, it means the function is not available on the current disc or at the current time.
- CDs encoded with copyright protection technologies by some record companies may be unplayable on this system.

Playable discs

Your DVD Player will play:

- Digital Video Discs (DVDs).
- Video CDs (VCDs).
- Super Video CDs (SVCDs).
- Digital Video Discs \pm Recordable (DVD \pm R).
- Digital Video Discs \pm Rewritable (DVD \pm RW).
- Compact Discs (CDs).
- MP3 disc on CD-R (W).
- Maximum 16 characters display.
- Supported sampling frequencies: 32 kHz, 44.1 kHz, 48 kHz.
- Supported Bit-rates: 32~192 kbps, variable bitrates.
- Picture (JPEG) files on CD-R(W).
- JPEG/ISO 9660 format.

Region Codes

To play on this DVD player, DVDs must be labelled for **ALL regions** or **Region 1**. You cannot play discs that are labeled for other regions.

Note:

- If you are having trouble playing a certain disc, remove the disc and try a different one. Improper formatted discs will not play on this DVD Player.

Playing discs

- 1 Press **SOURCE** once or more to select DVD mode (or on the remote control, **DISC/TUNER**).
→ You should see the blue Philips DVD background screen on the TV.
- 2 Press **EJECT** to open the disc tray.
- 3 Insert a disc with the print side facing up and close the disc tray.
- 4 Playback will start automatically (depending on the disc type).
→ If a disc menu appears on the screen, use the navigation controls **▲ / ▼ / ◀ / ▶** and press **OK** to select your playback options.
→ If the disc is locked by parental control, see **DVD Setup Menu, PREFERENCE PAGE**.
- 4 To pause playback, press **■**.
- 5 Press **▶ II** to resume playback from the last position.
- 6 To stop playback, press **■** again.
- 7 To remove the disc, press **EJECT**.

Selecting and searching

Selecting a different track / chapter

For DVD/VCD/CD:

- During playback, briefly press ◀◀ / ▶▶

TUNING +/- once or more until your desired track/chapter number appears (or on the remote control, ◀ ▶| **CH**)

or

Use the **Numeric Keypad** (0-9) on the remote control to select the track/chapter number directly. e.g.

Track/chapter 2: Press 0 and then, 2

Track/chapter10, Press 1 and then, 0

For MP3/JPEG:

- Use the navigation controls ◀ / ▶ / ◀◀ / ▶▶ and **OK** to select the desired file or file folder:

Fast backwarding/forwarding

- 1 During playback, press ◀◀ / ▶▶ on the remote control repeatedly to select fast search speed (x2, x4, x8, x16 or x32).
→ The disc plays at a high speed.
- 2 When you recognize the passage you want, press ▶|| or **OK**.
→ Normal playback resumes.

GOTO

- 1 During playback, press **—/GOTO** once or more on the remote control.
→ TV screen shows various search bars in the sequence as follows:

For DVDs:

Title 04/04 Chapter

(used to select chapter number; or title file field using ◀◀ / ▶▶ on the remote control)

Title 04/04 Time

(used to select playtime within the current title)

Chapter 05/24 Time

(used to select playtime within the current chapter)

For VCDs/CDs:

Disc Go To:

(used to select playtime within the entire disc)

Track Go To:

(used to select playtime within the current track)

Select Track:

(used to select a track number within the entire disc)

For MP3:

/196

(used to select a file number within the entire disc)

(used to select playtime within the current file)

- 2 Use the **Numeric Keypad** (0-9) on the remote control to input your title/track/chapter number or playtime.
→ After selecting, playback will automatically start from the selected chapter/track or playtime.

Helpful hints:

- An invalid input value for the current disc will be ignored.

Disc Operations

Different play modes: REPEAT, SHUFFLE and REPEAT A<>B

REPEAT

DVDs:

▶ **CHAPTER:** Repeats current chapter

▶ **TITLE:** Repeats current title

▶ **ALL:** Repeats the entire disc

Audio CDs:

▶ **TRACK:** plays current track repeatedly.

▶ **ALL:** plays all the tracks repeatedly.

MP3/JPEG:

SINGLE: plays a selected file

REPEAT ONE: plays an MP3 file repeatedly or keep a JPEG image still on the screen.

REPEAT FOLDER: plays all files in the selected folder repeatedly.

FOLDER: plays a selected file folder

- 1 During playback, press **REPEAT/SHUFFLE** (or **MODE** on the set) once or more to select play modes.
- 2 To return to normal playback, press **REPEAT/SHUFFLE** (or **MODE** on the set) repeatedly until no more play mode appears.
→ You can also press **■** to cancel your play modes

SHUFFLE

You can play the contents in a disc in a random order.

- 1 During playback, press **REPEAT/SHUFFLE** (or **MODE** on the set) once or more to select or cancel **SHUFFLE** mode
- Shuffle play begins only when the current playback ends.
→ You can also press **■** to cancel your play modes.

MP3 only:

SHUFFLE: plays all files in the selected folder in random order.

FOLDER: plays a selected file folder

- 1 Press **REPEAT/SHUFFLE** (or **MODE** on the set) once or more to select play modes.
- 2 To return to normal playback, press **■** and then, **▶||**.

Repeat A<>B

You can play a certain scene or passage repeatedly.

- 1 During playback, press **REPEAT A-B** on the remote control to mark the start point of the chosen scene or passage.
→ **▶ A** appears in the TV screen.
- 2 Press **REPEAT A-B** again at your chosen end point.
→ **▶ AB** appears.
- 3 To return to normal playback, press **REPEAT A-B** repeatedly until "Repeat A-B" disappears.
→ You can also press **■** to cancel your play modes.

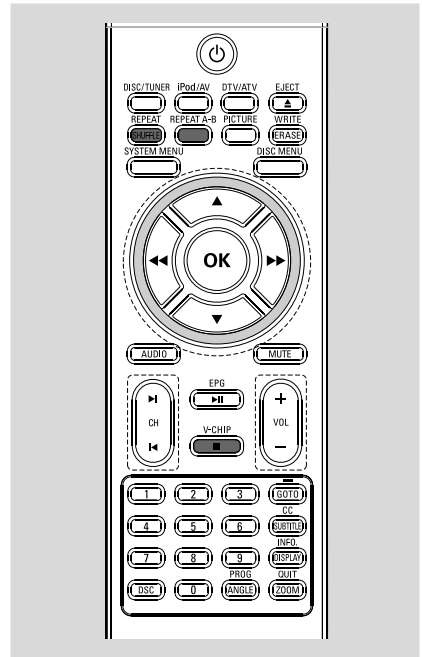

**The REPEAT A-B function can only be set within the same chapter or track.

Display information

During playback, press **DISPLAY/INFO.** on the remote control repeatedly to select your display options:

CDs/VCDs:

Single Elapsed - elapsed playback time of current track.

Single Remain - remaining time of current track.

Total Elapsed - elapsed playback time of disc.

Total Remain - remaining playback time of disc.

DVDs:

Title Elapsed - elapsed playback time of current title.

Title Remain - remaining time of current title.

Chapter Elapsed - elapsed playback time of current chapter.

Chapter Remain - remaining time of current chapter.

**Options available subject to type of disc. Not available for MP3-CDs.

Programming tracks/chapters

You can select and program 20 tracks/ chapters for playback. If you like, store any track/chapter more than once.

CDs/VCDs

- 1 Press **PROG** on the remote control to activate programming mode.
→ The program pop-up appears for you to enter the desired track/chapter numbers.

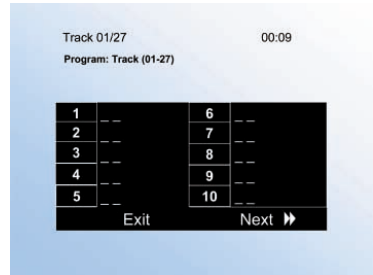

- 2 Use the navigation controls ◀ / ▶ / ◀◀ / ▶▶ on the remote control to select your desired program position.
 - If you need to go the next /previous page to continue programming, navigate to highlight ◀◀ / ▶▶.
- 3 Use the **Numeric Keypad** (0-9) on the remote control to enter your desired track/ chapter number (in 2 digits)
E.g. Track/chapter 7, press 0 and then, 7.
- 4 To start playback, navigate to highlight **START**.
 - If necessary, press **OK** to confirm.

Erasing the program

Either:

- Press **PROG** on the remote control again, or
- Use the navigation controls ◀ / ▶ / ◀◀ / ▶▶ to highlight **EXIT**.
→ The program pop-up disappears.

Playing MP3 disc

- 1 In disc mode, load an MP3/WMA disc.
→ A data disc menu appears on the TV screen.

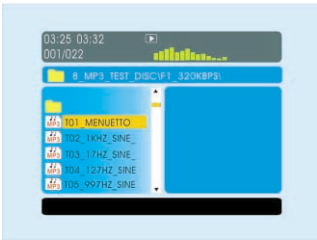

- 2 Press ▲, ▼ to select an album and press ►|| to open it.
- 3 Press ▲, ▼ to highlight a desired track.
 - You may directly use the **Numeric Keypad (0-9)** to input a track number.
- 4 To start playback, press ►||.
- During playback, press ◀◀ / ▶▶ (or |◀▶) on the remote control) to select the next or previous track.
- During playback, press ▲, ▼ to highlight another track, then press ►|| two times to start its playback.

Playing JPEG Picture CD

- 1 Load a JPEG Picture disc.
→ After several seconds of disc loading, pictures will be automatically slide showed on the TV screen at an interval of 4-5 seconds.
 - For the user-made JPEG disc, you may need to press **OK** on the remote control to start slideshow.

To exit slide show

- 1 Press ■.
→ Thumbnail pictures appear on the TV screen.
- You may use ◀ to select a desired picture, then press **OK** on the remote control to display it in a full screen, and slide show will auto start from the selected picture.

Rotating pictures (JPEG)

- During slide show, press ◀ to rotate a picture on the TV screen.
 - ▲: Flip a picture vertically
 - ▼: Flip a picture horizontally
 - ◀◀: Rotate a picture anti-clockwise
 - ▶▶: Rotate a picture clockwise

Zooming pictures (JPEG)

- During slideshow, press **ZOOM** repeatedly to display a picture at enlarged sizes (125%, 150% or 200%) or reduced sizes (75% or 50%).

Use ▲ / ▼ / ◀◀ / ▶▶ to pan across the enlarged picture.

→ Slide show is paused at a zoomed picture, and slide show will resume when the zoomed picture is adjusted to the normal size.

Slide show playback mode (JPEG)

During slide show, press **DISPLAY** repeatedly to select various slide-show playback modes.

ZOOM

Zooming allows you to enlarge or reduce the video/ JPEG image during playback.

- Press **ZOOM** repeatedly to zoom in and out on the playback video image.
→ Image size enlarges at 2X, 3 X, 4 X or reduces at 1/2, 1/3, 1/4.
For JPEG: Image size enlarges at 125%, 150%, 200% or reduces at 50%, 75%.
- To return to normal playback, press **ZOOM** repeatedly until the numbers disappear

AUDIO

DVDs:

- On the remote control, press **AUDIO** repeatedly to select the desired language for sound track

VCDs/CDs:

- Press **AUDIO** repeatedly to select the audio channel for sound output:
MONO LEFT - MONO RIGHT - STEREO

SUBTITLE (DVD only)

- Press **SUBTITLE** on the remote control repeatedly to select different subtitle languages.

Using the DISC MENU

- 1 During playback, press **DISC MENU** on the remote control to enter the disc menu.
- 2 Use the navigation controls ◀ / ▶ / ◀◀ / ▶▶ to select your playback options.
- 3 Press **OK** to confirm.
- 4 Press **DISC MENU** to exit.
** **DISC MENU** available subject to format of disc.

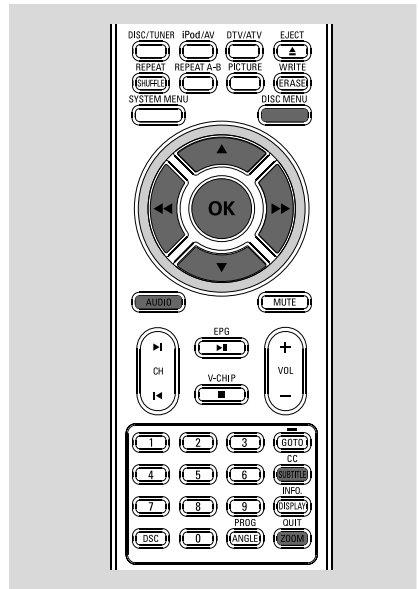

DVD Setup Menu

To navigate setup options

In the stop mode of DVD, use the remote control to select the setup options.

- 1 In the DISC mode, press **SYSTEM MENU** to enter SETUP mode.
- 2 Press **◀ / ▶** to select the desired SETUP page:
General Setup Page, Password Setup Page and Preference Page
- 3 Press **▲ / ▼** to highlight an option.
- 4 Enter its submenu by pressing **▶▶**.
- 5 Move the cursor by pressing **▲ / ▼** to highlight the selected item.
- 6 Press **OK** to confirm.

To return to the upper-level menu

- Press **◀◀** or **QUIT** (in cases of value adjustment).

To remove the menu

- Press **SYSTEM MENU** to exit the menu.

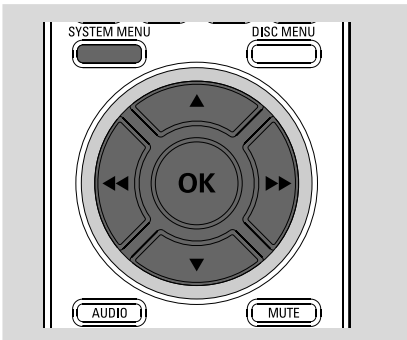

General Setup Page



TV Display (default WIDE)

- Select **PS (Pan and Scan)** for TV display at 4:3 aspect ratio if your DVD is not formatted for widescreen viewing
- Select **LB (Letterbox)** for TV display at 4:3 aspect ratio if your DVD is formatted for widescreen viewing.
- Select **WIDE** for TV display at 16:9 aspect ratio.

Angle Mark (default OFF)

Views picture from different recorded camera angles (if available on your disc).

- Select **ON** or **OFF**.

OSD Language (default English)

There are three different OSD languages for selection.

- Select **English, French** or **Spanish**.

Screen Saver (default ON)

The screen saver appears after 3 minutes in the pause/ stop mode.

- Select **ON** or **OFF**.

Password Setup Page

You can change the PARENTAL password (3308 by default).

To change your password

- 1 In **Password Setup Page**, press ▼ to select **Password**.
- 2 Press ►► to select **Change**.
→ The Password pop-up appears.

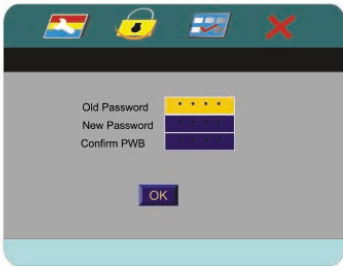

- 3 Use **Numeric Keypad (0-9)** on the remote control to enter your old and new passwords in the 3 boxes.
- 4 Press **OK** to confirm.

Preference Page

Parental

The rating of DVD discs equipped with the child lock function is content-based and varies with different discs. Depending on the particular disc, you can lock out selected scenes or playback of the entire disc.

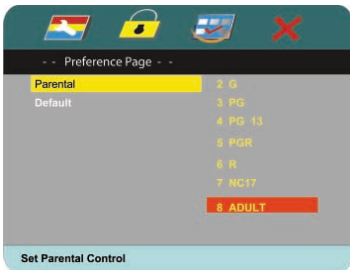

→ The rating options are shown onscreen in descending order of suitability for children.

For example, setting a rating at PG will lock out playback of scenes rated PG-13 onwards.

To set your parental rating

- 1 In **Preference Page**, Press ▼ to select **Parental**.
- 2 Press ►► to enter the options:
KID SAFE
G
PG
PG 13
PGR
R
NC 17
ADULT
- 3 Press ▲ / ▼ to select your option.
- 4 Press **OK** to confirm.
→ The password pop-up appears
- 5 Use the **Numeric Keypad (0-9)** on the remote control to enter your 4-digit password (3308 by default)
- To change the password, see **Password Setup Page**.

Default

You can use this function to reset all settings except for your PARENTAL password.

- 1 Use the navigation controls to select **Default**.
- 2 Press ►► to select **RESET**.
- 3 Press **OK** to confirm.

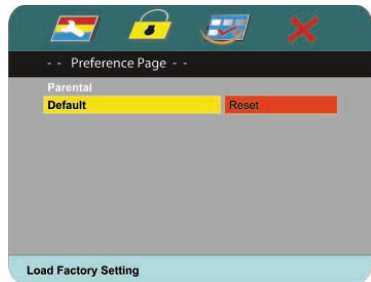

TIMER

Set the timer period to activate a beeper alarm.

Setting the timer

- 1 On the set, press **TIMER** on the set to activate.
→ Display shows **TIMER** and the 0000 digits flashes.
- 2 Turn the **TIMER** control on the set counter-/clockwise to adjust your timer period (from 001 to 180 minutes.)
- 3 Press **TIMER** again (within 90 seconds) to confirm.
→ Timer period starts to count down.

To cancel the timer

Press **TIMER** during the countdown.
→ Clock time appears.

External AV source

It is possible to use an additional appliance, e.g. VCR, video game player, with the set.

- 1 Check the external appliance has been properly connected (see **Installation, Connecting an additional appliance**).
- 2 Press repeatedly **SOURCE** to select AV source (or on the remote control, **⏻** and **iPod/AV**).
- 3 To avoid noise distortion, turn down the volume on your external device.
- 4 Press the **PLAY** key on the connected appliance to start playback.
- 5 To adjust the sound and volume, use the sound controls on your external equipment and the DCD778.

DISC PLAYER

LCD screen size	8.5 inches
Laser wavelength	
..... (CD) 790 + 20nm /(DVD) 655+ 15nm	
Video system	NTSC
Video resolution	> 250 lines
Video signal-to-noise	60dB
Frequency response	20Hz~20kHz
Audio signal-to-noise	≥ 60dB
Audio distortion + noise	≤ 65 dB (1kHz)
Channel separation	≥ 45dB (1kHz)
Dynamic range	70dB

Radio

System	PLL
Frequency range	
AM	530~1700 kHz
FM	87.5~108 MHz

GENERAL

Power	AC100V~240V, 50/60Hz
Power consumption	~ 30W
Dimension	369mmx290mmx91mm (W/H/D)
.....	14.5" x 11.4" x 3.6" (W/H/D)
Weight	About 6lb

Philips reserves the right to make design and specification changes for product improvement without prior notice.

Troubleshooting

WARNING

Under no circumstances should you try to repair the system yourself, as this will invalidate the warranty. Do not open the system as there is a risk of electric shock.

If a fault occurs, first check the points listed below before taking the system for repair. If you are unable to remedy a problem by following these hints, consult your dealer or PHILIPS for help.

Problem	Solution
Disc cannot play	<ul style="list-style-type: none">✓ Make sure a disc is loaded.✓ Make sure a disc is loaded with the label side up.✓ Disc dirty or damaged. Clean the disc.✓ Make sure the region code of the player is the same as that of the DVD disc loaded.✓ Moisture has condensed in the player. Remove the disc and leave the player power-on until the moisture evaporates.
No sound	<ul style="list-style-type: none">✓ Check whether the set is connected securely.✓ Make sure the set is not in the MUTE mode. If it is, press MUTE to turn on the speaker.✓ Check whether the volume on the set has been set to the lowest level. If it has, turn up the volume.
No picture	<ul style="list-style-type: none">✓ Check whether the set is connected securely.
Remote control does not work	<ul style="list-style-type: none">✓ First, select the source you wish to control by pressing a source button (DVD, RADIO or TV for example). Then, select the desired functions (◀, ▶, for example).✓ Remove obstacles between the remote control and the player; and point directly instead of at a wide angle at the infrared sensor on the player.✓ Make sure the battery has been inserted properly (check polarity).✓ Battery maybe exhausted. Replace the battery with a new one.
Radio reception is poor.	<ul style="list-style-type: none">✓ If the signal is too weak, adjust the antenna or connect an external antenna for better reception.✓ Increase the distance between the set and a TV, VCR or radiation source.
The Clock setting is erased.	<ul style="list-style-type: none">✓ Power has been interrupted or the power cord has been disconnected. Reset the clock.

Cable channels cannot be received

- ✓ Program your TV for cable reception through TV menu operation.
- ✓ Make sure that your TV is connected to the cable outlet, and that the cable is securely attached.

The menu navigation of the docked iPod cannot be carried out through the buttons on DCD778 or its remote control.

- ✓ The buttons on DCD778 and its remote control can have some iPod playback features. To navigate the menu, use the controls on the docked iPod.

The STOP ■ and some buttons on DCD778 and its remote control have no function.

- ✓ Only the buttons (▶||, ◀◀ / ▶▶|◀▶|) **VOLUME, MUTE, DSC**) function.

Aspect ratio: The ratio of vertical and horizontal sizes of a displayed image. The horizontal vs. vertical ratio of conventional TVs. is 4:3, and that of wide-screens is 16:9.

Bit Rate: The amount of data used to hold a given length of music; measured in kilobits per second, or kbps. Or, the speed at which you record. Generally, the higher the bit rate better the sound quality. However, higher bit rates use more space on a Disc.

Chapter: Sections of a picture or a music piece on a DVD that are smaller than titles. A title is composed of several chapters. Each chapter is assigned a chapter number enabling you to locate the chapter you want.

Disc menu: A screen display prepared for the selection of images, sound, subtitles, multi-angles, etc recorded on a DVD.

JPEG: A still-picture data compression system proposed by the Joint Photographic Expert Group, which features small decrease in image quality in spite of its high compression ratio.

MP3: A file format with a sound data compression system, "MPE" is the abbreviation of Motion Picture Experts Group 1 (or MPEG-1) Audio Layer 3. Through the MP3 format, one CD-R or CD-RW can contain about 10 times as much data volume as a regular CD can.

Parental control: A function of the DVD to limit playback of the disc by the age of the users according to the limitation level in each country. The limitation varies from disc to disc; when it is activated, playback will be prohibited if the software's level is higher than the user-set level.

Region code: A system allowing discs to be played only in preset regions. This unit will only play discs that have compatible region codes. You can find the region code of your unit from the product label. Some discs are compatible with more than one region (or ALL regions).

Title: The longest section of a picture or music feature on DVD, music, etc., in video software, or the entire album in audio software. Each title is assigned a title number enabling you to locate the title you want.

PHILIPS LIMITED WARRANTY ONE (1) YEAR

WARRANTY COVERAGE:

PHILIPS warranty obligation is limited to the terms set forth below.

WHO IS COVERED:

Philips warrants the product to the original purchaser or the person receiving the product as a gift against defects in materials and workmanship as based on the date of original purchase ("Warranty Period") from an Authorized Dealer. The original sales receipt showing the product name and the purchase date from an authorized retailer is considered such proof.

WHAT IS COVERED:

The Philips warranty covers new products if a defect arises and a valid claim is received by Philips within the Warranty Period. At its option, Philips will either (1) repair the product at no charge, using new or refurbished replacement parts, or (2) exchange the product with a product that is new or which has been manufactured from new, or serviceable used parts and is at least functionally equivalent or most comparable to the original product in Philips current inventory, or (3) refund the original purchase price of the product.

Philips warrants replacement products or parts provided under this warranty against defects in materials and workmanship from the date of the replacement or repair for ninety (90) days or for the remaining portion of the original product's warranty, whichever provides longer coverage for you. When a product or part is exchanged, any replacement item becomes your property and the replaced item becomes Philips' property. When a refund is given, your product becomes Philips' property.

Note: Any product sold and identified as refurbished or renewed carries a ninety (90) day limited warranty.

Replacement product can only be sent if all warranty requirements are met. Failure to follow all requirements can result in delay.

WHAT IS NOT COVERED - EXCLUSIONS AND LIMITATIONS:

This Limited Warranty applies only to the new products manufactured by or for Philips that can be identified by the trademark, trade name, or logo affixed to it. This Limited Warranty does not apply to any non-Philips hardware product or any software, even if packaged or sold with the product. Non-Philips manufacturers, suppliers, or publishers may provide a separate warranty for their own products packaged with the bundled product.

Philips is not liable for any damage to or loss of any programs, data, or other information stored on any media contained within the product, or any non-Philips product or part not covered by this warranty. Recovery or reinstallation of programs, data or other information is not covered under this Limited Warranty.

This warranty does not apply (a) to damage caused by accident, abuse, misuse, misapplication, or non-Philips product, (b) to damage caused by service performed by anyone other than Philips or Philips Authorized Service Location, (c) to a product or a part that has been modified without the written permission of Philips, or (d) if any Philips serial number has been removed or defaced, or (e) product, accessories or consumables sold "AS IS" without warranty of any kind by including refurbished Philips product sold "AS IS" by some retailers.

This Limited Warranty does not cover:

- Shipping charges to return defective product to Philips.
- Labor charges for installation or setup of the product, adjustment of customer controls on the product, and installation or repair of antenna systems outside of the product.
- Product repair and/or part replacement because of improper installation, connections to improper voltage supply, abuse, neglect, misuse, accident, unauthorized repair or other cause not within the control of Philips.
- Damage or claims for products not being available for use, or for lost data or lost software.
- Damage occurring to product during shipping.
- A product that requires modification or adaptation to enable it to operate in any country other than the country for which it was designed, manufactured, approved and/or authorized, or repair of products damaged by these modifications.
- A product used for commercial or institutional purposes (including but not limited to rental purposes).
- Product lost in shipment and no signature verification receipt can be provided.
- Failure to operate per Owner's Manual.

TO OBTAIN ASSISTANCE IN THE U.S.A., PUERTO RICO, OR U.S. VIRGIN ISLANDS...

Contact Philips Customer Care Center at:
1-888-PHILIPS (1-888-744-5477)

TO OBTAIN ASSISTANCE IN CANADA...

1-800-661-6162 (French Speaking)
1-888-PHILIPS (1-888-744-5477) - (English or Spanish Speaking)

REPAIR OR REPLACEMENT AS PROVIDED UNDER THIS WARRANTY IS THE EXCLUSIVE REMEDY FOR THE CONSUMER. PHILIPS SHALL NOT BE LIABLE FOR ANY INCIDENTAL OR CONSEQUENTIAL DAMAGES FOR BREACH OF ANY EXPRESS OR IMPLIED WARRANTY ON THIS PRODUCT. EXCEPT TO THE EXTENT PROHIBITED BY APPLICABLE LAW, ANY IMPLIED WARRANTY OF MERCHANTABILITY OR FITNESS FOR A PARTICULAR PURPOSE ON THIS PRODUCT IS LIMITED IN DURATION TO THE DURATION OF THIS WARRANTY.

Some states do not allow the exclusions or limitation of incidental or consequential damages, or allow limitations on how long an implied warranty lasts, so the above limitations or exclusions may not apply to you.

This warranty gives you specific legal rights. You may have other rights which vary from state/province to state/province.

Philips, P.O. Box 671539, Marietta, GA. 30006-0026

3121 233 48801

PHILIPS CONSUMER ELECTRONICS NORTH AMERICA

P.O. BOX 671539, Marietta, GA. 30006-0026

Meet Philips at the Internet
<http://www.philips.com/usasupport>

English

Français

Español

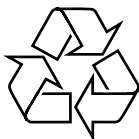

DCD778



Printed In China

PDCC-JH-0707