

## All-In-One Photo Printer with 1.9" Color LCD Display.

- Maximum 4800 x 1200 color dpi with microscopic droplets as small as 2 picoliters
- Print, copy and scan photos and documents quickly and easily
- ChromaLife100 system with FINE technology for long lasting, photo lab quality printing
- Optimal copy and reprint quality with Dual Color Gamut Processing Technology



### Product Specifications

#### PRINTER

##### Type

Color Bubble Jet

##### Print Speed\*

Black: Up to 22 ppm  
(as fast as 2.8 seconds per page)  
Color: Up to 17 ppm  
(as fast as 3.6 seconds per page)  
4" x 6" borderless photo: approx. 52 secs

##### Number of Nozzles

Black: 320  
Color: 384 x 3 (CMY)

##### Print Resolution (Up to)\*\*

Black: 600 x 600 dpi  
Color: 4800 x 1200 dpi

#### INTERFACE

USB 2.0 Hi-Speed\*\*\*  
Direct Print Port  
IrDA 1.2 (JPEG Only)<sup>†</sup>  
Bluetooth Ver. 1.2 (Optional)

#### COPY

##### Copy Speed\*

Black: Up to 22 cpm  
Color: Up to 17 cpm

##### Reduction/Enlargement

25% to 400%

##### Copy Features

Auto Magnification, AE (Auto Exposure),  
Borderless, Multiple Copy: 1-99,  
Fit-to-Page, Image Repeat

#### SCAN

##### Scanning Element

CIS

##### Scanning Element

1200 x 2400 dpi (Optical)  
19,200 x 19,200 dpi (Interpolated)

##### Max. Color Depth

48-bit internal

##### Maximum Document Size

8.5" x 11.7"

#### PAPER

##### Paper Sizes

Letter, Legal, Credit Card (2.13" x 3.39"),  
4" x 6", 4" x 8", 5" x 7", 8" x 10", U.S. #10  
Envelopes, Photo Stickers

#### DIRECT PRINT PHOTO CARD SLOT

##### Compatible Direct Print Photo Cards<sup>††</sup>

CompactFlash<sup>®</sup>, SmartMedia<sup>®</sup>, SD<sup>™</sup> Card,  
Memory Stick<sup>®</sup>, Memory Stick<sup>®</sup> Duo<sup>™</sup>,  
Memory Stick Pro<sup>™</sup>, Memory Stick<sup>®</sup> Pro Duo<sup>™</sup>,  
MultiMediaCard (V3.31), Microdrive<sup>®</sup>,  
xD-Picture Card<sup>™</sup> and miniSD<sup>™</sup> card

#### WINDOWS<sup>®</sup> & MACINTOSH<sup>®</sup> SOFTWARE

##### Setup CD For Windows

MP Driver, MP Navigator, Easy-PhotoPrint,  
Easy-WebPrint (Windows requires Microsoft<sup>®</sup>  
Internet Explorer version. 5.5, version 6.0  
recommended), Arcsoft<sup>®</sup> PhotoStudio<sup>®</sup>,  
ScanSoft<sup>®</sup> OmniPage<sup>®</sup> SE

##### Setup CD For Macintosh OS<sup>®</sup> X

MP Driver, MP Navigator, Easy-PhotoPrint,  
ArcSoft<sup>®</sup> PhotoStudio<sup>®</sup>, ScanSoft<sup>®</sup> OmniPage<sup>®</sup>  
SE

#### DRIVER SYSTEM REQUIREMENTS

USB 2.0 Hi-Speed***	Windows XP (SP1, SP2), Windows 2000 Professional (SP4)	Pentium III, Celeron 566 Mhz	128 MB RAM
USB	Windows XP (SP1, SP2), Windows 2000 Professional (SP2, SP3, SP4), Windows ME, Win 98, Win 98 SE	Pentium II 300 Mhz	128 MB RAM
USB 2.0 Hi-Speed*** or USB	Mac OS X v 10.4	Intel Processor, Power PC G3, G4, G5	256 MB RAM
USB 2.0 Hi-Speed*** or USB	Mac OS X v 10.2.8-10.3	Intel Processor, Power PC G3, G4, G5	128 MB RAM

#### WARRANTY

Toll-free telephone support. 1-Year Limited Warranty. Subject to certain terms and conditions. See [www.canontechsupport.com](http://www.canontechsupport.com) for details.

#### BOX CONTENTS

PIXMA<sup>™</sup> MP460 Photo All-In-One  
Power Cord  
FINE Cartridges:  
PG-40 Black  
CL- 41 Color  
Easy Setup Instructions  
Document kit:  
Setup Software & User's Guide CD-ROM  
Registration Card  
Cross Sell Sheet

#### Specifications are subject to change without notice.

\*PPM print speeds are based on the highest speed printer driver mode using black and white and color text patterns. Photo print speeds are based on the default driver setting using photo test pattern(s) and Canon Photo Paper Plus Glossy paper. Print speed measured as soon as first page begins to feed into printer and will vary depending on system configuration, interface, software, document complexity, print mode, types of paper used and page coverage. See [www.usa.canon.com/printspeed](http://www.usa.canon.com/printspeed). CPM copy speeds are based on fast mode setting using plain paper. Copy speeds may vary based on document complexity, copy mode, page coverage and number of copies.

\*\*Resolution may vary based on printer driver settings. Color ink droplets can be placed with a horizontal pitch of 1/4800 inch at a minimum.

\*\*\*USB 2.0 Hi-Speed performance requires Windows XP Service Pack 1, Windows 2000 Service Pack 4 or Mac OS X v 10.2.8 or later with pre-installed USB 2.0 port.







<sup>†</sup>JPEG files 3MB or smaller only. Requires mobile phone with IrDA port and support for IrMC version 1.1 protocol, with phone positioned no more than 7.9 inches from printer.

<sup>††</sup>xD-Picture Card<sup>™</sup>, Memory Stick Duo<sup>™</sup>, Memory Stick PRO Duo<sup>™</sup>, RS-MMC<sup>™</sup> (V3.31) and mini SD<sup>™</sup> Card requires an additional adapter which must be purchased separately.



# PIXMA MP460 Photo All-In-One

## Ordering Information

MODEL NO.	DESCRIPTION	ITEM NO.	UPC CODE
PIXMA™ MP460	Photo All-In-One	1449B002	 0 13803 06644 9
<b>SUPPLIES</b>			
PG-40	Black FINE Cartridge	0615B002	 0 13803 05125 4
CL-41	Color FINE Cartridge	0617B002	 0 13803 05127 8
PG-50	Black FINE Cartridge-High Capacity	0616B002	 0 13803 05126 1
CL-51	Color FINE Cartridge-High Capacity	0618B002	 0 13803 05128 5
PG-40, CL-41 & Photo Paper Glossy Combo Pack	One PG-40 Black, CL-41 Color and One Photo Paper Glossy 4x6 (50) PK	0615B009	 7 50845 83139 9
BU-20	Bluetooth Adapter	0689B002	 0 13803 05543 6

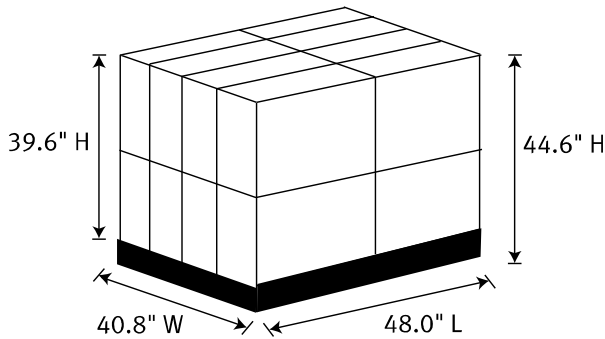
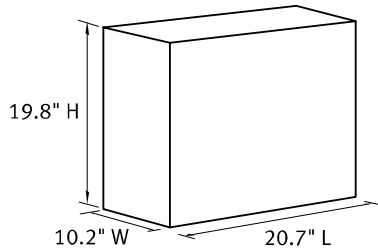

16 Boxes in a pallet

## Pallet Information

### ORIGIN

Country of origin.....Vietnam  
Tariff number.....8471606400

### PRODUCT INFORMATION

Individual box dimensions..... 20.7" L x 10.2" W x 19.8" H  
Individual printer dimensions.....17.5" W x 16.5" D x 7.3" H  
Weight of individual box..... 16.3 lbs.  
Weight of individual printer.....15.7 lbs.

### PALLET INFORMATION

Number of boxes per pallet.....16  
Pallet dimensions (pallet and boxes).....48.0" L x 40.0" W x 44.6" H  
Dimensions without pallet.....41.4" L x 40.8" W x 39.6" H  
Pallet weight with product boxes.....295.8 lbs.

### DATES

Availability.....Week of July 24, 2006



## Specifications are approximate and subject to change without notice.

©2006 Canon U.S.A., Inc. Canon is a registered trademarks and PIXMA is a trademark of Canon Inc. in the United States and may be registered trademarks or trademarks in other countries. Microsoft, Windows and Windows logo are trademarks or registered trademarks of Microsoft Corporation in the United States and/or other countries. Mac and the Mac logo are registered trademarks of Apple Computer, Inc., registered in the U.S. and other countries. SmartMedia is a trademark of Toshiba Corporation. Memory Stick, Memory Stick PRO, Memory Stick Duo and Memory Stick PRO Duo are trademarks of Sony Corporation. xD-Picture Card is a trademark of Fuji Photo Film Co., Ltd. SD Memory Card and miniSD Card are trademarks of SD Association. MultiMediaCard is a trademark of Infineon Technologies AG. IrDA Feature Trademark is owned by the Infrared Data Association and used under license therefrom. Bluetooth is a trademark of Bluetooth SIG, Inc., U.S.A. and is licensed to Canon Inc. ©ArcSoft, Inc. All rights reserved for PhotoStudio. The USB-IF logos are trademarks of trademarks of Serial Bus Implementer Forum, Inc. As an ENERGY STAR® partner, Canon U.S.A., Inc. has determined that this product meets the ENERGY STAR® guidelines for energy efficiency. All other product and brand names are trademarks of their respective owners.