

1.	INSTRUCTIONS FOR SAFE AND PROPER USE	22
2.	POSITIONING OF HOB	24
3.	ELECTRICAL CONNECTION	26
4.	GAS CONNECTION	27
5.	ADAPTATION TO DIFFERENT TYPES OF GAS	29
6.	FINAL OPERATIONS	32
7.	USING THE HOB	34
8.	CLEANING AND MAINTENANCE	37

THESE INSTRUCTIONS ARE VALID ONLY FOR END USER COUNTRIES WHOSE IDENTIFICATION SYMBOLS APPEAR ON THE COVER OF THIS MANUAL.



*INSTRUCTIONS FOR THE INSTALLER: these are for the **qualified technician** who must carry out a suitable check of the gas system, install the appliance, set it functioning and carry out an inspection test.*



INSTRUCTIONS FOR THE USER: these contain user advice, description of the commands and the correct procedures for cleaning and maintenance of the appliance.

1. INSTRUCTIONS FOR SAFE AND PROPER USE



THIS MANUAL IS AN INTEGRAL PART OF THE APPLIANCE AND THEREFORE MUST BE KEPT IN ITS ENTIRETY AND IN AN ACCESSIBLE PLACE FOR THE WHOLE WORKING LIFE OF THE COOKING HOB. WE ADVISE READING THIS MANUAL AND ALL THE INSTRUCTIONS THEREIN BEFORE USING THE COOKING HOB. ALSO KEEP THE SERIES OF NOZZLES SUPPLIED. INSTALLATION MUST BE CARRIED OUT BY QUALIFIED PERSONNEL IN ACCORDANCE WITH THE REGULATIONS IN FORCE. THIS APPLIANCE IS INTENDED FOR DOMESTIC USES AND CONFORMS TO CURRENT **REGULATIONS IN FORCE**. THE APPLIANCE HAS BEEN BUILT TO CARRY OUT THE FOLLOWING FUNCTIONS: **COOKING AND HEATING-UP OF FOOD**. ALL OTHER USES ARE CONSIDERED IMPROPER.

THE MANUFACTURER DECLINES ALL RESPONSIBILITY FOR IMPROPER USE.



DO NOT LEAVE THE PACKING IN THE HOME ENVIRONMENT. SEPARATE THE VARIOUS WASTE MATERIALS AND TAKE THEM TO THE NEAREST SPECIAL GARBAGE COLLECTION CENTRE.



IT IS OBLIGATORY FOR THE ELECTRICAL SYSTEM TO BE GROUNDED ACCORDING TO THE METHODS REQUIRED BY SAFETY RULES.



THE PLUG TO BE CONNECTED TO THE POWER CABLE AND THE SOCKET MUST BE THE SAME TYPE AND MUST CONFORM TO CURRENT REGULATIONS.

THE SOCKET MUST BE ACCESSIBLE AFTER THE APPLIANCE HAS BEEN BUILT IN.

NEVER UNPLUG BY PULLING ON THE CABLE.



IMMEDIATELY AFTER INSTALLATION CARRY OUT A BRIEF INSPECTION TEST OF THE COOKING HOB, FOLLOWING THE INSTRUCTIONS BELOW. SHOULD THE APPLIANCE NOT FUNCTION, DISCONNECT IT FROM THE SUPPLY AND CALL THE NEAREST TECHNICAL ASSISTANCE CENTRE.

NEVER ATTEMPT TO REPAIR THE APPLIANCE.



ALWAYS CHECK THAT THE CONTROL KNOBS ARE IN THE POSITION "ZERO" (OFF) WHEN YOU FINISH USING THE HOB.



THE IDENTIFICATION PLATE, WITH TECHNICAL DATA, SERIAL NUMBER AND MARKING IS CLEARLY VISIBLE UNDER THE CASING.

THE PLATE ON THE CASING MUST NOT BE REMOVED.

BEFORE CONNECTING THE DEVICE, MAKE SURE THAT IT HAS BEEN REGULATED FOR THE TYPE OF GAS THAT WILL FEED IT, CHECKING THE LABEL UNDER THE CASING.



DO NOT PUT PANS WITHOUT PERFECTLY SMOOTH AND FLAT BOTTOMS ON THE COOKING HOB GRIDS.



DO NOT USE RECIPIENTS OR GRIDDLE PLATES THAT EXTEND BEYOND THE EXTERNAL PERIMETER OF THE HOB.



THE HOB IS TO BE USED BY ADULTS ONLY. DO NOT LET UNSUPERVISED CHILDREN PLAY WITH THE HOB.



THIS APPLIANCE IS MARKED ACCORDING TO THE EUROPEAN DIRECTIVE 2002/96/EC ON WASTE ELECTRICAL AND ELECTRONIC EQUIPMENT (WEEE).

THIS GUIDELINE IS THE FRAME OF A EUROPEAN-WIDE VALIDITY OF RETURN AND RECYCLING ON WASTE ELECTRICAL AND ELECTRONIC EQUIPMENT.



The manufacturer declines all responsibility for damage to persons or things caused by non-observance of the above prescriptions or by interference with any part of the appliance or by the use of non-original spares.



2. POSITIONING OF HOB



The following operation requires building and/or carpentry work so must be carried out by a competent tradesman.

Installation can be carried out on various materials such as masonry, metal, solid wood or plastic laminated wood as long as they are heat resistant (T 90°C).

NEVER USE SILICONE OR OTHER INSULATING PRODUCTS WHEN INSTALLING THE APPLIANCE; USE ONLY THE RUBBER GASKET PROVIDED.

2.1.1 Attachment to support structure

Create an opening with the dimensions shown in the figure in the top surface of the counter, keeping a minimum distance of **50 mm** from the rear border.

This appliance can therefore be mounted against walls higher than the work surface on condition that a certain distance "X" be kept between the appliance and the wall as shown in the figure so as to avoid damage from overheating.

Make sure there is a minimum of **750 mm** between the hot plate flames and any shelf that may be installed directly above them.

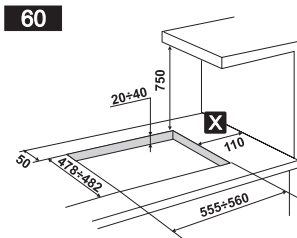

Accurately position the gasket provided all around the outer edge of the hole in the top surface as shown in the figures below, pressing it down so as to make it adhere properly. For measurements, refer to the figure depending on the hob model to be installed, bearing in mind that in both models the front and rear sides must skim the hole. Secure the hob to the counter with brackets **A** (supplied). Carefully trim any excess from border **B** of the gasket. The distances in the following drawing refer to the hole **on the inner side** of the gasket.



Instructions for the installer

NL

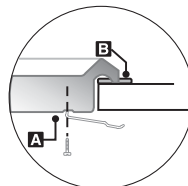
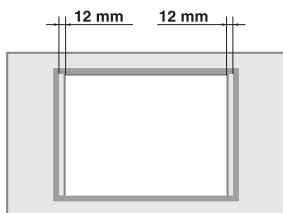

In case of installation on a hollow compartment with doors, a separating panel has to be placed under the hob. Keep a minimum distance of **10 mm** between the bottom of the unit and the panel surface. The panel has to be easily removable to allow access in the event of technical service.

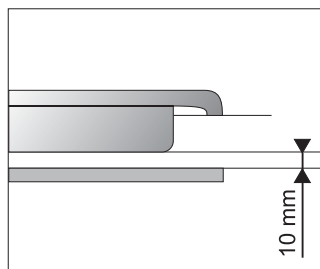
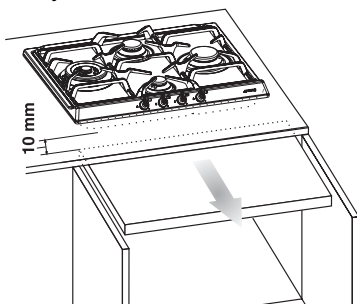



3. ELECTRICAL CONNECTION



Make sure that the voltage and capacity of the power line conform to the data shown on the plate located under the casing. **Do not remove this plate for any reason.**



The plug on the end of the supply cable and the wall socket must be the same type and conform to the current electrical system regulations. Check that the power line is adequately grounded.



On the power line, install an omnipolar cut-off device with contact cut-off distance greater than or equal to **3 mm**, located in an easily accessible position near the unit.



Do not use reducers, adapters or shunts.



If the power cable is replaced, the wire section on the new cable must not be less than 1.5 mm^2 (3 x 1.5 cable), keeping in mind that the end to be connected to the hob must have the ground wire (yellow-green) longer by at least 20 mm. Use only H05V2V2-F cable or similar which has a maximum temperature of 90°C . Any replacement needed should be carried out by a specialised technician who should make the mains connections according to the following diagram.

L = brown

N = blue

 = yellow-green

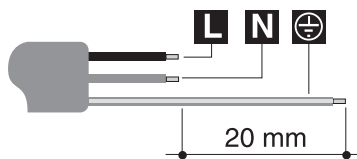

The manufacturer will not be liable for any damage to persons or property caused by non-observance of the above instructions or deriving from the tampering of even a single part of the hob.



4. GAS CONNECTION

Connection to the gas mains may be made with a **rigid copper pipe** or with a **flexible pipe** and conforming to the provisions defined by standard regulations in force.

To facilitate connection, fitting **A** on the rear of the appliance may be adjusted laterally. For this purpose, loosen hexagon nut **B**, turn fitting **A** to the desired position, and retighten hexagon nut **B** (tightness is ensured by a biconical brass ring). Use a soapy solution to check for proper tightness. Never use a free flame.

The hob has been inspected for **G25** (2L 3B/P) at a pressure of 25 mbar. For use with other types of gases, see Section "5. ADAPTATION TO DIFFERENT TYPES OF GAS". The gas intake fitting is 1/2" gas external threaded (ISO 7-1).

Connection with rigid copper pipe:

the connection to the gas mains must not provoke stress of any kind on the hob.

Connection may be made by using biconical adapter **D** with insertion of gasket **C** (supplied).

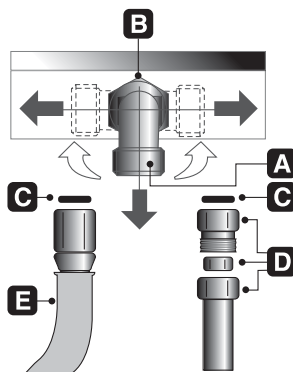

Connection with flexible pipe:

use only flexible pipes conforming to standard regulations in force, inserting gasket **C** (supplied) between fitting **A** and flexible pipe **E**.



The flexible pipe has to be installed so that pipe length does not exceed 1.5 meters of maximum extension. Make sure that the pipes do not touch any moving parts or become damaged.



4.1 Connection to LPG



Use a pressure regulator and make the connection to the tank according to the provisions of standards regulations in force. Make sure that feed pressure conforms to the levels shown in the table in paragraph “5.2 Regulation for LPG”.

4.2 Ventilation of rooms



The hob may be installed only in rooms with permanent ventilation, as required by standards regulations in force. The room in which the hob is installed must have sufficient air flow to satisfy the requirements of normal gas combustion and of necessary air exchange in the room. The air intakes, protected by screens, must be appropriately sized (regulations in force) and placed so as not to be blocked in any way.

The room where the oven is installed should be suitably ventilated to avoid overheating or excess humidity produced by cooking, and in the case of lengthy use a window should be opened or the speed of any ventilators should be increased.

4.3 Discharge of combustion products



Discharge of combustion products must be guaranteed by means of hoods connected to a natural draught flue with certain efficiency, or by means of forced aspiration.

An efficient aspiration system requires careful planning by a specialist capable of installing it, respecting the positions and distances prescribed by standards. After installation, the installer must issue a certificate of conformity.



Instructions for the installer

NL

5. ADAPTATION TO DIFFERENT TYPES OF GAS



Before performing any cleaning or maintenance work, detach the appliance from the electrical socket.

The hob has been inspected for **G25** (2L 3B/P) at a pressure of 25 mbar. For functioning with other types of gas the nozzles must be replaced and the primary air adjusted.

To replace the nozzles and regulate the burners, you have to remove the top as described in the following paragraph.

5.1 Removing the hob

1. Remove all the knobs, the grids, the burner caps and the flame-caps;
2. remove the screws and the nuts **A** that secure the burner supports;
3. lift the hob from its seat;
4. replace the burner nozzles in accordance with the reference gas chart;
5. regulate the primary air as described in paragraph "5.2 Regulation for LPG".





5.2 Regulation for LPG

Loosen screw **A** and push support **B** all the way. Use a double head wrench to remove nozzle **C** and assemble the suitable one, following the instructions indicated in the reference charts, with respect to the type of gas to use. The screwing torque of the nozzle should never exceed **3 Nm**. Reposition support **B** so that nozzle **C** is covered perfectly.

Move the Venturi tube **D** to regulate the air flow until distance "**X**" is reached indicated in the chart in paragraph "5.4 Regulation of primary air" and then secure the tube by means of screw **A**. After the regulations have been carried out, restore the seals with sealing wax or equivalent material.

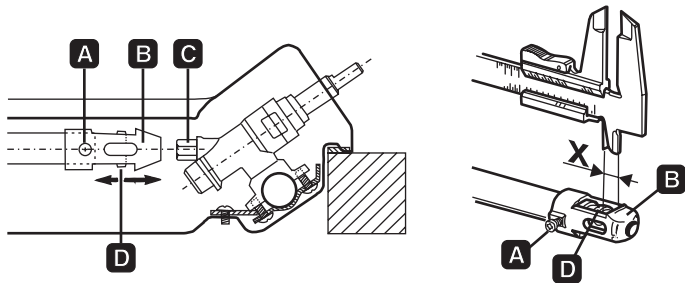

Burner	Rated heating capacity (kW)	LPG – G30/G31 28/37 mbar					
		Nozzle diameter 1/100 mm	By-pass mm 1/100		Reduced flowrate (W)	Flowrate g/h G30	Flowrate g/h G31
Auxiliary (1)	1.05	48	30	33 (*)	380	76	75
Semi-rapid (2)	1.65	62	30	33 (*)	380	120	118
Rapid (3)	2.55	76	37	40 (*)	650	185	182
Rapid (4)	3.1	85	43	45 (*)	750	225	222
Ultra rapid (5)	3.9	95	65		1600	283	279

(*) By-pass value for valveless appliances.



Instructions for the installer



5.3 Regulation for natural gas

The hob has been inspected for **G25** (2L 3B/P) at a pressure of 2 mbar. To allow the unit to work with this type of gas, perform the same operations described in paragraph "5.2 Regulation for LPG", but choose the nozzles and regulate the primary air for natural gas, as shown in the following table and in paragraph "5.4 Regulation of primary air". After the regulations have been carried out, restore the seals with sealing wax or equivalent material.

Burner	Rated heating capacity (kW)	Natural gas – G25 25 mbar	
		Nozzle diameter 1/100 mm	Reduced flowrate (W)
Auxiliary (1)	1.05	76	380
Semi-rapid (2)	1.65	98	380
Rapid (3)	2.7	123	650
Rapid (4)	3.1	130	750
Ultra rapid (5)	3.9	150	1400

5.4 Regulation of primary air

Referred to distance "X" in mm.

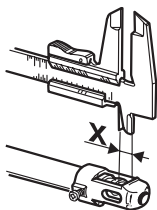

BURNER	G25 25 mbar	G30/G31 28/37 mbar
Auxiliary (1)	1.5	2.0
Semi-rapid (2)	1.0	1.5
Rapid (3)	1.0	5.0
Rapid (4)	1.5	10.0
Ultra rapid (5)	1.5	4.0



6. FINAL OPERATIONS

Having carried out the above adjustments, reassemble the appliance following, backwards, the instructions in paragraph “5.1 Removing the hob”.

6.1 Regulation of minimum for natural gas

Replace the components on the burner and slide the knobs on the gas tap pins.

Light the burner and set it at minimum position.

Remove the knob and turn the regulation screw inside or next to the gas tap pin (depending on the model) until you get a suitable minimum flame.

Replace the knob and check burner flame stability: (rapidly turning the knob from maximum to minimum position, the flame should not go out).

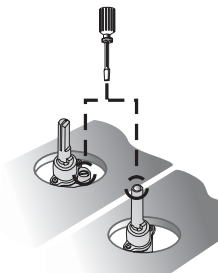

6.2 Regulation of minimum for LPG

To regulate the minimum for LPG, completely tighten (clockwise) the screw inside or next to the gas tap pin (depending on the model).

The diameters of the by-passes for each burner are given in table “5.2 Regulation for LPG”.



After having regulated the device with gas other than the one tested, replace the label located on the guard with the one that corresponds to the new gas. The label is inside the bag that contains the nozzles provided.



6.3 Arrangement of burners on hob

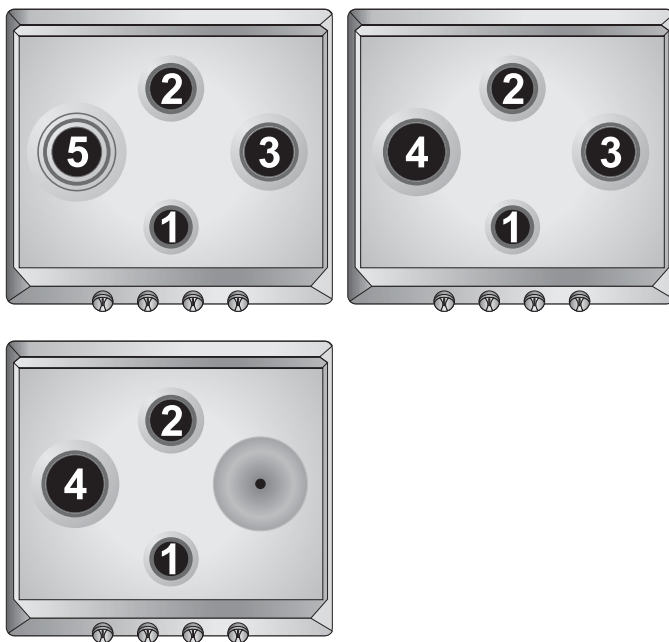

BURNERS

- 1 Auxiliary
- 2 Semi-rapid
- 3 Rapid
- 4 Rapid
- 5 Ultra rapid



6.4 Lubrication of gas taps

After a while, the gas tap may become hard to turn or lock. If this happens, it has to be cleaned inside and re-greased.

This must be done by a qualified technician.



7. USING THE HOB



Before turning on the burners, make sure that the burner rings, caps and grids have been fitted correctly.

In the ultrarapid burner, notch **A** must be aligned with pin **B**.

Grid **C** provided is intended for use with woks (Chinese pans).

Adapter **D** comes only with open grids models and is intended for use with small sized vessels.

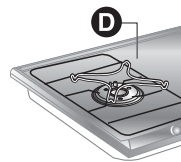
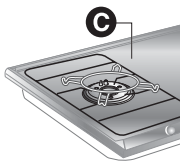
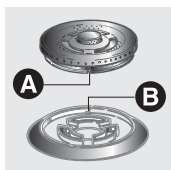

Some models do not feature all accessories.

7.1 Ignition of the burners



For each knob the corresponding burner is indicated. The device is fit with electronic ignition. Simply press and simultaneously turn the knob counter-clockwise on the low point flame symbol, until the burner is ignited. Concerning models with valves, push the knob for approximately 2 seconds in order to keep the flame burning and to activate the safety device. The burner might go off when the knob is released. In this case repeat the aforesaid operation keeping the knob pressed for more than 2 seconds.



Should the burners go off accidentally in the models with valves, a safety device will trip after approximately 20 seconds to block the gas outlet even if the tap is open.



Instructions for the user



7.2 Practical advice for using the burners

For better burner performance and minimum gas consumption, flat bottomed, even recipients must be used, with covers and proportional in size to the burners (see paragraph "7.3 Diameter of containers").

To avoid overcooking or damage to the surface top while cooking, all recipients or griddles must be positioned within the cooking hob perimeter and must be a minimum distance of **3-4 cm** from the knobs.

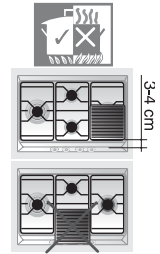

7.3 Diameter of containers



(*)	Burner	Ø min. and max. (in cm)
1	Auxiliary	12-14
2	Semi-rapid	16-24
3	Rapid (3)	18-26
4	Rapid (4)	22-26
5	Ultra rapid	22-26

(*) For burner reference numbers, see page 33.

7.4 Electric elements

7.4.1 Turning on electric elements

Hobs may be fitted with an electric element of varying diameter. The electric element is controlled by a switch and is turned on by rotating the appropriate knob to the desired position.



7.4.2 Using the electric elements

The electric elements are ideal for ultrarapid cooking. The settings shown in the table are merely indicative.

POSITION	HEAT INTENSITY	POSSIBLE COOKING
0	Off	-
1	Weak	To melt butter, chocolate, etc. To heat small amounts of liquid.
2	Soft	To heat larger amounts of liquid.
3	Slow	To defrost frozen food and prepare stews, cooking at or just below boiling point.
4	Medium	To cook food which has to reach boiling point, to roast delicate meat or fish.
5	Strong	For roasts, steaks and large boiled joints.
6	Very strong	To boil large amounts of water, to fry.

WARNING

When switching on the electric element for the first time, or if the electric element has not been used for a long time, to remove any humidity from the insulating material it should be dried out by placing the electric element on position 1 for 30 minutes.

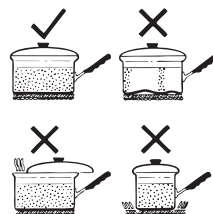

To use correctly remember to:

- Switch the electric element only after having placed the pan on it.
- Use flat and thick bottomed pans.
- Never use pans which are smaller than the electric element.
- Dry the bottom of the pan before placing it on the electric element.
- When cooking with flammable oils and fats, never leave the appliance.
- The electric elements will stay hot for a long time after use: do not touch them or place any objects on them.
- If any dents appear in the electric element surface, switch it off immediately and contact the nearest authorised servicing centre.



Instructions for the user

NL

8. CLEANING AND MAINTENANCE



Before any intervention, disconnect the power supply of the device.

8.1 Cleaning



Clean the cooking top regularly every time you use it, obviously after it has cooled.



NEVER USE A STEAM JET TO CLEAN THE APPLIANCE.

8.1.1 Regular daily cleaning of the hob

In order to clean and preserve the surface, always use specific products **only**, which do not contain abrasive substances or chlorine-based acid substances.

How to use: pour the product on a damp cloth and wipe the surface, rinse thoroughly and dry with a soft cloth or deerskin.

8.1.2 Food stains or residues

Do not use metallic sponges or sharp scrapers: they will damage the surface.

Use normal non-abrasive products and remove spots or residuals with non-scratch sponges or, if need be, with wood or plastic utensils.

Rinse thoroughly and dry with a soft cloth or deerskin.



8.2 Cleaning of cooking hob components

Grids, caps, flame cap crowns and burners can be removed for ease of cleaning. Wash them in warm water using a non-abrasive detergent, taking care to remove all tough spots. Before remounting, allow the components **to fully dry out**.



8.2.1 Ignition plugs and safety devices

For good functioning of the lighting ignition plugs and the safety devices, keep them very clean.

Check frequently and clean with a damp cloth when necessary.



8.2.2 The cover

Clean the glass or steel cover, where mounted, with warm water. Never use abrasive sponges or detergents. To clean the rear part of the cooktop, remove the cover by lifting out.

When finished cleaning, refit the cover making sure to insert it correctly. Before lifting up the cover, dry out properly.

Never lower the cover when burners or electric elements are on or still hot.