

1.	INSTRUCTIONS FOR SAFE AND PROPER USE	42
2.	INSTALLATION OF THE APPLIANCE	44
3.	ADAPTATION TO DIFFERENT TYPES OF GAS	47
4.	FINAL OPERATIONS	49
5.	DESCRIPTION OF CONTROLS	51
6.	USE OF THE COOKING HOB	58
7.	USE OF THE OVENS	59
8.	ACCESSORIES	61
9.	COOKING HINTS	63
10.	CLEANING AND MAINTENANCE	71
11.	EXTRAORDINARY MAINTENANCE	75

THESE INSTRUCTIONS ARE VALID ONLY FOR END USER COUNTRIES WHOSE IDENTIFICATION SYMBOLS APPEAR ON THE COVER OF THIS MANUAL.



*INSTRUCTIONS FOR THE INSTALLER: these are for the **qualified technician** who must carry out a suitable check of the gas system, install the appliance, set it functioning and carry out an inspection test.*



INSTRUCTIONS FOR THE USER: these contain user advice, description of the commands and the correct procedures for cleaning and maintenance of the appliance.

1. INSTRUCTIONS FOR SAFE AND PROPER USE



THIS MANUAL IS AN INTEGRAL PART OF THE APPLIANCE AND THEREFORE MUST BE KEPT IN ITS ENTIRETY AND IN AN ACCESSIBLE PLACE FOR THE WHOLE WORKING LIFE OF THE COOKER. WE ADVISE READING THIS MANUAL AND ALL THE INSTRUCTIONS THEREIN BEFORE USING THE COOKER. ALSO KEEP THE SERIES OF NOZZLES SUPPLIED. INSTALLATION MUST BE CARRIED OUT BY QUALIFIED PERSONNEL IN ACCORDANCE WITH THE REGULATIONS IN FORCE. THIS APPLIANCE IS INTENDED FOR DOMESTIC USES AND CONFORMS TO CURRENT **REGULATIONS IN FORCE**. THE APPLIANCE HAS BEEN BUILT TO CARRY OUT THE FOLLOWING FUNCTIONS: **COOKING AND HEATING-UP OF FOOD**. ALL OTHER USES ARE CONSIDERED IMPROPER.

THE MANUFACTURER DECLINES ALL RESPONSIBILITY FOR IMPROPER USE.



DO NOT LEAVE THE PACKING IN THE HOME ENVIRONMENT. SEPARATE THE VARIOUS WASTE MATERIALS AND TAKE THEM TO THE NEAREST SPECIAL GARBAGE COLLECTION CENTRE.



IT IS OBLIGATORY FOR THE ELECTRICAL SYSTEM TO BE GROUNDED ACCORDING TO THE METHODS REQUIRED BY SAFETY RULES.



IMMEDIATELY AFTER INSTALLATION CARRY OUT A BRIEF INSPECTION TEST OF THE APPLIANCE, FOLLOWING THE INSTRUCTIONS BELOW. SHOULD THE APPLIANCE NOT FUNCTION, SWITCH OFF THE POWER SUPPLY TO THE APPLIANCE AND CALL THE NEAREST TECHNICAL ASSISTANCE CENTRE.

NEVER ATTEMPT TO REPAIR THE APPLIANCE.



ALWAYS CHECK THAT THE CONTROL KNOBS ARE IN THE POSITION  (OFF) WHEN YOU FINISH USING THE HOB.



NEVER PUT INFLAMMABLE OBJECTS INTO AN OVEN: IF THEY CATCH FIRE THEY COULD CAUSE A FIRE IN THE HOME.

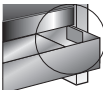

THE I.D. PLATE WITH TECHNICAL DATA, REGISTRATION NUMBER AND BRAND NAME IS POSITIONED VISIBLY IN THE STORAGE COMPARTMENT.

THE PLATE MUST NOT BE REMOVED.



DURING USE THE APPLIANCE BECOMES VERY HOT. TAKE CARE NOT TO TOUCH THE HEATING ELEMENTS INSIDE THE OVEN.



DO NOT INSTALL THIS APPLIANCE ON A RAISED PLATFORM.



DO NOT PUT PANS WITHOUT PERFECTLY SMOOTH AND FLAT BOTTOMS ON THE COOKING HOB GRIDS.



DO NOT USE CONTAINERS OR BROILERS THAT EXTEND BEYOND THE OUTER PERIMETER OF THE HOB.



THE USE OF THIS APPLIANCE IS NOT PERMITTED TO PEOPLE (INCLUDING CHILDREN) OF REDUCED PHYSICAL AND MENTAL ABILITY, OR LACKING IN EXPERIENCE IN THE USE OF ELECTRICAL APPLIANCES, UNLESS THEY ARE SUPERVISED OR INSTRUCTED BY ADULTS OR PEOPLE RESPONSIBLE FOR THEIR SAFETY.



THIS APPLIANCE IS MARKED ACCORDING TO THE EUROPEAN DIRECTIVE 2002/96/EC ON WASTE ELECTRICAL AND ELECTRONIC EQUIPMENT (WEEE).

THIS GUIDELINE IS THE FRAME OF A EUROPEAN-WIDE VALIDITY OF RETURN AND RECYCLING ON WASTE ELECTRICAL AND ELECTRONIC EQUIPMENT.



BEFORE THE APPLIANCE IS PUT INTO OPERATION, ALL THE LABELS AND PROTECTIVE FILMS APPLIED INSIDE OR OUTSIDE MUST BE REMOVED.



The manufacturer declines all responsibility for damage to persons or things caused by non-observance of the above prescriptions or by interference with any part of the appliance or by the use of non-original spares.



2. INSTALLATION OF THE APPLIANCE



*It is the law that all gas appliances are installed by **competent persons**. Corgi gas installers are approved to work to safe and satisfactory standards. All gas installation, servicing and repair work must be in accordance with the gas safety regulations 1984 (installation and use) as amended 1990.*

It can be placed against walls higher than the hob, at a distance of at least 50 mm from the side of the appliance, as shown in the drawings A and B relating to the installation classes. Wall units or extractor hoods located above the hob must be at least 750 mm away from it.



2.1 Positioning and levelling of the appliance



The appliance is equipped with wheels and adjustable feet to simplify the positioning procedure. To use the front wheels, screw in the foot as shown here, so that the appliance rests on the front wheels. However, to allow the appliance to be moved freely it must be lifted at the back. To do this, proceed as follows:

use a 10 socket wrench to screw in the 2 hex nuts underneath the oven compartment: this raises the appliance either to level it or to allow it to be moved around.

Once all procedures are complete, unscrew the front feet and the hex nuts to set the cooker stable and level.

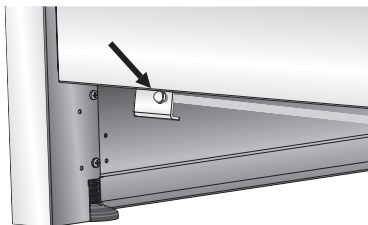

2.2 Electrical connection

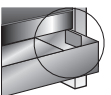

Make sure that the power line voltage matches the specifications indicated on the rating plate located inside the storage compartment.

This rating plate must never be removed.



Instructions for the installer

GB-IE



The connection to the mains shall be done conforming to the regulations in force. Check that the power line is adequately grounded. Do not use reducers, adapters or shunts. On the power line, install an omnipolar cut-off device with contact cut-off distance greater than or equal to **3 mm**, located in an easily accessible position near the unit.

The connection terminals are located at the rear of the appliance. For electrical connections see following diagram. To access, remove the rear cover.

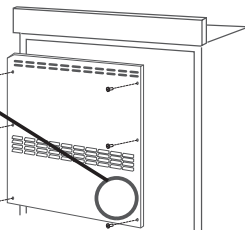

For operation on 380-415V3N~: use an H05RR-F-type five-core cable (5 x 1.5 mm²).

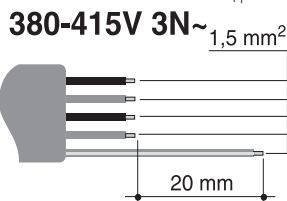

For operation on 380-415V2N~: use an H05RR-F-type four-core cable (4 x 2.5 mm²).

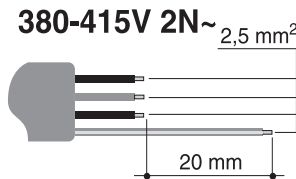

For operation on 220-240V~: use an H05RR-F-type three-core cable (3 x 4 mm²).

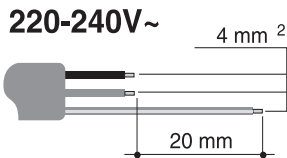

The cable end to be connected to the appliance must be provided with a ground wire (yellow-green) at least 20 mm longer.



The manufacturer declines all responsibility for damage to persons or things caused by non-observance of the above prescriptions or by interference with any part of the appliance.



2.3 Ventilation requirements

The room containing the appliance should have an air supply in accordance with B.S. 5440 part 2 1989.

1. All rooms require an opening window or equivalent, and some rooms will require a permanent vent as well.
2. For room volumes up to 5 m³ an air vent of 100 cm² is required.
3. If the room has a door that opens directly to the outside, and the room exceeds 1 m³ no air vent is required.
4. For room volumes between 5 m³ and 10 m³ an air vent of 50 cm² is required.
5. If there are other fuel burning appliances in the same room B.S. 5440 part 2 1989 should be consulted to determine the air vent requirements.
6. This appliance must not be installed in a bed sitting room of less than 20 m³ or in a bathroom or shower room.

Windows and permanent vents should therefore not be blocked or removed without first consulting a Corgi gas installer.

Failure to install appliances correctly is dangerous and could lead to prosecution.

2.4 Connecting to natural and LPG gas (Please see connection diagram)

Make the connection to the appliance using flexible bayonet style hose in accordance to B.S. 669. The hose connection at the rear of the appliance has a 1/2" BSP internal thread. Please use seal **C** between the flexible connection **L** and the appliance supply tube **B**. When making the connection, make sure that no stress of any kind is applied to the cooker and that the hose does not touch any sharp edges.

If connecting to LPG the bayonet hose must have red bands on it.

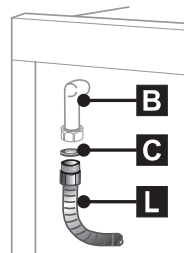

2.5 Instruction for wall fixing (only on some models)

- 1) Fix the screw to the wall and hook the chain (**B**);
- 2) Hook the chain to the hole positioned at the rear of the cooker by the gas pipe (**A**);
- 3) Once the chain is in position, push the cooker against the wall;
- 4) The height of the screw hole from floor level must not exceed 800 mm (**C**).

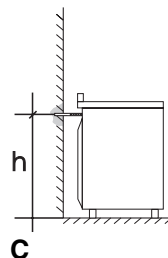
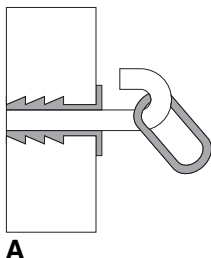



3. ADAPTATION TO DIFFERENT TYPES OF GAS



Before performing any cleaning or maintenance work, switch off the power supply to the appliance.

The cooking hob of the cooker is preset for **G20 natural gas** at a pressure of 20 mbar. In the case of functioning with other types of gas the burner nozzles must be changed and the minimum flame adjusted on the gas taps. Replace the burner nozzles as indicated in the table of the gas to be used.

3.1 Changing nozzles

1. Extract the grids and remove all the caps and flame-spreader crowns;
2. unscrew the burner nozzles with a 7 mm socket wrench;
3. proceed with replacing the burner nozzles in accordance with the table for the gas in question.

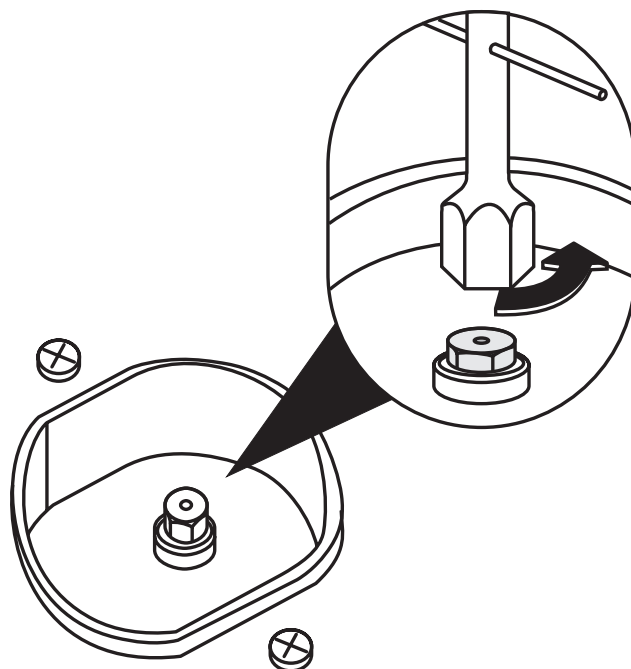



3.2 Burner and nozzle characteristics table

Burner	Rated heating capacity (kW)	LPG – G30/G31 28/37 mbar (drawing ref. X238)				
		Nozzle diameter 1/100 mm	By-pass Mm 1/100	Reduced flowrate (W)	Flowrate g/h G30	Flowrate g/h G31
Auxiliary	1.05	50	30	400	76	75
Semi rapid	1.8	65	33	500	131	129
Rapid	3.0	85	45	800	218	215
Fish Burner	1.9	68	45	800	138	136
Triple crown	4.0	100	65	1600	291	286

Burner	Rated heating capacity (kW)	NATURAL GAS – G20 20 mbar		
		Nozzle diameter 1/100 mm	Drawing Ref.	Reduced flowrate (W)
Auxiliary	1.05	72	(X)	400
Semi rapid	1.8	97	(Z)	500
Rapid	3.0	115	(Y)	800
Fish Burner	1.9	94	(X)	800
Triple crown	4.0	135	(S)	1600

3.3 Arrangement of burners on cooking hob

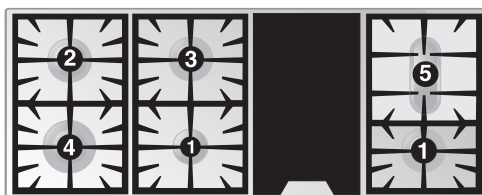

BURNERS

- 1 Auxiliary
- 2 Semi rapid
- 3 Rapid
- 4 Triple crown
- 5 Fish burner



4. FINAL OPERATIONS

After replacing the nozzles, reposition the flame-spreader crowns, the burner caps and the grids.



Following adjustment to a gas other than the preset one, replace the gas adjustment label fixed to the appliance with the one corresponding to the new gas. This label is in the packet together with the nozzles.

4.1 Adjustment of minimum for natural gas

Light the burner and turn it to the minimum position Δ . Extract the gas tap knob and turn the adjustment screw at the side of the tap rod until the correct minimum flame is achieved.

Replace the knob and check burner flame stability: (rapidly turning the knob from maximum to minimum position, the flame should not go out). Repeat the operation on all the gas taps.

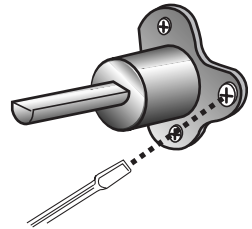

4.2 Regulation of minimum for LPG

For regulating the minimum with LPG, the screw at the side of the tap rod must be turned clockwise all the way.

The bypass diameters for each individual burner are shown in paragraph "3.2 Burner and nozzle characteristics table". When adjustment is complete, re-seal the by-passes using wax or an equivalent material.



4.3 Mounting the rear top upstand

- Position the upstand above the top, taking care to align holes **A** with holes **B**.
- Secure the upstand to the top by tightening screws **C**.

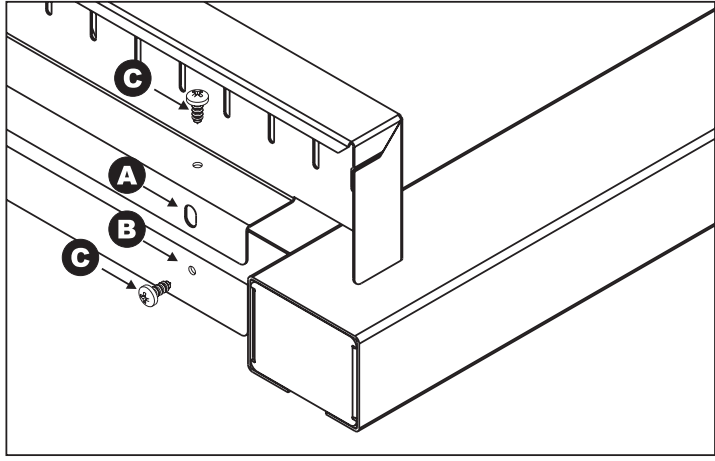





5. DESCRIPTION OF CONTROLS

5.1 Front control panel

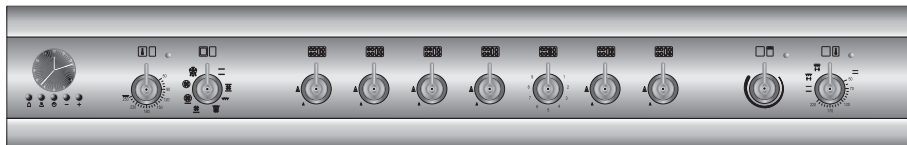
All the cooker controls and commands are on the front panel.



The user has only to press the central key  for 1 - 2 seconds to enable use of the oven on first use or after a power blackout.

DESCRIZIONE DEI SIMBOLI



FRONT LEFT BURNER



BACK LEFT BURNER



FRONT CENTRAL BURNER



BACK CENTRAL BURNER



FRONT RIGHT BURNER



BACK RIGHT BURNER



BARBECUE ELEMENT



MAIN OVEN THERMOSTAT



AUXILIARY OVEN THERMOSTAT



MAIN OVEN FUNCTIONS



AUXILIARY OVEN FUNCTIONS

MAIN OVEN THERMOSTAT KNOB

Selection of cooking temperature is carried out by turning the knob clockwise to the required temperature, between 50° and 250°C.

The tell-tale light comes on to indicate that the oven is warming up. When it goes out it means that the required temperature has been reached. Intermittent going on and off of the light means that the oven temperature is being constantly maintained at the programmed level.

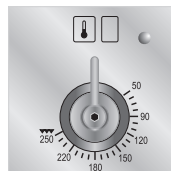

Instructions for the user



FUNCTION SWITCH KNOB

Turn the knob to select from the following functions:

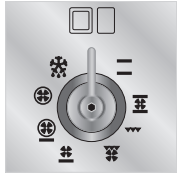

NO FUNCTION SET



GRILL ELEMENT + VENTILATION



UPPER AND LOWER HEATING ELEMENT



LOWER HEATING ELEMENT + VENTILATION



UPPER AND LOWER HEATING ELEMENT + VENTILATION



LOWER HEATING ELEMENT + VENTILATED HEATING ELEMENT



GRILL ELEMENT



VENTILATED HEATING ELEMENT + VENTILATION



DEFROSTING

COOKING HOB BURNER COMMAND KNOB

The flame is lit by pressing the knob and turning it anticlockwise to maximum flame . To adjust the flame turn the knob between maximum () and minimum (). The burner goes out when the knob is returned to the position .

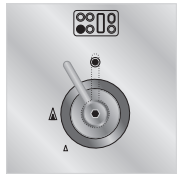

BARBECUE ELEMENT POWER REGULATOR KNOB

This knob allows adjustment of the power of the barbecue griddle on the hob. Set the knob on any position from "1" to "9" to turn on the heating element. The pilot light illuminates to indicate that the element is in operation. To switch off the element, turn the knob to "0".

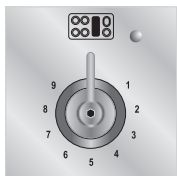



CAUTION: after it has been in operation for some time, the plate will remain hot even after the element has been switched off: keep children at a safe distance.



Instructions for the user

GB-IE

AUXILIARY OVEN VARIABLE GRILL KNOB

Position the auxiliary oven thermostat knob on the symbol  or .

Turn the variable grill knob clockwise to the desired position.

When the signal light comes on the grill is engaged.



AUXILIARY OVEN THERMOSTAT KNOB

Selection of cooking temperature is carried out by turning the knob clockwise to the required temperature, between 50° and 220°C.

The tell-tale light comes on to indicate that the oven is warming up. When it goes out it means that the required temperature has been reached. Intermittent going on and off of the light means that the oven temperature is being constantly maintained at the programmed level.

The oven is switched on by turning the knob clockwise to any one of the following functions except the oven light:



NO FUNCTION SET



UPPER AND LOWER HEATING ELEMENT (between 50° and 220°C)



LOWER HEATING ELEMENT



GRILL ELEMENT (spit)



UPPER HEATING ELEMENT + GRILL ELEMENT



5.2 Electronic Analogue Clock

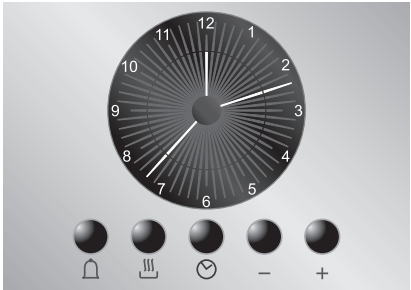

LIST OF FUNCTIONS



MINUTE-MINDER BUTTON



AUTOMATIC SWITCH-OFF TIMING BUTTON



TIME SETTING AND RESET





VALUE DECREASE BUTTON



VALUE INCREASE BUTTON

5.2.1 Setting the time

When the oven is used for the first time, or after a power blackout, the display flashes on and off at regular intervals. Press the  key for 1/2 seconds to stop the display flashing and start setting of the current time.

Press the value modification keys  or  to increase or decrease by one minute for each time a key is pressed.

Press one of the two value modification keys until the current time appears. The clock will start from the time set 6/7 seconds after the last key is pressed.



At the end of each programmed cooking operation, the clock gives 8 beeps, repeated 3/4 times at intervals of about 1 and a half minutes. The beeps can be stopped at any moment by pressing any key.







Instructions for the user

GB-IE

5.2.2 Minute-minder

This function does not stop cooking but just triggers the beeps.

- When the  key is pressed the display illuminates, appearing as shown in figure 1;
- Press the  or  keys within 6/7 seconds to set the minute-minder. Whenever a key is pressed, 1 outside segment, representing 1 cooking minute will light up (figure 2 shows 10 cooking minutes).
- The countdown will start 6/7 seconds after the last key is pressed; at the end of it, you will hear the beeps.
- During cooking with countdown, the current time can be displayed by pressing the  key once; press again to return to the minute-minder display.
- At the end of the countdown, the oven has to be switched off by hand, by turning the thermostat and the function selector to 0.



1









2



5.2.3 Programming

Cooking duration time: the 2nd button  can be used to set the cooking time. Before setting it, turn the thermostat to the cooking temperature of choice and the function selector knob to any setting. To set the cooking time, proceed as follows:

- Press the  key for 1/2 seconds; the pointer will move to position 12 (Fig. 1).
- Use the  and  keys to set the cooking time; whenever the  key is pressed, 1 minute will be added to the cooking time, and every 12 minutes a new inside segment will light up (figure 2 shows a cooking time of 1 hour).
- Once the required time has been set, cooking will start about 6 seconds after the last time the  or  key is pressed.
- Once cooking has started, the display will show the current time, represented by the constantly on segments, and the minutes left until cooking finishes, represented by the flashing segments (every flashing segments indicates 12 minutes of cooking time left).
- When the end of the cooking time is reached, the timer will switch off the oven heating elements, the beeps will start and the numbers on the dial will flash.
- The cooking time can also be reset by deleting the program set; pressing the central key  for 1 or 2 seconds will delete the time set and the oven will have to be switched off by hand.



1



2

Caution: cooking times of more than 6 hours cannot be set.



Instructions for the user

GB-IE

Cooking start: as well as setting a cooking duration time, the user can also set the cooking start time (up to 12 hours after the current time). To set the cooking start/end time, proceed as follows.

- Set the cooking duration time as described in the previous point.
- Within 6/7 seconds after the last time the **-** or **+** keys are pressed, press the **|||** key to set the cooking start time. The display will show the current time with the inside segments indicating the cooking end time illuminated. Use the **-** and **+** keys to set the cooking start time.
- 6/7 seconds after the last time a key is pressed, the display will show the current time and the cooking start and end times, indicated by the illuminated inside segments. The segments on the display will be constantly on until the current time is the same as the cooking start time; as soon as the current time reaches the cooking start time set, all the inside segments will start to flash, indicating that the oven has started cooking.
- When the end of the cooking time is reached, the timer will switch off the oven heating elements, the beeps will start and the numbers on the dial will flash.
- To reset the entire program set, keep the central key  pressed for 1 or 2 seconds: if cooking has already started the oven will have to be switched off by hand.
- The image on the right shows an example of programming: the current time is 7.06 and cooking is programmed to start at 8 o'clock and finish at 9.
- At 8 o'clock, the inside segments between 8 and 9 will start to flash and the hour pointer will remain still.



Caution: for the oven to start cooking after the programming procedure just described, the thermostat and function selector must be properly set on the temperature and function required.

5.2.4 "DEMO" Function

Models with analogue/digital programmer feature a "DEMO" function which deactivates the heating elements while leaving the other functions unchanged. To activate it, simply press the , **-** and **+** keys for 3/4 seconds. A confirmation beep will inform the user that the function is active. To deactivate it, simply repeat the same procedure.



6. USE OF THE COOKING HOB

6.1 Lighting of the cooking hob burners



Before lighting the cooking hob burners check that the flame cap crowns are properly positioned with their appropriate burner caps: niche **A** must be centred with pin **B**.
Grid **C** should be used with Chinese woks.

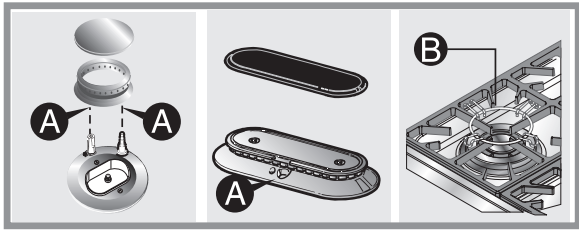

Each knob corresponds to the burner indicated. The appliance is equipped with an electronic lighting device. Just press and turn the knob anticlockwise to the maximum flame symbol \blacktriangle until the burner lights. Keep the knob pressed for about 2 seconds to let the thermocouple heat up. If the burner turns off when the knob is released, it means that the thermocouple isn't hot enough. Repeat ignition and keep the knob pressed longer.

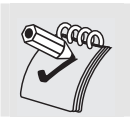

If the burners turn off accidentally, a safety device will trip after about 20 seconds to cut off gas flow (even with the gas tap open).



6.2 Practical advice for using the cooking hob burners

For better use of the burners and lower gas consumption, use covered containers that are proportional in size to the burner to prevent the flame from licking the sides (see paragraph "6.3 Diameter of containers"). When water reaches the boiling point, lower the flame so that it doesn't overflow. To avoid burns or damage to the hob, all recipients or griddle plates must be placed within the perimeter of the cooking hob. All containers have to have a flat and smooth bottom. When using fats or oils, be extremely careful that they don't overheat and catch fire. If the flame accidentally goes out, turn off the control knob and wait at least 1 minute before trying to re-light the burner.



Instructions for the user

GB-IE

6.3 Diameter of containers

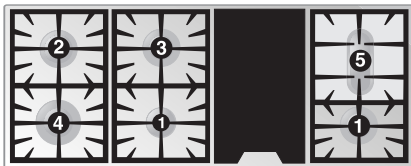

BURNERS

Ø min. e max.
(in cm)

- 1 Auxiliary
- 2 Semi rapid
- 3 Rapid
- 4 Ultra rapid
- 5 Fish Burner

12-14
16-20
18-24
20-24
Special oval-shaped vessels

6.4 Using the griddle plate



The griddle plate is coated with a thin film of non-stick material (Teflon). This film is very delicate and could be damaged or scratched by any metal cooking tool. **Use only wooden or heat resistant plastic tools.**



7. USE OF THE OVENS

7.1 Warnings and general advice

Before using the oven for the first time, pre-heat it to maximum temperature (250-220°C) long enough to burn any manufacturing oily residues which could give the food a bad taste.



During cooking, do not cover the bottom of the oven with aluminium or tin foil and do not place pans or oven trays on it as this may damage the enamel coating. If you wish to use greaseproof paper, place it so that it will not interfere with the hot air circulation inside the oven.



To prevent any steam in the oven creating problems, open the door in two stages: half open (5 cm approx.) for 4-5 seconds and then fully open. To access food, always leave the door open as short a time as possible to prevent the temperature in the oven from falling and ruining the food.

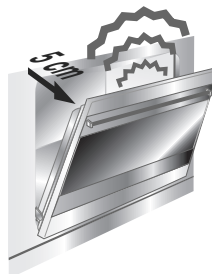



7.2 Oven Light

It comes on when the function switch knob is turned to any position.

7.3 Cooling fan

The appliance is equipped with a cooling system, which comes into operation as soon as a cooking function is selected. This is also the case for cooking with the minute minder.

Fans cause a steady outflow of air from the rear top skirtboard on the rear of the cooking hob, which may continue for a brief period of time even after the oven has been turned off.

This ventilation system ensures that the temperatures on the outside of the appliance meet the standards required by the current regulations.

7.4 Storage compartment

A storage compartment, accessible by pulling on the top edge of the door, is located beneath the ovens.

Never store inflammable materials such as rags, paper or the like. The compartment is intended only for holding the metal accessories of the range.

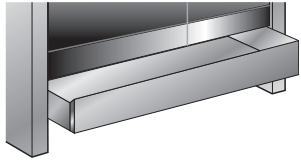

Never open the storage compartment when the oven is on and still hot. The temperature inside may be very high.



8. ACCESSORIES

The oven features **4 support** positions for plates and racks of different height.



Oven grill: for cooking food on plates, small cakes, roasts or food requiring light grilling.



Plate grill: for placing above plate for cooking foods that might drip.



Oven plate: useful for catching fat from foods on the grill above.



Pastry plate: for baking cakes, pizza and oven desserts.



Roasting spit: useful for cooking chicken, sausages and anything else requiring uniform cooking over the whole surface. Only for **auxiliary oven**.

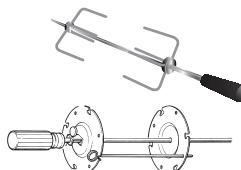

Main oven rotisserie frame: to be fitted into the holes provided in the oven dish.



Spit Frame: to be inserted in the guides of the **auxiliary oven** before using the spit.

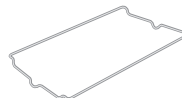

Accessories on Request

You can order the lower base and self-cleaning oven panels through Authorised Assistance Centres.



Two optional accessories are also available from Authorised Service Centres:

Griddle plate on gas burner: *this optional plate is for installation on the hob instead of the right-hand pan stand (fish burner). Take care that the feet of the griddle plate are resting firmly on the base of the hob to prevent the risk of tipping.*

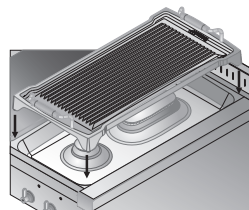

Barbecue grille: *this open grille is for installation on the barbecue element instead of the aluminium plate.*

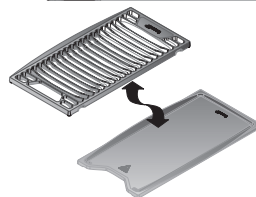



Instructions for the user

GB-IE

9. COOKING HINTS



In fan-assisted mode preheating should be carried out at 30/40°C above the cooking temperature. This considerably shortens cooking times and reduces power consumption, as well as giving better cooking results.



Keep the oven door closed during cooking

9.1 Traditional cooking (main and auxiliary ovens)



FUNCTION SWITCH



THERMOSTAT SELECTOR SWITCH FROM 50° TO 250°C



THERMOSTAT SELECTOR SWITCH FROM 50° TO 220°C



This traditional cooking method, in which heat comes from above and below, is suitable for cooking food on a single level. You have to pre-heat the oven until the set temperature is reached. Place the food in the oven only after the thermostat indicator light has turned off. very fatty meats may be put in when the oven is still cold. Put frozen meat in immediately, without waiting for it to thaw. The only precaution you need to take is to set the temperature about 20°C lower and cooking time about 1/4 longer than you would for fresh meat.



Use high-rim pans to prevent fat splashing and dirtying the sides of the oven.



Instructions for the user



9.2 Hot-air cooking (main oven)



FUNCTION SWITCH



THERMOSTAT SELECTOR SWITCH FROM 50° TO 250°C



This system is suitable for cooking on several levels, including different types of food (fish, meat etc.), without the tastes and smells mingling. Air circulation in the oven ensures a uniform distribution of heat. Pre-heating is not necessary.

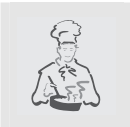

Multiple cooking is possible as long as the cooking temperature of the different foods is the same.

9.3 Grill cooking (main oven)



FUNCTION SWITCH



THERMOSTAT SWITCH AT MAXIMUM



Permits rapid browning of foods. You are advised to place the pan in the highest guide. For short-term cooking of small quantities, place the grid in the third guide from the bottom. For long-term cooking and grills, put the grid in the lowest guide in accordance with the size of the pieces.

Keep the oven door closed during cooking.



Instructions for the user



9.4 Hot-air grilling (main oven)



FUNCTION SWITCH



THERMOSTAT SWITCH FROM 50° TO 200°C



Ensures uniform heat distribution with greater heat penetration into the food. Food will be lightly browned on the outside and remain soft inside. **Keep the oven door closed during cooking. Heating up time must not exceed 60 minutes.**

9.5 Variable grill cooking (auxiliary oven)



THERMOSTAT SWITCH IN POSITION

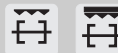

VARIABLE GRILL CHOICE BETWEEN MIN. AND MAX.



This function permits varying the power of the grill according to the quantity of food to be cooked.

Position the auxiliary oven thermostat knob on the symbol  or .

Turn the variable grill knob clockwise to the desired position.

When the signal light comes on the grill is engaged.

Keep the oven door closed during cooking.



9.6 Delicate cooking (auxiliary oven)



FUNCTION SWITCH



THERMOSTAT SWITCH AT MAXIMUM



Ideal for pastries and cakes with wet covering and little sugar and damp desserts in moulds. Excellent results can also be achieved in completing cooking at the bottom and with dishes requiring heat in the lower area in particular. The plate is best inserted at bottom level.

9.7 Defrosting (main oven)



FUNCTION SWITCH



THERMOSTAT SWITCH IN POSITION 0



The flow of air produced by the fan ensures quicker defrosting. The air circulating inside the oven is at room temperature.



The advantage of defrosting at room temperature is that it does not alter the taste and appearance of the food.



Instructions for the user

GB-IE

9.8 Spit cooking (main oven)



FUNCTION SWITCH



THERMOSTAT SWITCH FROM 50° TO 200°C



Prepare the spit with the food, blocking fork screws **A**. Insert frame **B** into the third guide from the bottom. Remove handle **D** and position the spit shaft so that pulley **E** is guided on the link of frame **B** in the right side. Insert the drip tray into the oven as far as it will go until the tip of the rod is in line with the hole **C**. Now rock the frames **B** to insert the tip of the rod into the drive connection **C** of the rotisserie motor on the side of the oven. Pour a bit of water into the pan to avoid smoke from the dripping. **Keep the oven door closed during cooking.**



It is normal for the thermostat light to go on and off intermittently during cooking. This indicates the temperature inside the oven is regular.

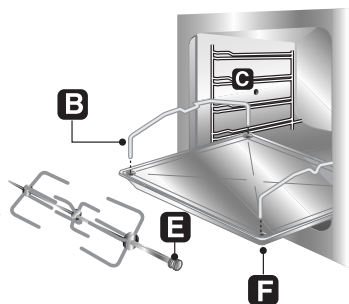
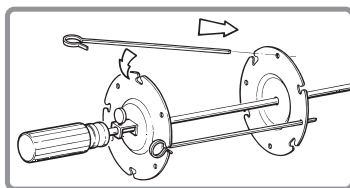





CAUTION: the frames **B** must be fitted as shown in the diagram





9.9 Spit cooking (auxiliary oven)

			
FUNCTION SWITCH			
VARIABLE GRILL CHOICE BETWEEN MIN. AND 3/4 MAX			



Use it for small size pieces.

Prepare the spit with the food, blocking fork screws **A**. Insert frame **B** into the third guide from the bottom. Remove handle **D** and position the spit shaft so that pulley **E** is guided on the link of frame **B**. Fully insert frame **B** until the point of the spit shaft enters the spit-turning motor housing **C** on the rear wall of the oven. Position pan **F** on the lowest guide and pour a little water in to avoid smoke forming.
Keep the oven door closed during cooking.



It is normal for the thermostat light to go on and off intermittently during cooking. This indicates the temperature inside the oven is regular.

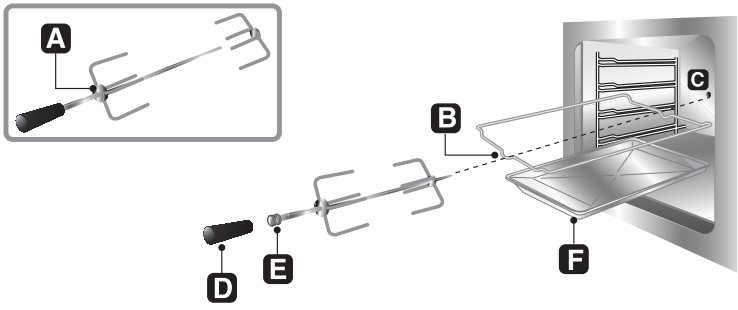



Instructions for the user



9.10 Recommended cooking table

Cooking times, especially meat, vary according to the thickness and quality of the food and to consumer taste.

TRADITIONAL COOKING



	LEVEL FROM BELOW	TEMPERATURE (°C)	TIME IN MINUTES (*)
FIRST COURSES			
LASAGNE	2 - 3	210 - 230	30
OVEN-BAKED PASTA	2 - 3	210 - 230	40
MEAT			
ROAST VEAL	2	170 - 200	30 - 40 / KG.
ROAST BEEF	2	210 - 240	30 - 40 / KG.
ROAST PORK	2	170 - 200	30 - 40 / KG.
CHICKEN	2	170 - 200	45 - 60
DUCK	2	170 - 200	45 - 60
GOOSE - TURKEY	2	140 - 170	45 - 60
RABBIT	2	170 - 200	50 - 60
LEG OF LAMB	1	170 - 200	15 / KG.
ROAST FISH	1 - 2	170 - 200	ACCORDING TO DIMENSIONS
PIZZA	1 - 2	210 - 240	40 - 45
DESSERTS			
MERINGUE	1 - 2	50 - 70	60 - 90
SHORT PASTRY	1 - 2	170 - 200	15 - 20
CIAMBELLA	1 - 2	165	35 - 45
SAVOYARDS	1 - 2	150	30 - 50
BRIOCHEs	1 - 2	170 - 200	40 - 45
FRUIT CAKE	1 - 2	170 - 200	20 - 30

(*) = WITH PREHEATED OVEN

GRILLING



	LEVEL FROM BELOW	TIME IN MINUTES	
		FIRST SURFACE	SECOND SURFACE
PORK CHOPS	4	7 - 9	5 - 7
FILLET OF PORK	3	9 - 11	5 - 9
FILLET OF BEEF	3	9 - 11	9 - 11
LIVER	4	2 - 3	2 - 3
VEAL ESCALOPEs	4	7 - 9	5 - 7
HALF CHICKEN	3	9 - 14	9 - 11
SAUSAGES	4	7 - 9	5 - 6
MEAT-BALLS	4	7 - 9	5 - 6
FISH FILLETS	4	5 - 6	3 - 4
TOAST	4	2 - 4	2 - 3



HOT-AIR COOKING



	LEVEL FROM BELOW	TEMPERATURE (°C)	TIME IN MINUTES
FIRST COURSES			
LASAGNE	2	190 - 210	20 - 25
OVEN-BAKED PASTA	2	190 - 210	25 - 30
CREOLE RICE	2	190 - 220	20 - 25
MEAT			
ROAST VEAL	2	150 - 170	65 - 90
ROAST PORK	2	150 - 160	70 - 100
ROASTED BEEF	2	160 - 170	65 - 90
FILLET OF BEEF	2	160 - 180	35 - 45
ROAST LAMB	2	130 - 150	100 - 130
ROAST BEEF	2	170 - 180	40 - 45
ROAST CHICKEN	2	170	70 - 90
ROAST DUCK	2	160 - 170	100 - 160
ROAST TURKEY	2	150 - 160	160 - 240
ROAST RABBIT	2	150 - 160	80 - 100
ROAST HARE	2	160 - 170	30 - 50
ROAST PIGEON	2	140 - 170	15 - 25
FISH	2 - 3	150 - 170	ACCORDING TO DIMENSIONS
PIZZA	2 - 3	210 - 240	30 - 50
DESSERTS (PASTRIES)			
CIAMBELLA	2 - 3	150 - 170	35 - 45
FRUIT CAKE	2 - 3	170 - 190	40 - 50
SPONGE-CAKE	2 - 3	190 - 220	25 - 35
BRIOCHES	2 - 3	160 - 170	40 - 60
STRUDEL	1 - 2	150	25 - 35
SAVOYARD PUDDING	2 - 3	160 - 170	30 - 40
BREAD	2 - 3	190 - 210	40
TOAST	1 - 2	220 - 240	7



When cooking with the barbecue griddle, it should be left to heat up for about 15 minutes.



Instructions for the user

GB-IE

10. CLEANING AND MAINTENANCE



Do not use a steam jet for cleaning the inside of the oven.

10.1 Cleaning stainless steel



To keep stainless steel in good condition it should be cleaned regularly after use. Let it cool first.

10.1.1 Ordinary Daily Cleaning

To clean and preserve the stainless steel surfaces, always use **only** specific products that do not contain abrasives or chlorine-based acids.

How to use: pour the product on a damp cloth and wipe the surface, rinse thoroughly and dry with a soft cloth or deerskin.

10.1.2 Food stains or residues

Do not use metallic sponges or sharp scrapers: they will damage the surface.

Use normal non-abrasive products for steel, and a wooden or plastic tool if necessary.

Rinse thoroughly and dry with a soft cloth or deerskin.

Do not allow residues of sugary foods (such as jam) to set inside the oven. If left to set for too long, they might damage the enamel lining of the oven.





10.2 Cleaning of cooking hob components

Before performing any operations requiring access to powered parts, switch off the power supply to the machine.



10.2.1 Barbecue griddle

Extract the griddle from its seat (after leaving it to cool) by lifting it from the front as shown in the diagram and taking care not to spill the residues which have collected in the grooves at the sides. Clean it with an ordinary detergent and a non-abrasive sponge.

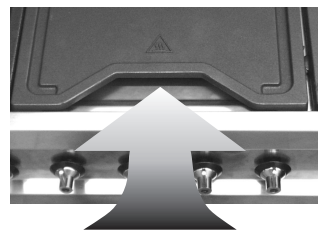

10.2.2 Barbecue drip tray

To remove the drip tray under the barbecue element:

1. Remove the griddle as described in point 10.2.1;
2. Raise the heating element and fix it in place by sliding the retainer to the right (as shown in the adjacent diagram);
3. Remove the drip tray using the two handles and clean using specific detergents for stainless steel and a non-abrasive sponge.

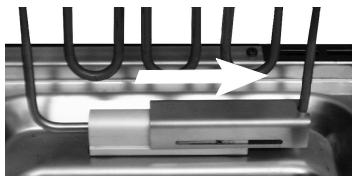

10.2.3 Grids

Remove the right-hand pan stands (griddle + fish burner) as shown in the diagram. There is no special order for removal of the left-hand pan stands. Clean the pan stands in warm water and non-abrasive detergent, taking care to remove all deposits. Replace, fitting first the outside pan stand then the griddle.

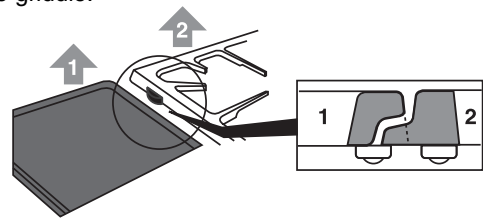



Instructions for the user

GB-IE

10.2.4 Burner caps, flame cap crowns and burners

The burner caps, flame cap crowns and burners are extractable to facilitate cleaning. Wash them with hot water and non-abrasive detergent, taking care to remove incrustation, and leave them to **dry completely**. Reassemble the burner caps on their crowns, ensuring that niches **A** are centred with burner pins **B**.

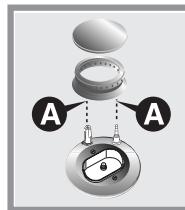

10.2.5 Ignition plugs and thermocouples

To work well, the ignition plugs and thermocouples must always be very clean. Check them frequently and clean them with a wet rag if necessary. Any dry residue should be removed with a toothpick or a needle.



10.3 Cleaning of ovens (without self-cleaning panels)



To keep an oven in good condition it must be cleaned regularly. Let it cool first. Take out all the removable parts.

Remove the shelf runners by lifting them at the front and extracting them from their rear holes.

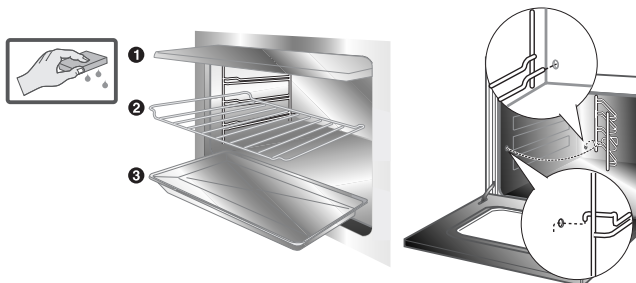

- Clean the oven grill and side guides with hot water and non-abrasive detergent. Rinse and dry.



10.3.1 Self-cleaning liners

The main oven is equipped with continuous self-cleaning enamelled liners.

These liners make the oven easier to clean and ensure its efficiency over time.

10.3.2 Using the self-cleaning liners

Periodically, to prevent food residues and unpleasant smells from accumulating inside the oven, the appliance should be operated empty at temperatures of not less than 200°C for a time varying from 30 to 60 minutes, in order to allow the self-cleaning liners to oxidise the residues present; when the oven has cooled, these will then be removed with a damp sponge

10.3.3 Looking after the self-cleaning liners

The liners should not be cleaned with abrasive creams or ordinary detergents. Use a damp sponge only, so as not to damage the special characteristics of the enamel which coats the liners.

10.3.4 Assembling the self-cleaning liners

1. Remove all accessories from the oven;
2. Remove the side grilles (fig.1);
3. Extract the side liners "F" and "G"(fig. 2);
4. Remove the back panel "A" after undoing the threaded ring-nut "C" (fig. 2).
5. Reassemble the panels, restoring them to their original position.

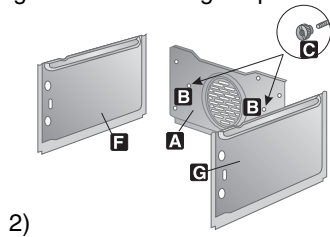
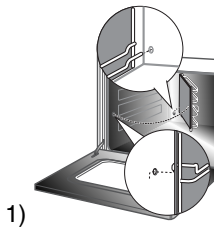

10.4 Door glass

These should always be kept very clean. Use absorbent kitchen paper or, in case of hard to remove dirt, wash with a wet sponge and ordinary detergent.



Instructions for the user

GB-IE

11. EXTRAORDINARY MAINTENANCE

Ovens periodically require small maintenance interventions or replacement of parts subject to wear and tear such as gaskets, electric bulbs etc. Specific instructions for each intervention of this type appear below.



Before performing any operations requiring access to powered parts, switch off the power supply to the machine.

11.1 Replacement of light bulbs

Remove cover **A** by twisting anticlockwise, replace bulb **B** with another similar bulb. Refit the cover **A**.

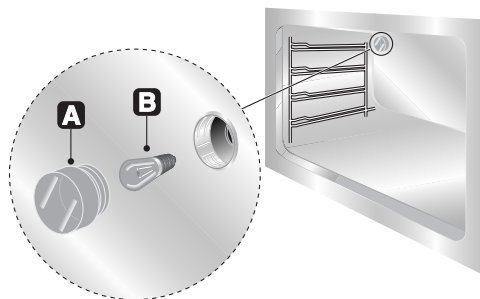

Only use oven bulbs (T 300°C).



11.2 Removing the door

Open the door completely and fit the pins (supplied) into the holes from the inside. Close the door to an angle of about 45°, lift it and remove it from its seat. To replace, fit the hinges into the grooves provided, then lower the door until it comes to rest and extract the pins. If the pins are lost, two screwdrivers can also be used.

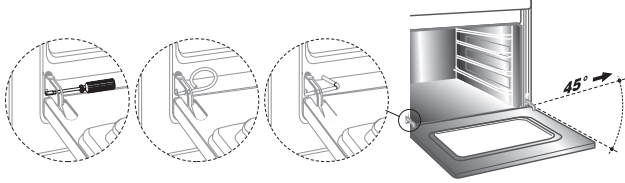

11.3 Oven door gaskets

The door gaskets can be dismantled for thorough cleaning of the ovens. Before removing the gaskets the oven doors must be removed as previously described. With the doors removed, raise the tabs at the corners as shown in the figure.

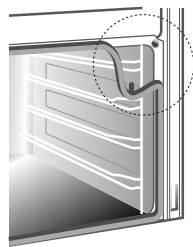

11.4 Lubrication of gas taps

With time it may happen that the gas taps get blocked and hard to turn. Clean them inside and re-grease them. **This operation must be done by a specialised technician.**

