

1.	INSTRUCTIONS FOR PROPER USE	19
2.	SAFETY INSTRUCTIONS	20
3.	KNOW YOUR HOB	21
4.	BEFORE FIRST USE	21
5.	COOKING ZONES	22
6.	DESCRIPTION OF CONTROL ON THE FRONT CONTROL PANEL	23
7.	USE OF THE COOKING HOB	24
8.	CLEANING AND MAINTENANCE	28
9.	SOMETHING WRONG?	28
10.	INSTALLATION	29



INSTRUCTIONS FOR THE USER: these contain user advice, description of the commands and the correct procedures for cleaning and maintenance of the appliance.



THE SYMBOLS SHOWN IN THIS MANUAL MAY DIFFER FROM THOSE ON THE PRODUCT.



INSTRUCTIONS FOR THE INSTALLER: these are intended for the **qualified technician** who must install the appliance, set it functioning and carry out an inspection test.

1. INSTRUCTIONS FOR PROPER USE



ELECTRICAL CONNECTION: PLEASE REFER TO INSTALLATION INSTRUCTIONS FOR THE GAS & ELECTRICAL SAFETY REGULATIONS AND THE VENTILATION REQUIREMENTS.

IN YOUR OWN INTEREST, AND THAT OF SAFETY, IT IS THE LAW THAT ALL GAS AND ELECTRICAL APPLIANCES BE INSTALLED AND SERVICED BY COMPETENT PERSONS, WHO WILL COMPLY WITH THE RELEVANT STANDARDS AND REGULATIONS.

SMEG REGISTERED INSTALLERS UNDERTAKE TO WORK TO SATISFACTORY STANDARDS. DISCONNECTION OF GAS AND ELECTRIC APPLIANCES SHOULD ALWAYS BE CARRIED OUT BY COMPETENT PERSONS



THIS MANUAL IS AN INTEGRAL PART OF THE APPLIANCE AND THEREFORE MUST BE KEPT IN ITS ENTIRETY AND IN AN ACCESSIBLE PLACE FOR THE WHOLE WORKING LIFE OF THE HOB. WE ADVISE READING THIS MANUAL AND ALL THE INSTRUCTIONS THEREIN BEFORE USING THE HOB. INSTALLATION MUST BE CARRIED OUT BY QUALIFIED PERSONNEL IN ACCORDANCE WITH THE REGULATIONS IN FORCE. THIS APPLIANCE IS INTENDED FOR DOMESTIC USES AND CONFORMS TO CURRENT **REGULATIONS IN FORCE**. THE APPLIANCE HAS BEEN BUILT TO CARRY OUT THE FOLLOWING FUNCTIONS: **COOKING AND HEATING-UP OF FOOD**. ALL OTHER USES ARE CONSIDERED IMPROPER.

THE MANUFACTURER DECLINES ALL RESPONSIBILITY FOR IMPROPER USE.

NEVER USE THIS APPLIANCE FOR HEATING ROOMS.



DO NOT LEAVE THE PACKING IN THE HOME ENVIRONMENT. SEPARATE THE VARIOUS WASTE MATERIALS AND TAKE THEM TO THE NEAREST SPECIAL GARBAGE COLLECTION CENTRE.



THIS APPLIANCE IS MARKED ACCORDING TO THE EUROPEAN DIRECTIVE 2002/96/EC ON WASTE ELECTRICAL AND ELECTRONIC EQUIPMENT (WEEE).

THIS GUIDELINE IS THE FRAME OF A EUROPEAN-WIDE VALIDITY OF RETURN AND RECYCLING ON WASTE ELECTRICAL AND ELECTRONIC EQUIPMENT.



THE IDENTIFICATION PLATE, WITH TECHNICAL DATA, SERIAL NUMBER AND MARKING IS CLEARLY VISIBLE UNDER THE CASING.

THE PLATE ON THE CASING MUST NOT BE REMOVED.



TAKE CARE NOT TO SPILL SUGAR OR SWEET MIXTURES ON TO THE HOB WHEN HOT. NEVER PLACE MATERIALS OR SUBSTANCES WHICH MAY MELT (PLASTIC OR ALUMINIUM FOIL) ON THE HOB. IN THE EVENT, PROMPTLY SWITCH OFF AND REMOVE THE MOLTEN MATERIAL WITH THE SCRAPER PROVIDED WHILE THE COOKING ZONE IS STILL WARM TO PREVENT IT FROM BEING DAMAGED. **FAILURE TO INSTANTLY CLEAN THE CERAMIC HOB COULD LEAD TO ENCRUSTATIONS WHICH ARE IMPOSSIBLE TO REMOVE ONCE THE HOB HAS COOLED DOWN.**

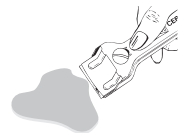

The manufacturer declines all responsibility for damage to persons or things caused by non-observance of the above prescriptions or by interference with any part of the appliance or by the use of non-original spares.

2. SAFETY INSTRUCTIONS



INSTRUCTIONS FOR THE INSTALLER: THESE ARE INTENDED FOR THE QUALIFIED TECHNICIAN WHO MUST INSTALL THE APPLIANCE, SET IT FUNCTIONING AND CARRY OUT AN INSPECTION TEST.



IT IS OBLIGATORY FOR THE ELECTRICAL SYSTEM TO BE GROUNDED ACCORDING TO THE METHODS REQUIRED BY SAFETY RULES.



WHEN LINKING UP TO MAINS BY PLUG AND SOCKET, MAKE SURE THAT BOTH ARE COMPATIBLE AND CONNECT BY MEANS OF A POWER CABLE COMPLYING WITH APPLICABLE REGULATIONS.

THE SOCKET MUST BE ACCESSIBLE AFTER THE APPLIANCE HAS BEEN BUILT IN.

NEVER UNPLUG BY PULLING ON THE CABLE.



ALWAYS CHECK THAT THE CONTROLS ARE IN THE POSITION 0 (OFF) WHEN YOU FINISH USING THE HOB.



DURING USE THE APPLIANCE BECOMES VERY HOT. TAKE CARE NOT TO TOUCH THE SURFACE OF THE HOB.



THE APPLIANCE IS INTENDED FOR USE BY ADULTS. KEEP CHILDREN AT A SAFE DISTANCE AND NEVER ALLOW THEM TO PLAY WITH IT.



THE APPLIANCE BECOMES VERY HOT DURING USE. SUITABLE HEAT-PROOF GLOVES SHOULD BE WORN FOR ALL OPERATIONS.



BEFORE THE APPLIANCE IS PUT INTO OPERATION, ALL THE LABELS AND PROTECTIVE FILMS APPLIED INSIDE OR OUTSIDE MUST BE REMOVED.



IMMEDIATELY AFTER INSTALLATION CARRY OUT A BRIEF INSPECTION TEST OF THE APPLIANCE, FOLLOWING THE INSTRUCTIONS BELOW. SHOULD THE APPLIANCE NOT FUNCTION, DISCONNECT IT FROM THE POWER SUPPLY AND CALL THE NEAREST TECHNICAL ASSISTANCE CENTRE.



NEVER ATTEMPT TO REPAIR THE APPLIANCE. ALL REPAIRS MUST BE CARRIED OUT BY AN AUTHORISED ENGINEER OR AT AN AUTHORISED SERVICE CENTRE.



Important.

Beware of children in the vicinity as the warning lights indicating residual heat are out of sight to them. In fact, even after having been turned off, the cooking zone remains hot for a certain period of time.

Make sure that children never touch the hob.





3. KNOW YOUR HOB

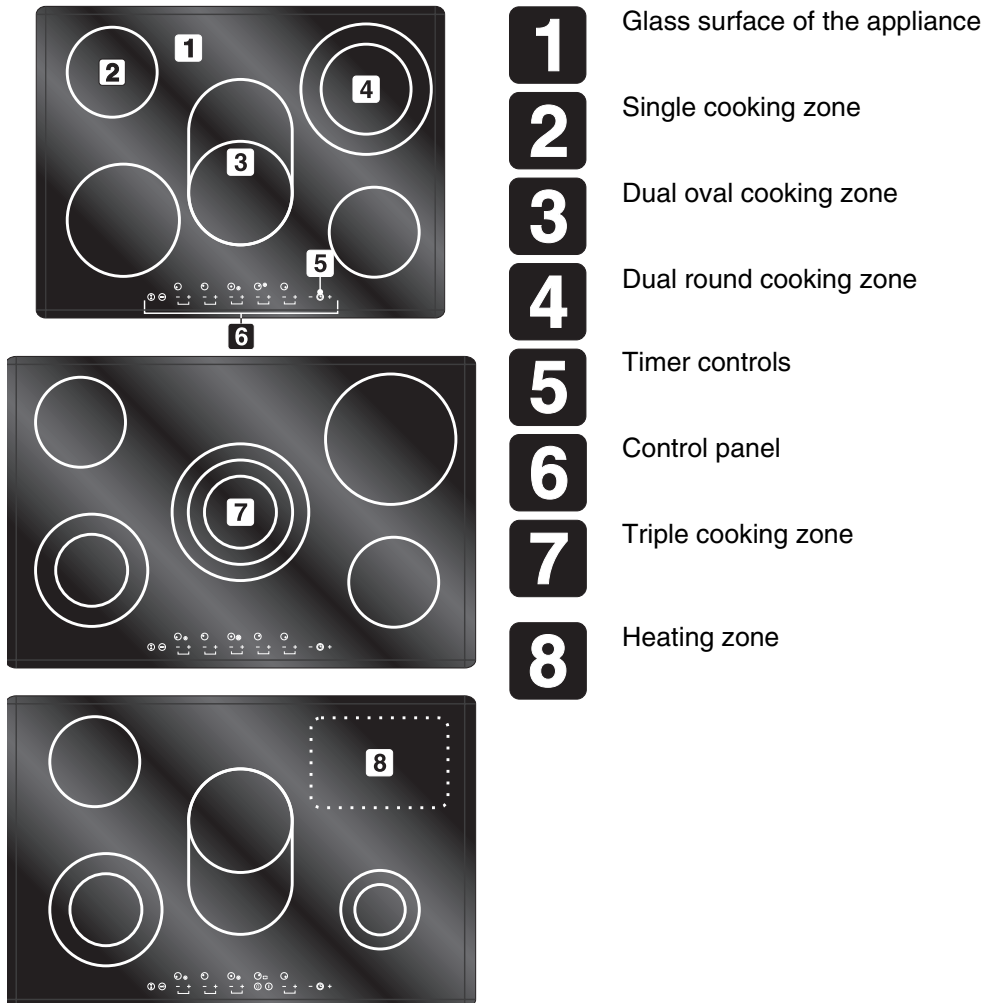

NOT ALL COMPONENTS DESCRIBED ARE PRESENT ON ALL MODELS

4. BEFORE FIRST USE

Do not leave the packing in the home environment. Separate the various waste materials and take them to the nearest special garbage collection centre.

Before cooking for the first time the hob has to be cleaned.

Following this, put a saucepan of water on the front hotplates and turn them full on for at least 30 minutes. After 30 minutes turn off the front hotplates and turn the rear hotplates and the central hotplate, if present, full on. This treatment is necessary in order to get rid of the "new smell" and to evaporate the humidity that may have collected during the manufacturing process. That is, it must be done so that the electronic circuits and the control buttons work properly.

If the controls do not work properly after 30 minutes, it means that not all the humidity has evaporated: leave the hotplates on until all the humidity has evaporated and then turn off the hob.

Remove all the removable labels and any protective sheeting.

To switch on the hob, follow the instructions provided in point "7".





5. COOKING ZONES

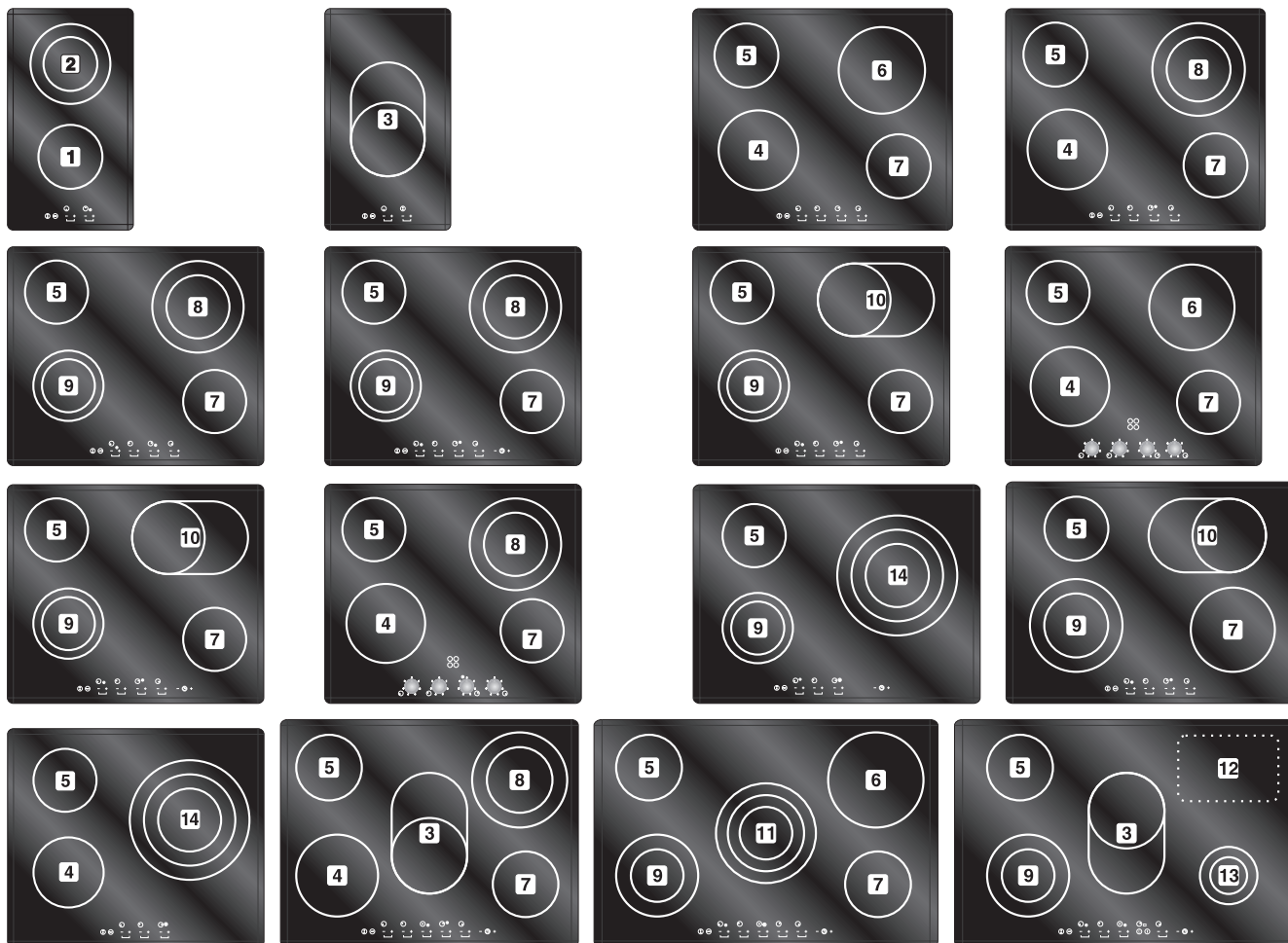

The appliance features 4/5 cooking zones of different diameter and power. Their position is clearly indicated by circles and the heat given off is defined by the markings on the glass surface. The 5 cooking zones are of the HIGH-LIGHT type and come on after a few seconds of being activated. Heating intensity can be adjusted by means of the knobs located on the front panel from a minimum setting of 1 to a maximum setting of 6/9 (Depending on models).



















The cooking zones marked by two concentric circles () feature double heating either within the inner circle or both circles.

- | | | | |
|----------|--------------------------------------|-----------|--|
| 1 | FRONT CENTRAL SINGLE COOKING ZONE | 8 | REAR RIGHT-HAND DUAL COOKING ZONE |
| 2 | REAR CENTRAL DUAL COOKING ZONE | 9 | FRONT LEFT-HAND COOKING ZONE |
| 3 | CENTRAL OVAL DUAL COOKING ZONE | 10 | REAR RIGHT-HAND DUAL OVAL COOKING ZONE |
| 4 | FRONT LEFT-HAND SINGLE COOKING ZONE | 11 | CENTRAL TRIPLE COOKING ZONE |
| 5 | REAR LEFT-HAND SINGLE COOKING ZONE | 12 | HEATING ZONE |
| 6 | REAR RIGHT-HAND SINGLE COOKING ZONE | 13 | FRONT RIGHT-HAND DUAL COOKING ZONE |
| 7 | FRONT RIGHT-HAND SINGLE COOKING ZONE | 14 | RIGHT-HAND TRIPLE COOKING ZONE |



6. DESCRIPTION OF CONTROL ON THE FRONT CONTROL PANEL

All the hob controls are grouped together on the front panel. The table below provides a description of the symbols used.

	HOB IGNITION		OVAL COOKING ZONE
	CONTROLS ON-OFF		REAR RIGHT-HAND COOKING ZONE
	VALUE INCREASE BUTTON		FRONT RIGHT-HAND COOKING ZONE
	VALUE DECREASE BUTTON		FRONT CENTRAL COOKING ZONE
	TIMER SETTING BUTTON		FRONT LEFT-HAND COOKING ZONE
	DUAL COOKING ZONE		REAR LEFT-HAND COOKING ZONE
	TRIPLE COOKING ZONE		REAR CENTRAL COOKING ZONE
	HEATING ZONE (MOD. SE2958TC)		CENTRAL COOKING ZONE
	SWITCHING ON THE HEATING ZONE (MOD. SE2958TC)		
	SWITCHING OFF THE HEATING ZONE (MOD. SE2958TC)		



7. USE OF THE COOKING HOB

7.1 Hobs with knobs

7.1.1 Single cooking zones

Each knob shows the cooking zone it is for.

For example, the symbol  identifies the knob that controls the rear right-hand cooking zone.

To heat, turn the knob to the desired position (1 to 6). Adjustment is continuous so that the appliance also operates at any intermediate value.

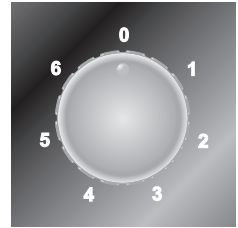
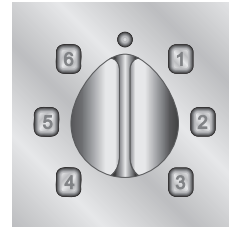

7.1.2 Dual cooking zones

Each knob shows the cooking zone it is for.

For example, the symbol  identifies the knob that controls the rear right-hand cooking zone.

To heat the inner cooking zone, turn the knob to the desired position (1 to 6).

To heat both the inner and outer cooking zones, turn the knob to  and then release. The knob will thus return to 9. To adjust heating intensity, rotate the knob anticlockwise to the desired position. To return to heating of the inner cooking zone only, set the knob back to 0 and then turn to the desired position (1 to 6).

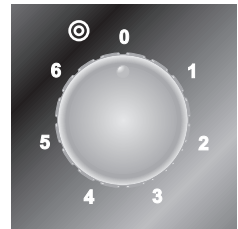

7.1.3 Description of symbols



REAR LEFT



REAR RIGHT



FRONT LEFT



FRONT RIGHT

7.1.4 Residual heat

The 4 warning lights located between the cooking zones come on when the temperature of one or more of the zones exceeds 60°C.

The lights go off upon temperature dropping to below approximately 60°C.



7.1.5 Switching off

To turn off, return the knob to 0.



Instructions for the user



7.2 Hobs with touch-control buttons



When an icon is pressed the unit beeps to confirm.

To operate the panel of the hobs equipped with touch-controls, lightly press the icons printed on its surface.



On first connection to the electrical mains, an operating check will be carried out automatically and all the indicator lights will come on for a few seconds.

7.2.1 Switching on the hob

When not in use, all hob components will be switched off. Hold down for 2 seconds to switch the hob on; a led will turn on above the symbol to confirm that the hob is lit. If no functions are used within 30 seconds of switching the hob on, it will automatically turn itself off.

7.2.2 Single cooking zones



The relevant hotplate is indicated next to each control zone. For example, the symbol identifies the knob which controls the rear right-hand cooking zone.

Having switched on the hob as described in “7.2.1 Switching on the hob”, press the and keys to activate the hotplate (with the display indicating 0) and adjust the power to the desired operating setting.

The operating power levels are 1 (lowest) to 9 (highest).

The power must be set within 5 seconds of activating the hotplate as otherwise it will deactivate automatically.

To activate the hotplate and adjust its power level, press and as follows:

1. Press (0 appears on the display to indicate that the hotplate has been activated);
2. Press again (9 appears on the display to indicate that the hotplate is active at the maximum power setting).
3. Press or to increase or reduce the power to the desired level (1...9).

7.2.3 Dual cooking zones



To activate heating of the dual cooking zone, once power 9 is reached by following the instructions provided in paragraph “7.2.2 Single cooking zones”, press the again. Now the maximum power of the cooking zone is activated, and is shown by the LED light turning on next to the number indicating the operating power. Press on the symbols and to adjust the power of the dual cooking zone to the desired value.

7.2.4 Triple cooking zones



To activate heating of the triple cooking zone, once power 9 of the dual cooking zone is reached by following the instructions provided in paragraph “7.2.3 Dual cooking zones”, press the again. Now the maximum power of the triple cooking zone is activated, and the LED indicating the operating power remains fix. Press on the symbols and to adjust the power of the triple cooking zone to the desired value.

7.2.5 Heating zone



This zone, which is present only on some models in the range, keeps the area inside the dashed line at a temperature of approximately 90°C. It is used for warming dishes up or keeping them hot. If the hob is not locked, simply press the button to switch it on. Press the button to switch it off.

7.2.6 Cooking zone lock-out



The cooking zone lock-out function is a user safety functions. It locks out the hob controls to prevent the ceramic cooking zones being switched on accidentally.

Hold down for 1 second to lock out the hob. The hob can be reactivated by holding down again for 1 second.

7.2.7 Cooking zone layout



REAR LEFT



REAR RIGHT



REAR CENTRAL



CENTRAL



FRONT LEFT



FRONT RIGHT



FRONT CENTRAL





OVAL CENTRAL







7.2.8 Timer (on some models only)

Some models are equipped with a 1 to 99-minute cooking timer.

To use the timed cooking, first set the power level by following the instructions given in paragraphs “7.2.2 Single Cooking Zones” and “7.2.3 Dual Cooking Zones”.

Now, with the hob NOT locked out (if it is locked out, press the  key to enable the functions), press the symbol .



Between the symbols  and  of the first active cooking zone, a LED light will turn on to indicate that the minutes to be set will refer to operation of that particular zone.



The automatic operation minutes of the cooking zone can be increased or decreased by using the  and  keys beside .

After 5 seconds have gone by since the last time it is pressed, the timer will start and the cooking zone will operate until the display above the symbol  reaches 0.

At this point the cooking zone will automatically turn off.



It is also possible to use the timed cooking function on more than cooking zone at the same time.

Once the timer is set on the first zone, press  key to shift the timer controls over to the next active zone (the LED light between the symbols  and  of the second active cooking zone will be activated) and then set the cooking duration as previously described.

When the timed cooking is active on several cooking zones at the same time, the display between the symbols  and  of the cooking zone will alternatively turn on and at the same time the minutes display found on the symbol  will show the time remaining for the zone with the LED light on.



7.2.9 Modifying the data set

During timed cooking, each single pressure on the  and  symbols increases or reduces the power of the cooking zone.







To change the remaining time of a zone, you have to press  key until the LED light in the cooking zone turns on. Now it will be possible to change the operating time by working with the symbols  and  of the timer.

7.2.10 Residual heat



Each cooking zone is equipped with a residual heat warning device. After any zone is switched off, a flashing “” may appear on the display. This warns that the cooking zone concerned is still very hot. Cooking can be restarted while the  is flashing; proceed as described in points “7.2.2 / 7.2.3”.

7.2.11 Control circuit board thermal protection

If the cooking zones cause overheating of the internal electronic circuit board, the heat will be switched off automatically. This switches off power to the front zones, and the letters  and  flash alternately on the power leds. If the circuit board does not cool down, power to all the cooking zones is switched off, and the power leds display the text    . Cooking can be resumed once the temperature has dropped below the safety threshold.

7.2.12 Operator Error



If the user makes a mistake when using the push-buttons, an  appears on the power display; it will remain there as long as the user continues to press the button being used incorrectly.

7.2.13 Switching off the cooking zones

The cooking zones are switched off when the operational power display indicates 0. The zone will automatically deactivate 5 seconds after the display shows 0.

If the cooking zones are hot, the blinking residual heat “” will appear after they are switched off.



Instructions for the user

GB-IE

7.2.14 Switching off

To switch the hob off, hold down  for 1 second; this deactivates all cooking zones even if they are in use or the lock-out function is active, and the hob will turn off completely.

If the cooking zones have just been used,  will start flashing a few seconds after the hob is turned off to warn that they are still hot.

7.3 Cooking tips

The table below shows the power values which can be set, with the relative type of food alongside. Setting may vary depending on the amount of food and personal taste.

KNOB SETTING	NUMBER ON THE DISPLAY	TYPE OF FOOD
1	1	To melt butter, chocolate, and the like.
2	2-3	To heat food, keep small amounts of water on the boil, and whip up sauces with egg yolk or butter.
3	4-5	To heat solid or liquid food, keep small amounts of water on the boil, thaw deep-frozen food, cook omelettes of 2 or 3 eggs, fruit and vegetables, and the like.
4	6	To stew meat, fish and vegetables, simmer food, make jams, and so on.
5	7-8	To roast meat, fish, steaks, and liver; to sauté meat, fish, eggs and so on.
6	9	To deep-fry potatoes, etc and to quick-boil water.

For best results and energy saving, only use pans suitable for electric cooking:

- The bottom of the pan must be very thick and perfectly flat; before placing on the cooking hob, make sure that the pan, as well as the cooking hob itself, is perfectly clean and dry.
- To avoid scratching of the cooking hob, never use cast-iron pans or pans with a rough bottom.
- To avoid waste of energy, make sure that the diameter of the pan bottom is the same as that of the circle marked on the hob.

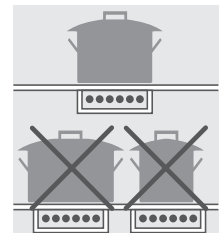



7.4 Holding function "A"

Some models of hob feature a new "standby" function indicated by the appearance of the letter "A" on the display (which normally indicates the zone power level).

This function allows a lower temperature to be obtained on the ceramic hob surface in the selected zone, enabling foods that have already been cooked (e.g. soups, meat after slicing, fish, sauces, etc.) to be kept at the required temperature.

7.4.1 Activating the holding function "A"

After switching on the zone with the display showing 0, press the  key. The display will show the letter "A", indicating that this holding function has been activated. Pressing the  key again switches to power level 9, as is the case on hobs with normal zones. Returning to level 0 and pressing the  key again does not reactivate the "A" function; to activate it, the zone must be switched off and back on.



The holding function must not be activated on a hotplate that is still "hot" since this could activate one of the overheating safety mechanisms with which the electronic hob control is equipped.



8. CLEANING AND MAINTENANCE

Before any intervention, disconnect the power supply of the device.



8.1 Cleaning the ceramic hob



The hob should be regularly cleaned; preferably after every use, once the residual heat warning lights have gone off.

Smudges from aluminium-bottom pans can be easily cleaned off with a cloth dampened in vinegar.

Remove any burnt residues after cooking with the scraper provided; rinse with water and wipe dry with a clean cloth. Regular use of the scraper considerably reduces the need for chemical detergents for the daily cleaning of the hob.

Never use abrasive or corrosive detergents (e.g. cleaning powders, oven sprays, spot-removers, wire sponges).



NEVER USE A STEAM JET TO CLEAN THE APPLIANCE.

9. SOMETHING WRONG?

PROBLEM	POSSIBLE CAUSES	WHAT TO DO?
The hob doesn't work	<ul style="list-style-type: none"> - The hob is not wired in or switched on at the wall. - There is a power failure 	<ul style="list-style-type: none"> - Switch on at the wall - Check power supply
The results of cooking are unsatisfactory	<ul style="list-style-type: none"> - Temperature is too high or too low - Wrong shelf position - Wrong type of dish - Cooking time is incorrect 	<ul style="list-style-type: none"> - Consult cooking tips
The hob smokes	<ul style="list-style-type: none"> - The hob is dirty - Food has spilled over 	<ul style="list-style-type: none"> - Clean the hob once cooking is finished. Let it cool first. - Use a larger pan
The cooking zones do not come on during timed cooking	<ul style="list-style-type: none"> - Timed cooking programming error 	<ul style="list-style-type: none"> - Check the instructions for timer



10. INSTALLATION

10.1 Technical information

Hob type	See rating plate
Electrical connections	220-240V~ 50/60Hz / 380-415V 2N~ 50/60Hz / 380-415V 3N~ 50/60Hz
HOB RATING	Electric
Maximum electrical power	See rating plate

DIMENSIONS OF THE HOB

Width (mm)	290	595	720	900
Depth (mm)	510	510	510	510

10.2 The rating plate



Make sure that the voltage and capacity of the power line conform to the data shown on the plate located under the casing. **Do not remove this plate for any reason..**

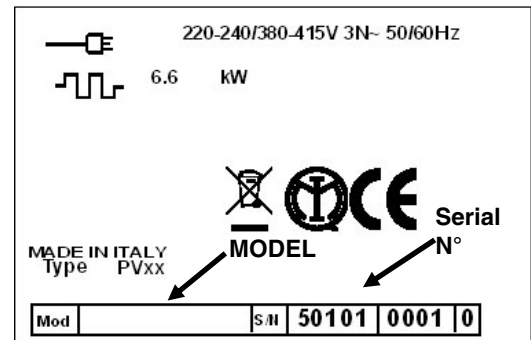

10.3 Electrical connection



IT IS OBLIGATORY FOR THE ELECTRICAL SYSTEM TO BE GROUNDED ACCORDING TO THE METHODS REQUIRED BY SAFETY RULES.



WHEN LINKING UP TO MAINS BY PLUG AND SOCKET, MAKE SURE THAT BOTH ARE COMPATIBLE AND CONNECT BY MEANS OF A POWER CABLE COMPLYING WITH APPLICABLE REGULATIONS.

THE SOCKET MUST BE ACCESSIBLE AFTER THE APPLIANCE HAS BEEN BUILT IN.

NEVER UNPLUG BY PULLING ON THE CABLE.



IMMEDIATELY AFTER INSTALLATION CARRY OUT A BRIEF INSPECTION TEST OF THE HOB, FOLLOWING THE INSTRUCTIONS. IF THE HOB FAILS TO OPERATE, AFTER CHECKING THAT YOU HAVE CARRIED OUT THE INSTRUCTIONS CORRECTLY, DISCONNECT THE APPLIANCE FROM THE ELECTRICAL MAINS AND CONTACT YOUR NEAREST SERVICE CENTRE.

NEVER ATTEMPT TO REPAIR THE APPLIANCE.



IF A PLUG AND SOCKET CONNECTION IS BEING USED MAKE SURE THAT THE PLUG AND SOCKET ARE COMPATIBLE. AVOID USE OF ADAPTERS AND SHUNTS AS THESE COULD CAUSE OVERHEATING AND RISK OF BURNS.



IF A FIXED CONNECTION IS BEING USED FIT POWER LINE WITH AN OMNIPOLAR CIRCUIT BREAKER WITH A CONTACT OPENING GAP EQUAL TO OR GREATER THAN **3 MM** IN AN EASILY ACCESSIBLE POSITION IN PROXIMITY TO THE HOB.



For operation on 380-415 V 3N~: use an - H05V2V2-F type five-core cable (5 x 1,5 mm²).

380-415V 3N~ 1,5 mm²

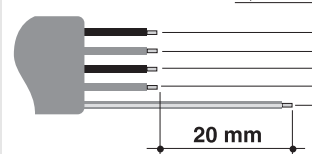

For operation on 380-415 V 2N~: use an - H05V2V2-F type four-core cable (4 x 2,5 mm²).

380-415V 2N~ 2,5 mm²

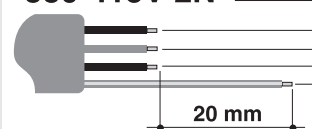

For operation on 220-240 V 3~: use an - H05V2V2-F type four-core cable (4 x 2,5 mm²).

220-240V 3~ 2,5 mm²

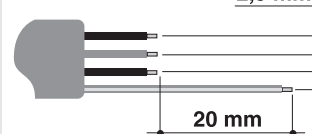

For operation on 220-240 V~: use an - H05V2V2-F type three-core cable. (3 x 4 mm² : hob with 5 cooking zones)

220-240V~ 4 mm²

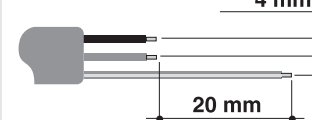

The cable end to be connected to the appliance must be provided with an earth wire (yellow-green) at least 20 mm longer.

READ THE CONNECTION LAYOUT PLATE UNDERNEATH THE APPLIANCE WITH CARE.



If the appliance you have purchased is not fitted with a mains power lead a power lead resistant to a temperature of at least 90°C must be used.

Otherwise, the electrical safety of the appliance may be put at risk.

The manufacturer declines all responsibility for damage to persons or things caused by non-observance of the above prescriptions or by interference with any part of the appliance.



Warning: pass the power cable through hole "A" and fit the cable clamp plate after making the electrical connection.

To fit the plate, simply use the provided bolts to secure it under the casing as shown in the figure.

TYPE 1 TERMINAL BOARD

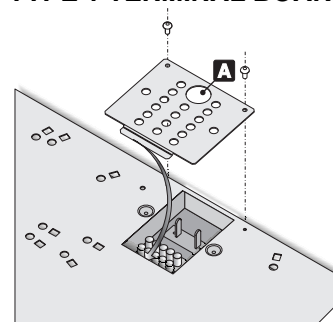

TYPE 2 TERMINAL BOARD

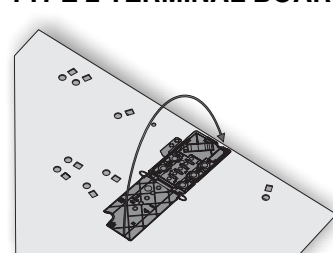

Warning: close the cable clamp after making the electrical connection. Close the terminal board cover by twisting it down.



Instructions for the installer

GB-IE

10.4 POSITIONING OF THE HOB



The following operation requires building and/or carpentry work so must be carried out by a competent tradesman.

Installation can be carried out on various materials such as masonry, metal, solid wood or plastic laminated wood as long as they are heat resistant ($T < 90^{\circ}\text{C}$).

Create an opening with the dimensions shown in the figure in the top surface of the counter, keeping a minimum distance of 50 mm from the rear edge.

This appliance can be mounted against walls higher than the work surface on condition that a certain distance "X" be kept between the appliance and the wall as shown in the figure so as to avoid damage from overheating.

Make sure there is a minimum of **750 mm** between the hob and any shelf that may be installed directly above them.

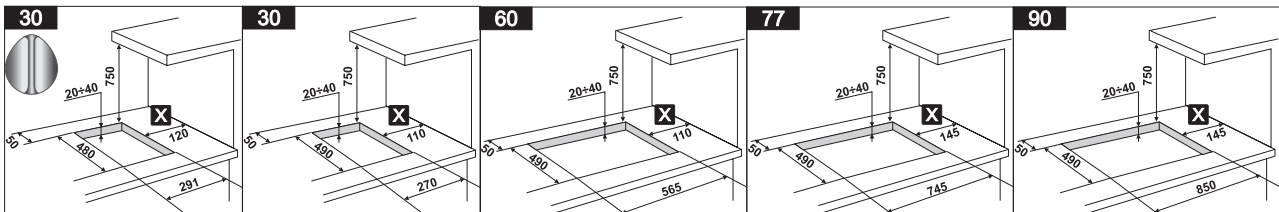

10.5 Mounting

Before mounting the device to the unit, lay the provided adhesive sponge onto the glass surface to separate it from the unit.

After fixing the provided adhesive sponge (B) to the glass, mount the device to the unit with the mounting brackets (A) provided with the device itself, as shown in the figure.

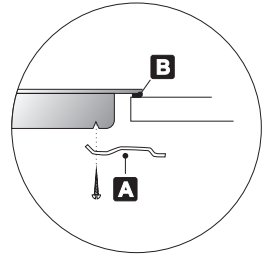

When fixing the hob to the cabinet, use only the holes provided, illustrated here.

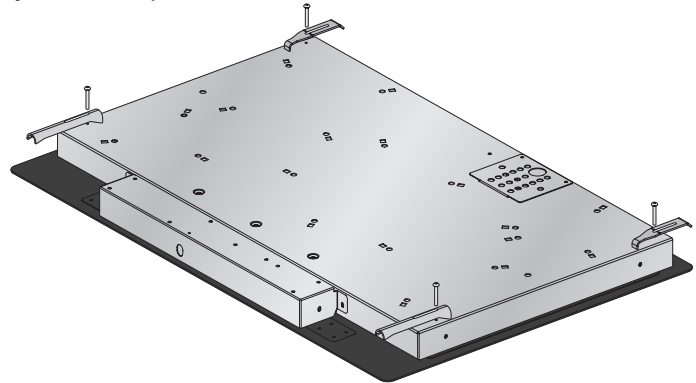
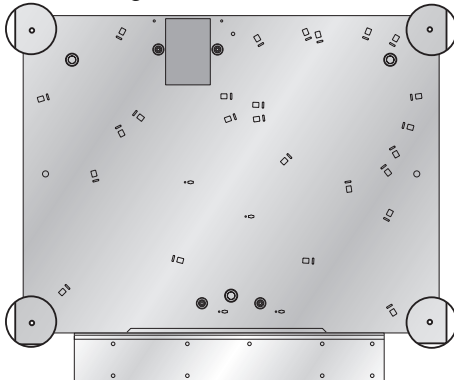

**This appliance must not be built-in above a dishwasher.
Installation of an oven without cooling fan underneath the hob is forbidden.**



Pass the power supply cable through the back of the unit, taking care that it does not touch the bottom casing of the hob or the oven (if any) installed underneath it.



IMPORTANT: when installing the appliance above a cupboard, a dividing shelf, as shown above, must be installed.

If installed above an under-bench oven, this is not required.

Installation of an oven without cooking fan underneath the hob is forbidden.

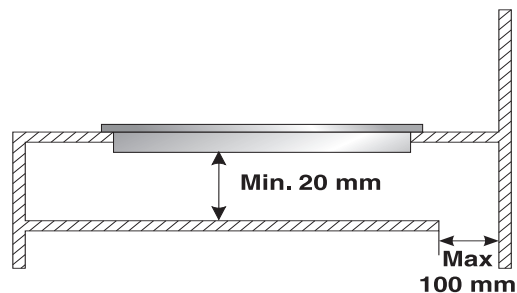

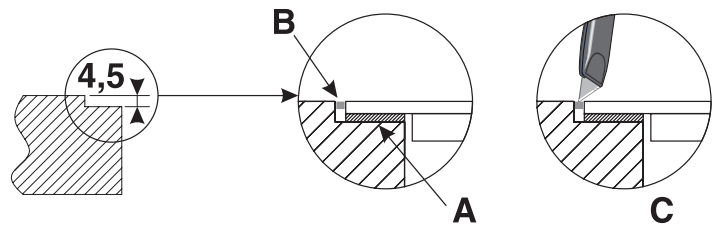
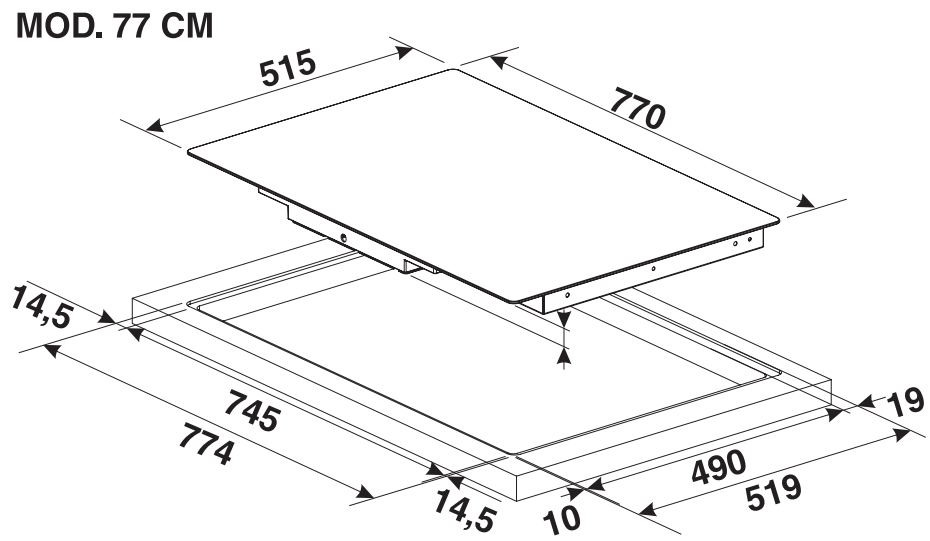
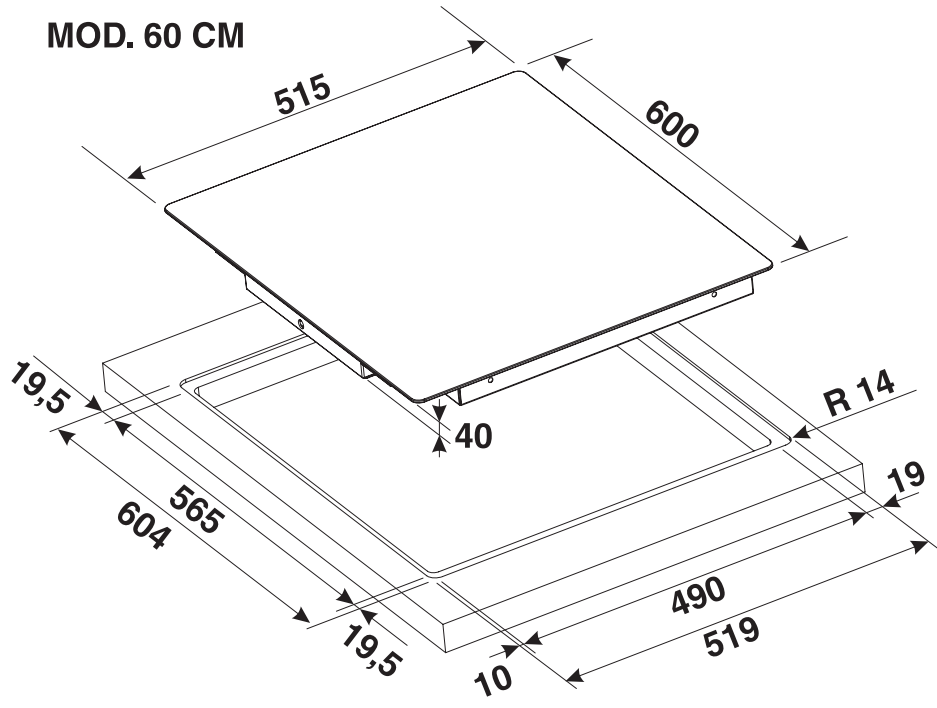

The diagrams illustrate the cutting sizes and additional shaping required for the installation hole if you decide to install the hob flush with the work-top surface. The work-top hole and shaping dimensions are purely guideline; it is essential to refer to your actual ceramic hob before making any cuts. After you have attached the adhesive strip supplied with the hob to the underside of the glass (A) position the hob precisely and centrally in the cut out, and mount it with the mounting brackets. Fill any small gaps between the top of the worktop and the underside of the hob with silicone (B) to create a waterproof seal. Take care to clean any excess silicone from the surfaces before it sets. If it is necessary to remove the hob, cut the silicone with a small sharp blade (C) before trying to remove it.