

Thermador[®]

Care and Use Manual

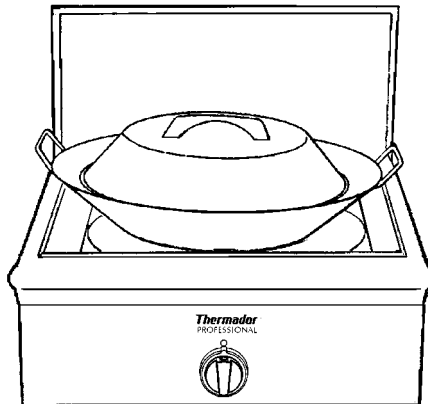
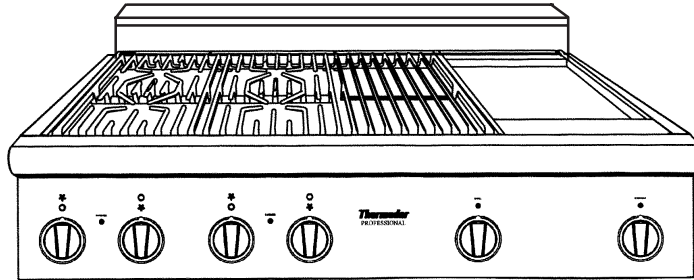

for

Thermador

PROFESSIONAL[®] Cooktops

FOR RESIDENTIAL USE ONLY

48" Models – PSC484GG, PSC484WK, PSC486GD, PSC486GL

36" Models – PSC364GD, PSC364GL, PSC366

24" Model – P24WK

**LE MANUEL DE SOIN ET D'UTILISATION
EN ANGLAIS AVEC ADVERTISSEMENTS EN FRANÇAIS**

A SPECIAL MESSAGE TO OUR CUSTOMERS

Thank you for selecting the Thermador PROFESSIONAL® Cooktop. We recommend that you take time to read this entire booklet before using your new appliance for the first time.

The booklet contains suggestions we believe will be helpful as well as directions for using all the features of this cooktop. Keep it in a handy place, as it has the answers to questions that may occur when you start to cook.

Let us know if we can help you. When you write, please include the model and serial numbers of your cooktop.

Sincerely,

Thermador Test Kitchen Consumer Scientists



WARNING:

If the information in this manual is not followed exactly, a fire or explosion may result causing property damage, personal injury or death.

FOR YOUR SAFETY

- ✓ **Do not store or use gasoline or other flammable vapors and liquids in the vicinity of this or any other appliance.**

AVERTISSEMENT

- ✓ **Ne pas entreposer ni utiliser de l'essence ni d'autres vapeurs ou liquides inflammables dans le voisinage de l'appareil, ni de tout autre appareil.**

WHAT TO DO IF YOU SMELL GAS

- Do not try to light any appliance.
- Do not touch any electrical switch; do not use any phone in your building.
- Immediately call your gas supplier from a neighbor's phone.
- Follow the gas supplier's instruction.
- If you cannot reach your gas supplier, call the fire department.
- Installation and service must be performed by a qualified installer, service agency or the gas supplier.

CE QUI FAIRE SI VOUS SENTEZ LE GAZ

- Ne pas essayer d'allumer aucun appareil.
- Ne pas toucher aucun interrupteur électrique; ne pas utiliser aucun téléphone dans votre bâtiment.
- Appeler immédiatement votre fournisseur de gaz du téléphone d'un voisin. Suivre l'instruction du fournisseur de gaz.
- Si vous ne pouvez pas contacter votre fournisseur, téléphone le service des incendies.
- L'installation et le service doivent être exécutés par un installateur qualifié, une agence de service ou le fournisseur de gaz.

INTRODUCTION

The Thermador PROFESSIONAL® Cooktops are built-in units available in a number of configurations. Models PSC486GD, PSC486GL, PSC484GG and PSC484WK feature a gas cooking surface with six sealed burners and a griddle, six sealed burners and a grill, four sealed burners with a griddle and a grill, or four sealed burners with a wok, respectively. Models PSC364GD, PSC364GL, and PSC366 feature a gas cooking surface with four sealed burners and a griddle, four sealed burners and a grill, or six sealed burners. Models P24WK and PSC484WK have a high output WOK burner rated at 30,000 BTU/HR.

IMPORTANT

All Cooktops having less than 12" (305 mm) horizontal clearance between combustible materials and the back edge of the Cooktop must be installed with a Thermador Low Back Backguard. If more than 12" (305 mm) horizontal clearance exists, a Thermador Island Trim may be used instead of the backguard. Before using the Cooktop, insure that it is equipped with the appropriate Low Back Backguard or Island Trim. Refer to the *Installation Instructions* accompanying this appliance for more information.

Cooktops are shipped by the factory to operate on natural gas. Verify the type of gas being used at the installation site matches the type of gas used by the appliance.

If the location/job site requires a conversion from one type of gas to another, contact the dealer where the unit was purchased or contact Thermador (800/735-4328). The field conversion kit for all Professional cooktops (PSC series) is Thermador Model CTLPKIT. Field conversion must be done by qualified service personal only.



CAUTION:

When connecting the unit to propane gas, make certain the propane gas tank is equipped with its own high-pressure regulator in addition to the pressure regulator supplied with the range. The pressure of the gas supplied to the appliance regulator must not exceed 14" (34.57 mB) water column.

TABLE OF CONTENTS

| | |
|--|---------|
| Introduction | 1 |
| Gas Type Verification | 1 |
| SECTION ONE: General Safety Instructions | |
| Safety | 2 |
| Precautions | 3 |
| SECTION TWO: Before You Begin | |
| Before Using Your Cooktop for the First Time | 5 |
| SECTION THREE: Description | |
| Model & Parts Identification – PSC48 | 6 |
| Model & Parts Identification – PSC36 | 7 |
| Model & Parts Identification – P24WK | 8 |
| SECTION FOUR: Using the Cooktop | |
| Sealed Burners | 9 |
| ExtraLow® Burners | 10 |
| Electronic Igniter | 10 |
| Flame Setting Guidelines | 11 |
| Cookware Recommendations | 12 |
| Specialty Cookware | 13 |
| Surface Burner Cooking Chart | 14 – 15 |
| Using the Grill | 16 – 18 |
| Grill Cooking Chart | 19 – 20 |
| Using the Griddle | 21 |
| Griddle Cooking Chart | 21 |
| SECTION FIVE: Wok Operation | |
| Before Using Prepare Wok | 5 |
| Using the Wok | 22 |
| Wok Operation | 23 |
| SECTION SIX: Care and Maintenance | |
| Cooktop and Wok Cleaning Chart | 24 – 28 |
| SECTION SEVEN: Before Calling For Service | |
| Do-It-Yourself Maintenance | 29 |
| Before Calling For Service | 30 |
| Data Rating Plate | 30 |
| Warranty | 33 |

TESTED IN ACCORDANCE WITH ANSI Z21.1 CURRENT ISSUE, STANDARD FOR HOUSEHOLD COOKING GAS APPLIANCES. IN CANADA TESTED IN ACCORDANCE WITH CAN/CGA 1.1 DOMESTIC GAS RANGES, CURRENT ISSUE.

Check your local building codes for the proper method of installation. In the absence of local codes, this unit should be installed in accordance with the National Fuel Gas Code No. Z223.1 Current Issue and the National Electrical Code ANSI/NFPA No. 70 Current Issue or the Can B149 Installation Codes for Gas Burning Appliances and C22.1 Canadian Electrical Code Part I.

SAFETY

ELECTRICAL REQUIREMENTS AND GROUNDING INSTRUCTIONS

PLEASE READ CAREFULLY

All Cooktop models and the Wok require an electrical circuit rated at 120 volts, 60 Hz., 15 Amps.

For personal safety, this appliance must be connected to a properly grounded and polarized electrical power supply.

Always disconnect the electrical plug from the wall receptacle before servicing this unit.

See *Installation Instructions* for electrical requirements and grounding instructions.

DO NOT UNDER ANY CIRCUMSTANCES CUT OR REMOVE THE SEPARATE GROUND WIRE OR THE THIRD (GROUND) PRONG FROM THE POWER CORD PLUG.

It is the personal responsibility and obligation of you, the user, to have this appliance connected to the electrical power supply in accordance with the National Electrical Code and/or applicable local codes and ordinances by a qualified electrician.

It is recommended that a dedicated circuit servicing this appliance be provided.



CAUTION - ALL MODELS

In Case of an Electrical Failure

If for any reason a gas control knob is turned ON and there is no electric power to operate the electronic igniters on the cooktop burners, **turn OFF the gas control knob and wait 5 minutes** for the gas to dissipate before lighting the cooktop burner manually.

To light the cooktop burners and grill manually, carefully hold a lighted match to the burner ports and turn the gas control knob to HI. During a power failure, you can manually light the standard cooktop burners and grill only, but each must be lit with a match.

If the grill is left on and power is restored, the grill will relight.

DO NOT attempt to light the two left burners manually. These burners are equipped with the ExtraLow® feature and cannot be lit manually.

See Pages 11 and 29 for additional information on manually lighting the burners.

PRECAUTIONS

SAFETY PRACTICES TO AVOID PERSONAL INJURY

Your new Thermador PROFESSIONAL® Cooktop has been designed to be a safe, reliable appliance when properly used and cared for. If not properly used, it could be dangerous. Read all instructions in this Care and Use Manual carefully before using this cooktop.

 **WARNING:** These precautions will reduce the risk of burns, electric shock, fire, and injury to persons. Use extreme care when using this restaurant caliber cooktop as this appliance provides intense heat and can increase the accident potential.

- **When using kitchen appliances, these basic safety precautions must be followed:**

- **Insure proper installation and servicing.** Follow the installation instructions provided with this product. Have the cooktop installed and grounded by a qualified technician.

- **Have the installer show you where the gas supply shut-off valve is located** so that you know how and where to turn off the gas to the cooktop.

- **If you smell gas,** your installer has not done a proper job of checking for leaks. If the connections are not perfectly tight, you can have a small leak and therefore a faint gas smell. Finding a gas leak is not a “do-it-yourself” procedure. Some leaks can only be found with the burner control in the ON position and this must be

done by a qualified service technician. See inside the front cover regarding gas leaks.

- In the event a burner goes out and **gas escapes**, open a window or a door. Do not attempt to use the cooktop until the gas has had time to dissipate. **Wait at least 5 minutes before using the Cooktop.**

- **Do not repair or replace any part of the appliance** unless specifically recommended in this manual. All other servicing should be referred to a qualified technician.

- **Children should not be left alone or unattended in an area where appliances are in use.** They should never be allowed to sit or stand on any part of the appliance.

 **CAUTION:** Do not store items of interest to children above the cooktop or at the back of it. If children should climb onto the appliance to reach these items, they could be seriously injured.

- **Never use any part of the cooktop for storage. Flammable materials can catch fire and plastic items may melt or ignite.**

- If the cooktop is near a window, **be certain the curtains do not blow over or near the cooktop burners;** they could catch on fire.

- **DO NOT USE WATER ON GREASE FIRES.** Turn appliance off and smother fire with baking

soda or use a dry chemical or foam-type extinguisher.

- **Never let clothing, pot holders, or other flammable materials come in contact with or too close to any element, burner or burner grate** until it has cooled. Fabric may ignite and result in personal injury.

- **Use only dry pot holders.** Moist or damp pot holders on hot surfaces may cause burns from steam. Do not use a towel or other bulky cloth in place of pot holders. Do not let pot holders touch hot elements, hot burners, or burner grates.

- **For personal safety, wear proper apparel.** Loose fitting garments or hanging sleeves should never be worn while using this appliance. Some synthetic fabrics are highly flammable and should not be worn while cooking.

- **Do not use aluminum foil as a shield** against food spills or drippings around the burners or control panel area. This could obstruct the flow of combustion and ventilation air. This can damage the finish of the cooktop.

 **Warning:** The appliance is for cooking. Based on safety considerations, never use the cooktop to warm or heat a room. Such use can damage the cooktop.

- When using the cooktop: **DO NOT TOUCH THE BURNER GRATES OR THE IMMEDIATE SURROUNDING AREAS** adjacent to the burners may become hot enough to cause burns.

PRECAUTIONS

- **Never leave the cooktop unattended** when using high flame settings. Boil-overs cause smoking and greasy spills that may ignite. More importantly, if the burner flames are smothered, unburned gas will escape into the room. See inside the front cover regarding gas leaks.
- **Only certain types of glass, heatproof glass-ceramic, ceramic, earthenware or other glazed utensils are suitable for cooktop use.** This type of utensil may break with sudden temperature changes. Use only on low or medium heat settings according to the utensil manufacturer's directions.
- **Do not heat unopened food containers;** a buildup of pressure may cause the container to burst.
- During cooking, **set the burner control so that the flame heats only the bottom of the pan and does not extend beyond the bottom of the pan.**
- Use caution to insure that drafts like those from forced air vents or fans do not blow flammable material toward the flames or push the flames so that they extend beyond the edges of the pot.
- **Always use utensils that have flat bottoms, large enough to cover the burner.** The use of undersized utensils could expose a portion of the flame and may result in ignition of clothing.
- To minimize burns, ignition of flammable materials and unintentional spills, **position handles of**

utensils inward so they do not extend over adjacent work areas, cooking areas or the edge of the cooktop.

- **Hold the handle of the pan** to prevent movement of the utensil when stirring or turning food.

- **Do not use the grill for cooking excessively fatty meats or products which promote flare-ups.**

- The optional **cutting board accessory must be removed before operating the griddle.**

- **GREASE IS FLAMMABLE.** Let hot grease cool before attempting to handle it. Avoid letting grease deposits collect. Clean after each use.

- For proper lighting and performance of the burners, **keep the ports clean.** It is necessary to clean these when there is a boil over or when the burner does not light even though the electronic igniters click. See Page 24.

- **Clean the cooktop with caution.** Avoid steam burns; do not use a wet sponge or cloth to clean the cooktop while it is hot. Some cleaners produce noxious fumes if applied to a hot surface. Follow directions provided by the cleaner manufacturer.

- **Be sure all cooktop controls are turned off and the cooktop is cool** before using any type of aerosol cleaner on or around the cooktop. The chemical that produces the spraying action could, in the presence of heat, ignite or

cause metal parts to corrode. Service should only be done by authorized technicians. Technicians must disconnect the power supply before servicing this unit.

- **Clean the ventilator hood and filters above the cooktop frequently** so grease from cooking vapors does not accumulate on them.

- **In case of fire or when intentionally "flaming" liquor or other spirits on the cooktop, follow hood manufacturer's instructions.**

- **Install a smoke detector** in or near the kitchen.

- If a burner goes out and **gas escapes**, turn the control knob off. Open a window or door. Do not attempt to use the cooktop until the gas has had time to dissipate.

- **California Proposition 65 Warning:** The burning of gas cooking fuel generates some by-products which are on the list of substances which are known by the State of California to cause cancer or reproductive harm. California law requires businesses to warn customers of potential exposure to such substances. To minimize exposure to these substances, always operate this unit according to the instructions contained in this booklet and provide good ventilation to the room when cooking with gas.

SAVE THESE INSTRUCTIONS

BEFORE USING YOUR COOKTOP FOR THE FIRST TIME

1. Check that you have all the items listed for your model, as shown in the chart below.
2. **Record the Model and Serial number of your appliance as described on Page 30.** This may be used for any future contacts with your servicer or the factory. Enter this information on the Product Registration Card included with this product; then mail it to the indicated address.
3. **Optional Accessories:** Grill Cover, Griddle Cover, Chopping Board for built-in griddle area. A portable griddle and other accessories are available from your Thermador dealer.

| Description | PSC364GD | PSC364GL | PSC366 | PSC484GG | PSC484WK | PSC486GD | PSC486GL | P24WK |
|---------------------------|----------|----------|--------|----------|----------|----------|----------|-------|
| Star™ Burner caps | 4 | 4 | 6 | 4 | 4 | 6 | 6 | |
| Burner Grates | 2 | 2 | 3 | 2 | 2 | 3 | 3 | |
| Control Knobs | 5 | 5 | 6 | 6 | 5 | 7 | 7 | |
| Cast Iron Grill Grate | | | | | | | | |
| Stainless Steel Radiant | | | | | | | | |
| Removable Griddle | | | | | | | | |
| Wok Ring | | | | | | | | |
| Wok Pan and Lid | | | | | | | | |
| Product Registration Card | | | | | | | | |
| Backguard | * | * | * | * | * | * | * | * |
| Installation Instructions | | | | | | | | |

* Backguard or Island Trim must be ordered separately. These are not included with the cooktop shipment.

BEFORE USING YOUR WOK THE FIRST TIME

Remove all packaging materials and temporary labels from the Wok Pan.

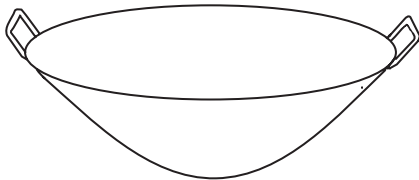

1. For Models P24WK and PSC484WK, check that you have these items:
 - One Wok Pan with Lid and Trivet.
2. The first time the Wok Pan is used, clean the surface thoroughly with hot soapy water. **The initial cleaning is needed to remove the protective oil coating.** Dry thoroughly.
3. Apply a light coat of vegetable oil (do not use corn oil) to the entire inside and outside surface with a paper towel.
4. Heat the Wok Pan on a medium setting until cooking surface turns golden brown. Cool wok.
5. Repeat this procedure several times. This seasoning seals the pores of the metal, keeps food from sticking, and prevents the Wok from rusting.
6. Wipe off excess oil before using or storing the Wok Pan. Do not scour because scouring will remove seasoning.

BEFORE USING YOUR GRIDDLE THE FIRST TIME

Clean the surface with hot soapy water. Rinse thoroughly with clear water. The griddle is now ready to use.

MODEL and PARTS IDENTIFICATION for 48" MODELS

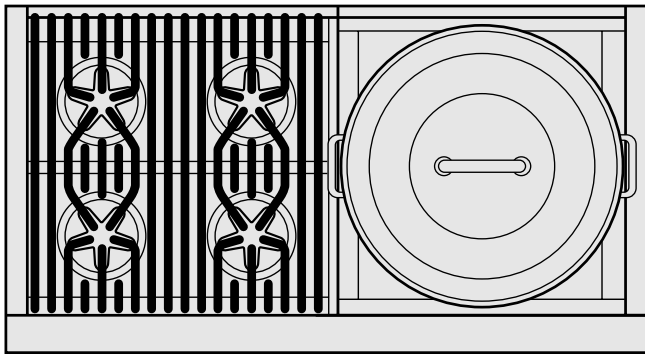

MODEL PSC484WK
(4 Burners and Wok)

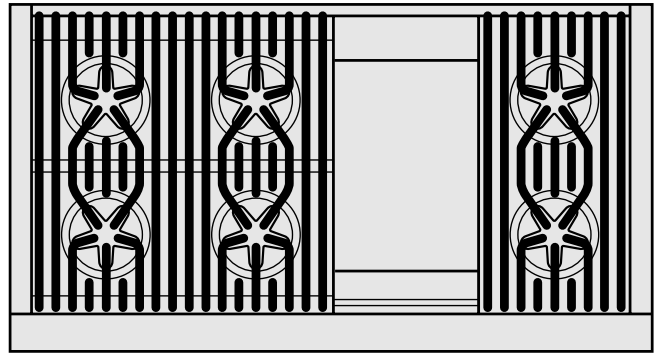

MODEL PSC486GD
(6 Burners and Griddle)

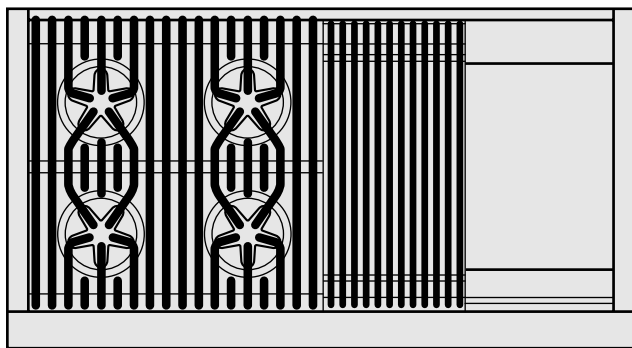

MODEL PSC484GG
(4 Burners and Griddle and Grill)

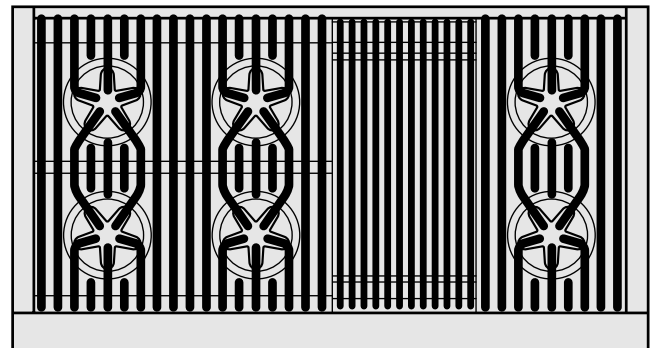

MODEL PSC486GL
(6 Burners and Grill)

Key for PSC48 Models

- 1 – 12" Low Back or Island Trim (ordered separately)
- 2 – Burner Grates & Burners
- 3 – Grill (PSC484GG and PSC486GL)
- 4 – Griddle (PSC484GG and PSC486GD)
- 5 – Control Knobs, ExtraLow® Burners
- 6 – Control Knobs, Standard Burners
- 7 – Control Knob, Grill
- 8 – Control Knob, Griddle Thermostat

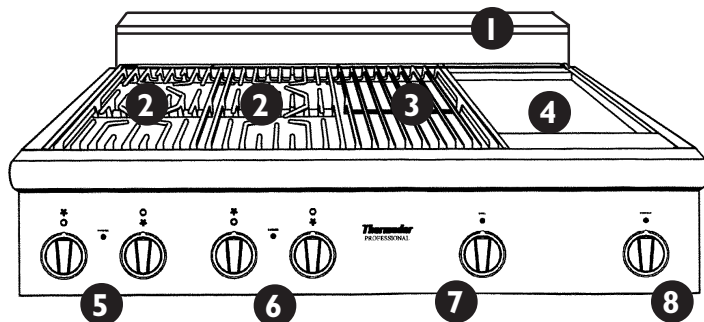

Model PSC484GG

MODEL and PARTS IDENTIFICATION for 36" MODELS

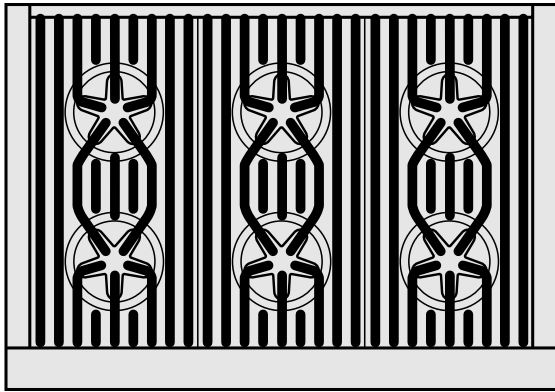

MODEL PSC366
(6 Burners)

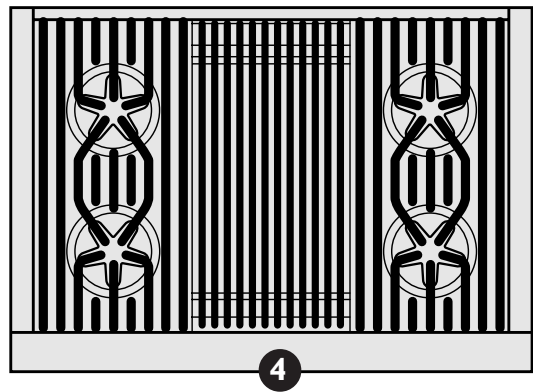

MODEL PSC364GL
(4 Burners and Grill)

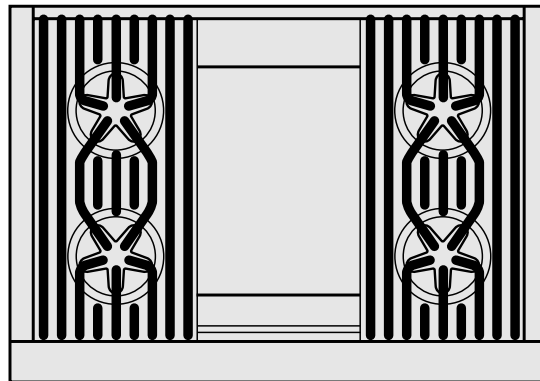

MODEL PSC364GD
(4 Burners and Griddle)

Key for PSC36 Models

- 1 – 12” Low Back or Island Trim (ordered separately)
- 2 – Burner Grates & Burners
- 3 – Griddle (PSC364GD)
- 4 – Grill (PSC364GL) – shown in top view
- 5 – Control Knobs, ExtraLow® Burners
- 6 – Control Knob, Griddle Thermostat (PSC364GD)
- 7 – Control Knobs, Standard Burners

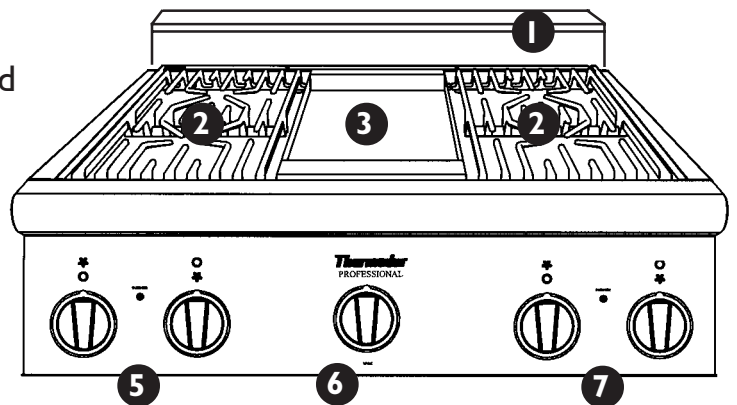

Model PSC364GD

MODEL and PARTS IDENTIFICATION for 24" MODELS

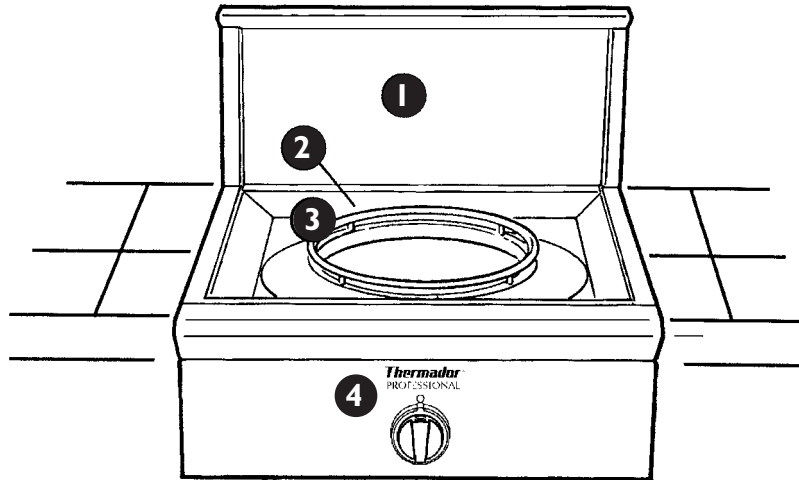

MODEL P24WK

Key for Model GP24WK and PSC484WK

- 1 – Low Back Guard (shown). Optional Island Trim available. (Low Back or Island Trim must be ordered separately.)
- 2 – 24" Wok cooktop
- 3 – Wok pan support ring
- 4 – Control knob
- 5 – Wok pan and lid
- 6 – Large Kettle/Pot (not provided)
- 7 – Wok Trivet

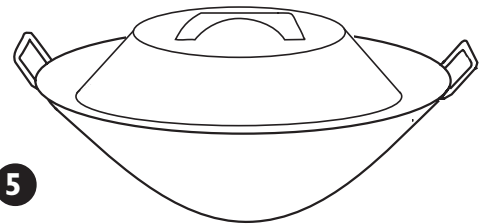

Wok Pan with Lid

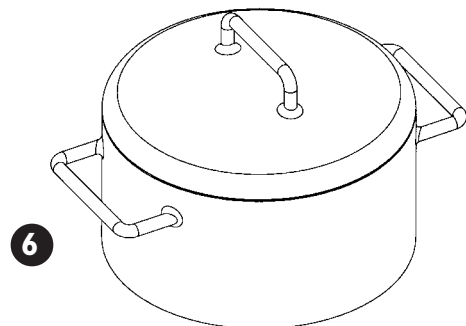

7

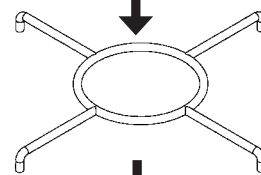

3

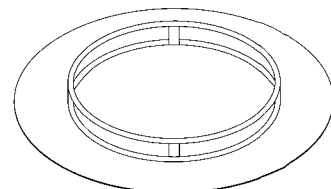

Wok Trivet Assembly

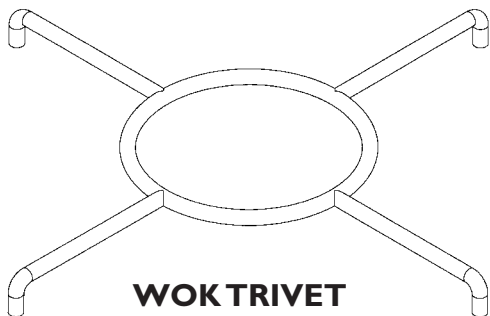

WOK TRIVET

Fits over wok pan support ring for large pots used over wok burner.
(see right)

USING THE COOKTOP

Sealed Burners

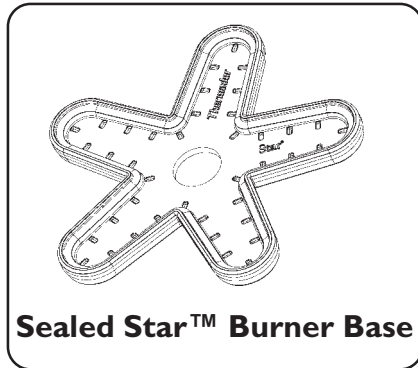

The cooktop features four or six gas surface burners; each rated at 15,000 BTU/HR. The burners are sealed to the stainless steel top frame to prevent liquid spills from accumulating below the top surface, making it easier to clean. On all models, the two left burners have the exclusive ExtraLow feature; the remaining burners are standard. Each burner has its own control knob.

CONTROL KNOBS

The control knobs for two sealed gas burners, one in front and one in the rear, are located directly in front of and below the pair of burners on the control panel.

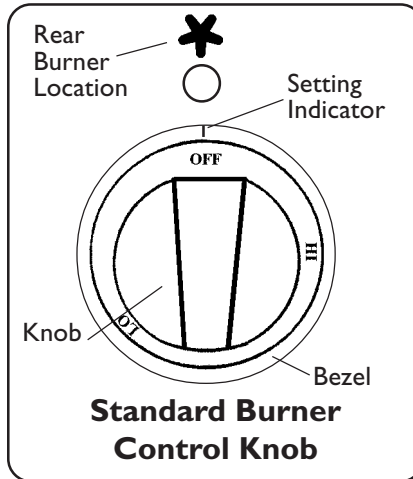

The icon above each control shows whether the burner position is in the front or in the rear. A solid star indicates the location of the burner controlled by that particular knob. The drawing above shows the knob controlling the rear burner.

OPERATION OF THE BURNERS

- Press in on the knob and turn it counter-clockwise to the HI setting.
- The igniter for the selected sealed burner clicks and sparks.
- After flame ignition, the igniters stop clicking.
- Rotate the knob to any flame setting between HI and LO.
- The Blue Burner Signal Light, between the burners, will light when adjacent burners are lit. They will remain on until the burner is turned off.

BTU Output for Standard Burners

- HI is equivalent to 15,000 BTU/HR.
- LO is equivalent to 2,200 BTU/HR.

BTU Output for ExtraLow® Burners

- HI is equivalent to 15,000 BTU/HR.
- LO is equivalent to 3,000 BTU/HR.
- XLO is equivalent to 370 BTU/HR.

ExtraLow® Burners

The controls for the two left burners, front and rear, have flame settings even lower than the standard LO settings.

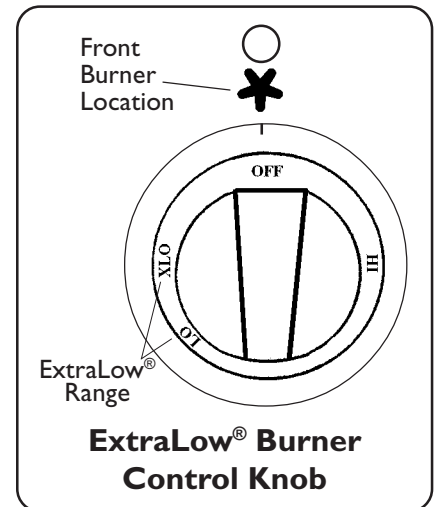

The drawing shows that the control knob has an additional range between the LO and XLO settings. When the knob is set within this range, the flame pulses off and on. By varying the length of time the flame is off and on, the heat is reduced even further to cook delicate foods. For example, these very low settings are suitable for simmering and poaching, melting chocolate and butter, holding cooked foods at temperatures without scorching or burning, etc.

Operation of the ExtraLow Burners

- XLO, the very lowest setting, is achieved by cycling the flame ON for approximately 8 seconds and OFF for 52 seconds of each minute.
- When the knob is set just below the LO setting, the flame will cycle ON for approximately 52 seconds and OFF for 8 seconds of each minute.
- To vary the amount of low heat to suit the food and quantity, the control can be set anywhere within the LO and XLO range marked on the knob.

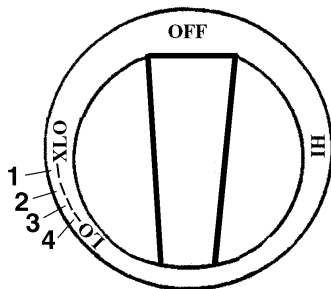

ExtraLow Settings

- The number and dash designations, shown in the drawing, are for reference only. **They do not actually appear on the knob.** The number indicates the position of the flame setting as represented on the cooking chart, pages 14 and 15, with #4 being hotter than #1.

ExtraLow Techniques

- The type and quantity of food affects which setting to use.
- The pan selected affects the setting. Its size, type, material, and whether a lid is used, all affect the consistency of the cooking temperature.

- To maintain a low or simmer heat, bring food to a rolling boil. Stir well, then cover the pan and lower the heat to a setting just below LO.
- Check periodically to see if the control knob should be turned to another setting.
- If an over-size pan is used, the simmer action may occur mainly in the center of the pan. To equalize the temperature throughout the food, stir the food around the outer edges of the pan into the food in the center.
- It is normal to stir food occasionally while simmering. This is especially important when simmering for several hours, such as for a homemade spaghetti sauce or beans.
- When lowering the flame setting, adjust it in small steps.
- If the setting is too low to hold a simmer, bring the food back to a boil before re-setting to a higher heat.
- It is normal not to see simmer bubbles immediately after the food has been stirred.
- There may be bubbling when the flame cycles ON and no bubbles when the flame is OFF. Even when the flame is OFF, there will be steam and a slight quiver on the liquid's surface.

Electronic Single Point Ignition

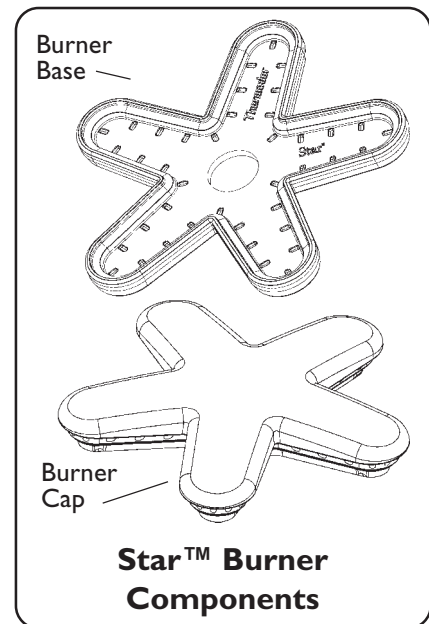

Each burner has its own electronic igniter that sparks when the burner is turned on. Each burner should light in 4 seconds or less. If a burner does not light, check to see that the cap is positioned correctly on the base. **Do not touch the burners when the igniters are sparking.** If a burner fails to ignite, refer to the section on Page 30 "Before Calling for Service."

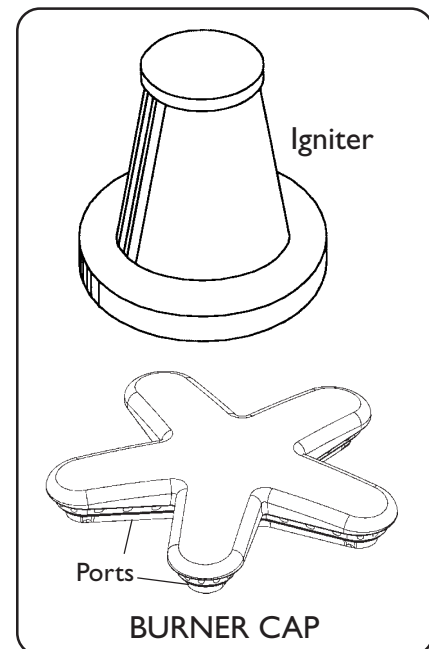

AUTOMATIC RE-IGNITION

If any one or more burners or grill blow out, the electronic igniter automatically sparks to re-light the flame. **Do not touch the burners when the igniters are sparking.**

IMPORTANT:

- For proper combustion do not use the cooktop without the burner grates in place.
- There is a slight sound associated with gas combustion and ignition. This is a normal condition.
- On cooktops using propane gas (LP), a slight “pop” sound may be heard at the burner ports a few seconds after the burner has been turned off.

POWER FAILURE

- In the event of a power failure, **only the standard burners and grill can be manually lit.** It is necessary to light each one individually.
- If the cooktop is being used when the power failure occurs, turn **all** knobs to the OFF position.
- The standard burners and grill can be lighted by holding a match at the ports and turning the control knob to the HI position. Wait until the flame is burning all around the burner cap or U-shaped burner before adjusting the flame to the desired height.
- Neither ExtraLow burner can be used during a power failure. **Be sure to turn them off.**
- If either ExtraLow® burner is on when a power failure occurs, they cannot be turned back on until both knobs are first turned off.
- The griddle and wok burners cannot be used during a power failure.
- If you smell gas, refer to safety precautions listed inside the front cover.



WARNING

In the event of a power failure, all knobs are to be turned to the OFF Position. Only the standard burners and the grill can be lit manually.

FLAME HEIGHT

- The correct flame height depends on 1) size and material of pan being used; 2) food being cooked; and 3) amount of liquid in the pan.
- Never extend the flame beyond the base of the pan.
- Use a low or medium flame for pan materials that conduct the heat slowly, such as porcelain coated steel or glass-ceramic.

FLAME DESCRIPTION

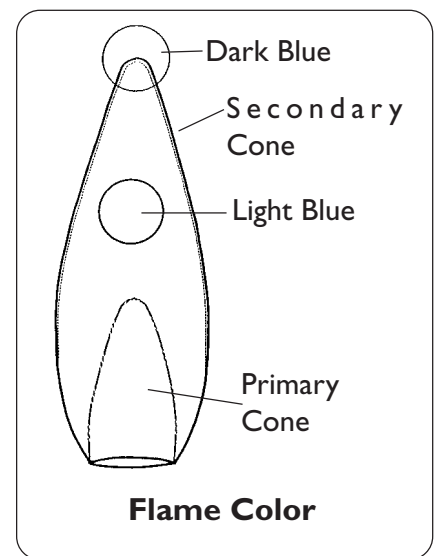

- The burner flame color should be blue with no yellow on the tips. It is not uncommon to see orange in the flame color; this indicates the burning of airborne impurities in the gas and will disappear with use.
- With propane (LP) gas, slight yellow tips on the primary cone are normal.
- The flame should burn completely around the burner cap. If it doesn't, check that the cap is positioned correctly on the base and that the ports are not blocked.
- The flame should be stable with no excessive noise or fluttering.

COOKWARE RECOMMENDATIONS

SAFETY PRECAUTIONS:

- ▶ Food packaged in aluminum foil should not be placed directly on the burner grate. Aluminum foil can melt during cooking.
- ▶ Do not let plastic, paper or cloth come in contact with a hot burner grate. They may melt or catch fire.
- ▶ Never let a pan boil dry. This can damage your pan and the cooking surface.

- For best cooking results, use professional quality pans with metal handles. (Plastic handles can melt or blister, if the flame extends up the side of the pan.) Professional quality pans are found at restaurant supply stores and gourmet specialty shops. All cookware should have these characteristics: good heat conductivity, good balance, correctly sized base diameter, a heavy, flat base, and a proper fitting lid.
- Aluminum and copper are pan materials that conduct the heat quickly and evenly. These metals are sometimes attached to the base or in the core between stainless steel.

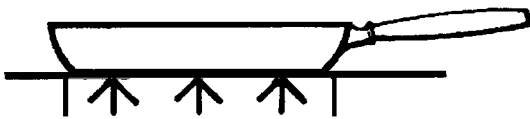

BALANCED PAN

- Balance is important for stability and even cooking. The handle must not be heavier than the pan and tilt it unevenly. A pan must sit level on the grate without rocking or wobbling.

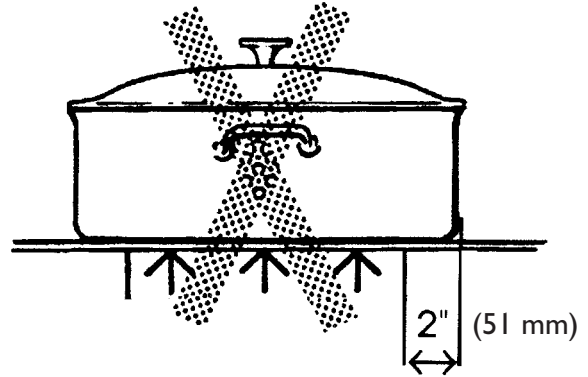

BASE DIAMETER

- Select the base diameter to match the diameter of the flame. The diameter of the flame should be the same size as the pan base or slightly smaller. Oversize or under size pans sacrifice cooking performance. A 5-1/2" (140 mm) base size is generally the smallest recommended.

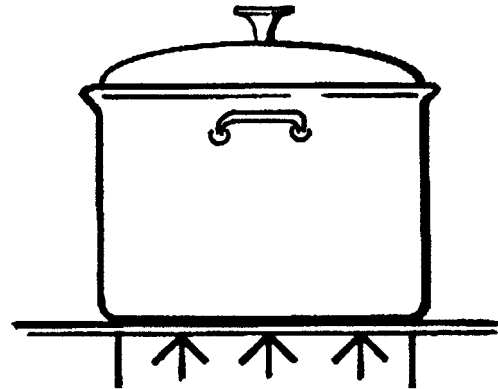

FLAT BASE PAN

- A heavy, flat base is more apt to remain flat when heated. Pan bases that are warped, dented, ridged or too lightweight will heat unevenly. Heat and cool pans gradually to avoid sudden temperature changes which tend to distort cookware. Do not add cold water to a hot pan.

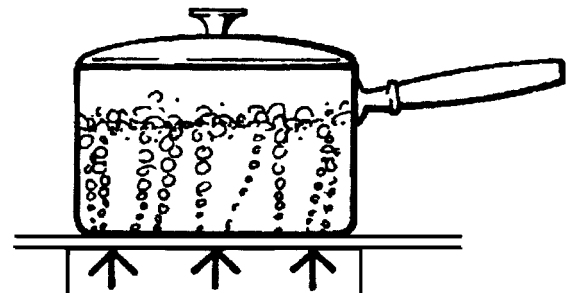

COVERED PAN

- A properly fitting lid will shorten cooking time and make it possible to use lower heat settings.

SPECIALTY COOKWARE

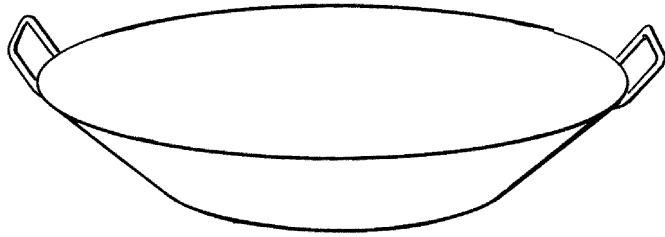

FLAT-BOTTOM WOK PAN

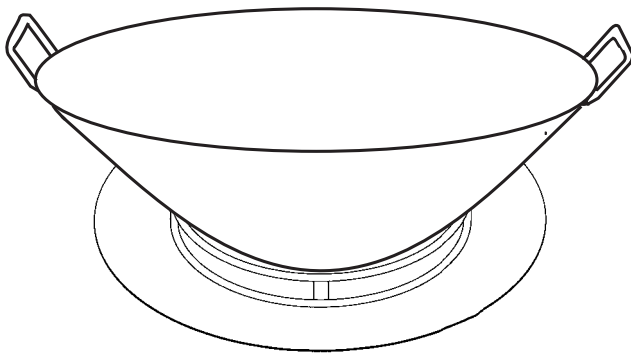

**ROUND BOTTOM WOK
IN SUPPORT RING**

- **Woks** – Either flat based or round bottom woks with the accessory ring can be used on models without a built-in wok burner. Round bottom woks must be used with a support ring. Place the “F” on the accessory ring facing to the front.
- **Canners and Stock Pots** – Select one with a base diameter that extends no more than 2 inches (51mm) beyond the grate.

Standard Size Water Bath Canner

21 to 22 quarts (19.95 to 20.9 liters), with an 11 to 12 inch base (279 to 305 mm) and a 9 to 11 inch depth (229 to 279 mm).

Standard Size Pressure Canner

8 to 22 quarts (7.6 to 20.9 liters)), with an 8 to 11 inch base (203 to 279 mm) and a 6-1/2" to 12 inch depth (165 - 305 mm).

Canning Tips:

- A flat base pan is preferred to one with a concave, convex or rippled base.
- When using two canners at the same time, use staggered burners. Do not block air to the burners. A flame needs the right amount of air for complete combustion.
- Use a cover on a canner when bringing the contents to a boil.
- Once the contents have reached a boil on HI, use the lowest flame possible to maintain the boil or pressure.
- Canning produces a large amount of steam. Take precautions to prevent burns.

COOKING CHART

Suggestions for Using the Chart

Use the chart on Pages 14 and 15 as a guide. The settings you use will vary depending on the pans selected and the starting temperature of the food.

On the chart, the “Finish Setting” has been separated for the standard and ExtraLow burners. There may or may not be a change between the two burner settings.

The ExtraLow setting can be either a cooking or a holding setting.

Raise or lower the flame setting gradually. Allow time for the pan and the food to adjust to the new setting.

Section Four: Using the Cooktop

SURFACE BURNER COOKING CHART

See Chart Suggestions on Page 13.

| Food | Start Setting | Finish Setting Standard Burners | Finish Setting ExtraLow® Burners |
|--|--|---|---|
| BEVERAGES Cocoa | Med. – heat milk, cover | LO – finish heating | XLO – keep warm, cover* |
| BREADS French Toast, Pancakes, Grilled Sandwiches | Med. – preheat skillet | Med. Lo to Med. – cook | Same as Standard |
| BUTTER Melting | | XLO – to hold | 4 to 3 – allow 5 to 10 minutes to melt |
| CEREALS Cornmeal, Grits, Oatmeal | HI – cover, bring water to a boil, add cereal | Med. Lo to Med. – finish cooking according to package directions | XLO – to hold, cover* |
| CHOCOLATE Melting | | Use XLO | 2 to XLO – allow 10 to 15 minutes to melt XLO – to hold* |
| DESSERTS Candy | Med. Lo to Med. – cook following recipe | Med. Lo to Med. | Same as Standard |
| Pudding and Pie Filling Mix | Lo to Med. cook according to package directions | Lo | Same as Standard |
| Pudding | Med. Lo – Bring milk to a boil | Use XLO | 3 to 2 – to cook |
| EGGS Cooked in Shell | HI – cover, bring water to a boil, add eggs, cover | Use XLO | XLO – cook 3 to 4 minutes for soft cooked; or 15 to 20 minutes for hard cooked |
| Fried, Scrambled | Med. to Med. HI – melt butter, add eggs | Lo to Med. Lo finish cooking | XLO – to hold for a short period* |
| Poached | HI – bring water to the steaming point, add eggs | 4 to 3 - finish cooking | Same as Standard |
| MEAT, FISH, POULTRY Bacon, Sausage Patties | HI – until meat starts to sizzle | Med. Lo to Med. finish cooking | Same as Standard |
| Braising: Swiss Steak, Pot Roast, Stew Meat | HI – melt fat, then brown on Med. HI to HI , add liquid, cover, | Use XLO | 3 to 2 – simmer until tender |
| Quick Frying: Breakfast Steaks | Med. HI to HI – preheat skillet | Med. HI to HI – fry quickly | Same as Standard |
| Frying: Chicken | HI – heat oil, then brown on Med. | LO cover, finish cooking | Same as Standard |
| Deep Frying: Shrimp | HI – heat oil | Med. HI to HI – to maintain temperature | Same as Standard |
| Pan Frying: Lamb Chops, Thin Steaks, Hamburgers, Link Sausage | HI – preheat skillet | Med. to Med. HI – brown meat | 4 to 3 – to hold, covered 3 to 2 – to hold, uncovered |
| Poaching: Chicken, whole or pieces, Fish | HI – Cover, bring liquids to a boil | Use XLO | 2 to 1 – to finish cooking |

Section Four: Using the Cooktop

SURFACE BURNER COOKING CHART

| Food | Start Setting | Finish Setting Standard Burners | Finish Setting ExtraLow® Burner |
|---|---|--|---|
| Simmering: Stewed Chicken, Corned Beef, Tongue, etc. | HI – cover, bring liquid to a boil | | 4 to 1 – simmer slowly |
| PASTAS Macaroni, Noodles, Spaghetti | HI – bring water to a boil, add pasta | Med. Hi to HI – to maintain a rolling boil | Same as for Standard Burners |
| POPCORN (use a heavy, flat bottom pan) | HI – cover, heat until kernels start to pop | Med. to Med. Hi – finish popping | Same as for Standard Burners |
| PRESSURE COOKER Meat Vegetables | Med. Hi to HI – build up pressure HI – build up pressure | Med. Lo to Med. – maintain pressure Med. Lo to Med. – maintain pressure | Same as for Standard Burners Same as for Standard Burners |
| RICE | HI – cover, bring water to a boil, add rice, cover | | 4 to 2 – cook according to package directions XLO – to hold, cover |
| SAUCES Tomato Base | Med. Hi to HI – cook meat/vegetables, follow recipe | | 2 to XLO – simmer (2 to 3 to thicken sauce, uncovered). |
| White, Cream, Bernaise, | Med. Lo – melt fat, follow recipe | LO to Med. Lo – finish cooking | XLO – to hold, cover* |
| Hollandaise | Lo to Med. Lo | XLO | XLO – Lowest setting |
| SOUPS, STOCK | HI – cover, bring liquid to a boil | | 3 to 2 – simmer XLO – to hold, cover* |
| VEGETABLES Fresh | HI – cover, bring water and vegetables to a boil | Med. Lo to Med. – cook 10 to 30 minutes, or until tender | XLO – to hold, cover |
| Frozen | HI – cover, bring water and vegetables to a boil | Med. Lo to Med. – cook according to package directions | Same as for Standard Burners |
| Deep Frying | HI – heat oil | Med. to Med. Hi – maintain frying temperature | Same as for Standard Burners |
| In Pouch | HI – cover, bring water and vegetables to a boil | LO to Med. Lo – cook according to package directions | Same as for Standard Burners |
| Saute | HI – heat oil or melt butter, add vegetables | Med. Lo to Med. – cook to desired doneness | Same as for Standard Burners |
| Stir Fry | HI – heat oil, add vegetables | Med. Hi to HI – finish cooking | Same as for Standard Burners |

*We recommend that these foods be stirred occasionally.

USING THE GRILL

A VENTILATING HOOD of adequate cubic-feet-per-minute capacity vented to the outside of the house is recommended for installation **ABOVE THE RANGE AND GRILL**. For most kitchens with a wall mounted hood, a certified hood rating of not less than 940 CFM is recommended. The hood must be installed according to installation instructions furnished with the hood and local building code requirements.

THE GRILL

(Available on some models)

When cooking food on the grill you will achieve the same flavor as meat cooked on an outdoor barbecue.

This flavor is actually created by the fats and juices that are brought to the surface of the food and caramelized by the intense heat from the stainless steel radiant.

Most types of foods, steaks, chops, patties, poultry pieces, etc., cook somewhat faster on the gas grill with its constant regulated heat than on an ordinary charcoal grill.

Your new Thermador Professional® grill is equipped with an aluminized steel double U-shaped tube burner typical of those used in restaurants. Automatic ignition is used to eliminate the continuous pilots found on restaurant grills. The grill burner is rated at 18,000 BTU/HR.

NOTE: When used with propane gas, a slight pop or flash may occur at the burner ports a few seconds after the burner has been turned off. This usually occurs after the burner has been on awhile. This is normal.

AUTOMATIC REIGNITION

The electronic igniter automatically sparks the burner to light. **DO NOT TOUCH** any burner while the igniters are sparking.

BURNER EFFICIENCY AND FLAME CHARACTERISTICS

The burner flame should be blue in color and stable with no yellow tips, excessive noise or lifting. It should burn completely along both sides of the burner tube.

An improper gas-air mixture may cause either a yellow tipped flame or burner flutter. Have the flame adjusted by a technician. Foreign particles in the gas line may cause an orange flame during initial use. This will disappear with use.

If the flame is uneven, flutters, makes excessive noise or lifts, check to see if the BURNER ports are clogged. If the ports are clogged, use a wire, a straightened paper clip or needle to clear the ports. If the condition persists, contact a service agency for adjustment.

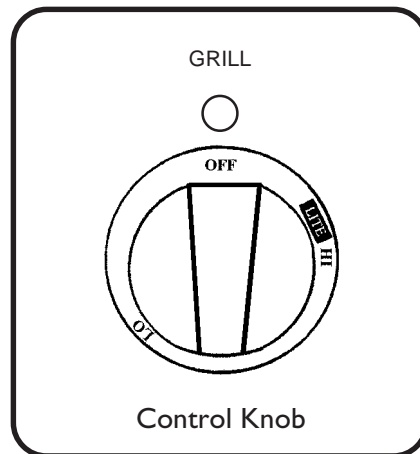

CONTROL KNOB

The burner control has an infinite number of heat settings, and there are no fixed positions on the control knob between HI and LO. To turn the burner on, press the control knob and rotate it counterclockwise to the LITE position.

Adjust the knob to the desired heat setting.

USING THE GRILL



CAUTION:

- Use extreme care when placing the grill components into the grill compartment. Avoid contacting the ceramic igniter which could break preventing operation of the grill.
- The grill must be assembled as shown. The drip tray heat shields must be in place, and the burner must be properly positioned relative to the gas supply. Incorrect assembly of the grill may result in unsafe or hazardous conditions during operation.
- Do not leave the grill unattended while in use.
- Do not use charcoal briquettes or coals of any kind.

After removing all packaging materials, check to be certain that the grill components are correctly assembled in the grill box. The grill grates, stainless steel radiant and the burner are assembled in the grill box from the factory. Follow the steps below to assemble the components in the grill box.

- A. Disassemble and/or remove the grill grate, stainless steel radiant and burner from the grill box.
- B. Install the aluminum rectangular drip pan inside the grill box as shown below.
- C. Install the heat deflector on grease drip pan handle and pins in front of the box.
- D. Insert the end of the burner into the slots at the back of the grill box. Insert the tab on front of the burner into slot in the heat deflector.
- E. The stainless steel radiant lies on two (2) studs on each end of the grill can.
- F. Place the grill grate, with raised food containment rail oriented towards the grill box rear.

Exploded Views and Side View of Grill

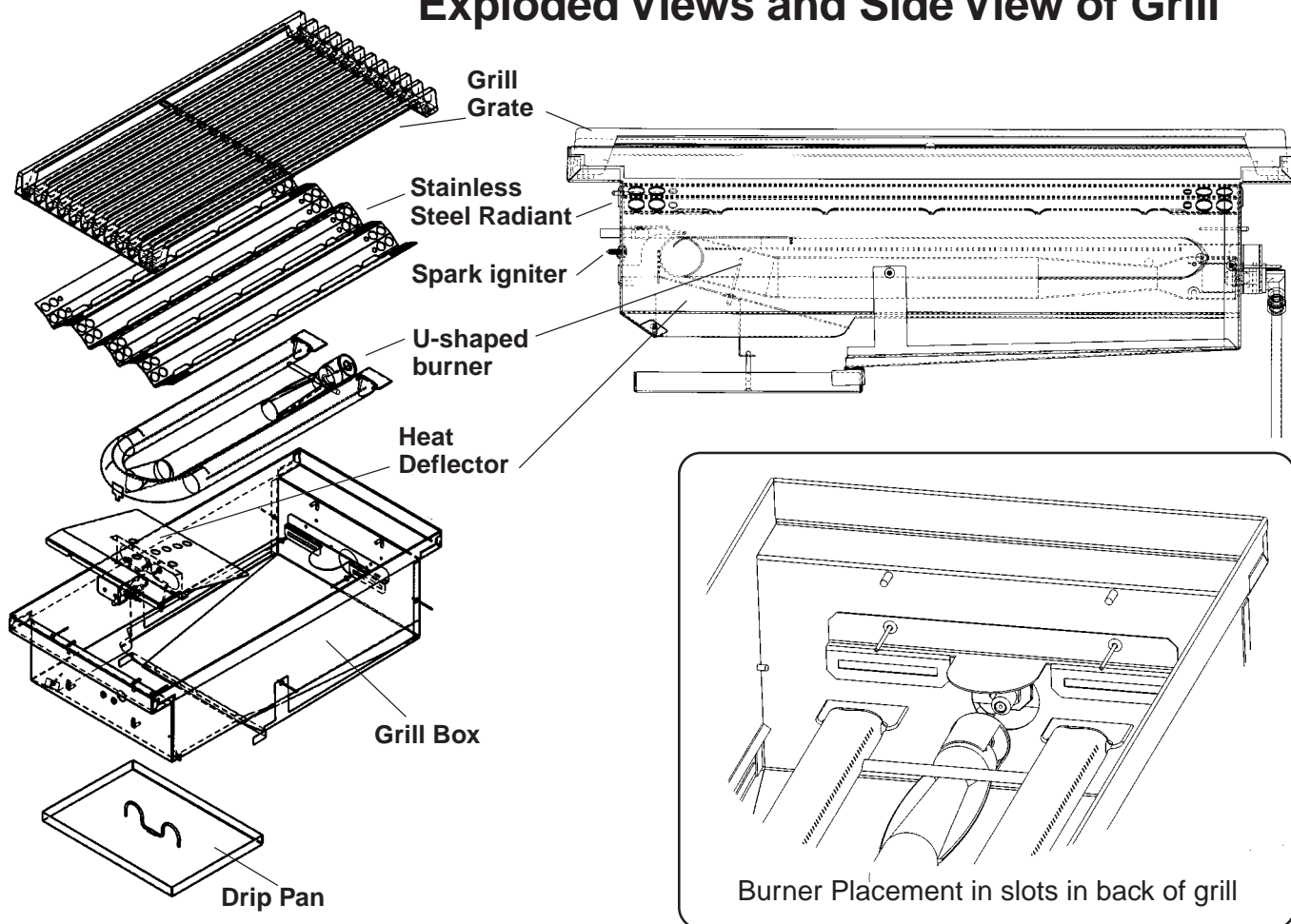

USING THE GRILL

COOKING ON THE GRILL

- The burner should light within approximately 5 seconds.
- Preheat grill for 10 to 15 minutes minimum. The hot grill sears the food, sealing in the juices. The longer the preheat, the faster the meat browns and the darker the brand marks.
- Grilling requires high heat for searing and proper browning. Most foods are cooked at the higher heat settings for most of the cooking time. However, when grilling large pieces of meat or poultry, it may be necessary to turn the heat to a lower setting after the initial browning. This cooks the food through without burning the outside.
- Foods cooked for a long time or basted with a sugary marinade many need a lower heat setting near the end of the cooking time.
- After grilling and the food has been removed, turn the knob to HI and burn off any excess grease which has accumulated on the stainless steel radiant.
- Use a brass wire brush, dipped in hot water, to loosen food particles from the grate.
- When the grill has cooled, clean the drip tray, radiant, heat deflector and compartment. Wipe the U-shaped burner with a damp cloth.

GRILLING SUGGESTIONS

- ◆ Trim any excess fat from the meat before cooking. Cut slits in the remaining fat around the edges at 2" (51 mm) intervals.
- ◆ Brush on basting sauce toward the end of cooking.
- ◆ Use a spatula or tongs instead of a fork to turn the meat. A fork punctures the meat and lets the juices run out.
- ◆ Add seasoning or salt after grilling.
- ◆ The grill grate has side and rear rails designed to make it easier to turn with a spatula.
- ◆ After the juices begin to bubble to the surface, turn the meat only once. This helps keep the juices in the meat.
- ◆ Some pieces of meat and poultry cook faster than others. Move those pieces to the cooler area of the grill until the rest have finished.
- ◆ The doneness of meat is affected by the thickness of the cut. Chefs say it is impossible to have a rare doneness with a thin cut.
- ◆ Do not leave the grill unattended while cooking.

HANDLING EXCESSIVE FLARE-UPS

- ◆ The intense heat needed for grilling may also cause flare-ups due to grease dripping on the stainless steel radiant.
- ◆ If flare-ups occur, use a long handled spatula to move the food to another area of the grill.
- ◆ Should flare-ups become excessive, remove the food from the grill and turn off the burner.
- ◆ Excessive flames occur when cooking meat with extra fat, i.e. 30% ground beef, untrimmed steaks, lamb chops, etc.
- ◆ Be cautious when turning meat over.
- ◆ It is important that grilling be supervised at all times.

Section Four: Using the Cooktop

GRILL COOKING CHART

| Food | Weight or Thickness | Control Setting | Total Suggested Cooking Time | Special Instructions and Tips | |
|---|---|------------------|------------------------------|---|---|
| MEATS Beef Hamburgers | 1/2 to 3/4 inch (13 mm to 19 mm) | Medium | 14 to 18 minutes | Grill, turning once when juices rise to the surface. Do not leave hamburgers unattended since a flare up can occur quickly. | |
| | | High | 12 to 15 minutes | | |
| | Steaks Rib, Club, Tenderloin, Porterhouse, T-Bone, Sirloin | 1" (25 mm) | High | | 10 to 14 minutes |
| | | | High | | 13 to 18 minutes |
| | | 1" (25 mm) | Medium to High | | 14 to 22 minutes |
| | | | High | | 18 to 27 minutes |
| | | 1" (25 mm) | Medium | | 22 to 32 minutes |
| 1-1/2" (38 mm) | Medium | 27 to 37 minutes | | | |
| Lamb Chops & Steaks | 1" (25 mm) | High | 12 to 15 minutes | Remove excess fat from edge. Slash remaining fat at 2-inch (51 mm) intervals. Grill, turning once. | |
| | | High | 14 to 18 minutes | | |
| | 1" (25 mm) | Medium to High | 15 to 20 minutes | | |
| | | High | 18 to 25 minutes | | |
| | 1" (25 mm) | Medium | 20 to 30 minutes | | |
| Pork Chops | 1/2" (13 mm) | Medium | 20 to 40 minutes | Remove excess fat from edge. Slash remaining fat at 2-inch (51 mm) intervals. Grill, turning once. Cook well done. | |
| | 1" (25 mm) | Medium | 35 to 60 minutes | | |
| | Ribs | Medium | 45 to 60 minutes | | Grill, turning occasionally. During last few minutes brush with barbecue sauce, turn several times. |

Chart continued, please see next page

Section Four: Using the Cooktop

GRILL COOKING CHART

| Food | Weight or Thickness | Control Setting | Total Suggested Cooking Time | Special Instructions and Tips |
|---|--|---|---|--|
| <p>MEATS Pork Ham Steaks (precooked)</p> <p>Hot Dogs</p> | <p>1/2 inch</p> | <p>High</p> <p>Medium</p> | <p>4 to 8 minutes</p> <p>5 to 10 minutes</p> | <p>Remove excess fat from edge. Slash remaining fat at 2-inch (51 mm) intervals. Grill, turning once.</p> <p>Slit skin. Grill, turning once.</p> |
| <p>POULTRY Chicken Broiler/Flyer Halved or Quartered</p> <p>Breasts</p> | <p>2 to 3 pounds</p> | <p>Low or Medium</p> <p>Medium</p> | <p>1 to 1-1/2 hours 40 to 60 minutes</p> <p>30 to 45 minutes</p> | <p>Place skin side up. Grill, turning 2 to 3 times.</p> |
| <p>FISH AND SEAFOOD Steaks Halibut, Salmon, Swordfish</p> <p>Whole Catfish, Rainbow Trout</p> | <p>3/4 to 1 inch</p> <p>8 to 16 ounces</p> | <p>Medium to High</p> <p>Medium to High</p> | <p>8 to 15 minutes</p> <p>20 to 30 minutes</p> | <p>Grill, turning once. Brush with melted butter, margarine or oil to keep moist.</p> <p>Grill, turning once. Brush with melted butter, margarine or oil to moisten.</p> |

ABOUT THE GRIDDLE

(Available on some models)

DESCRIPTION

The built in griddle is made of restaurant quality aluminum coated with titanium. This produces a surface with even heat that is easy to clean.

The griddle has an aluminized steel tube burner that is lit by a spark igniter. The griddle should light within 4 clicks of the igniter. This eliminates the need for a continuous burning pilot lighter.

A maple chopping block is available as an accessory and purchased separately. It is sized to fit on top of the surface when the griddle is not being used.

- The burner is rated at 15,000 BTU / HR.

CONTROL KNOB

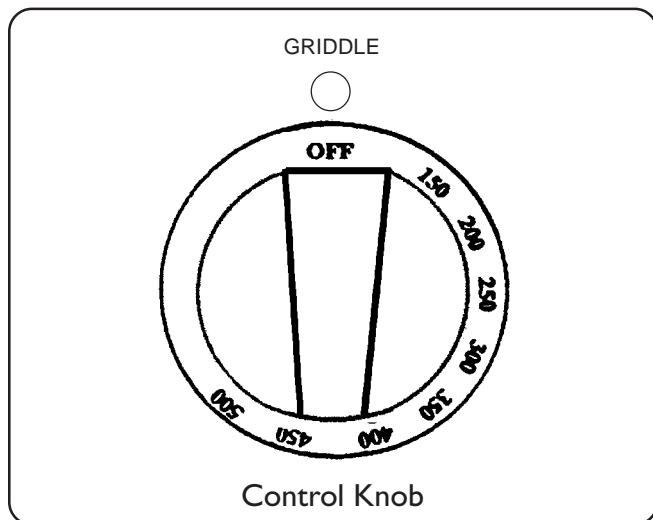

- The griddle is electronically controlled with temperatures marked on the knob from 150°F to 500°F.
- There are no fixed settings on the knob.
- Press and turn the knob counter-clockwise to the temperature setting.

PREPARING THE GRIDDLE

The griddle must be level or tilted slightly forward for optimum performance. The griddle should have been leveled during installation. If not, the griddle can be leveled by removing the griddle plate and frame then adjusting the leveling screws at the front and back of the griddle opening.

The griddle plate should be washed with warm soapy water then rinsed with clear water prior to use. The griddle may be used without any butter, margarine or oil. However, a very small amount may be used to flavor foods.

Any utensil, including metal ones may be used on the griddle surface. Care should be taken so the surface is not gouged when metal utensils are used.

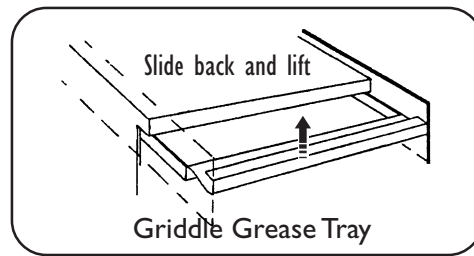

Griddle Grease Tray

- Push the tray under the front edge of the griddle overhang to catch grease or food residue.
- Use a metal spatula to scrape the grease and food particles forward from the surface into the tray.
- Clean the tray after every use. When removing the tray, use care when tipping it so that the contents do not spill.

Cooking on the Griddle

1. Check that the grease tray is tucked under the griddle plate overhang.
2. Turn the knob to the cooking temperature to preheat the griddle.
3. Preheat 10 to 15 minutes.
4. Add butter, margarine, oil or shortening for more flavor.
5. Add the food and cook.

GRIDDLE COOKING CHART

| FOOD | SETTING |
|------------------------|---------------------------------|
| Bacon, Ham, Pork Chops | 350°F to 375°F (177°C to 190°C) |
| Eggs | 300°F to 325°F (150°C to 160°C) |
| Pancakes, French Toast | 350°F to 375°F (177°C to 191°C) |
| Potatoes, Hash Brown | 400°F to 425°F (205°C to 219°C) |
| Sandwiches, Sausage | 350°F to 375°F (177°C to 191°C) |

ABOUT THE WOK

(Available on models PSC484WK and P24WK)

A ventilating hood of adequate CFM capacity vented to the outside of the house is recommended for installation above this cooktop or wok. For most kitchens with a wall mounted hood, a certified hood rating of not less than 940 CFM is recommended. The hood must be installed according to installation instructions furnished with the hood and local building code requirements.

DESCRIPTION

Your new Thermador Professional Wok, has a heavy cast iron burner typical of those used in restaurants.

BTU Output for the Wok Burner

- HI is equivalent to 30,000 BTU/HR.
- LO is equivalent to 10,000 BTU/HR.

Pilot Light Igniter

The igniter will spark and ignite the pilot light.

- The pilot light will be on for about 45 seconds to 1 minute, then the safety valve opens and the burner lights.

FLAME DESCRIPTION

- The burner flame color should be blue with no yellow on the tips. It is not uncommon to see orange in the flame; this indicates the burning of airborne impurities in the gas and will disappear with use.
- The flame should burn completely along both sides of the burner tube.
- If the flame is uneven, flutters, makes excessive noise or lifts, check to see if the burner ports are clogged. Use a straightened paper clip wire or needle to open the ports if they are clogged. Never use a toothpick; it could break off in the port.
- Contact an authorized service technician if an inefficient flame persists.
- When used with propane gas (LP), a slight pop may be heard a few seconds after the burner is turned off. This is normal and usually occurs after the wok has been on for awhile.

CONTROL KNOB

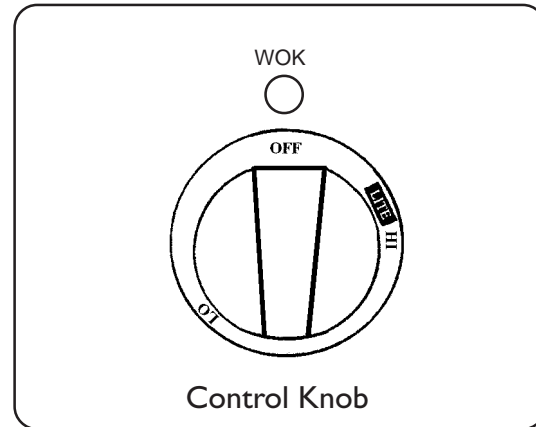

- There are no fixed positions on the knob between HI and LO.
- Press and turn the knob counter-clockwise to the LITE position.
- An audible click will be heard as the igniter lights the pilot light.
- When the burner ignites, adjust the knob to the heat setting.

PREPARING THE WOK PAN

1. The first time the wok pan is used, clean the surface with hot soapy water to remove the protective oil coating. Dry thoroughly.
2. Apply a light coat of vegetable oil with a paper towel to the entire surface, inside and out.
Do not use corn or olive oil.
3. Heat the pan on a medium setting until the surface turns golden brown, about 20 seconds. Cool. Wipe off excess oil.
4. Repeat this procedure several times to seal the pores of the metal. This prevents the steel from rusting and keeps the food from sticking.
5. Wipe off excess oil before using again or storing. Do not scour seasoned surface; scouring removes the protection.

WOK OPERATION

WOK ASSEMBLY

1. Remove all packaging materials and temporary labels from the wok pan.
2. Make sure that the plastic ties used for shipping have been removed.

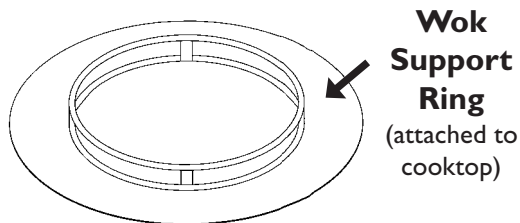
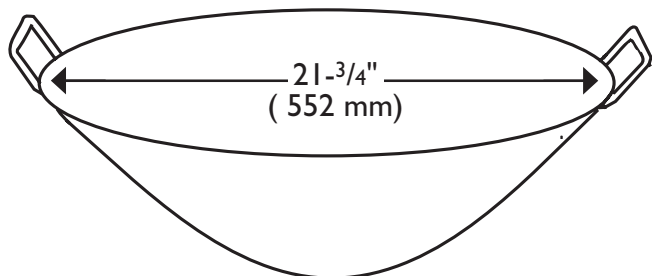

3. Check that the support ring is properly placed above the burner.
4. Place wok pan into support ring before turning on the burner.
5. Turn the control knob to the LITE position. After 45 to 60 seconds, turn to the heat setting.
6. It is normal for the wok pan to discolor and darken with use. This indicates that it is well seasoned.

Wok Trivet

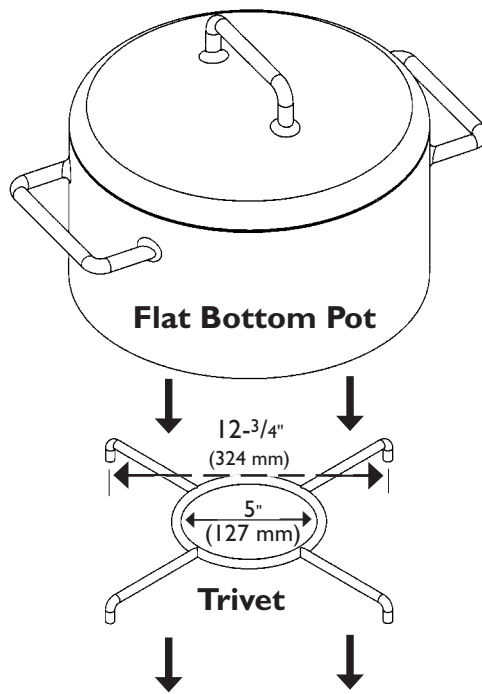

- Use the trivet to support a flat-bottom wok or a large stock pot.
- Assemble as shown in the drawing above.

CARE AND MAINTENANCE



CAUTION

Avoid cleaning any part of the cooktop while it is hot. Do not clean any removable part of the cooktop in a self-cleaning oven.

ABOUT THIS CHART

- Always start by selecting the mildest cleaner according to the kind of soil and the material soiled. To prevent marring the stainless steel finish, always apply the cleaners in the direction of the polish lines. Rinse and dry immediately to avoid water marks.

- Use clean applicators, i.e. soft cloths, sponges, paper towels, soap-filled pads, for cleaning and scouring.
- The use of brand names in the chart is intended only to indicate a type of cleaner. This does not constitute an endorsement. The omission of any brand name cleaner does not imply its inadequacy.
- The brands listed on the chart are suggested as examples of a type of cleaner, such as non-abrasive, mild abrasive, powder, creme, etc. Use all products in accordance with the manufacturer's instructions.

COOKTOP CLEANING CHART

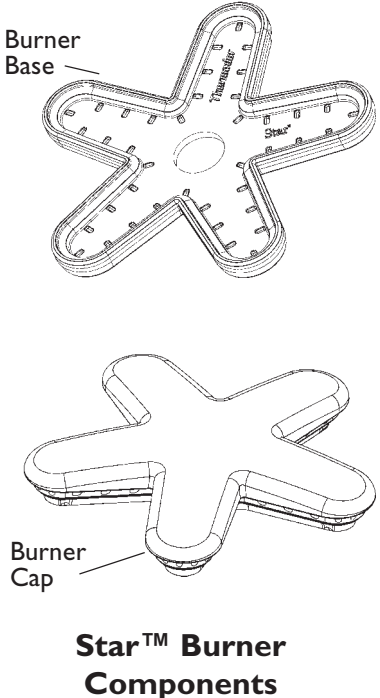
| Cooktop Part / Material | Suggested Cleaners | Important Reminders |
|--|---|---|
| <p>Burner Base and Cap and Spill Tray/ Stainless Steel</p>  <p>Star™ Burner Components</p> | <ul style="list-style-type: none"> • Hot sudsy water; rinse and dry thoroughly. • Mild Abrasive Cleansers: Bon Ami®, Ajax®, Comet®. Liquid cleaners: Kleen King®. • Stiff nylon bristle tooth brush to clean port openings. • Reassemble as shown. Make sure that the burner cap is seated on the base. | <ul style="list-style-type: none"> • Acidic and sugar-laden spills deteriorate the stainless steel. Remove soil immediately. • Do not scratch or gouge the port openings of burner cap. |
| <p>Control Knobs/Plastic Bezels/Chrome</p> | <ul style="list-style-type: none"> • Hot sudsy water; rinse and dry immediately. | <ul style="list-style-type: none"> • Do not soak knobs. • Do not force knobs onto wrong valve shaft. |

COOKTOP CLEANING CHART

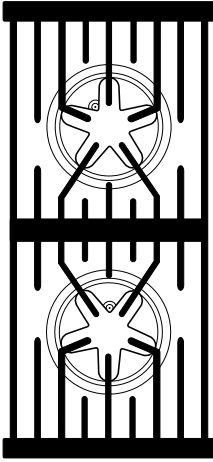
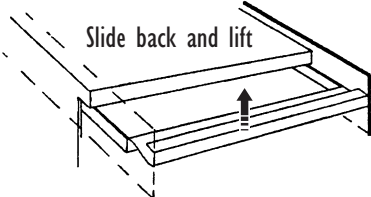
| Cooktop Part / Material | Suggested Cleaners | Important Reminders |
|---|---|---|
| <p>Exterior Finish/Stainless Steel</p> | <ul style="list-style-type: none"> • Nonabrasive Cleaners: Hot water and detergent, ammonia, Fantastic® Formula 409®. Rinse and dry immediately. • Cleaner Polish: Stainless Steel Magic® to protect the finish from staining and pitting; enhances appearance. • Hard water spots: Household vinegar. • Mild Abrasive Cleaners: Siege Stainless Steel and Aluminum Cleaner, Kleen King® Stainless Steel liquid cleaner. • Heat discoloration: Cameo®, Barkeepers Friend®, Zud®. | <ul style="list-style-type: none"> • Stainless steel resists most food stains and pit marks providing the surface is kept clean and protected. • Never allow food stains or salt to remain on stainless steel for any length of time. • Rub lightly in the direction of polish lines. • Chlorine or chlorine compounds in some cleaners are corrosive to stainless steel. Check ingredients on label. |
| <p>Grates:/Porcelain Enamel on Cast Iron</p>  | <ul style="list-style-type: none"> • Nonabrasive cleaners: Hot water and detergent, Fantastic®, Formula 409®. Rinse and dry immediately. • Mild abrasive cleaners: Bon Ami® and Soft Scrub®. • Abrasive cleaners for stubborn stains: soap-filled steel wool pad. | <ul style="list-style-type: none"> • The grates are heavy; use care when lifting. Place on a protected surface. • Blisters/ crazing/ chips are common due to the extreme temperatures on grate fingers and rapid temperature changes. • Acidic and sugar-laden spills deteriorate the enamel. Remove soil immediately. • Abrasive cleaners, used too vigorously or too often can eventually mar the enamel. |
| <p>Griddle Grease Tray/ Titanium Coated Aluminum</p>  | <ul style="list-style-type: none"> • Clean the grease tray after each use. • May be placed in dishwasher. • Wash in detergent and hot water; rinse and dry. • Stubborn soil: Soft Scrub® | <ul style="list-style-type: none"> • Empty grease tray after each use. • Remove tray after grease has cooled. Be careful not to fill it so full that tipping to remove it spills the grease. |

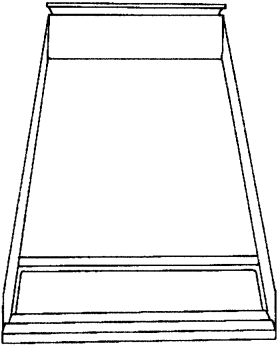
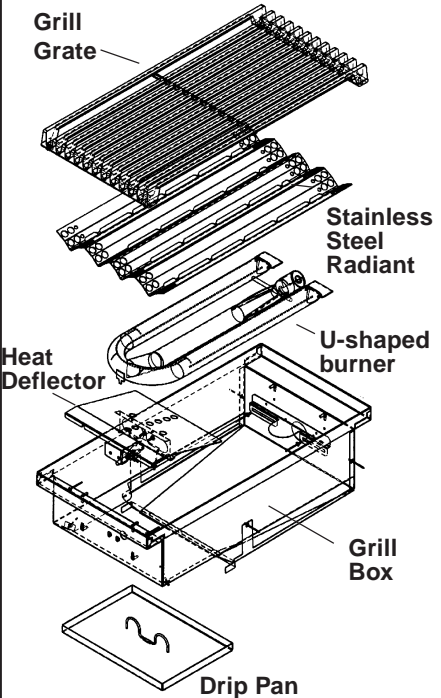

COOKTOP CLEANING CHART, continued

| Cooktop Part / Material | Suggested Cleaners | Important Reminders |
|--|--|---|
| <p>Griddle/Titanium coated aluminum</p>  | <ul style="list-style-type: none"> Remove drip tray and discard grease into a grease resistant container for disposal. Wash drip tray in warm soapy water or place in dishwasher. Wipe griddle surface with warm soapy water then rinse with warm water. Wipe dry with a soft cloth. If food particles stick to the griddle plate, remove with a mild abrasive cleaner such as Soft Scrub®. | <ul style="list-style-type: none"> Never flood a hot griddle with cold water. This can warp or crack the aluminum plate. Do not clean any part of the griddle in a self-cleaning oven. |
| <p>Grill Box/Stainless Steel</p>  | <ul style="list-style-type: none"> Non-abrasive Cleaners: Hot water and detergent, ammonia, Fantastic®, Formula 409®. Rinse and dry immediately. Mild Abrasive Cleaners: Bon Ami® Soft Scrub®. Abrasive cleaners for stubborn stains: soap-filled steel wool pad, Kleen King® Stainless Steel liquid cleaner. <div data-bbox="570 1608 1414 1696" style="border: 1px solid black; padding: 5px;"> <p>Note: To reach the grill box, remove the grate, stainless steel radiant, U-shaped burner, heat shield and drip pan.</p> </div> | <ul style="list-style-type: none"> Do not clean any part of the grill assembly in a self-cleaning oven. Abrasive cleaners, used too vigorously or too often, will eventually scratch the steel. When disassembling, cleaning and reassembling the grill, avoid contact with the spark igniter. |

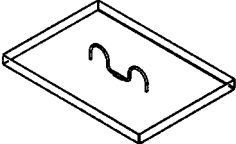
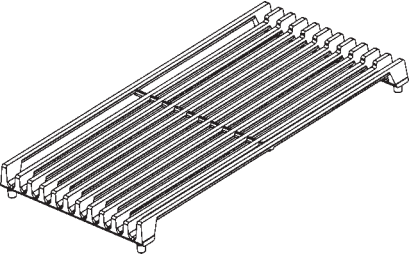
COOKTOP CLEANING CHART, continued

| Cooktop Part / Material | Suggested Cleaners | Important Reminders |
|---|--|---|
| <p>Grill Drip Pan / Stainless Steel</p>  | <ul style="list-style-type: none"> • Hot sudsy water; rinse and dry thoroughly. • After grease removal, drip pan may be put into dishwasher. | <ul style="list-style-type: none"> • Do not clean in a self-cleaning oven. |
| <p>Grill Grate/Porcelain Enamel on Cast Iron</p>  | <ul style="list-style-type: none"> • While the grate is hot (but the flame is off), dip a brass grill brush in hot water and scrub the grate. The steam created from the hot water and the abrasive action of the brush helps loosen the hard to remove soil. | <ul style="list-style-type: none"> • The grate is heavy; use care when lifting. Place on a protected surface. • Blisters, crazing and chips are common due to the extreme temperatures and rapid temperature changes. |
| <p>Igniters/Ceramic</p> | <ul style="list-style-type: none"> • Use a cotton swab dampened with water, Formula 409® or Fantastic®. | <ul style="list-style-type: none"> • Do not use sharp tool to scrape the igniter. It is fragile; if it is damaged the grill cannot be lit. |
| <p>Surface Spill Trays/ Stainless Steel</p> | <ul style="list-style-type: none"> • Hot sudsy water; rinse and dry thoroughly. • Formula 409® or Fantastic®. Wipe spray off immediately or apply to a paper towel first and then wipe spill. • Mild Abrasive Cleansers: Cameo®, Zud®, Barkeepers Friend®. Liquid cleaners: Kleen King®, Siege Stainless Steel and Aluminum Cleaner. Apply with care. | <ul style="list-style-type: none"> • Acidic and sugar-laden spills deteriorate the stainless steel. Remove soil immediately. • Abrasive cleaners, used too vigorously or too often, can eventually mar the stainless steel. |

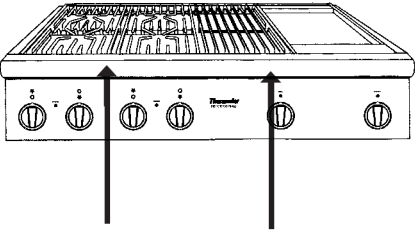
COOKTOP CLEANING CHART, continued

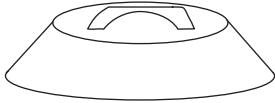
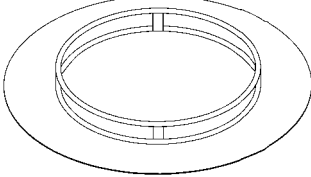
| Cooktop Part / Material | Suggested Cleaners | Important Reminders |
|---|--|---|
| <p>Surface Trim Strips</p>  <p>Trim Strips (Located between stainless steel spill trays; they join the spill trays.)</p> | <ul style="list-style-type: none"> • Hot sudsy water; rinse and dry thoroughly. • Formula 409® or Fantastic®. Wipe spray off immediately or apply to a paper towel first and then wipe soil. | <ul style="list-style-type: none"> • The over-spray from liquid cleaners may leave an outline shadow. If allowed to dry, it may leave a permanent outline. |
| <p>Wok Burner / Cast Iron</p> | <ul style="list-style-type: none"> • Clear ports of any soil with a straightened wire paper clip or needle. • Scour burner with S.O.S®, Scotch Brite® pad, or powdered cleanser. Rinse and dry well. Drain and dry venturi tube before replacing burner. | <ul style="list-style-type: none"> • Do not use a toothpick to clear ports. It can break off and plug the opening. • Do not hit the igniter or pilot when replacing burner. |
| <p>Wok Pan, 24" / Steel</p>  | <ul style="list-style-type: none"> • Wash after each use with hot, soapy water. Rinse and dry. • Do not use harsh abrasives or scouring pads without re-seasoning the pan. • Keep both the inside and outside of the pan seasoned with oil as described on Page 22. | <ul style="list-style-type: none"> • The wok pan is steel and will rust if not seasoned. |
| <p>Wok Pan Cover / Aluminum</p>  | <ul style="list-style-type: none"> • Wash with hot, soapy water. Rinse and dry immediately. | |
| <p>Wok Support Ring Stainless Steel</p>  | <ul style="list-style-type: none"> • Wash after each use with hot, soapy water. • Rinse with hot water and clean sponge. | <ul style="list-style-type: none"> • It is normal for stainless steel to discolor due to high temperatures. |

DO-IT-YOURSELF MAINTENANCE

POWER FAILURE

In the event of a power failure, only the standard (non-ExtraLow®) burners and grill can be lighted manually. It is necessary to light each standard burner individually.

If the cooktop is being used when the power failure occurs, turn all of the burner control knobs to the OFF position. Then, the standard

burners and grill can be lighted by holding a match at the ports and turning the control knob to the HI position. Wait until the flame is burning all the way around the burner cap before adjusting the flame to the desired height.

The two ExtraLow® burners on the far left side cannot be used

during a power failure. Be sure to turn them OFF if a power failure occurs. They will not turn back on until both control knobs are first turned OFF and then turned back on again. The griddle and wok cannot be used during a power failure. See **What To Do If You Smell Gas**, inside front cover.

INTERMITTENT OR CONSTANT IGNITER SPARKING

Intermittent or constant sparking of the sealed gas surface burners can result from a number of preventable conditions. Eliminate these conditions as indicated in the chart.

| <u>SYMPTOM</u> | <u>CAUSE</u> | <u>REMEDY</u> |
|---|--|---|
| Intermittent sparking (Wok) | <ul style="list-style-type: none"> • Improper fit of burner cap into burner base • Ceramic igniter is wet or dirty. • Burner ports are clogged. • Knob is left in the LITE position | <ul style="list-style-type: none"> • Seat cap in place. • Carefully dry or clean igniter. • Clean ports in burner cap with a wire, a needle or straightened paper clip. • Turn Wok knob to a setting between HI and LO. |
| Constant Sparking | <ul style="list-style-type: none"> • Cooktop is not properly grounded. • Electrical power supply is incorrectly polarized. | <ul style="list-style-type: none"> • Have a qualified electrician ground the cooktop properly. Refer to Installation Instructions. • Refer to Installation Instructions for correct installation. |

BEFORE CALLING FOR SERVICE

Before calling for service, check the following to avoid unnecessary service charges.

Be sure to check these items first:

- Is there a power outage in the area?
- Is the household fuse blown or the circuit breaker tripped?
- Is the Cooktop disconnected from the electrical supply?

IF THE BURNERS DO NOT IGNITE

- Are the burner caps properly aligned on the burner bases (Sealed Surface Burners)?
- Are the burner ports clogged?
- Is a fuse blown or is the circuit breaker tripped?
- Is the manual shut-off valve closed, preventing the flow of gas?
- Are the Wok pilot ports clogged?
- Is the spark igniter sparking (Surface Burners and Wok)?
- Is there flame on the Wok pilot burner?

DATA RATING PLATE

Cooktop Models:

The data rating plate shows the model and serial numbers of your Cooktop or Wok. It is located on the underside of the Cooktop or Wok chassis near the gas inlet connection and electric power cord. In most cases after installation, technicians are unable to access the information.

Product Rating Label Location – Cooktop Model

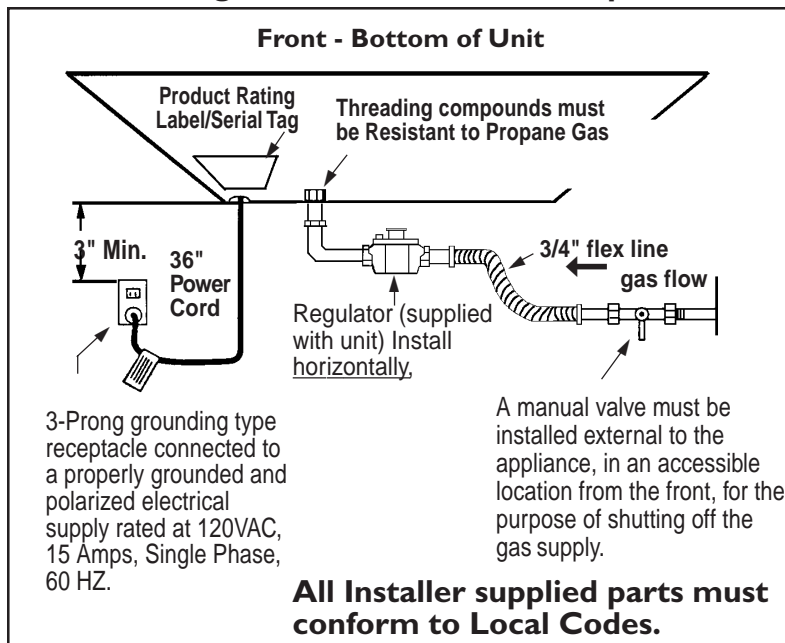

WOK MODEL:

The data rating plate shows the model and serial numbers of your Wok. It is located on the bottom of the unit.

CUSTOMER SERVICE:

800/735-4328

or see our website:
www.thermador.com

SERVICE INFORMATION

Serial Number

Date of Purchase

Dealer's Name

Dealer's Phone Number

Service Center's Name

Service Center's Phone Number

Also, enter this information on the Product Registration Form included with this product, then mail it to the indicated address.

— Thank You.

NOTES

NOTES

WARRANTY

Full One Year Warranty

Covers one year from the date of installation or date of occupancy for a new previously unoccupied dwelling, Save your dated receipt or other evidence of the installation/occupancy date.

Thermador® Will Pay For:

All repair labor and replacement parts found to be defective due to materials and workmanship.

Service must be provided by a Factory Authorized Service Agency during normal working hours.

For a Service Agency nearest you, please dial 800/735-4328.

Thermador® Will Not Pay For:

1. Service by an unauthorized agency. Damage or repairs due to service by an unauthorized agency or use of unauthorized parts.
2. Service visits to:
 - Teach you how to use the appliance.
 - Correct the installation. You are responsible for providing electrical wiring and other connecting facilities.
 - Reset circuit breakers or replace home fuses.
3. Damage caused from accident, alteration, misuse, abuse, improper installation or installation not in accordance with local electrical codes or plumbing codes, or improper storage of the appliance.
4. Repairs due to other than normal home use.
5. Service labor during limited warranty period.
6. Travel fees and associated charges incurred when the product is installed in a location with limited or restricted access (i.e., airplane flights, ferry charges, isolated geographic regions).

Warranty applies to appliances used in residential application: it does not cover their use in commercial installations.

This warranty is for products purchased and retained in the 50 states of the U.S.A., the District of Columbia and Canada. Should the appliance be sold by the original purchaser during the warranty period, the new owner continues to be protected until the expiration date of the original purchaser's warranty period.

The warranty applies even if you should move. **Thermador does not assume any responsibility for incidental or consequential damages.** Some states do not allow the exclusion or limitation of incidental or consequential damages, so the above limitation or exclusion may not apply to you. This warranty gives you specific legal rights and you may also have other rights which may vary from state to state or province to province.

Specifications are for planning purposes only. Refer to installation instructions and consult your countertop supplier prior to making counter opening. Consult with a heating and ventilating engineer for your specific ventilation requirements. For the most detailed information, refer to installation instructions accompanying product or write Thermador indicating the model number.

Thermador reserves the right to change specifications or design without notice. Some models are certified for use in Canada. Thermador is not responsible for products which are transported from the United States for use in Canada. Check with your local Canadian distributor or dealer. Thermador, 5551 McFadden Avenue, Huntington Beach, CA 92649.

For the most up to date critical installation dimensions by fax, use your fax handset and dial 702/833-3600. Use code #8030.



Thermador®

5551 McFadden Avenue, Huntington Beach, CA 92649 • 800/735-4328
RO 8608-A • 5040002713 • © 2002 BSH Home Appliances Corp. • Litho U. S. A. 1/02