

SAMSUNG

Installation and Operating Instructions
Ceramic Glass Hob



C61RCCN / C61RCAST / C61RCBAL / C61RCDST

To avoid the risk of accidents or damage to the hob, read all instructions before installing or using the appliance. Keep this manual for future reference.

Contents

Using This Manual	2
Safety	3
Electrical safety	3
Child safety	3
Safety during use	4
Safety when cleaning	4
Disposal Instructions	4
Installing the Hob	5
Regulations and compliance	5
Safety instructions for the installer	5
Connecting to the mains power supply	6
Installing into the countertop	7
Parts and Features	10
Cooking zones and control panel	10
Components	11
The key features of your appliance	12
Safety shutoff	13
Residual heat indicator	13
Before You Begin	14
Initial cleaning	14
Hob Use	14
Using suitable cookware	14
Using the touch control sensors	15
Switching the appliance on	16
Temperature control	16
Switching the appliance off	17
Using the casserole cooking zone	18
Using the double cooking zone	19
Switching a cooking zone off	20
Using the child safety lock	20
Timer	21
Setting the safety shutoff	21
Countdown timer	22
Locking and unlocking the control panel	23
Suggested settings for cooking specific foods	23
Cleaning and Care	24
Hob	24
Hob Frame (C61RCAST, C61RCBAL, C61RCDST)	25
To avoid damaging your appliance	25
Warranty and Service	26
FAQs and troubleshooting	26
Service	27
Technical Data	28

Using This Manual

EN

Please take the time to read this owner's manual, paying particular attention to the safety information contained in the following section, before using your appliance. Keep this manual for future reference. If transferring ownership of the appliance, please remember to pass the manual on to the new owner.

The following symbols are used in the text



This is the safety alert symbol.

Warning indicates information concerning your personal safety.

Important indicates information on avoiding damage to the appliance.



This symbol indicates useful information and practical tips.



This symbol refers to measures that can be taken to help protect the environment.

1. Numbers like these indicate step - by - step instructions for using the appliance.
2. ...
3. ...

This manual contains information on steps you can take yourself to diagnose and resolve problems that may arise. Refer to the section "Troubleshooting."

Safety



The safety aspects of this appliance comply with accepted technical standards and the German Appliance Safety Law. However, as manufacturers we also believe it is our responsibility to familiarise you with the following safety instructions.

EN

Electrical safety

- Be sure the appliance is properly installed and grounded by a qualified technician.
- The appliance should be serviced only by qualified service personnel. Repairs carried out by unqualified individuals may cause injury or serious malfunction. If your appliance is in need of repair, contact your local service centre. Failure to follow these instructions may result in damage and void the warranty.
- Flush - mounted appliances may be operated only after they have been installed in cabinets and workplaces that conform to the relevant standards. This ensures sufficient protection against contact for electrical units as required by the VDE [Association of German Electrical Engineers].
- If your appliance malfunctions or if fractures, cracks or splits appear:
 - switch off all cooking zones;
 - disconnect the hob from the mains supply; and
 - contact your local service centre.
- If the cooktop cracks, turn the appliance off to avoid the possibility of electric shock. Do not use your hob until the glass surface has been replaced.
- Do not use the hob to heat aluminium foil, products wrapped in aluminium foil or frozen foods packaged in aluminium cookware.

Child safety



This appliance is not intended for use by young children or infirm persons without the adequate supervision of a responsible adult.

Young children should be supervised to ensure that they do not play with the appliance.

The cooking zones will become hot when you cook. Always keep small children away from the appliance.

Safety (continued)

EN

Safety during use

- This appliance is to be used only for normal cooking and frying in the home. It is not designed for commercial or industrial use.
- Never use the hob for heating the room.
- Take care when plugging electrical appliances into mains sockets near the hob. Mains leads must not come into contact with the cooktop.
- Overheated fat and oil can catch fire quickly. Never leave surface units unattended when preparing foods in fat or oil, for example, when cooking chips.
- Turn the cooking zones off after use.
- Always keep the control panels clean and dry.
- Never place combustible items on the hob, it may cause fire.

Safety when cleaning

- Always turn the appliance off before cleaning.
- For safety reasons do not clean the appliance with a steam jet or high - pressure cleaner.
- Clean the hob in accordance with the cleaning and care instructions contained in this manual.

Disposal Instructions

Disposing of the packaging material

- All materials used to package the appliance are fully recyclable. Sheet and hard foam parts are appropriately marked. Please dispose of packaging materials and old appliances with due regard to safety and the environment.

Proper disposal of your old appliance



Warning: Before disposing of your old appliance, make it inoperable so that it cannot be a source of danger.

To do this, have a qualified technician disconnect the appliance from the mains supply and remove the mains lead.

- The appliance may not be disposed of in the household rubbish.
- Information about collection dates and public refuse disposal sites is available from your local refuse department or council.

Installing the Hob



Important: Be sure the new appliance is installed and grounded only by qualified personnel.

Please observe this instruction. The warranty will not cover any damage that may occur as a result of improper installation.

Technical data is provided at the end of this manual.

EN

Regulations and compliance

This appliance meets the following standards:

- EN 60 335 - 1 and EN 60 335 - 2 - 6, relating to the safety of electrical appliances for household use and similar purposes;
- EN 60350, or DIN 44546 / 44547 / 44548, relating to the operating features of electric cookers, hobs, ovens, and grills for household use;
- EN 55014 - 2;
- EN 55014;
- EN 61000 - 3 - 2; and
- EN 61000 - 3 - 3, relating to basic requirements for electromagnetic compatibility (EMC).



This appliance complies with the following EU Directives:

- 73 / 23 / EWG dated 19.02.1973 (Low Voltage Directive);
- 89 / 336 / EWG dated 03.05.1989 (EMC Directive including Amending Directive 92 / 31 / EWG); and
- 93 / 68 / EWG CE Labeling Directive.

Safety instructions for the installer

- A device must be provided in the electrical installation that allows the appliance to be disconnected from the mains at all poles with a contact opening width of at least 3 mm. Suitable isolation devices include line protecting cut - outs, fuses (screw type fuses are to be removed from the holder), earth leakage trips and contactors.
- With respect to fire protection, this appliance corresponds to EN 60 335 - 2 - 6. This type of appliance may be installed with a high cupboard or wall on one side.
- Drawers may not be fitted underneath the hob.
- The installation must guarantee shock protection.
- The kitchen unit in which the appliance is fitted must satisfy the stability requirements of DIN 68930.
- For protection against moisture, all cut surfaces are to be sealed with a suitable sealant.
- On tiled work surfaces, the joints in the area where the hob sits must be completely filled with grout.
- On natural, artificial stone, or ceramic tops, the snap action springs must be bonded in place with a suitable artificial resin or mixed adhesive.
- Ensure that the seal is correctly seated against the work surface without any gaps. Additional silicon sealant must not be applied; this would make removal more difficult when servicing.
- The hob must be pressed out from below when removed.

Installing the Hob (Continued)

EN

Connecting to the mains power supply

Before connecting, check that the nominal voltage of the appliance, that is, the voltage stated on the rating plate, corresponds to the available supply voltage. The rating plate is located on the lower casing of the hob.

Shut off power to circuit before connecting wires to circuit.

The heating element voltage is AC230 V~. The appliance also works perfectly on older networks with AC220 V~.

The hob is to be connected to the mains using a device that allows the appliance to be disconnected from the mains at all poles with a contact opening width of at least 3 mm, eg. automatic line protecting cut - out, earth leakage trips or fuse.

A type H05SS - F (180°C) cable or one of a higher grade must be used as the mains connecting cable.

	Rated current of appliance (A)	Nominal cross-sectional area (mm ²)
1N~	> 25 and ≤ 32	> 4 and < 6
2N~	> 10 and ≤ 16	> 1.5 and < 2.5

The connection must be carried out as shown in the diagram. The connecting links should be fitted according to the appropriate connection diagram.

The earth lead is connected to terminal. The earth lead must be longer than leads carrying electric current.

The cable connections must be made in accordance with regulations and the terminal screws tightened securely.

The connecting cable is to be secured with the mains cable cleat and the covering closed by pressing firmly (locking into place). Before switching on for the first time, any protective foil or stickers must be removed from the ceramic glass surface.



Once the hob is connected to the mains supply, check that all cooking zones are ready for use by briefly switching each on in turn at the maximum setting.



When the hob is powered on for the first time, all displays light and the child safety lock is activated.

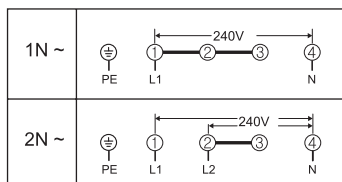

< IN ~ >

L: Brown

N: Blue

PE: Green



Warning: Pay attention (conformity) to phase and neutral allocation of house connection and appliance (connection schemes); otherwise, components can be damaged.

Warranty does not cover damage resulting from improper installation.

Installing the Hob (Continued)

EN



Make a note of the serial number on the appliance rating plate prior to installation. This number will be required in the case of requests for service and is no longer accessible after installation, as it is on the original rating plate on the underside of the appliance.

Pay special attention to the minimum space and clearance requirements.

Secure the brackets at both sides with the provided screws before mounting the hob onto the brackets.

When installing this cook top, a board shall be fitted which will limit access to the cook top base enclosure

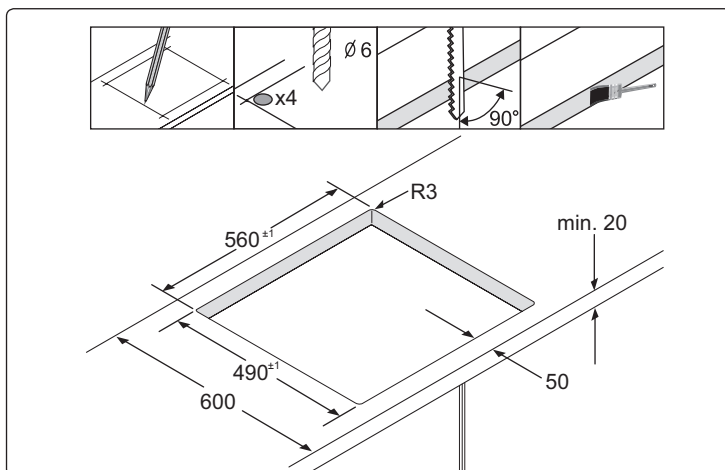
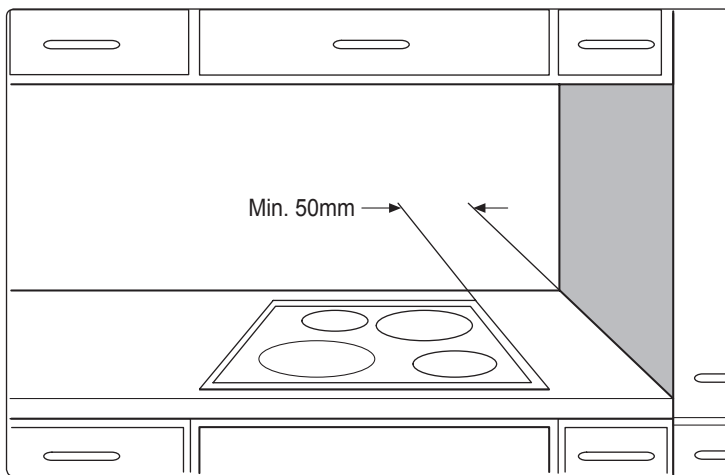

Installing the Hob (Continued)

Model : C61RCBAL, C61RCCN, C61RCDST

EN

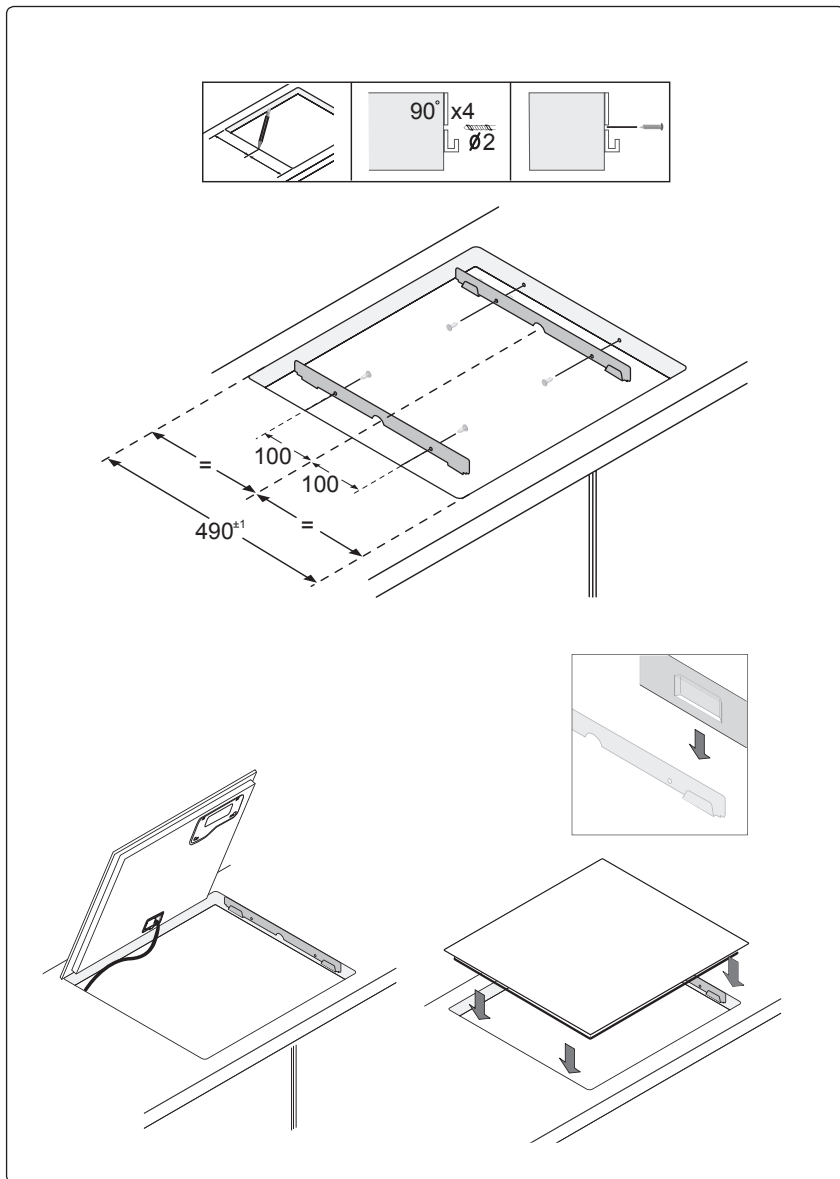

Installing the Hob (Continued)

Model : C61RCAST

EN

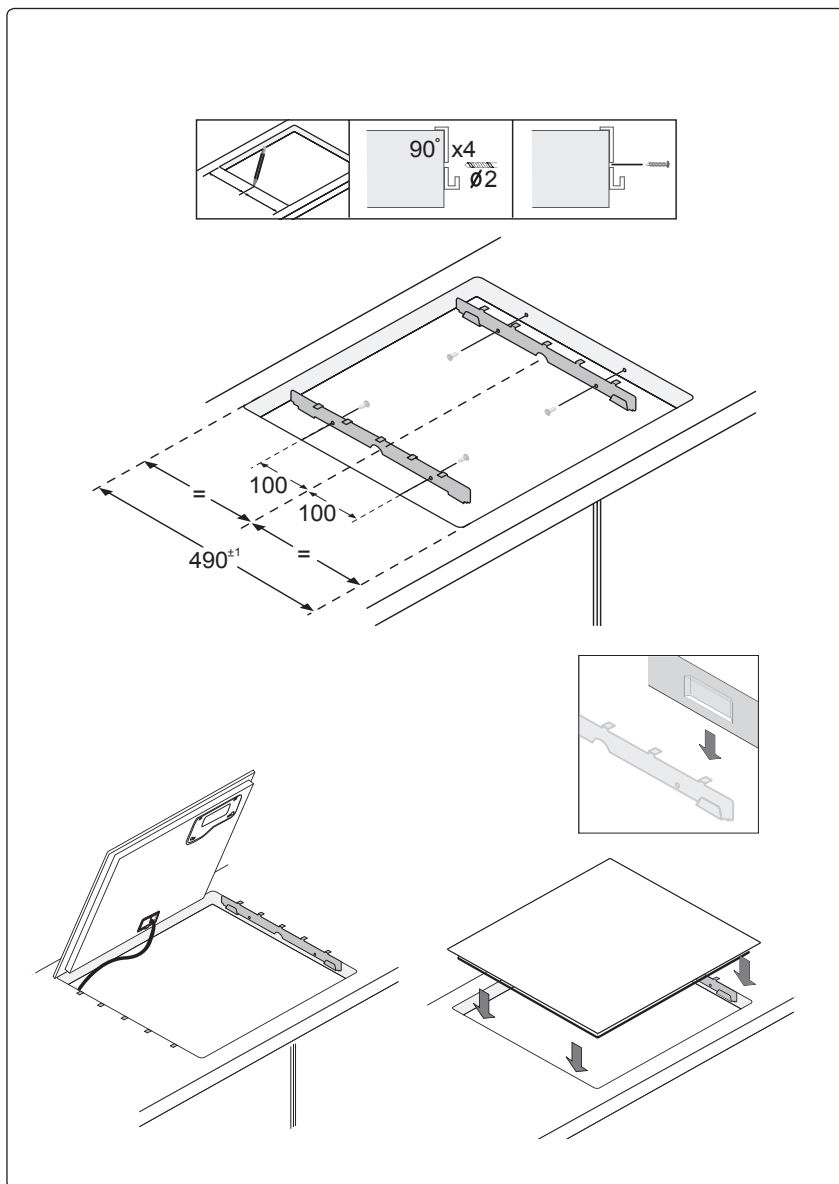

Parts and Features

EN

Cooking zones and control panel

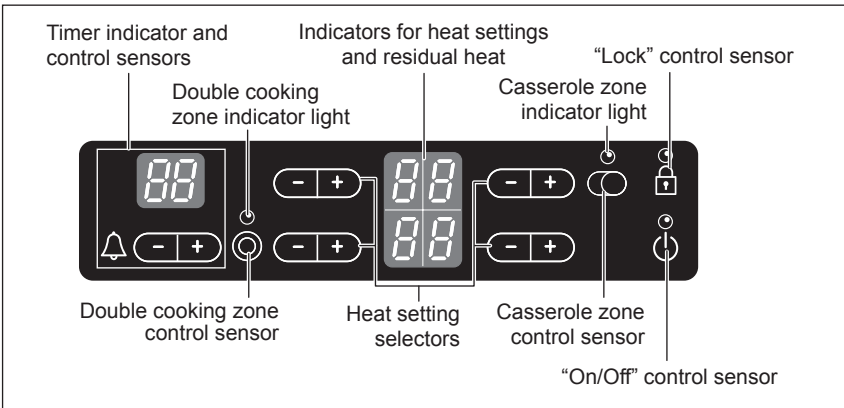
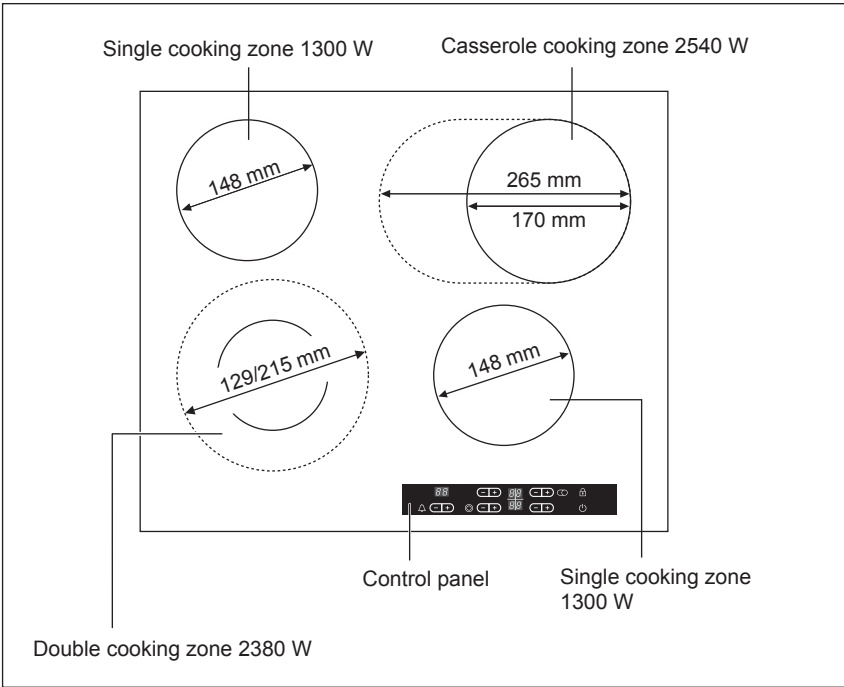

Parts and Features (Continued)

Components

EN

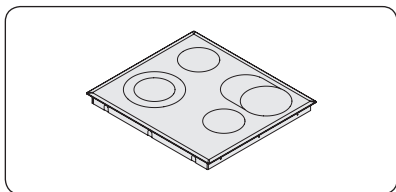

1 Ceramic Glass Hob

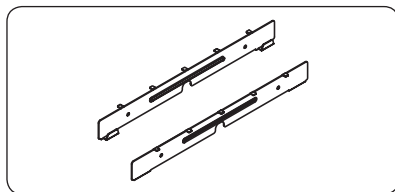

2 Installation Brackets

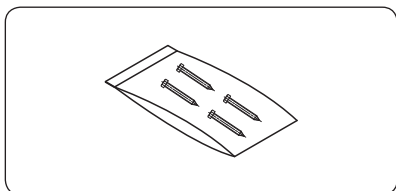

3 Screws

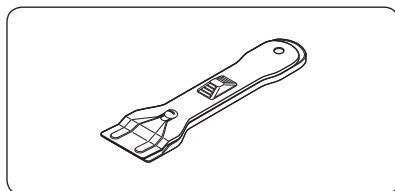

4 Scraper

Parts and Features (Continued)









EN

The key features of your appliance

- **Ceramic glass cooking surface:** The appliance has a ceramic glass cooking surface and four rapid - response cooking zones. The hob's powerful radiant heater elements significantly shorten the amount of time required for the zones to heat up.
- **Touch control sensors:** Your appliance is operated using touch control sensors.
- **Easy cleaning:** The advantage of the ceramic glass cooking surface and the control sensors is their accessibility for cleaning. The smooth, flat surface is easy to clean.
- **On / Off sensor:** The "On / Off" control sensor provides the appliance with a separate mains switch. Touching this sensor switches the power supply on or off completely.
- **Control and function indicators:** Digital displays and indicator lights provide information about settings and activated functions, as well as the presence of residual heat in the various cooking zones.
- **Safety shutoff:** A safety shutoff ensures that all cooking zones switch off automatically after a period of time if the setting has not been changed.
- **Residual heat indicator:** An icon for residual heat appears in the display if the cooking zone is so hot that there is a risk of burning.
- **Double cooking zone:** The cooking surface features a double cooking zone. This provides the appliance with a cooking zone of variable size, for instance, for when cooking with smaller cookware. This allows savings in energy.
- **Multipurpose cooking zone:** The hob is equipped with a multipurpose / casserole cooking zone. Depending on the setting, it can be used as a round or oval cooking zone, for example, for when cooking with oval casseroles or for keeping dishes or food warm.

Digital displays: The four display fields are assigned to the four cooking zones.

They show the following information:

-  the appliance has been switched on,
-  to  selected heat settings,
-  residual heat,
-  the child lock is activated; and
-   error message, the sensor has been touched for longer than 10 seconds.
-   error message, when the Hob is overheated because of abnormal operation.

Parts and Features (Continued)

EN



Safety shutoff

If one of the cooking zones is not switched off or the heat setting is not adjusted after an extended period of time, that particular cooking zone will automatically switch itself off. Any residual warmth will be indicated with  (for "hot") in the digital displays corresponding to the particular cooking zones.

The cooking zones switch themselves off at the following times.

Cooking setting	1 - 2	After 6 hours
Cooking setting	3 - 4	After 5 hours
Cooking setting	5 - 6	After 3 hours
Cooking setting	7 - 9	After 1 hour



If the Hob is overheated because of abnormal operation,   will be displayed. And the Hob will be switched off.



Should one or more of the cooking zones switch off before the indicated time has elapsed, see the section "Troubleshooting."

Other reasons why a cooking zone will switch itself off

All cooking zones will immediately switch themselves off if liquid boils over and lands on the control panel.

The automatic shutoff will also be activated if you place a damp cloth on the control panel. In both of these instances, the appliance will need to be switched on again using the main power sensor after the liquid or the cloth has been removed .

Residual heat indicator

When an individual cooking zone or the hob is turned off, the presence of residual heat is shown with an  (for "hot") in the digital display of the appropriate cooking zones. Even after the cooking zone has been switched off, the residual heat indicator goes out only after the cooking zone has cooled.

You can use the residual heat for thawing or keeping food warm.



Important: As long as the residual heat indicator is illuminated, there is a risk of burns.

Important: If the power supply is interrupted, the  symbol will go out and information about residual heat will no longer be available. However, it may still be possible to burn yourself. This can be avoided by always taking care when near the hob.

Before You Begin

EN

Initial cleaning

Wipe the ceramic glass surface with a damp cloth and ceramic cooktop glass cleaner.



Important: Do not use caustic or abrasive cleaners. The surface could be damaged.

Hob Use

Using suitable cookware

Better pans produce better results.

- You can recognise good pans by their bases. The base should be as thick and flat as possible.
- When buying new pans, pay particular attention to the diameter of the base. Manufacturers often give only the diameter of the upper rim.
- Pots with aluminium or copper bases can cause metallic discolouration on the ceramic glass surface. The discolouration is very difficult or impossible to remove.
- Do not use pans made of cast iron or which have damaged bases with rough edges or burrs. Permanent scratching can occur if these pan are slid across the surface.
- When cold, pan bases are normally bowed slightly inwards (concave). They should never be bowed outwards (convex).
- If you wish to use a special type of pan, for example, a pressure cooker, a simmering pan, or a wok, please observe the manufacturer's instructions.

Energy saving tips



You can save valuable energy by observing the following points.



Right!

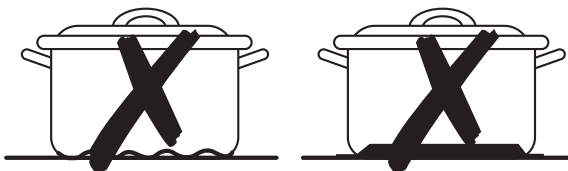

Wrong!

Hob Use (Continued)

EN

- Always position pots and pans before switching on the cooking zone.
- Dirty cooking zones and pan bases increase power consumption.
- When possible, position the lids firmly on the pots and pans to cover completely.
- Switch the cooking zones off before the end of the cooking time to use the residual heat for keeping foods warm or for thawing.

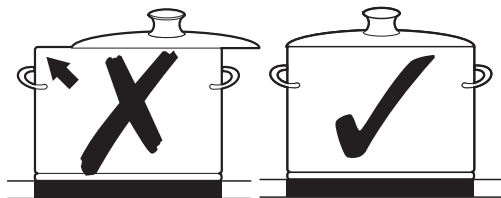

- The base of the pan should be the same size as the cooking zone.
- Using a pressure cooker reduces cooking times by up to 50 %

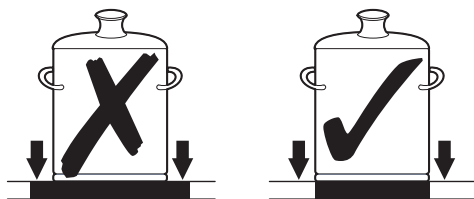

Using the touch control sensors

To operate the touch control sensors, touch the desired panel with the tip of your pointed finger until the relevant displays illuminate or go out, or until the desired function is activated.

Ensure that you are touching only one sensor panel when operating the appliance. If your finger is too flat on the panel, an adjacent sensor may be actuated as well.

Hob Use (Continued)

EN

Switching the appliance on

Touch the "Lock " sensor for approximately 3 seconds.

The appliance is switched on using the "On / Off " control sensor.

Touch the "On / Off " sensor.

The digital displays will show .



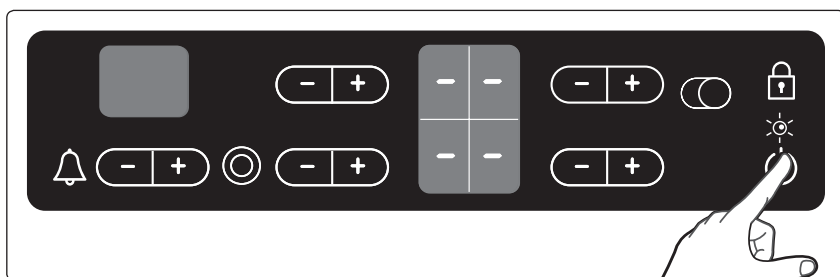

After the "On / Off " sensor has been actuated to switch on your appliance, a heat setting must be selected within approximately 10 seconds. Otherwise, the appliance will switch itself off for safety reasons.





Temperature control

For setting and adjusting the power level ( to ) for cooking, touch the corresponding cooking zone's ,  keys.

The first time  is pressed, the heat level is set to .

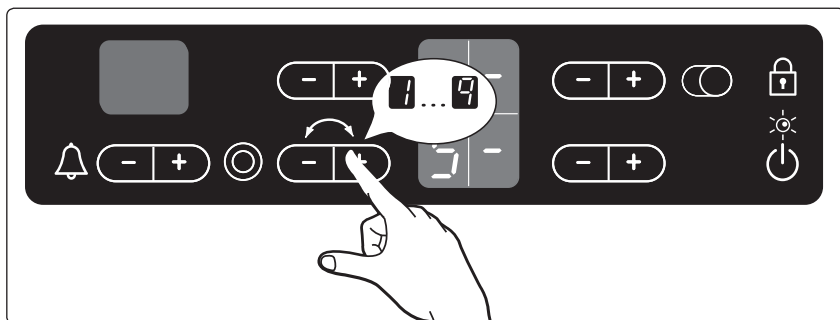

The first time  is pressed, the heat level is set to .

Use the  key to increase the heat setting and the  key to decrease.



Hob Use (Continued)

Switching the appliance off

To completely switch off the appliance, use the "On / Off " control sensor. Touch the "On / Off  sensor.



After switching off a single cooking zone or the entire cooking surface, the presence of residual heat will be indicated in the digital displays of the corresponding cooking zones in the form of an  (for "hot").

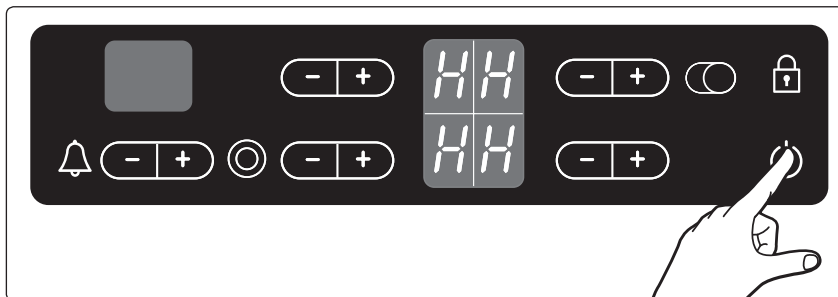

Hob Use (Continued)

EN



If the heat setting is at and **4** you want to turn the **+** burner off, the sensor can be touched one additional time, and the heat setting will go to zero.

For faster adjustment, keep your finger on the **+** or **-** sensor until the required value is obtained.

If more than one sensor is pressed for longer than 10 seconds, **5** **5** will show in the heat setting display. To reset, touch the “On / Off **⏻**” sensor.

Using the casserole cooking zone

By using the casserole cooking zone, you can switch from the smaller cooking zone to the larger oval cooking zone.



You can switch between the two zone settings only if a heat level has already been set for the smaller zone.

1. Select a heat setting.

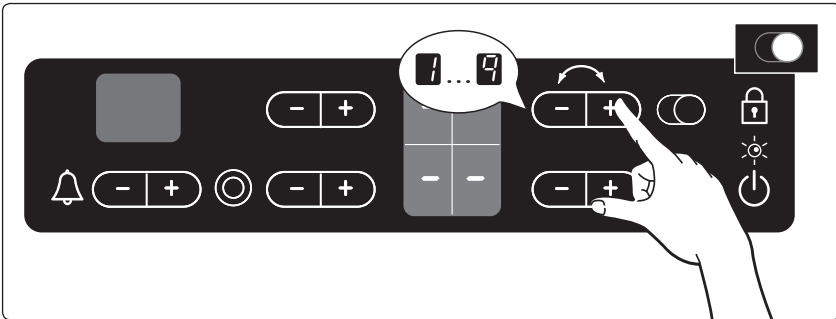

2. To switch the casserole cooking zone on or off, place your finger flat on the “Casserole cooking zone” touch sensor until the indicator light illuminates or extinguishes.

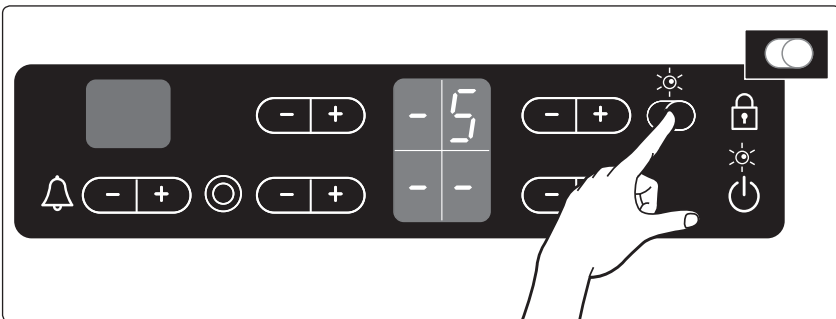

Hob Use (Continued)

EN

Using the double cooking zone

By using the double cooking zone, you can alternate between the smaller cooking zone and the larger cooking zone depending on the size of the cookware you are using. Select the setting with the “Double Cooking Zone ©” control sensor.

 You can switch between the two cooking zones only after a heat setting has been selected for the smaller cooking zone.

1. Select the desired heat setting.

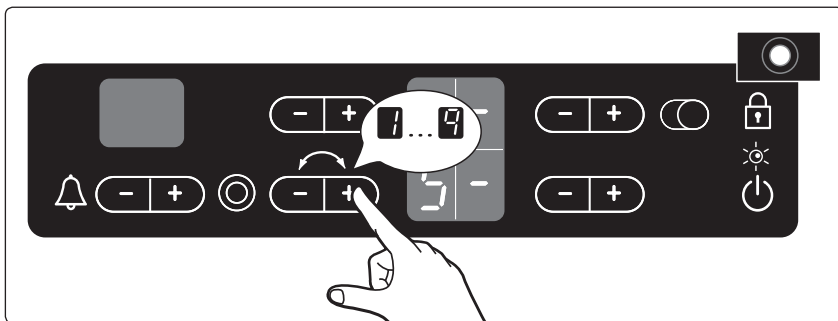

2. Touch the “Double Cooking Zone ©” control sensor.
This will switch on the outer cooking zone.
The indicator light will illuminate.

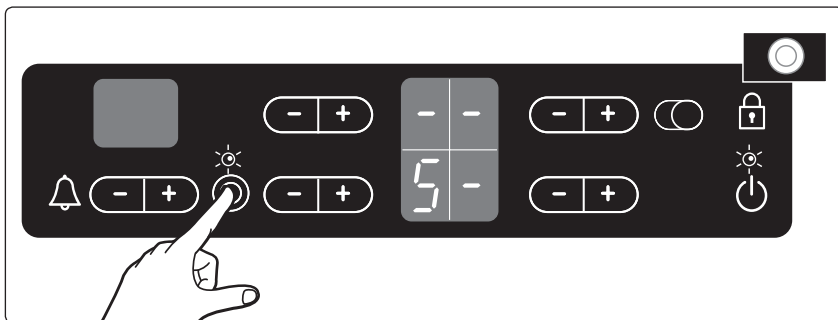

3. To switch the outer cooking zone off, touch the “Double Cooking Zone ©” control sensor.

Hob Use (Continued)

EN

Switching a cooking zone off

To switch off a cooking zone, return the setting to **0** by using the control panel's heat setting and touch sensors **[-]** or **[+]**.

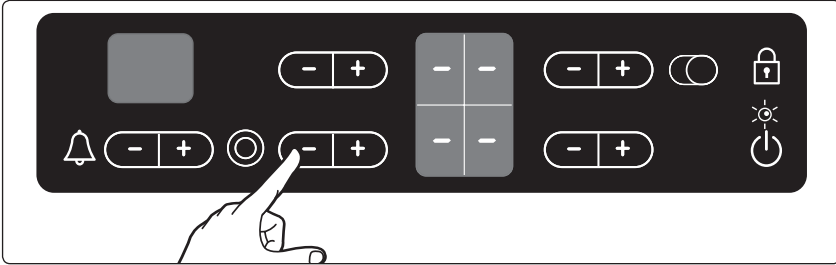



Using the child safety lock

You can use the child safety lock to safeguard against unintentionally turning on a cooking zone and activating the cooking surface. The lock control sensor can be used only when the power is on.

Switching the child safety lock on

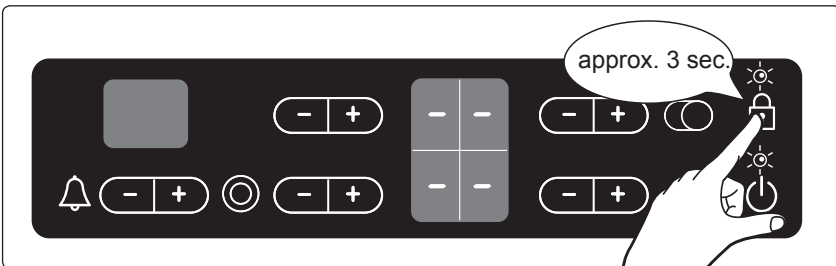
1. Touch the  control sensor for approximately 3 seconds.
An acoustic signal will sound as confirmation.



2. Touch any heat setting control sensor .
 will appear in the displays, indicating the child safety lock has been activated.

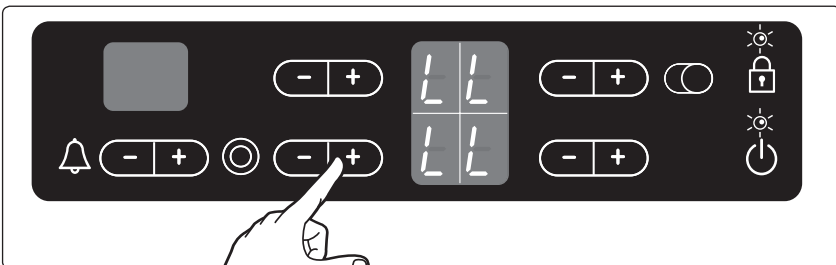

Hob Use (Continued)

EN

Switching the child safety lock off

1. Touch the control sensor for approximately 3 seconds.
An acoustic signal will sound as confirmation.

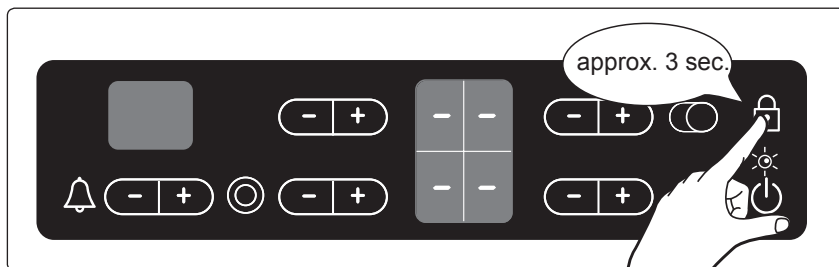

Timer

There are two ways to use the timer:

Using the timer as a safety shutoff



If a specific time is set for a cooking zone, the cooking zone will shut itself off once this period of time has elapsed. This function can be used for multiple cooking zones simultaneously.

Using the timer to count down

The countdown timer cannot be used if a cooking zone has been switched on.

Setting the safety shutoff

The cooking zone(s) for which you want to apply the safety shutoff must be switched on.

1. Using the timer's control sensor , select the cooking zone for which the safety shutoff time is to be set.
After the first active cooking zone is selected, touching the timer's control sensor  will cause the corresponding indicator to flash slowly.
For example, the front left indicator corresponds to the front left cooking zone.  will appear in the timer display.

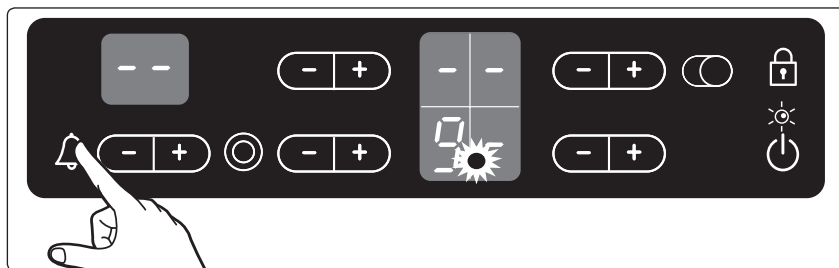

The next active cooking zone is selected by touching the timer's control sensor again .

Hob Use (Continued)

EN

2. Use the $\boxed{+}$ or $\boxed{-}$ timer setting control sensors to set the desired amount of time, for example, 15 minutes, after which the cooking zone will automatically switch itself off. The safety shutoff is now activated.

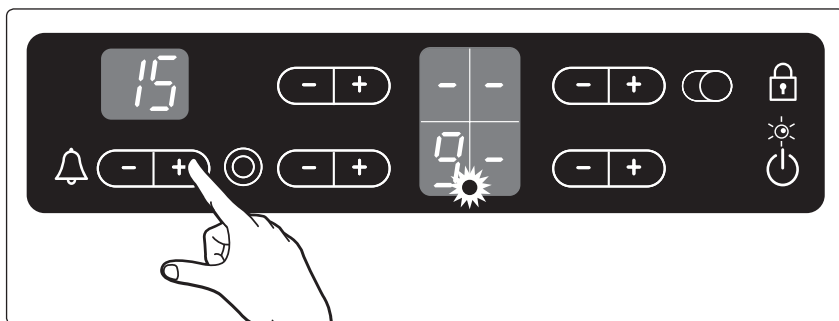

To display the time remaining for any of the cooking zones, use the timer's control sensor \triangle . The corresponding control indicator will begin to blink slowly.

The settings are reset using the $\boxed{+}$ or $\boxed{-}$ timer setting control sensors. After the set period of time has elapsed, the cooking zone automatically switches itself off, an acoustic signal sounds as confirmation and the timer display indicates .



To make the settings more quickly, touch any of the $\boxed{+}$ or $\boxed{-}$ timer setting control sensors until the desired value is reached.

If the $\boxed{-}$ timer setting control sensor is touched first, the time setting will begin at 99 minutes; if the $\boxed{+}$ timer setting control sensor is touched first, the time setting will begin at 1 minute.

Countdown timer

For the countdown timer to be used, the appliance must be switched on but all the cooking zones must be switched off.

1. Touch the timer's control sensor \triangle .
 $\boxed{-}$ will appear in the timer display.
2. Set the desired period of time using the $\boxed{+}$ or $\boxed{-}$ timer setting control sensors. The countdown timer function is now activated and the remaining time appears in the timer display.
To adjust the remaining time, touch the timer's control sensor and change the setting using the $\boxed{+}$ or $\boxed{-}$ timer setting control sensors \triangle .

Hob Use (Continued)

EN

Locking and unlocking the control panel

At any stage during the cooking process, the control panel, with the exception of the “On / Off” control sensor, can be locked in order to prevent the settings from being changed unintentionally, for example, by wiping over the panel with a cloth.

1. Touch the lock control sensor for approximately 3 seconds.
The indicator light in the lock control sensor will illuminate. The control sensors are now locked.
2. To unlock the control sensor, touch the lock control sensor again for approximately 3 seconds. The indicator light in the lock control sensor will extinguish.

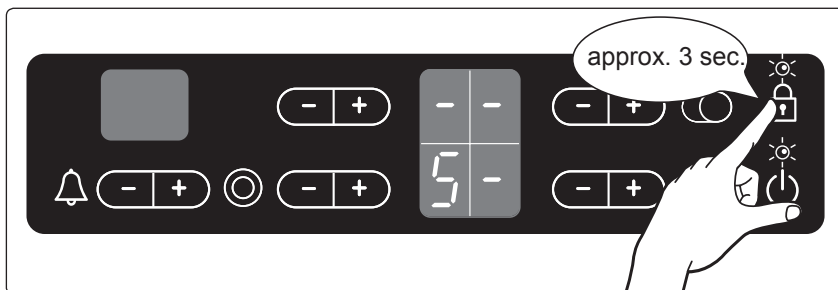

Suggested settings for cooking specific foods

The figures in the table below are guidelines. The heat settings required for various cooking methods depend on a number of variables, including the quality of the cookware being used and the type and amount of food being cooked.

Switch Setting	Cooking method	Examples for Use
9	Warming Sautéing Frying	Warming large amounts of liquid, boiling noodles, searing meat, (browning goulash, braising meat)
8	Intensive Frying	Steak, sirloin, hash browns, sausages, pancakes / griddle cakes
7		
6	Frying	Schnitzel / chops, liver, fish, rissoles, fried eggs
5	Boiling	Cooking up to 1.5 l liquid, potatoes, vegetables
4		
3	Steaming Stewing Boiling	Steaming and stewing of small amounts of vegetables, boiling rice and milk dishes
2		
1	Melting	Melting butter, dissolving gelatine, melting chocolate

Note

- The heat settings indicated in the table above are provided only as guidelines for your reference.
- You will need to adjust the heat settings according to specific cookware and foods.

Cleaning and Care

EN

Hob



Important: Cleaning agents must not come into contact with a heated ceramic glass surface: All cleaning agents must be removed with adequate amounts of clean water after cleaning because they can have a caustic effect when the surface becomes hot. Do not use any aggressive cleaners such as grill or oven sprays, scouring pads or abrasive pan cleaners.



Clean the ceramic glass surface after each use when it is still warm to the touch. This will prevent spillage from becoming burnt onto the surface. Remove scales, watermarks, fat drippings and metallic discolouration with the use of a commercially available ceramic glass or stainless steel cleaner.

Light Soiling

1. Wipe the ceramic glass surface with a damp cloth.
2. Rub dry with a clean cloth. Remnants of cleaning agent must not be left on the surface.
3. Thoroughly clean the entire ceramic glass cooking surface once a week with a commercially available ceramic glass or stainless steel cleaner.
4. Wipe the ceramic glass surface using adequate amounts of clean water and rub dry with a clean lint - free cloth.

Stubborn Soiling

1. To remove food that has boiled over and stubborn splashes, use a glass scraper.
2. Place the glass scraper at an angle to the ceramic glass surface.
3. Remove soiling by scraping with the blade.



Glass scrapers and ceramic glass cleaners are available from specialty retailers.

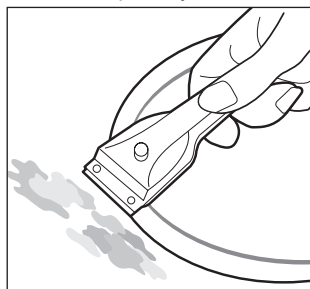

Cleaning and Care (Continued)

EN

Problem Dirt

1. Remove burnt-on sugar, melted plastic, aluminium foil or other materials with a glass scraper immediately and while still hot.



Important: There is a risk of burning yourself when the glass scraper is used on a hot cooking zone:

2. Clean the hob as normal when it has cooled down.



If the cooking zone on which something has melted has been allowed to cool, warm it up again for cleaning. Scratches or dark blemishes on the ceramic glass surface, caused, for example, by a pan with sharp edges, cannot be removed. However, they do not impair the function of the hob.

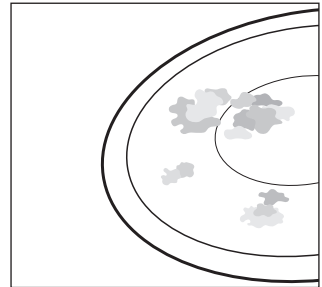

Hob Frame (C61RCAST, C61RCBAL, C61RCDST)



Important: Do not use vinegar, lemon juice or scale remover on the hob frame; otherwise dull blemishes will appear.

1. Wipe the frame with a damp cloth.
2. Moisten dried debris with a wet cloth. Wipe and rub dry.

To avoid damaging your appliance

- Do not use the cooktop as a work surface or for storage.
- Do not operate a cooking zone if there is no pan on the cooktop or if the pan is empty.
- Ceramic glass is very tough and resistant to temperature shock, but it is not unbreakable. It can be damaged by a particularly sharp or hard object dropping onto the cooktop.
- Do not use pans made of cast iron or which have damaged bases with rough edges or burrs. Scratching may occur if these pans are slid across the surface.
- Do not place pans on the hob frame. Scratching and damage to the finish may occur.
- Avoid spilling acidic liquids, for example, vinegar, lemon juice and descaling agents, onto the hob frame, since such liquids can cause dull spots.
- If sugar or a preparation containing sugar comes into contact with a hot cooking zone and melts, it should be cleaned off immediately with a kitchen scraper while it is still hot. If allowed to cool, it may damage the surface when removed.
- Keep all items and materials that could melt, for example, plastics, aluminium foil and oven foils, away from the ceramic glass surface. If something of this nature melts onto the cooktop, it must be removed immediately with a scraper.

Warranty and Service

EN

FAQs and troubleshooting

A fault may result from a minor error that you can correct yourself with the help of the following instructions. Do not attempt any further repairs if the following instructions do not help in each specific case.



Warning: Repairs to the appliance are to be performed only by a qualified service technician. Improperly effected repairs may result in considerable risk to the user. If your appliance needs repair, please contact your customer service centre.

What should I do if the cooking zones are not functioning?

Check for the following possibilities:

- The fuse in the house wiring (fuse box) is intact. If the fuses trip a number of times, call an authorised electrician.
- The appliance is properly switched on.
- The control indicators in the control panel are illuminated.
- The cooking zone is switched on.
- The cooking zones are set at the desired heat settings.

What should I do if the cooking zones will not switch on?

Check for the following possibilities:

- A period of more than 10 seconds has elapsed between when the On / Off button was actuated and the desired cooking zone switches on (see the section “Switching the appliance on”).
- The control panel is partially covered by a damp cloth or liquid.

What should I do if the display except for the residual warmth indicator suddenly disappears?

This could be a result of one of two possibilities:

- The On / Off sensor was accidentally actuated.
- The control panel is partially covered by a damp cloth or liquid.

What should I do if, after the cooking zones have been switched off, residual warmth is not indicated in the display?

Check for the following possibility:

- The cooking zone was only briefly used and therefore did not become hot enough. If the cooking zone is hot, please call the customer service centre.

What should I do if the cooking zone will not switch on or off?

This could be due to one of the following possibilities:

- The control panel is partially covered by a damp cloth or liquid.
- The child safety lock is on.

What should I do if the display is illuminated?

Check for the following:

- The control panel is partially covered by a damp cloth or liquid. To reset, press the “On / Off” control sensor.

Warranty and Service (Continued)

EN

What does it mean when the burner does not glow red?

- The selected temperature of the cooking zone is maintained by a sensor that cycles the zone on and off, so the surface cooking area will not always glow red. If you select a low heat setting, the heat will cycle on and off more frequently than at higher settings. The heat also cycles on and off at the highest setting.

If you request a service call because of an error made in operating the appliance, the visit from the customer service technician may incur a charge even during the warranty period.

Service

Before calling for assistance or service, please check the section “Troubleshooting.” If you still need help, follow the instructions below.

Is it a technical fault?

If so, please contact your customer service centre.

Always prepare in advance for the discussion. This will ease the process of diagnosing the problem and also make it easier to decide if a customer service visit is necessary.

Please take note of the following information.

- What form does the problem take?
- Under what circumstances does the problem occur?

When calling, please know the model and serial number of your appliance. This information is provided on the rating plate as follows:

- Model description
- S / N code (10 digits)

We recommend that you record the information here for easy reference.

Model:

Serial number:

When do you incur costs even during the warranty period?

- if you could have remedied the problem yourself by applying one of the solutions provided in the section “Troubleshooting,”
- if the customer service technician has to make several service calls because he was not provided with all of the relevant information before his visit and as a result, for example, has to make additional trips for parts. Preparing for your phone call as described above will save you the cost of these trips.

Technical Data

EN

Appliance dimensions

Width 575 mm
Depth 505 mm
Height 55 mm

Worktop cut - out dimensions

Width 560 mm
Depth 490 mm
Corner radius 3 mm

Cooking rings

Position	Diameter	Power
Front left	129 / 215 mm	810 / 2,380 W
Rear left	148 mm	1,300 W
Rear right	170 / 265 mm	1,590 / 2,540 W
Front right	148 mm	1,300 W

Connection voltage 240 V ~ 50 Hz
Maximum connected load power 7.52 kW
Weight : Net 8.0 kg
Gross 10.5 kg



Note



EN





ELECTRONICS

**If you have any questions or comments relating to Samsung products,
please contact the SAMSUNG customer care centre.**

Tel : 1300 362 603
www.samsung.com/au