

Vanilla

OPERATING & INSTALLATION
INSTRUCTIONS



Electric Cooker

ESV5060W

MOFFAT

16011105/R3

CONTENTS

Instructions for the User		Instructions for the Installer	
Important Safety Information	2	Safety Advice	17
Description of the appliance	4	Technical Data	17
Technical Features	5	Electrical Connection	18
Using the appliance	6	Stability Bracket	19
- Using the oven	6		
- Hints & Tips	8		
- Using the Grill	9		
- Using the Hob	10		
Maintenance and Cleaning	12		
Something Not Working	14		
Service & Spare Parts	15		
Customer Care	15		
Guarantee Conditions	16		

How to read the instruction book

The symbols below will guide you when reading the instruction book



Safety instructions



Step by Step Operation



Advice and recommendations



Environmental Information

IMPORTANT SAFETY INFORMATION



You MUST read these warnings carefully before installing or using the appliance. If you need assistance, contact our Customer Care Department on 08705 950950.

Installation

- This cooker must be installed by qualified personnel, according to the manufacturer's instructions and to the relevant British Standards.
- This cooker is heavy. Take care when moving it.
- Remove all packaging before using the cooker.
- Ensure that the electrical supply complies with the type stated on the rating plate.
- Do not attempt to modify the cooker in any way.
- Always ensure that the oven vent, which is located at the centre back of the hob, is left unobstructed to ensure ventilation of the oven cavity.
- Perishable food, plastic items and aerosols may be affected by heat and should not be stored above the cooker.

Child Safety

- This cooker is designed to be operated by adults. Do not allow children to play near or with the cooker.
- The cooker gets hot when it is in use. Children should be kept away until it has cooled.
- Children can also injure themselves by pulling pans or pots off the cooker.

During Use

- This cooker is intended for domestic cooking only. It is not designed for commercial or industrial purposes.
- Do not use this cooker if it is in contact with water. Do not operate the cooker with wet hands.
- Ensure the control knobs are in the 'OFF' position when not in use.
- Do not store flammable materials such as oven gloves, tea towels etc. in the drawer.
- When using electrical appliances, ensure the cable does not come into contact with the hot surfaces of the cooker.
- Unstable or misshapen pans should not be used on the hob burners as unstable pans can cause an accident by tipping or spillage.
- Never leave the cooker unattended when cooking with oil and fats.
- This cooker should be kept clean at all times. A build-up of fats or foodstuffs could result in a fire.
- Never use plastic or aluminium foil dishes on the hob.
- Never line any part of the oven with aluminium.

Service

- This cooker should only be repaired or serviced by an authorised Service Engineer and only genuine approved spare parts should be used.



Environmental Information

- After installation, please dispose of the packaging with due regard to safety and the environment.
- When disposing of an old appliance, make it unusable, by cutting off the cable.

Keep this instruction book for future reference and ensure it is passed to any new owner.

DESCRIPTION OF THE APPLIANCE

Hob

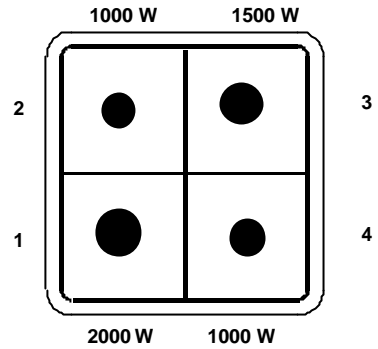
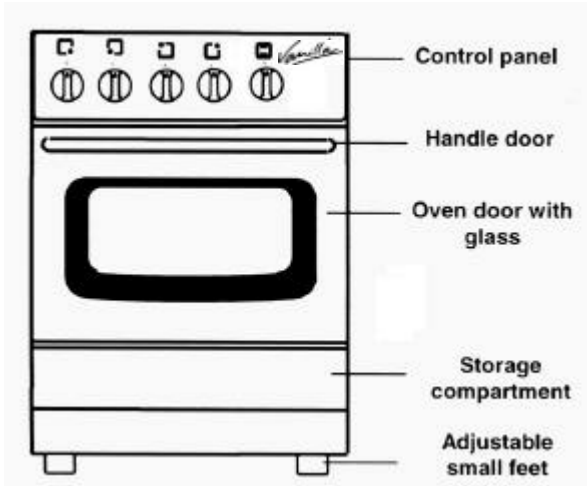

1. Front left solid hotplate (Rapid)
2. Back left solid hotplate
3. Back right solid hotplate
4. Front right solid hotplate

Control panel

Model : ESV 5060 W

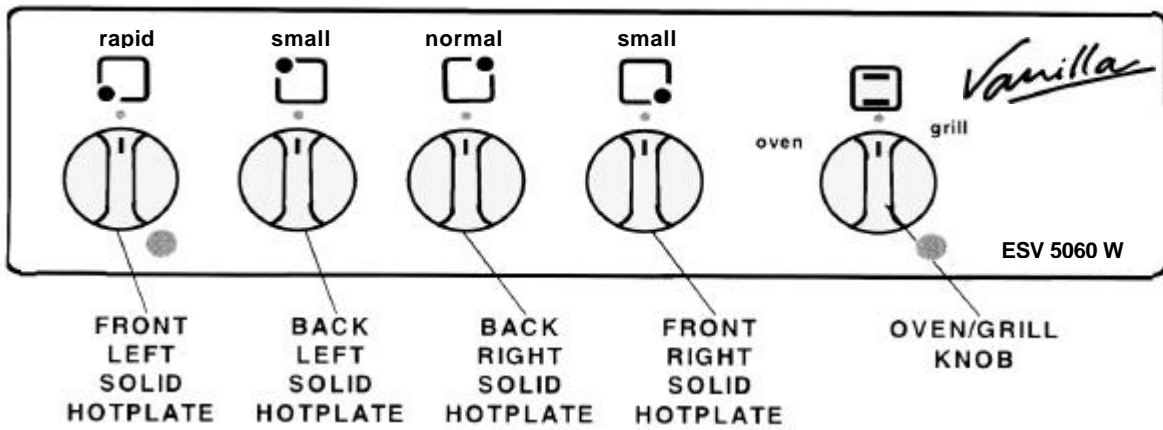

TECHNICAL FEATURES

Free standing

Class 1

Hob	Front right	1000 W
	Back right	1500 W
	Front left	2000 W
	Back left	1000 W
Oven	Oven	1750 W
	Top element only	750 W
	Bottom element only	1000 W
	Grill	1500 W
Dimensions	Height to the hotplate	900 mm
	Width	500 mm
	Depth	600 mm

 This appliance complies with the following EEC Directives : **89/336** (Electromagnetical Compatibility Directive) and subsequent modifications, and **73/23** Low Voltage Directive, **93/68** (General Directives) and subsequent modifications.

USING THE APPLIANCE

Before the First Use of the Cooker

 **Remove all packaging both inside and outside of the cooker, before using it.**

Before first use, the oven should be heated without food. During this time, an unpleasant odour may be emitted. This is quite normal.

- 1 Remove the oven accessories and ensure all packaging has been removed.
- 2 Set the oven function control knob to MAX
- 3 Open a window for ventilation
- 4 Allow the oven to run empty for approximately 45 minutes.

This procedure should be repeated with the grill function for approximately 5-10 minutes.

Using the Oven

 **Always cook with the oven door closed.**
Stand clear when opening the drop down oven door.
Do not allow it to fall open - support the door using the door handle, until it is fully open.

The oven has four shelf levels, and is supplied with one shelf.
The shelf positions are counted from the bottom of the oven as shown in the diagram.

 **Do not place cookware or foil directly on the oven base.**

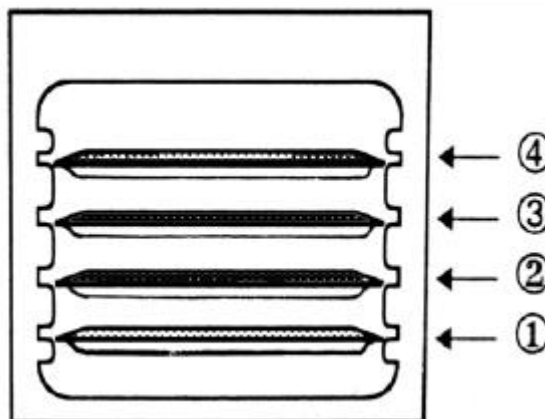

Use

This oven has four functions and they are:



Conventional Cooking



Top element only



Bottom element only



Grilling

The symbol on the knob corresponds to the symbol on the control panel.

●	Off
“ 200° ”	Maximum temperature for conventional oven.
“ 50° ”	Minimum temperature for conventional oven.
“Grill”	Grill function (heat comes from the top element only).
“Top”	Heat comes from top element only.
“Bottom”	Heat comes from bottom element only.

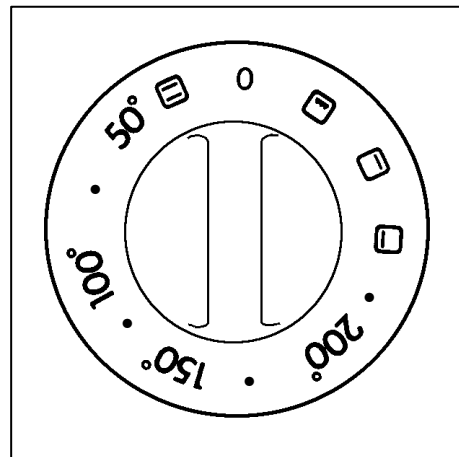

Cooking in the Oven

Traditional cooking is made by natural convection. It is necessary to pre-heat the oven.

It may be necessary to adjust the temperature to suit your individual requirements. Only experience will enable you to determine the correct setting for your personal requirements.

Top oven element only

This function is suitable for finishing cooked dishes, e.g.; lasagne, shepherds pie, cauliflower cheese etc.

Bottom oven element only

This function is particularly useful when blind-baking pastry or cooking pizza. It may also be used to finish off quiches or flans to ensure the base pastry is cooked through.

Hints and Tips

Condensation and steam

When food is heated it produces steam in the same way as a boiling kettle. The oven vents allow some of this steam to escape. However, **always stand back from the oven when opening the oven door** to allow any build up of steam or heat to release.

If the steam comes into contact with a cool surface on the outside of the oven, e.g. a trim, it will condense and produce water droplets. This is quite normal and is not a fault with the oven.

To prevent discoloration, regularly wipe away condensation and also soilage from surfaces.

Cookware

Use any ovenproof cookware which will withstand temperatures of 310⁰ C.

Baking trays, oven dishes, etc. should not be placed directly on the oven base.



Oven Cooking

- Turn off the oven 5 minutes before the end of cooking time, and use residual heat to complete the cooking.
- The thickness, the material and the colour of the pan will influence the cooking results.
- When cooking, certain dishes increase in volume, ensure the pan is large enough.
- To prevent fat dripping when roasting use tall rim pans proportional to the item being roasted.
- Prick the skin of poultry and sausages with a fork before cooking to avoid spitting.
- Use heatproof glass dishes for soufflés.

The effects of dishes on cooking results

Dishes and tins vary in their thickness, conductivity, colour, etc. which affects the way they transmit heat to the food inside them.

- A** Aluminium, earthenware, oven glassware and bright shiny utensils reduce cooking and base browning.
- B** Enamelled cast iron, anodised aluminium, aluminium with non-stick interior and coloured exterior and dark, heavy utensils increase cooking and base browning.

Storage compartment

The storage compartment is located underneath the oven cavity.



During cooking the storage compartment may become hot if the oven is in use for a long period of time. Flammable materials such as oven gloves, tea towels, plastic aprons etc. should not be stored in the drawer.

Oven accessories such as baking sheets, will also become hot, therefore care should be taken when removing these items from the compartment whilst the oven is in use or still hot.

Using the Grill

Grilling

 **Always grill with the oven door open.**

This cooker is not supplied with a grill handle.

When grilling, it is only the top element that is used. It is not necessary to preheat the grill.

- 1 Insert the meal on the 3rd level.
- 2 Turn the knob on position grill.
- 3 Adjust the grid and pan position to allow for different thicknesses of food. Position the food close the grill for faster cooking and further away for gentler cooking.

Heat comes from the top of the oven. It is suitable for grilling meat (beef bacon, pork bacon ...) that remains tender, for toast or to brown dishes already cooked.

Grilling meat

- Prepare the meat to be roasted, lightly brush it with oil on both sides.
- Place it on the roasting grid.
- Turn the oven/grill control knob to position "grill".
- Slide the roasting grid together with the roasting tray in the guide 2.
- When the first side is brown, turn the meat without pricking it in order that the juices are not lost.
- Roast the second side.

Cooking time is determined by the thickness of the piece to be roasted not by its weight.

Browning

- Turn the oven/grill control knob to the "grill" position.
- Place the dish on the grid and slide it in the guide 2 or 3.
- Leave the dish under the grill for a few minutes.

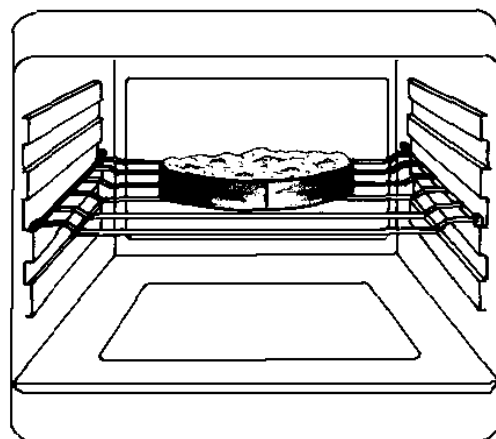
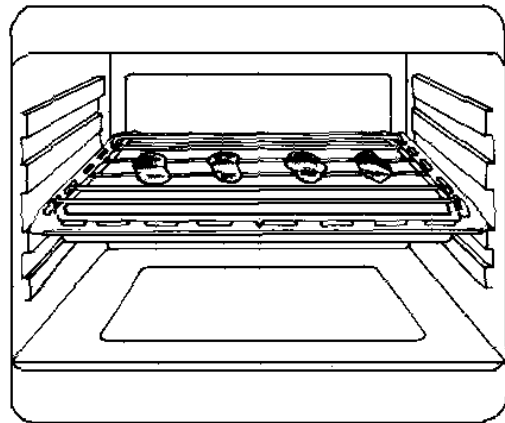

Using the Hob

The Hotplates

To switch on a hotplate, turn the relevant control knob to the required heat setting.

The control knob is numbered 1 – 3 with seven positions.

0 - OFF

- - Minimum
- 3 - Maximum.

The hob has two types of hotplates:

Rapid Hotplate (Front left)

The rapid hotplates will heat up more quickly than a normal plate.

Normal Hotplates

We recommend the plates are switched to maximum (3) for a short while to boost the plate, and then adjusted to the required setting.



It is important to note that the plate may smoke a little and produce a slightly unpleasant odour when used for the first time. This is quite normal and will disappear after a few minutes.

Suggestions for the correct setting of the plates are given in the following table.

OFF	0	
Very Gentle	▪	To keep food warm To melt butter and chocolate
Gentle	1	To prepare cream-sauces, stews and milk puddings or to fry eggs
Slow	▪	Dried vegetables, frozen food, fruit, boiling water or milk
Medium	2	Boiled potatoes, fresh vegetables, pâtés, soups, broths, pancakes or fish
High	▪	Larger stews, meat roll, fish, omelettes, steaks
Fry	3	Steaks, escalopes and frying.

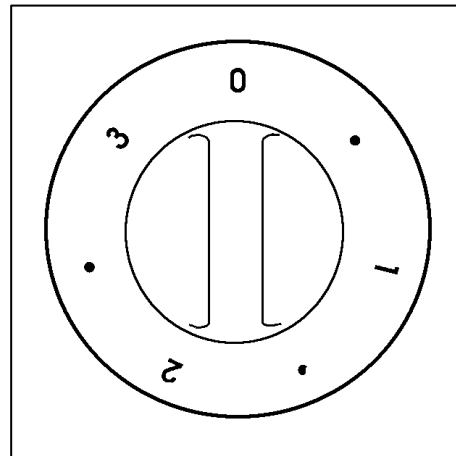

Do not put anything on the hob that is liable to melt.

Selecting the hotplate



Above every knob there is a symbol for the corresponding hotplate.

For good cooking results, always choose pans which properly fit the diameter of the hotplate used (see figs).

Saucepans for use on solid plates should have several characteristics:

- They should be fairly heavy duty
- They should fit the heat area exactly, or be slightly larger for efficient use, NEVER smaller.
- They should have a flat base to ensure good contact with the plate.

This is particularly important when using pans for high temperature frying or pressure cooking.

As soon as liquid starts boiling, turn down the plate control knob so that it will barely keep the liquid simmering.

You can switch off the plate a short while before you finish cooking, and the final stage will be completed on the accumulated heat. Similarly, stews etc. cooked in well covered saucepans cook at lower temperature which is more economical.



*Ensure pans are large enough to avoid liquids being spilt onto the plates.
Never leave the plates on without a pan on them or with an empty pan on them.
Take care never to lean or reach over a hot electric plate.*

*Always point pan handles inward or over the work surface next to the hob to avoid accidentally knocking over a pan as you pass by.
Take care when frying food in hot oil or fat, as the overheated splashes could easily ignite.*

If the control knobs become difficult to turn, please contact your local Service Centre.

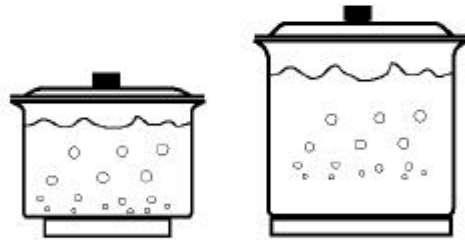
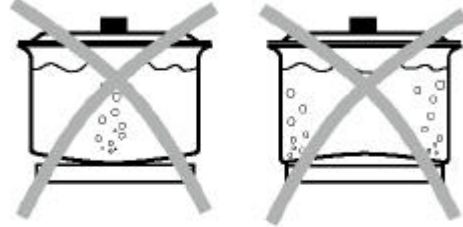
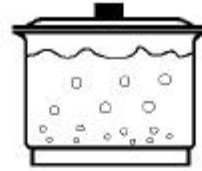

MAINTENANCE AND CLEANING

 **The oven should be kept clean at all times. A build-up of fats or other foodstuffs could result in a fire, especially in the grill pan.**

 **Before cleaning, ensure all control knobs are in the OFF position, and the appliance has cooled completely.**

Cleaning materials

Before using any cleaning materials on your oven, check that they are suitable and that their use is recommended by the manufacturer.

 **Cleaners that contain bleach should NOT be used as they may dull the surface finishes. Harsh abrasives should also be avoided.**

External cleaning

Regularly wipe over the control panel, oven door and door seal using a soft cloth well wrung out in warm water to which a little washing up liquid has been added.

 **To prevent damaging or weakening the door glass panels avoid the use of the following:**

- Household detergent and bleaches
- Impregnated pads unsuitable for non stick saucepans
- Brillo/Ajax pads or steel wool pads
- Chemical oven pads or aerosols
- Rust removers
- Bath/Sink stain removers

Oven Cavity

The enameled oven cavity is best cleaned whilst the oven is still warm.

Wipe the oven over with a soft cloth soaked in warm soapy water after each use. From time to time it will be necessary to carry out a more thorough cleaning, using a proprietary cleaner.

Oven Door

The door can be dismantled for cleaning as follows:

- Open the door completely
- There is a small ring on each hinge. Pull the ring over the claw-like mechanism. Do this for both hinges. See picture 1.

- Raise the door slightly and pull it straight outwards away from the oven. The door will come completely off. See picture 2.
- When replacing the door, locate it back into the hinge holes. Pull it down fully and slip the rings off the claw-like hooks.

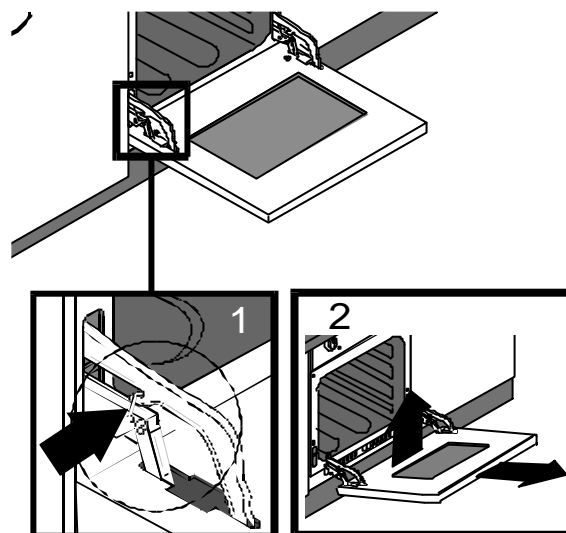
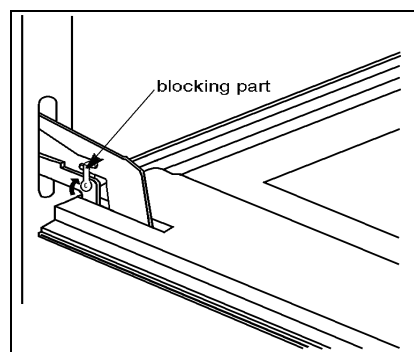

 **DO NOT clean the oven door while the glass panels are warm. If this precaution is not observed the glass panel may shatter. If the door glass panel becomes chipped or has deep scratches, the glass will be weakened and must be replaced to prevent the possibility of the panel shattering. Contact your local Service Force Centre who will be pleased to advise further.**

MAINTENANCE AND CLEANING



Before any maintenance or cleaning can be carried out, you must **DISCONNECT** the cooker from the electricity supply.

The Hob Top

The hob is best cleaned whilst it is still warm, as spillage can be removed more easily than if it is left to cool.

Regularly wipe over the hob top using a soft cloth well wrung out in warm water to which a little washing up liquid has been added. Avoid the use of the following:

- household detergent and bleaches;
- impregnated pads unsuitable for non-stick saucepans;
- steel wool pads;
- bath/sink stain removers.

Should the hob top become heavily soiled, it is recommended that a cleaning product such as Hob Brite or Bar Keepers Friend is used.

The Hotplates

Spills onto the actual plate should be removed using warm water and a soft brush, nylon or plastic scourer.

To keep the plates looking as new, hotplate conditioner can be purchased from most hardware stores, e.g. "4 Hob" by HomeCare Products (follow the manufacturer's instruction for use).

Alternatively, wipe the plates with a drop of olive oil on a kitchen towel to avoid rust. It is important to note that the plate will smoke a little and produce a slightly unpleasant odour when next used.

Drying

Important: After cleaning, dry the hotplates thoroughly by switching on to a low-medium setting for a few minutes.



Restoring

To maintain the appearance of your sealed hotplates apply a little salt-free vegetable oil or restorative agent (i.e. "Collo Electrol", or Minky Hotplate Cleaning Cloths) periodically.

To apply vegetable oil: first heat the hotplate on a medium setting for 30 seconds then turn off. Pour a very small amount of salt-free oil onto a dry cloth or kitchen paper. Apply a thin coat of oil to the hotplate surface and wipe off any excess. Heat the hotplate on a medium setting for 1 minute.

To apply restorative agent: first heat the hotplate on a medium setting for 30 seconds then turn off. Apply a very thin coating of Collo Electrol (using the applicator). Heat the hotplate on a high setting for 2-3 minutes to cure. Some smoke will occur, this is normal and non-toxic. (NB: this product is a restorative agent not a cleanser. It is available from hardware stores).

Stainless steel parts: the stainless steel spill rings may become straw coloured with use. Use a proprietary stainless steel cleaner to remove this straw discolouration. This also applies to the area around the hotplates on stainless steel hobs.

SOMETHING NOT WORKING

If the appliance is not working correctly, please carry out the following checks, before contacting your local Service Force Centre.

IMPORTANT: If you call out an engineer to a fault listed below, or to repair a fault caused by incorrect use or installation, a charge will be made even if the appliance is under guarantee.

Symptoms	Solutions
<ul style="list-style-type: none"> • The hob hotplate does not heat up. • The plate is not giving satisfactory results • The oven does not come on • It takes too long to finish the dishes, or they are cooked too fast. • Steam and condensation settle on the food and the oven cavity. 	<ul style="list-style-type: none"> • Check that the cooker is plugged in and the electrical connection is switched on. • Check that the RCCB has not tripped (if fitted). • Check the mains fuse has not blown. • Check that the correct control knob has been turned. • Check that the plate is clean and dry. • Check that the cooking pan is the correct size for the plate. • Check the cooking pan has a flat bottom. • Check the setting is correct for the type of cooking. • Check that a cooking function / temperature has been selected. • Check that the cooker is plugged in and the electrical connection is switched on. • The temperature may need adjusting. • Refer to the instruction under 'Hints & Tips'. • Leave the dishes inside the oven no longer than 15-20 minutes after the cooking has completed.

If after these checks, the appliance still does not operate correctly, contact your local Service Force Centre. When you contact the Service Centre, they will need the following information:

- 1 Your name, address and postcode.
- 2 Your telephone number
- 3 Clear and concise details of the fault
- 4 The model and serial number (see rating plate)
- 5 Date of purchase

SERVICE & SPARE PARTS

If you require spare parts or an engineer contact your local Service Force Centre by telephoning:

08705 929929

Your call will be routed to the Service Centre covering your postcode area.

Before calling out an engineer, please ensure you have read the details under the heading "Something Not Working" and have the model number and purchase date to hand.

In-guarantee customers should ensure that the checks under the heading "Something Not Working" have been made as the engineer will make a charge if the fault is not a mechanical or electrical breakdown. Please note that it will be necessary to provide proof of purchase for any in-guarantee service calls.

Moffat (Vanilla) have an agreement with Electrolux who will undertake all servicing requirements for your appliance.

CUSTOMER CARE

For general enquiries concerning your Moffat (Vanilla) appliance and or for further information on other Electrolux products, contact our Customer Care Department by letter or telephone as follows:

Customer Care Department
Electrolux
55-77 High Street
Slough
Berkshire SL1 1DZ

Tel: 08705 950950 *

* calls to this number may be recorded for training purposes.

GUARANTEE CONDITIONS

Standard Guarantee Conditions

We Moffat undertake that if, within 12 months of the date of the purchase, this Moffat appliance or any part thereof is proved to be defective by any reason only of faulty workmanship or materials, we will, at our option, repair or replace the same FREE OF ANY CHARGE for labour, materials or carriage on condition that:

- The appliance has been correctly installed and used only on the gas and electricity supply stated on the rating plate.
- The appliance has been used for normal domestic purposes only, and in accordance with the manufacturer's instructions.
- The appliance has not been serviced maintained, repaired, taken apart or tampered with by any person not authorised by us.
- All service work under this guarantee must be undertaken by an Electrolux Service Force Centre.
- Any appliance or defective part replaced shall become the Company's property.
- This guarantee is in addition to your statutory and other legal rights.

Home visits are made between **8.30am and 5.30pm** Monday to Friday. Visits may be available outside these hours, in which case a **premium** will be charged.

Exclusions

This guarantee does not cover:

- Damage or calls resulting from transportation, improper use or neglect, the replacement of any light bulbs or removable parts of glass or plastic.
- Costs incurred for calls to put right an appliance which is improperly installed or calls to appliance outside the United Kingdom.
- Appliances found to be in use within a commercial or similar environment, plus those, which are the subject to rental agreements.
- Products of Moffat manufacture which are not marketed by Moffat

European Guarantee

If you should move to another country within Europe then your guarantee moves with you to your new home subject to the following qualifications:

- The guarantee starts from the date you first purchased your product.
- The guarantee is for the same period and to the same extent for labour and parts as exist in the new country of use for this brand or range of products.
- This guarantee relates to you and cannot be transferred to another user.
- Your new home is within the European Community (EC) or European Free Trade Area.
- The product is installed and used in accordance with our instructions and is only used domestically, i.e. a normal household
- The electrical supply complies with the specification given in the rating label.
- The product is installed taking into account regulations in your new country.

Before you move, please contact your nearest Customer Care Centre, listed below, to give them details of your new home. They will then ensure that the local Service Organisation is aware of your move and able to look after you and your appliances.

France	Senlis	+33 (0)3 44 62 22 22
Germany	Nürnberg	+49 (0)911 323 2600
Italy	Pordenone	+39 (0)1678 47053
Sweden	Stockholm	+46 (0)20 78 77 50
UK	Slough	+44 (0)1753 219898

INSTRUCTIONS FOR THE INSTALLER



Safety Advice

This cooker must be installed in accordance with the IEE Wiring Regulations (Current Edition).

Detailed recommendations are contained in the following British Standards Codes Of Practice: B.S. 6172/ B.S. 5440, Par. 2 and B.S. 6891 Current Editions.

Location

This cooker has been registered as a "Class X" appliance according to Fire Risk Regulations. Any adjacent cabinets or walls must not exceed the cooker's height.

The cooker may be located in a kitchen, a kitchen/diner or bed sitting room, but not in

a bathroom or shower room.

The minimum distance combustible material can be fitted above the cooker in line with the edges of the cooker is 420 mm. If it is fitted below 420 mm. a space of 50 mm. must be allowed from the edges of the cooker.

The minimum distance combustible material can be fitted directly above the cooker is 700 mm.

The adjacent furniture panels have to be heat proof or protected by such material.

TECHNICAL DATA

Dimensions

Height	900mm	Oven	1750 W
Depth	600mm	Conventional (both elements)	750 W
Width	500mm	Top element	1000 W
Oven Capacity	1.942 Cu. ft	Bottom element	230-240 V
Hob		Supply voltage (50Hz)	
Front left heating plate (rapid)	2000 W		
Back left heating plate (normal)	1000 W		
Back right heating plate (normal)	1500 W		
Front right heating plate (normal)	1000 W		
Total Rating	5500 W		

ELECTRICAL CONNECTIONS

 Any electrical work required to install this hob should be carried out by a qualified electrician or competent person, in accordance with the current regulations.

 **THIS COOKER MUST BE EARTHED.**

The manufacturer declines any liability should these safety measures not be observed.

 **This cooker is designed to be connected to a 230-240V 50Hz AC electrical supply.**

Before switching on, make sure the electricity supply voltage is the same as that indicated on the hob rating plate. The rating plate is located on the bottom of the hob.

The cooker is supplied without a supply cord. A supply cord must be fitted, in accordance with the specification given in the relevant tables.



1. Loosen the two fixing screws securing the back protective screen of the cooker, then lift it up and remove it. This will expose the terminal block on the right bottom corner.
2. Loosen the two cable clamp screws and lift the top section of the clamp enough to allow the cable to be passed through.
3. Connect the red (live) wire to the terminal which is marked with the letter "L".
4. Connect the black (neutral) wire to the terminal which is marked with the letter "N".
5. After fitting a green or yellow/green sleeve over the bare copper wire (earth wire), connect the exposed end to the terminal which is marked with the earth symbol  or with the letter "E" coloured green and yellow.

NOTE:

The earth wire should be about 2 cm. longer than the live and neutral wires.

6. Secure the cable by means of the clamp screws and refit the back protective screen.

The cooker should be connected to a double pole switch with a minimum gap of 3 mm. between the switch contacts and of a type suitable for the required load in compliance with the current electric regulations. The switch should be sited within 2m of the hob and be easily accessible upon completion of the installation.

The switch must not break the yellow and green earth cable at any point.

Ensure that the hob supply cord does not come into contact with surfaces with temperatures higher than 50 deg.C.

Supply Cable Specifications

For UK use only

Connection Via	Min. size Cable	Fuse
Cooker Control Circuit	6 mm² Twin & Earth	30 A

For European use only

Min. Size Cable	Cable / flex type	Fuse
3 x 2.5 mm²	H05 W-F	30 A

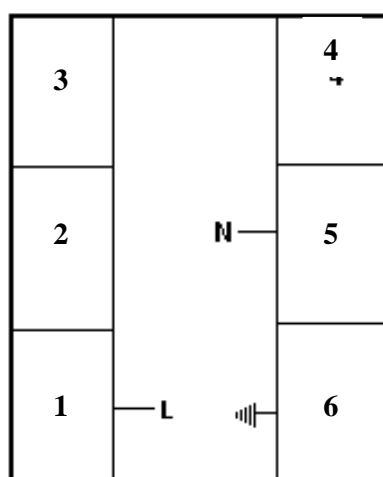

STABILITY BRACKET

To reduce the risk of the appliance tipping due to improper use or door loading, it must be securely installed using the stability bracket supplied.

1. Place the stability bracket on the floor as shown in figure 2.
If there is no side wall, the dimension given as 0.5 cm will be the distance of the left / right side of the appliance to left / right of the stability bracket. If there is a side wall, the dimension given as 2.5 cm will be the distance of the left / right side of the stability bracket to the side wall.
If your appliance is 50 cm wide, the distance between the back wall and the top edge plate should be zero.
2. Mark the locations of the 2 holes of the stability bracket on the floor.
3. Use a 7.5 mm masonry drill bit to make the holes and insert the plastic anchor.
4. Secure the bracket to the floor using the screws supplied.
5. Slide the appliance into place (Figure 1).

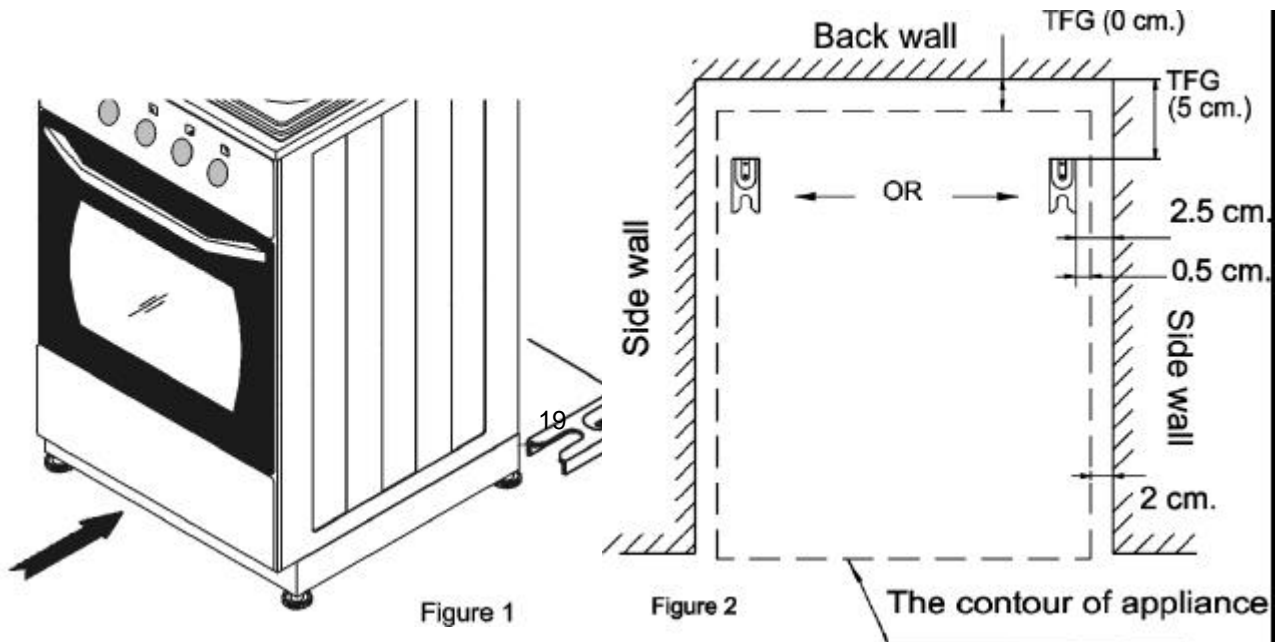

Vanilla

Moffat (Vanilla), 55-77 High Street, Slough, Berkshire, SL1 1DZ

Customer Care telephone number...
08705 950950