



AXIS 214 PTZ  
Network Camera  
User's Manual

## About this Document

This manual is intended for administrators and users of the AXIS 214 PTZ PTZ Network Camera, and is applicable for software release 4.40. Previous experience of networking will be of use when installing and using this product. Some knowledge of UNIX or Linux-based systems may also be beneficial, for developing shell scripts and applications. Later versions of this document will be posted to the Axis Website, as required.

## Safety Notices Used In This Manual

**Caution!** - Indicates a potential hazard that can damage the product.  
**Important!** - Indicates a hazard that can seriously impair operation.  
Do not proceed beyond any of the above notices until you have fully understood the implications.

## Intellectual Property Rights

Axis AB has intellectual property rights relating to technology embodied in the product described in this document. In particular, and without limitation, these intellectual property rights may include one or more of the patents listed at <http://www.axis.com/patent.htm> and one or more additional patents or pending patent applications in the US and other countries.

This product contains licensed third-party software. See the menu item "About" in the product's user interface for more information.

This product contains source code copyright Apple Computer, Inc., under the terms of Apple Public Source License 2.0 (see <http://www.opensource.apple.com/apsl/>). The source code is available from: <http://developer.apple.com/darwin/projects/bonjour/>

## Legal Considerations

Video surveillance can be prohibited by laws that vary from country to country. Check the laws in your local region before using this product for surveillance purposes.

## Electromagnetic Compatibility (EMC)

If use of this equipment causes harmful interference to radio or television reception, which can be determined by turning the equipment off and on, the user is encouraged to try to correct the interference by one or more of the following measures: Re-orient or relocate the receiving antenna. Increase the separation between the equipment and receiver. Connect the equipment to an outlet on a different circuit to the receiver. Consult your dealer or an experienced radio/TV technician for help. Shielded (STP) network cables must be used with this unit to ensure compliance with EMC standards.

**USA** - This equipment has been tested and found to comply with the limits for a Class A digital device, pursuant to Part 15 of the FCC rules. These limits are designed to provide reasonable protection against harmful interference when the equipment is operated in a commercial environment. This equipment generates, uses and can radiate radio frequency energy and, if not installed and used in accordance with the instruction manual, may cause harmful interference to radio communications. Operation of this equipment in a residential area is likely to cause interference, in which case the user will be required to correct the interference at his own expense.

**Canada** - This Class A digital apparatus complies with Canadian ICES-003.

**Europe** -  This digital equipment fulfills the requirements for radiated emission according to limit A of EN55022/1998, and the requirements for immunity according to EN55024/1998 residential, commercial, and industry. **Warning!** This is a Class A product. In a domestic environment this product may cause radio interference, in which case the user may be required to take adequate measures.

**Japan** - This is a class A product based on the standard of the Voluntary Control Council for Interference by Information Technology Equipment (VCCI). If this equipment is used in a domestic environment, radio disturbance may arise. When such trouble occurs, the user may be required to take corrective action.

**Australia** - This electronic device meets the requirements of the Radio communications (Electromagnetic Compatibility) Standard 1998 AS/NZS 3548. **Warning!** This is a Class A product. In a domestic environment this product may cause radio interference, in which case the user may be required to take adequate measures.

## Liability

Every care has been taken in the preparation of this manual. Please inform your local Axis office of any inaccuracies or omissions. Axis Communications AB cannot be held responsible for any technical or typographical errors and reserves the right to make changes to the product and manuals without prior notice. Axis Communications AB makes no warranty of any kind with regard to the material contained within this document, including, but not limited to, the implied warranties of merchantability and fitness for a particular purpose. Axis Communications AB shall not be liable nor responsible for incidental or consequential damages in connection with the furnishing, performance or use of this material.

## Trademark Acknowledgments

Ethernet, Internet Explorer, Linux, Microsoft, Mozilla, OS/2, UNIX, Wfine, Windows, WWW are registered trademarks of the respective holders. Java and all Java-based trademarks and logos are trademarks or registered trademarks of Sun Microsystems, Inc. in the United States and other countries. Axis Communications AB is independent of Sun Microsystems Inc. UPnP™ is a certification mark of the UPnP™ Implementers Corporation. Bonjour is a trademark of Apple Computer Inc.

## Support

Should you require any technical assistance, please contact your Axis reseller. If your questions cannot be answered immediately, your reseller will forward your queries through the appropriate channels to ensure a rapid response. If you are connected to the Internet, you can:

- download user documentation and firmware updates
- find answers to resolved problems in the FAQ database. Search by product, category, or phrases
- report problems to Axis support by logging in to your private support area

## Safety Notice - Battery Replacement

The AXIS 214 PTZ uses a 3.0V CR2032 Lithium battery as the power supply for its internal real-time clock (RTC). Under normal conditions this battery will last for a minimum of 5 years. Low battery power affects the operation of the RTC, causing it to reset at every power-up. A log message will appear when the battery needs replacing. The battery should not be replaced unless required!

If the battery does need replacing, please observe the following:

- Danger of Explosion if battery is incorrectly replaced
- Replace only with the same or equivalent battery, as recommended by the manufacturer.
- Dispose of used batteries according to the manufacturer's instructions.

Visit Axis Support at [www.axis.com/techsup/](http://www.axis.com/techsup/)

## RoHS

This product complies with both the European RoHS directive, 2002/95/EC, and the Chinese RoHS regulations, ACPEIP.



## WEEE Directive

The European Union has enacted a Directive 2002/96/EC on Waste Electrical and Electronic Equipment (WEEE Directive). This directive is applicable in the European Union member states.



The WEEE marking on this product (see right) or its documentation indicates that the product must not be disposed of together with household waste. To prevent possible harm to human health and/or the environment, the product must be disposed of in an approved and environmentally safe recycling process. For further information on how to dispose of this product correctly, contact the product supplier, or the local authority responsible for waste disposal in your area.

Business users should contact the product supplier for information on how to dispose of this product correctly. This product should not be mixed with other commercial waste.

|  |
|--|
| AXIS 214 PTZ User's Manual<br>Revision 2.0<br>Part No: 29886<br>April 2007<br>Copyright© Axis Communications AB, 2006-2007 |
|--|

# Table of contents

---

|   |    |
|---|----|
| Product Description .....                         | 5  |
| Rear panel .....                                  | 6  |
| Accessing the camera .....                        | 7  |
| Accessing the camera from a browser .....         | 7  |
| Setting the password for root .....               | 7  |
| Accessing the camera from the Internet .....      | 7  |
| The Live View page .....                          | 8  |
| Pan/Tilt/Zoom controls .....                      | 8  |
| Viewer controls .....                             | 9  |
| PTZ Control Queue .....                           | 10 |
| Video and Audio Streams .....                     | 11 |
| Video Stream Types .....                          | 11 |
| Audio Stream Types .....                          | 11 |
| MPEG-4 protocols and communication methods .....  | 12 |
| How to stream MPEG-4 .....                        | 12 |
| AXIS Media Control .....                          | 12 |
| Other methods of accessing the video stream ..... | 13 |
| The Setup Tools .....                             | 14 |
| Accessing the setup tools from a browser .....    | 14 |
| Video & Image settings .....                      | 15 |
| Image .....                                       | 15 |
| Overlay Image .....                               | 16 |
| Advanced Camera Settings .....                    | 17 |
| MPEG-4 .....                                      | 17 |
| AXIS Media Control .....                          | 17 |
| Audio .....                                       | 18 |
| Basic Audio Settings .....                        | 18 |
| Advanced Audio Settings .....                     | 19 |
| Live View Config .....                            | 21 |
| Layout .....                                      | 21 |
| HTML Examples .....                               | 23 |
| External Video .....                              | 23 |
| Sequence Mode .....                               | 23 |
| PTZ Configuration .....                           | 24 |
| Preset Positions .....                            | 24 |
| Guard Tour .....                                  | 24 |
| Advanced - Limits .....                           | 24 |
| Advanced - Ctrl Panel .....                       | 24 |
| Control Queue .....                               | 24 |
| Event configuration .....                         | 25 |
| Terminology .....                                 | 25 |

|  |    |
|--|----|
| Event servers                                  | 25 |
| Event types                                    | 26 |
| Triggered events                               | 26 |
| Scheduled events                               | 27 |
| Motion Detection                               | 27 |
| Port Status                                    | 28 |
| System Options                                 | 29 |
| Security - Users                               | 29 |
| Security - IP Address Filter                   | 29 |
| Security - HTTPS                               | 29 |
| Security - 802.1x                              | 31 |
| Date & Time                                    | 32 |
| Network - Basic TCP/IP Settings                | 32 |
| Network - Advanced TCP/IP Settings             | 33 |
| Network - SOCKS                                | 35 |
| Network - QoS (Quality of service)             | 35 |
| Network - SMTP (email)                         | 35 |
| Network - SNMP                                 | 35 |
| Network - UPnP™                                | 35 |
| Network - RTP / MPEG-4                         | 35 |
| Network - Bonjour                              | 36 |
| Ports & Devices - I/O Ports                    | 36 |
| Maintenance                                    | 36 |
| Support  | 36 |
| Advanced                                       | 37 |
| Resetting to the factory default settings      | 37 |
| Connections                                    | 38 |
| I/O inputs and outputs                         | 38 |
| Schematic connection diagram                   | 38 |
| Connecting audio equipment                     | 38 |
| Troubleshooting                                | 39 |
| Checking the Firmware                          | 39 |
| Updating the Firmware                          | 39 |
| Support  | 39 |
| Symptoms, Possible Causes and Remedial Actions | 40 |
| Technical Specifications                       | 42 |
| General performance considerations             | 44 |
| Optimizing your system                         | 44 |
| Frame rates - Motion JPEG                      | 45 |
| Frame rates - MPEG-4                           | 45 |
| Bandwidth                                      | 45 |
| Glossary of Terms                              | 46 |
| Index  | 51 |

## Product Description

---

The AXIS 214 PTZ is a fully-featured PTZ Network Camera for security surveillance and remote monitoring. With its removable automatic IR filter, the camera supports automatic day & night functionality.



The AXIS 214 PTZ is equipped with 1 input and 1 output, for connecting external devices, e.g. door switches, etc. Two-way audio is supported by the LINE/MIC IN and LINE OUT ports.

Images from the camera are made available on the network as real-time, full frame rate Motion JPEG streams and/or MPEG-4 video streams. Up to 10 viewers can access the AXIS 214 PTZ simultaneously when using Motion JPEG and MPEG-4 unicast. The number of simultaneous viewers can be increased by using multicast MPEG-4. Video can be viewed in 5 resolutions (up to 768x576).

The AXIS 214 PTZ contains advanced scheduling tools that can be used to trigger an event. As the camera is designed for use in security systems, it is also equipped with security features such as IP address filtering, HTTPS and multi-level users. The built-in web server provides full access to all features through the use of a standard web browser.

## Rear panel

The rear panel provides access to all of the available connections on the AXIS 214 PTZ. The view shown here is from a ceiling mounted camera.

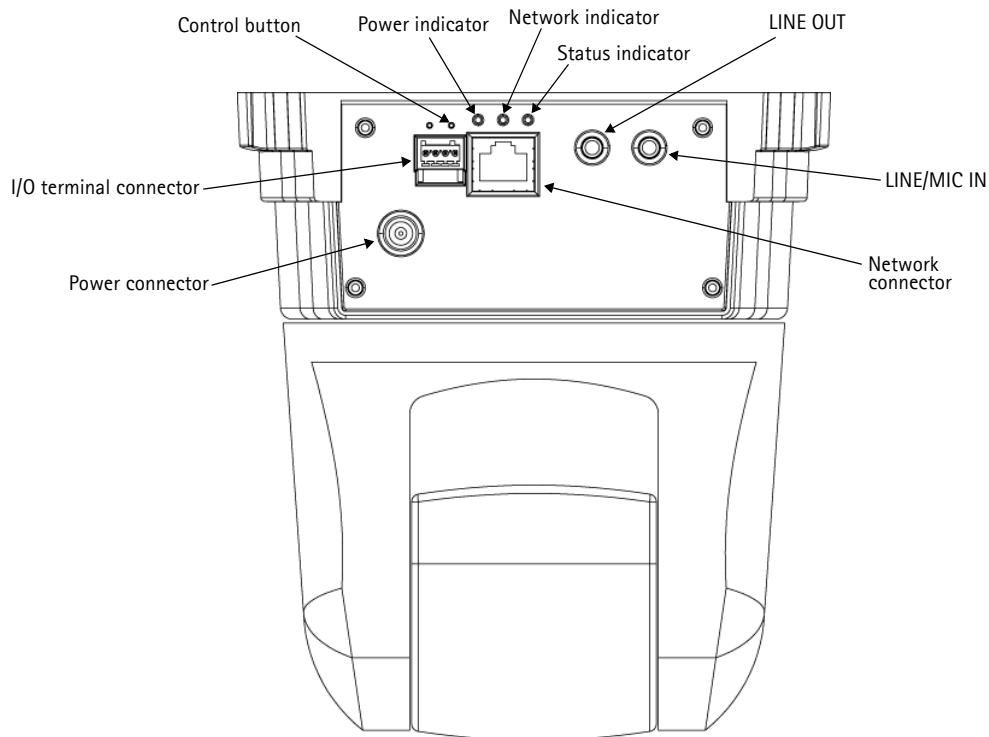

**Control button** - This is used to restore the factory default settings, as described in *Resetting to the factory default settings*, on page 37.

**Indicators** - After completion of the startup and self-test routines, the multi-colored Network, Status and Power indicators flash as follows:

|         |       |   |
|---------|-------|---|
| Network | Amber | Flashes for activity on a 10 Mbit/s network                           |
|         | Green | Flashes for activity on a 100 Mbit/s network                          |
|         | None  | No connection   |
| Status  | Green | Normal operation  |
|         | Amber | Flashes during startup, reset to factory default and firmware upgrade |
| Power   | Green | Normal operation  |
|         | Amber | Flashes green/amber during upgrade                                    |

**I/O terminal connector** - The I/O terminal connector provides the physical interface to one transistor output, one digital input and an auxiliary connection point for DC power. For more information, see *I/O inputs and outputs*, on page 38.

**Network connector** - The AXIS 214 PTZ connects to the network via a standard network cable. The speed of the local network segment (10BaseT/100BaseTX Ethernet) is automatically detected.

**LINE OUT** - For connecting a public address (PA) system or an active speaker with a built-in amplifier. A stereo connector must be used for the audio out.

**LINE/MIC IN** - Input for a mono microphone, or for a line-in mono signal (only the left channel is used from a stereo signal)

**Power connector** - For connection of the power adapter (included).

## Accessing the camera

The AXIS 214 PTZ can be used with most standard operating systems, and supports Microsoft Internet Explorer 5.x or later, Netscape 7.x or later and Mozilla 1.4 or later.

### Accessing the camera from a browser

1. Start a browser (Internet Explorer, Mozilla, Netscape Navigator).
2. Enter the IP address or host name of the AXIS 214 PTZ in the Location/Address field of your browser.
3. Enter the user name and password set by the administrator. If required, click Yes to install the AXIS Media Control (AMC).



The Live View page is then displayed in your browser.

**Note:** If this is the first time the camera is accessed, the 'Configure Root Password' dialog will be displayed on the screen. "root" is the default administrator user name.

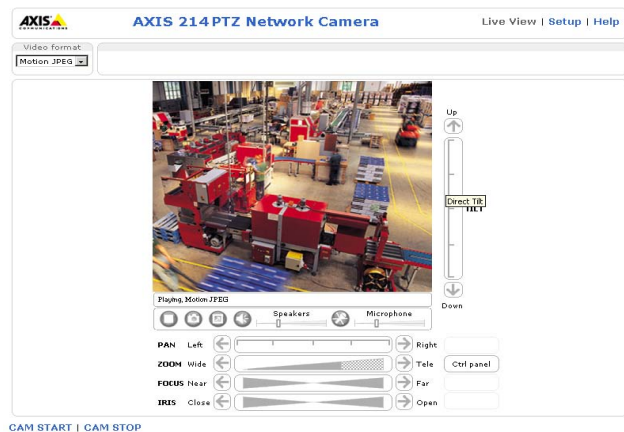

### Setting the password for root

1. Enter a password and then re-enter it to confirm the spelling. Click **OK**.
2. The 'Enter Network Password' dialog will appear. Enter the User name: **root**.
3. Enter the password as set above, and click **OK**. If the password is lost, the cameras must be reset to the factory default settings. See page 37.

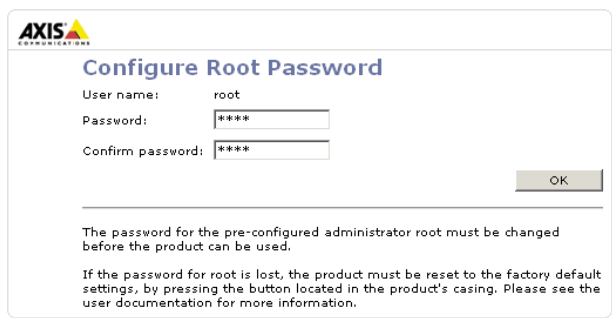

#### Notes:

- The layout of the Live View page in the AXIS 214 PTZ may have been customized to meet the specific requirements of the application. Consequently, many of the examples and functions in this section may differ from those displayed in your Live View page.
- If the AXIS 214 PTZ is to be mounted on a ceiling, the image must be rotated. Go to Setup > Video & Image and set Rotate image to 180 degrees.
- To view streaming video with AXIS Media Control (AMC) in Microsoft Internet Explorer, you must set your browser to allow the to be installed on your computer. The first time an MPEG-4 video stream is accessed, AMC also installs an MPEG-4 decoder for viewing the video stream. As a license is required for each instance of the decoder, the product administrator may have disabled the installation. If your workstation restricts the use of additional software components, the cameras can be configured to use a Java applet for updating JPEG images. See the online help for more information.

### Accessing the camera from the Internet

Once installed, the camera is accessible on your local network (LAN). To access the camera from the Internet you must configure your router/firewall to allow incoming data traffic. For security reasons this is usually done on a specific port. Please refer to the documentation for your router/firewall for further instructions. For more information, please visit the AXIS Internet Dynamic DNS Service at [www.axiscam.net](http://www.axiscam.net) or, for technical notes on this and other topics, visit the Axis Support Web at [www.axis.com/techsup](http://www.axis.com/techsup)

## The Live View page

The following provides an overview of the controls found on the Live View page. If the AXIS 214 PTZ has been customized (from Setup > Live View Config > Layout), the controls will be displayed accordingly:

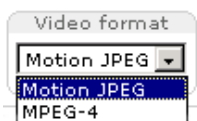

The Video Format drop-down list allows the video format on the Live View page to be temporarily changed.

The 2 types of Output button each control the output directly from the Live View page. These are configured under Setup > Live View Config > Layout.



**Pulse** - click this button to activate the output for a defined period of time, e.g. to switch on a light for 20 seconds.



**Active/Inactive** - click these buttons to manually start and stop a connected device, e.g. switch a light on/off.



These buttons start/stop the **Sequence Mode** which automatically displays the view from preset positions at set intervals. Sequence mode is configured in Setup > PTZ Configuration > Sequence Mode.



The source list is used to select the preset positions already configured in the camera. These are created in Setup > PTZ Configuration > Preset Positions.



The **Manual trigger buttons** trigger an action directly from the Live View page. These buttons are configured under Setup > Live View Config > Layout. Click these buttons to manually start and stop events.



Use the **Snapshot** button to capture a snapshot of the image currently being displayed in the window. Right-click on the image to save it in JPEG format on your computer.

## Pan/Tilt/Zoom controls

The Live View page also displays the **Pan/Tilt/Zoom controls**. These are enabled/disabled for specified users by the administrator under System Options > Security > Users > User List.

The Pan Tilt and Zoom bars control their respective functions in two different ways. Clicking anywhere on the bar's gradient allows for a 'smooth' adjustment of the camera's position, whilst clicking on the arrows at the two ends of the bar causes a stepped, incremental change.

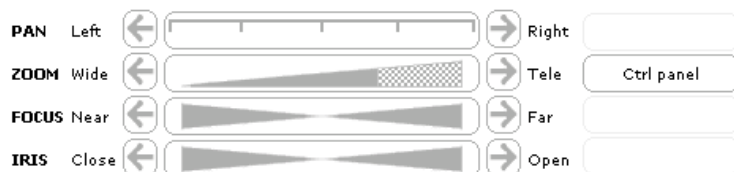

**Note:** Setting the iris and focus manually will disable Auto iris/Auto focus.



### Control panel

Click the **Ctrl panel** button to display the control panel, which provides the following settings:

- **Auto focus:** Automatically adjusts the image focus.
- **Auto iris:** Automatically adjusts the amount of light reaching the camera and gives the best results, This also protects the image sensor from strong light.
- **Backlight comp:** Enabling backlight compensation makes the subject clearer if the image background is too bright, or if the subject is too dark.
- **IR cut filter** - when set to off, the camera will be able to “see” infrared light, e.g. at night, thus making the image clearer. The image is shown in black & white when the IR cut filter is off. Set to **Auto** to automatically turn the filter off when the available visible light falls below the minimum requirement.

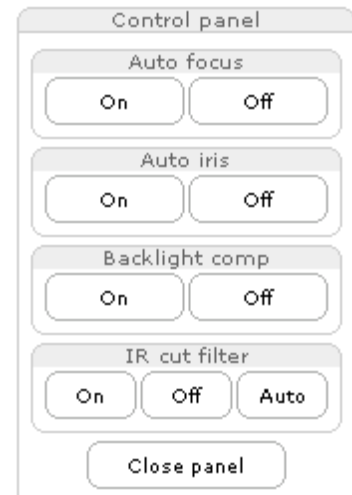







The control panel can also show custom shortcuts, which are configured from **PTZ Configuration > Advanced > Ctrl Panel**.

### Viewer controls

The default viewer to use for displaying moving images is selected from **Setup > Live View Config > Layout**.

The **AMC viewer toolbar** is available in Microsoft Internet Explorer only. See *AXIS Media Control*, on page 12 for more information. The AMC viewer toolbar displays the following buttons:

- 
 The **Play/Stop** buttons start and stop the live video stream.
- 
 The **Snapshot** button takes a snapshot of the currently displayed image. The Snapshot function and the target directory for saving snapshots can be configured from AMC (AXIS Media Control), which is available from the Windows Control Panel (Internet Explorer only).
- 
 Click the **View Full Screen** button and the video image will fill the entire screen area. No other windows will be visible. Press Esc (Escape) on the computer keyboard to cancel full screen view.
- 
 The record button is used to record the current (MPEG-4) video stream. The location where the image file is saved can be specified using the AMC control panel. To enable recording, Select **Live View Config > Viewer Settings > Enable recording button**.
- 
 These buttons change the navigation mode. Selecting **Center** will move the camera view to center on the position that was clicked. **Joystick** mode will move the camera in the direction indicated by a mouse click, relative to the center of the image. The further from the center the image is clicked, the greater the movement. These modes can also be selected by right-clicking in the image.
- 
 Click the **Speaker** and **Microphone** buttons to switch the sound off and on for the speaker and microphone, respectively.
- 
 When using **Half-duplex** mode this button toggles between allowing you to speak and listen. The first icon indicates that you can talk and the speaker attached to the camera will play your voice. The second indicates that you will hear audio from the camera, but no audio will be sent to web clients. When in **Simplex** talk mode, the icon toggles between allowing you to speak and is dimmed when you do not want other clients to receive any audio.



Use the slider to control the volume on the speaker and microphone. The volume can be set between 0 and 100.

**Area Zoom**

This allows you to draw a box over a desired area to zoom into. To activate, click the **Center** button described in the AMC viewer toolbar, or in other Internet browsers, select **PTZ > Center**. Using your mouse, click in the image and, while holding down the left mouse button, draw a square over the area you would like to zoom into.

This functionality may need to be calibrated before use. This is done from **Setup > PTZ Configuration > Advanced > Calibration**.

**Server push (not available for Microsoft Internet Explorer)**

With this method, the AXIS 214 PTZ maintains and controls an open HTTP connection to the browser and sends data as and when required, for as long as required.

**QuickTime**

For use with MPEG-4 only. Note that in the settings for **Video & Image > Advanced > MPEG-4**, the Video object type must be set to **Simple**.

**Java applet**

This alternative uses a Java applet to update the images in the browser. No download is required. Note that when this alternative is selected, external video sources will not be available on the live view page, and audio will be mono-directional only (to the client only).

**Still Image**

Displays still images only. Hit your browser's Refresh button to view a new image.

**PTZ Control Queue**

Only one user can use the Pan/Tilt/Zoom controls at any one time. When multiple users are accessing the AXIS 214 PTZ's Live View page, they must be placed in a queue and assigned a set period of time during which they have the use of the PTZ controls. Use the buttons to request or release control of the PTZ controls.

| PTZ Control Queue                              |   |
|--|---|
| Status in queue:                               | <input type="text" value="Not in queue"/> |
| Position in queue:                             | <input type="text"/>                      |
| Time remaining:                                | <input type="text"/> seconds              |
| <input type="button" value="Request control"/> |   |

The PTZ Control Queue is set up by the administrator from **PTZ Configuration > Control Queue**.

## Video and Audio Streams

The AXIS 214 PTZ provides several different image and video formats. The type to use depends on your requirements and on the properties of your network.

The Live View page in the AXIS 214 PTZ provides access to Motion JPEG and MPEG-4 video streams, as well as to single JPEG images. Other applications and clients can also access these video and audio streams/images directly, without going via the Live View page.

### Video Stream Types

#### Motion JPEG

This format uses standard JPEG still images in the video stream. These images are then displayed and updated at a rate sufficient to create a stream that shows constantly updated motion.

The Motion JPEG stream uses considerable amounts of bandwidth, but also provides excellent image quality and access to each and every individual image contained in the stream.

Note also that multiple clients accessing Motion JPEG streams can use different image settings.

#### MPEG-4

This is a video compression standard that makes good use of bandwidth, and which can provide high-quality video streams at less than 1 Mbit/s.

The MPEG-4 standard provides scope for a large range of different coding tools for use by various applications in different situations, and the AXIS 214 PTZ provides certain subsets of these tools. These are represented as **Video object types**, which are selected for use with different viewing clients. The supported video object types are:

- **Simple** - sets the coding type to H.263, as used by e.g. QuickTime™
- **Advanced Simple** - sets the coding type to MPEG-4 Part 2, as used by AMC (AXIS Media Control)

When using MPEG-4 it is also possible to control the bit rate, which in turn allows the amount of bandwidth usage to be controlled. CBR (constant bit rate) is used to achieve a specific bit rate by varying the quality of the MPEG-4 stream. When using VBR (variable bit rate), the quality of the video stream is kept as constant as possible, at the cost of a varying bit rate.

#### Notes:

- MPEG-4 is licensed technology. The AXIS 214 PTZ includes one viewing client license. Installing additional unlicensed copies of the viewing client is prohibited. To purchase additional licenses, contact your Axis reseller.
- All clients viewing the MPEG-4 stream must use the same image settings.

### Audio Stream Types

The audio stream types for audio are:

- **G.711** - International standard for encoding wired-telephone audio. Uses PCM samples to compress audio where higher signal values are compressed more than lower values. In Axis products, this sets the coding type to  $\mu$ -law 64 kbit/s.
- **G.726** - Uses PCM samples to code the difference between samples (ADPCM). Reduces bandwidth without losing too much useful audio. In Axis products, this sets the coded bit rate to 24 or 32 kbit/s.

All stream types are ITU-T standards and operate on frequencies of up to 4 kHz.

## MPEG-4 protocols and communication methods

To deliver live streaming video over IP networks, various combinations of transport protocols and broadcast methods are employed.

- RTP (Realtime Transport Protocol) is a protocol that allows programs to manage the real-time transmission of multimedia data, via unicast or multicast.
- RTSP (Real Time Streaming Protocol) serves as a control protocol, to negotiate which transport protocol to use for the stream. RTSP is thus used by a viewing client to start a unicast session, see below.
- UDP (User Datagram Protocol) is a communications protocol that offers limited service for exchanging data in a network that uses the Internet Protocol (IP). UDP is an alternative to the Transmission Control Protocol (TCP). The advantage of UDP is that it is not required to deliver all data and may drop network packets when there is e.g. network congestion. This is suitable for live video, as there is no point in re-transmitting old information that will not be displayed anyway.
- Unicasting is communication between a single sender and a single receiver over a network. This means that the video stream goes independently to each user, and each user gets their own stream. A benefit of unicasting is that if one stream fails, it only affects one user.
- Multicast is bandwidth-conserving technology that reduces bandwidth usage by simultaneously delivering a single stream of information to multiple network users. This technology is used primarily on delimited networks (intranets), as each user needs an uninterrupted data flow and should not rely on network routers.

## How to stream MPEG-4

Deciding on the combination of protocols and methods to use depends on your viewing requirements, and on the properties of your network. Setting the preferred method(s) is done in the control applet for AMC, which is found in the Windows Control Panel. When this has been set, AMC will test all the selected methods in the specified order, until the first functioning method is found.

### RTP+RTSP

This method (actually RTP over UDP and RTSP over TCP) should be your first consideration for live video, especially when it is important to always have an up-to-date video stream, even if some images do get dropped. This can be configured as multicast or unicast.

Multicasting provides the most efficient usage of bandwidth, especially when there are large numbers of clients viewing simultaneously. Note however, that a multicast broadcast cannot pass a network router unless the router is configured to allow this. It is thus not possible to multicast over e.g. the Internet.

Unicasting should be used for video-on-demand broadcasting, so that there is no video traffic on the network until a client connects and requests the stream. However, as more and more unicast clients connect, the traffic on the network will increase and may cause congestion. Although there is a maximum of 20 unicast viewers, note that all multicast users combined count as 1 unicast viewer.

### RTP/RTSP

This unicast method is RTP tunneled over RTSP. This can be used to exploit the fact that it is relatively simple to configure firewalls to allow RTSP traffic.

### RTP/RTSP/HTTP or RTP/RTSP/HTTPS

These two methods can also be used to traverse firewalls. Firewalls are commonly configured to allow the HTTP protocol, thus allowing RTP to be tunneled.

## AXIS Media Control

The recommended method of accessing live video (MPEG-4 and/or Motion JPEG) and audio from the AXIS 214 PTZ is to use the AXIS Media Control (AMC) in Microsoft Internet Explorer in Windows. This ActiveX component is automatically installed on first use, after which it can be configured by opening the AMC Control Panel applet from the Windows Control Panel. Alternatively, right-click the video image in Internet Explorer.

## Other methods of accessing the video stream

Video/images from the AXIS 214 PTZ can also be accessed in the following ways:

- If supported by the client, the AXIS 214 PTZ can use Motion JPEG server push to display video. This option maintains an open HTTP connection to the browser and sends data as and when required, for as long as required.
- As single JPEG images in a browser.  
Enter e.g. the path: `http://<IP address>/axis-cgi/jpg/image.cgi?resolution=CIF`
- Windows Media Player. This requires AMC and the MPEG-4 decoder to be installed. The paths that can be used are listed below, in the order of preference.
  - Unicast via RTP: `axrtpu://<IP address>/mpeg4/media.amp`
  - Unicast via RTSP: `axrtsp://<IP address>/mpeg4/media.amp`
  - Unicast via RTSP, tunneled via HTTP:  
`axrtsphhttp://<IP address>/mpeg4/media.amp`
  - Unicast via RTSP, tunneled via HTTPS:  
`axrtsphhttps://<IP address>/mpeg4/media.amp`
  - Multicast: `axrtpm://<IP address>/mpeg4/media.amp`

## Other MPEG-4 clients

Although it may be possible to use other clients to view the MPEG-4 stream, this is not guaranteed by Axis. For some other clients, e.g. QuickTime™ the Video Object Type must be set to *Simple*. It may also be necessary to adjust the advanced MPEG-4 settings. To assess the video stream from e.g. QuickTime™ the following path can be used:

`rtsp://<ip address>/mpeg4/media.amp`

This path is for all supported methods, and the client will negotiate with the AXIS 214 PTZ to determine exactly which transport protocol to use.

## Audio transmission methods

The audio stream can be accessed in the Live View page when viewing either Motion JPEG or MPEG.

### Using Motion JPEG

The basic transmission method of audio used in conjunction with Motion JPEG video streaming is transmission over HTTP. The video and audio streams are not synchronized when using Motion JPEG so the streams may be slightly out of sync. The latency in any stream should be low, but this will depend on the network infrastructure.

### Using MPEG-4

When using MPEG-4, audio is streamed using the same protocol as the video stream.

When audio is transmitted using MPEG-4, the Axis product sends synchronization information along with the streams to the client performing the synchronization.

Audio is streamed from the client to the server over HTTP when using both Motion JPEG and MPEG-4.

## Accessing the Audio Streams

In addition to accessing audio in the Live View page using AMC, audio from the camera can also be accessed in the following ways:

- HTTP-API - Read about accessing audio for the other protocols through the HTTP-API at <http://www.axis.com/techsup>
- QuickTime/Windows Media Player - these can be used to listen to the audio stream using the same methods as for accessing video streams.

## The Setup Tools

The AXIS 214 PTZ is configured from the setup tools, which are available from the link in the web interface. The setup tools can be used by:

- administrators, who have unrestricted access to all the Setup tools
  - operators, who have access to the Video & Image, Live View Config and Event Configuration settings
- See the section on *Security - Users*, on page 29 for more information on user access control.

### Accessing the setup tools from a browser

Follow the instructions below:

1. Start the browser and enter the IP address or host name of the AXIS 214 PTZ in the location/address field.
2. The Live View page is now displayed. Click **Setup** to display the Setup tools.

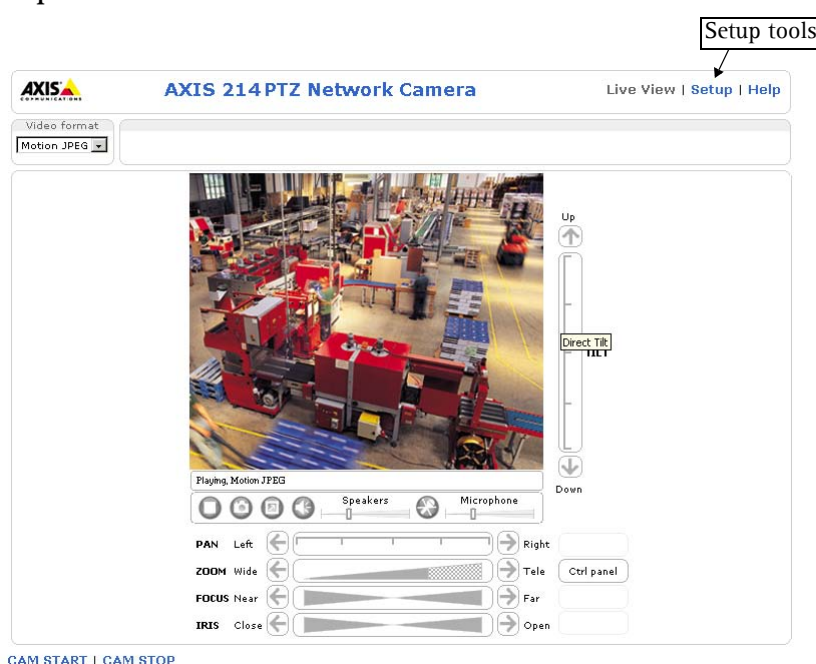

The descriptions on the following pages offer examples of the available features in the AXIS 214 PTZ. For full details of each setting, please refer to the online help files which are available from each page. Click  to access the help files.

# Video & Image settings

## Image

### Image Appearance

Adjust these settings to optimize the video images according to your requirements.

The screenshot shows the configuration interface for an AXIS 214 PTZ Network Camera. The main title is "AXIS 214 PTZ Network Camera" with "Live View | Setup | Help" links. The left sidebar contains navigation options: Basic Configuration, Video & Image (selected), Audio, Live View Config, PTZ Configuration, Event Configuration, System Options, and About. The "Image Settings" section is active, showing the following options:

- Image Appearance:**
  - Resolution:  Aspect ratio correction,  4CIF de-interlacing, CIF (352 x 288)
  - Compression: 30 [0..100]
  - Rotate image: 180 degrees
  - White balance: Auto
- Overlay Settings:**
  - Include overlay image at the coordinates: X 0 Y 0
  - Include date  Include time
  - Include text: [ ]
  - Text color: white Text background color: black
  - Place text/date/time at top of image
- Video Stream:**
  - Maximum video stream time:  Unlimited,  Limited to [ ] seconds per session
  - Maximum frame rate:  Unlimited,  Limited to [ ] fps per viewer
- Test:**
  - Test settings (using Motion JPEG) before saving. [Test]
  - [Save] [Reset]

All configuration of images and overlays will affect the performance of the camera, depending on usage and the available bandwidth.

Use these settings to adjust:

- **Image resolution** - select the image resolution to show on the Live View page.
- **Image compression** - increase compression to save on bandwidth
- **Image rotation** - rotate the image in steps of 90 degrees
- **White balance** - the white balancing system automatically detects white in the image and intelligently use this as a reference for other colors.

Please see the online help for more information on these settings.

**Note:** In certain situations, the white balancing system will not operate effectively. Problems may occur if the image contains no white color at all, or if the dominant color is not white. In these circumstances, the white balance may incorrectly be based on another visible color in the image, and colors may become distorted. A pale background picture with reddish or blue foreground objects is very symptomatic of this condition. In such cases it is recommended that a fixed white balance setting is selected.

### Overlay Settings

Use these settings to include  
 a) an image as an overlay, and/or  
 b) the date and time, along with text of your own.

Text overlays are all included on one line at the top or bottom of the video image. Image overlays can be placed anywhere in the video image.

See *Overlay Image*, on page 16 for instructions on how to upload an overlay image to the AXIS 214 PTZ.

### Video Stream

Define the maximum **video stream time** per session in seconds, minutes or hours. When the set time has expired, a new stream can be started by refreshing the page in the browser.

Define the maximum **frame rate** (fps - frames per second) allowed for each viewer, to avoid bandwidth problems on the network.

**Test** - For a preview of the image and overlay settings before saving, click **Test**. The Brightness setting does not affect the Test image. When satisfied with the settings, click **Save**. Please note that the preview image will be in JPEG format, even though the settings are valid both for Motion JPEG and MPEG-4.



### Overlay Image

An overlay image is an image included in the video image. Follow these instructions to upload and use an overlay image:

1. Go to **Setup > Video & Image > Overlay Image**.
2. To upload the image to the AXIS 214 PTZ, click the **Browse** button and locate it on your computer or server.
3. Click the **Upload** button and follow the on-screen instructions.
4. The image is now available in the **Use overlay image** drop-down list.
5. Click **Save**.
6. Go to **Setup > Video & Image** and modify the parameters under **Overlay Settings**.

#### Overlay image requirements:

| Image Formats  | Image Size  |
|--|---|
| <ul style="list-style-type: none"> <li>• Windows 24-bit BMP (full color)</li> <li>• Windows 4-bit BMP (16 colors)</li> </ul> | The height and width of the overlay image in pixels must be exactly divisible by 4. |

#### Overlay image requirements:

- The maximum overlay image size supported by the AXIS 214 PTZ is the same as the maximum image resolution. See *Technical Specifications*, on page 42.
- When a text overlay is also used, this reduces the amount of space available to the overlay image. To keep the text readable at lower resolutions, the text overlay occupies proportionally more and more space, i.e., 16 pixels in height at 640x480, 32 pixels at 320x240 and 64 pixels at 160x120.
- If the overlay is initially positioned so that part of it is outside the video image, it will be relocated so that it appears over the video image, i.e. it is always the entire image that is displayed.

Please see the online help for more information.



## Advanced Camera Settings

### Lighting Conditions

To optimize the lighting settings according to your requirements, modify the following settings:

- **Color setting** - select color or B/W.
- **Brightness** - this can be adjusted in the range 0-100.
- **Sharpness** - controls the amount of sharpening applied to the image.
- **IR cut filter** - turns the IR filter on or off. Alternatively, when set to Auto the filter will automatically be switched off when the light level falls below the minimum requirement.
- **Use backlight compensation** - this setting is used to make the subject appear clearer against e.g. a bright background.

Please see the online help for more information on these settings.

### Low Light Behavior

**Exposure control** - this setting is used to adapt to the amount/type of light being used. If set to **Manual**, select the desired Shutter speed from the drop-down list.

### Image Settings

**Auto focus enabled** (default setting) - this causes the camera to automatically adjust the focus to produce a sharp image. Setting the sensitivity to 'high' will cause a drop in the frame rate (fps).

## MPEG-4

Tools for adjusting the MPEG-4 settings and for controlling the video bit rate.

The screenshot shows the 'MPEG-4 Settings' page in the camera's web interface. The left sidebar contains navigation options: Basic Configuration, Video & Image (with sub-options for Image, Overlay Image, and Advanced Camera), Audio, Live View Config, PTZ Configuration, Event Configuration, System Options, and About. The main content area is titled 'MPEG-4 Settings' and includes a help icon. It is divided into several sections:
 

- Client Compatibility:** Video object type is set to 'Advanced Simple'. There is an unchecked checkbox for 'ISMA compliant'.
- GOV Settings:** Structure is set to 'IP'. Length is set to '20' with a range of '[1-150]'.
- Bit Rate Control:** Maximum bit rate is set to 'Unlimited'. There are radio buttons for 'Limited to' (with a text input field) and 'Unlimited'. Under 'Use:', 'Variable bit rate' is selected with a radio button, and 'Constant bit rate' is unselected. Target bit rate is set to '2000' kbit/s. Priority is set to 'None'.
- Video Stream:** Optimize the video stream for: is set to 'frame rate'.
- View Image Settings:** View image after saving. There is a 'View' button.

 At the bottom of the settings area, there are 'Save' and 'Reset' buttons.

The MPEG-4 standard provides many different coding tools for various applications in different situations. As most MPEG-4 clients do not support all of these tools, it is usual to instead define and use subsets for different clients or groups of clients. These settings allow you to define the type of viewing client to use.

Adjusting the maximum bit rate and setting it to variable or constant is a good way of controlling the bandwidth used by the MPEG-4 video stream. For more information on these advanced settings, please see *Video and Audio Streams*, on page 11, and the online help.

## AXIS Media Control

The AXIS Media Control (AMC) is installed automatically the first time the camera is accessed from a browser. The AMC control panel can be opened by right-clicking on the video image in the Live View web page. The AMC control panel can be used to configure various video and audio settings, such as push-to-talk. Please see the readme file included in the tool for more information.

# Audio

The AXIS 214 PTZ can transmit audio to other clients, by connecting a microphone, and can play audio from other clients by attaching a speaker.

This section describes how to configure the basic audio settings for the AXIS 214 PTZ, e.g. set the communication mode and adjust the sound levels for the microphone and speaker.

The screenshot shows the 'Audio Settings' page for an AXIS 214 PTZ Network Camera. The interface includes a navigation menu on the left with options like 'Basic Configuration', 'Video & Image', 'Audio', 'Live View Config', 'PTZ Configuration', 'Event Configuration', 'System Options', and 'About'. The main content area is titled 'Audio Settings' and contains the following sections:

- Enable Audio:** A checked checkbox labeled 'Enable audio'.
- Audio Channels:** A dropdown menu for 'Audio mode' set to 'Full duplex'. Below it is an unchecked checkbox for 'Send the sound from the active client to all other clients'.
- Audio Input:** A dropdown menu for 'Source' set to 'Microphone'. Below it is a dropdown menu for 'Input sensitivity' set to 'High'. A checked checkbox for 'Enable microphone power. If your microphone is dynamic or battery powered, this should be off.' is present. Below this are input fields for 'Input gain' (30 dB), 'Encoding' (G711 μ-law), 'Bit rate' (64 kbits/s), and 'Alarm level' (50 %).
- Audio Output:** A dropdown menu for 'Output gain' set to 30 dB.

A note at the bottom states: 'Note: The Java applet only supports G711 audio. QuickTime supports G711.' There are 'Save' and 'Reset' buttons at the bottom right.

**Note:** The speaker attached to the LINE OUT connector must have a built-in amplifier, which is available in e.g. some brands of PC speakers.

## Basic Audio Settings

### Enable Audio

Enables audio transmission to and from the AXIS 214 PTZ. Refer to *Connecting audio equipment*, on page 38 for more information.

### Audio Channels

There are two mono audio channels between the AXIS 214 PTZ and other clients, one for receiving audio and one for transmitting audio. Each audio channel can be turned on or off, which means that there are four **audio mode** options that can be used.

- **Full-duplex** audio is when you can transmit and receive audio (talk and listen) at the same time, as when having a telephone conversation. The only controls you may wish to use are the mute buttons to turn off the sound, and the level sliders for adjusting the input/output volume. This mode requires the client PC to have a sound card with support for full-duplex audio. If your available bandwidth is 0.2 Mbit/s or less, it is recommended that you use **Half-duplex** mode instead.
- **Half-duplex** mode also transmits and receives audio in both directions, but only in one direction at a time (with the help of the push-to-talk button). To speak, press and hold the button (check that the microphone is not muted). When finished speaking, release the button to receive audio. The push-to-talk button is configured from AMC. Half-Duplex mode is best if you only have limited bandwidth available.

- In **Simplex - AXIS 214 PTZ speaker only** mode, the speaker connected to the AXIS 214 PTZ will play audio, but no audio will be transmitted from the AXIS 214 PTZ to other web clients. This could be used to e.g. provide spoken instructions to a person viewed in the camera. This mode requires the use of the push-to-talk button.
- **Simplex - AXIS 214 PTZ microphone** mode transmits audio **only** from the microphone connected to the AXIS 214 PTZ to web clients. It will not receive audio from other web clients. This can be used in remote monitoring, web attractions etc., to provide live audio, as well as video, of a monitored situation.

When using half-duplex, the **Send the sound from the active client to all other clients** option transmits the audio signal from the client that is talking to all the other clients.

### Audio Input

Audio from an external microphone or a line source can be connected to the Line/Mic In socket of the AXIS 214 PTZ. The audio source can be set to **Microphone** or **Line**. If you are using a microphone, the **input sensitivity** can be set to **High** or **Low**. See *Technical Specifications*, on page 42 for the exact maximum levels.

The **Enable microphone power** option provides DC power for the external microphone. If you use a small electret condenser microphone such as a clip-on mic or a PC microphone, this option needs to be enabled.

To use a high impedance dynamic microphone, DC power should not be enabled. Using DC power will not harm the microphone. The default value is DC power enabled. To use a professional microphone requiring 48V phantom power, you need an external power supply and must use a balanced-unbalanced converter (audio transformer) in between.

If there are problems with the sound input being too low or high, adjust the input gain for the microphone attached to the AXIS 214 PTZ.

### Audio Output

If the sound from the speaker is too low or high it is possible to adjust the **output gain** for the active speaker attached to the AXIS 214 PTZ.

When satisfied with the settings, click **Save**, or click **Reset** to revert to the previously saved settings.

## Advanced Audio Settings

The **Advanced Audio** settings allow you to tune the external microphone connected to the AXIS 214 PTZ's connection module to suit your environment.

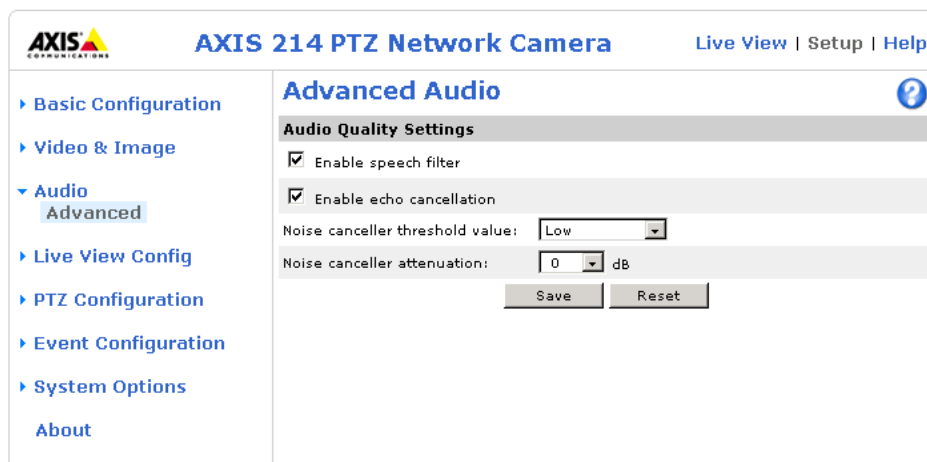

**Enable speech filter** improves the sound quality when the microphone is placed close to the person talking and can also help reduce background noise. The filter cuts the lowest and the highest frequencies. The bypass frequency range is approximately 250Hz to 3700Hz (measured at -10dB cut-off break points).

**Enable echo cancellation** reduces acoustic echoing (feedback) if sound from the speaker is captured by the microphone.

Noise cancellation is a way of reducing the background noise when there is no useful audio present. A typical application could be that the camera is set up in a noisy environment, and you are only interested in hearing the sound from the AXIS 214 PTZ when someone is speaking close to the microphone. There are two adjustable parameters available to optimize this function:

- **Noise canceller threshold value**
- **Noise canceller attenuation**

When the incoming sound is louder than the threshold, it will pass without any changes. When lower than the threshold, the incoming sound will be reduced by a certain attenuation factor. The threshold level should be set higher than the background noise, but lower than the useful audio.

The **noise canceller threshold value** can be set to **High, Medium High, Medium low** and **Low**. A lower threshold will allow most of the audio to pass. Only the weakest background noise will be reduced. A higher threshold will make noise cancellation act on even louder background noise. At the maximum level **High**, there is also a risk of reducing useful audio.

There is a trade-off between noise cancellation and sound quality. In other words, increasing the **noise canceller attenuation** deteriorates sound quality. Adjust the threshold and the attenuation to an optimum by listening and changing the levels.

# Live View Config

## Layout

These are the tools for deciding the layout of the Live View page. The layout can be set in 3 ways:

- Use Axis look - the layout is unchanged.
- Use custom settings - modify the default page with your own colors, images etc. Click the **Configure** button and see the following page.
- Own Home Page - Upload and use your own custom page as the default web page. Click the **Configure** button and see the following page.

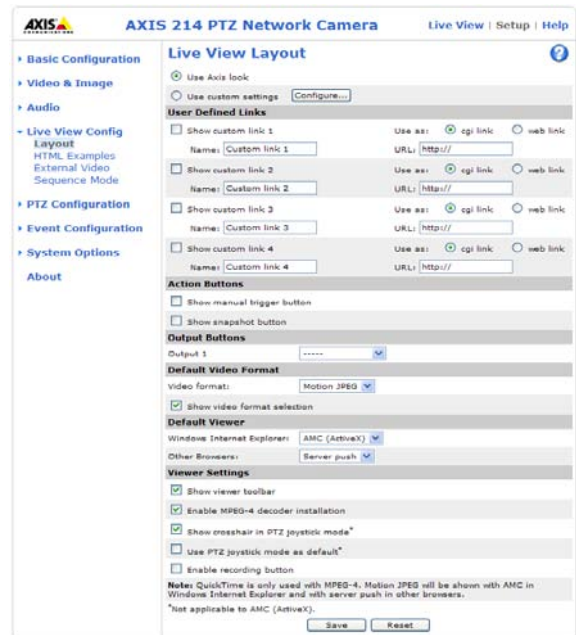

### Use custom settings

To change the background picture, banner, colors, etc., adjust the settings under **Modify the Axis look**.

To use your own file for e.g. a banner, first upload it (see the next page) or select **External** and enter the path to the file.

### Upload Own Web Files

Your own web files, background pictures etc., must first be uploaded to the AXIS 214 PTZ in order to be available for selection in the **Custom Settings setup** dialog. Once uploaded, the files are shown in the drop-down list.

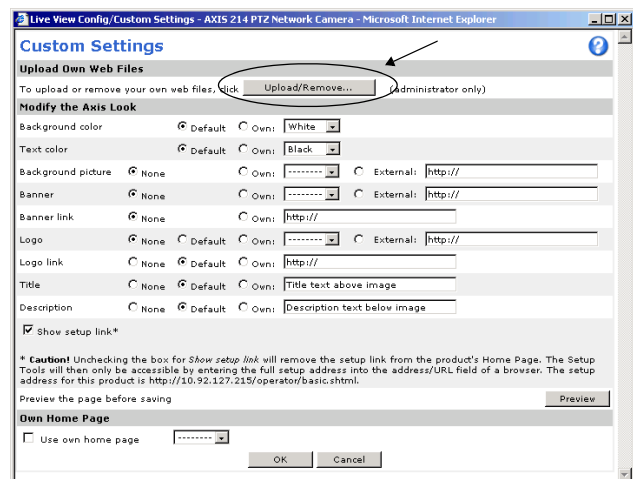

1. Enter the path to the file, e.g. a file located on your workstation or click the **Browse** button.
2. Select the user level for the uploaded file. Setting the user access level means that you have complete control over which pages can be viewed by which users.
3. When the path is shown correctly in the text field, click the **Upload** button.

All uploaded files are shown in the list in the lower section of the page. To remove a file, check the box provided next to it and then click the **Remove** button.

- To use your uploaded file, click the radio button and select the file from the drop-down list by **Own**:
- To use an external file located somewhere other than in the AXIS 214 PTZ, click the radio button and enter the URL by **External**.

**Note:** Unchecking the box for **Show setup link** removes the link from the camera's web pages. The setup tools will then only be accessible by entering the full setup address into the address/URL field of a browser, i.e. `http://<ip address>/operator/basic.shtml`

### Own Home Page

To use a previously uploaded web page as the default page, check the checkbox, select the page from the drop-down list and click OK.

### User Defined Links

Enter a descriptive name and enter the URL in the provided field. The link will appear on the Live View page.

User defined CGI links can be used to issue HTTP API requests, e.g. PTZ commands.

Example:

1. Check **Show custom link 1**.
2. Enter a descriptive name, e.g. CAM START.
3. Select the **Use as cgi link** radio button and enter the cgi link in the field:

```
http://192.168.0.125/axis-cgi/com/ptz.cgi?continuouspaniltmove=-30,-30
```

4. Check **Show custom link 2**.
5. Enter a descriptive name, e.g. CAM STOP.
6. Select the **Use as cgi link** radio button and enter the cgi link in the field:

```
http://192.168.0.125/axis-cgi/com/ptz.cgi?continuouspaniltmove=0,0
```

7. These links will appear in the web interface and can be used to control the PTZ camera.

For more information on the Axis HTTP API, see the Support / Developer pages on the Axis Website at <http://www.axis.com>

### Action Buttons

These buttons can then be used to manually trigger and stop an event from the Live View page. For more information, see *Event servers*, on page 25.

The snapshot button allows users to take a snapshot of the video stream and save it on a computer.

### Output Buttons

These buttons can then be used to manually start and stop an event from the Live View page, e.g. to switch a light on/off:

- The Pulse button activates the port for a defined period
- Active/Inactive displays 2 buttons, one for each action (on/off)

### Default Video Format

Select the default video format from the drop-down list. Check the box provided to enable video format selection on the Live View page.

### Default Viewer

Select the appropriate viewer to define the preferred method for viewing moving images in your browser.

### Viewer Settings

Check the **Show viewer toolbar** box to show the viewer toolbar under the image on the Live View page.

Uncheck the **Enable MPEG-4 decoder installation** checkbox disable the installation of the MPEG-4 decoder included with AMC.

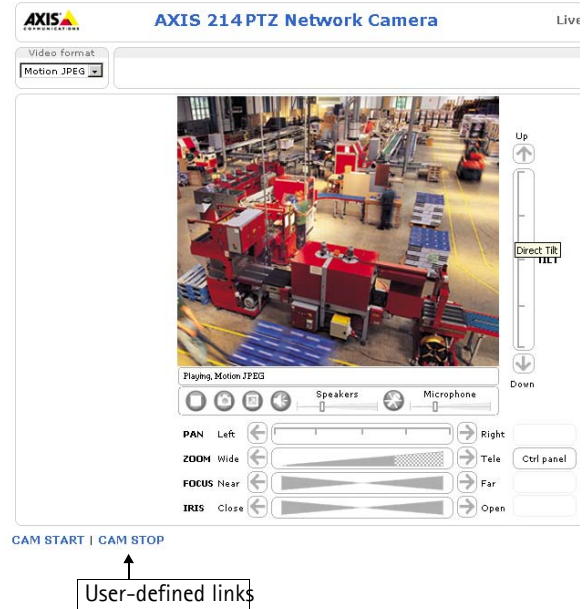

Check the **Show crosshair in PTZ joystick mode** box to show a red position indicator on the live view page when joystick navigation mode is selected.

**Use PTZ joystick mode as default** - Sets the PTZ mode to joystick, which can be changed temporarily on the PTZ Control Panel, but will default to joystick if this is selected.

**Enable recording button** - When enabled, clicking this button will start an MPEG-4 recording.

Please see the online help  for further details.

## HTML Examples

You can add live video from the AXIS 214 PTZ to your own web site. The camera can transmit a Motion JPEG or unicast MPEG-4 stream to up to 20 simultaneous connections, although an administrator can restrict this to fewer. If multicast MPEG-4 is used, the video stream will be available to an unlimited number of viewers connected to those parts of the network where multicast is enabled. Please note that a separate MPEG-4 license is required for each viewer.

Enter the **Video format**, **Image type**, **Image size** and other settings to suit your Web page and click **Update**. The camera then generates the required source code for your configuration. Copy this code and paste it into your own Web page code.

Please see the online help  for more information.

## External Video

The AXIS 214 PTZ can also display video images from other Axis network cameras and video servers, directly on the Live View page. These are known as **External Video sources**. Once configured, these external video sources are available from the drop-down list on the Live View page.

Click the **Add** button to open the External Video Source Setup dialog, which is used to make all the necessary settings. Enter the IP address or host name of the external video source you wish to add. Depending on the external source, select either MPEG-2, MPEG-4 or Motion JPEG as the type of video stream to receive.

## Sequence Mode

The Live View page can be configured to rotate through selected preset positions and/or external video sources, in a set order or randomly.

Select the desired preset positions/sources and enter the time to display each one for. Click **Save**.

 The Sequence buttons will appear on the Live View page, allowing the viewer to start and stop the sequence mode.

# PTZ Configuration

## Preset Positions

A preset position is a pre-defined camera view that can quickly and easily be viewed.

From **Preset Position Setup**, use the Pan, Tilt and Zoom (PTZ) controls to steer the camera to the required position. When satisfied with the camera's position, enter a descriptive name. This camera position is then saved as a preset position.

The AXIS 214 PTZ will take the exact position when the preset's name is selected from the Preset positions drop-down list. Preset positions can be selected in **Live View**, from events and in **Sequence mode**.

One position can be set as the **Home** position, which is readily accessible by clicking on the Home button in both the Preset Position Setup window and the Live View window.

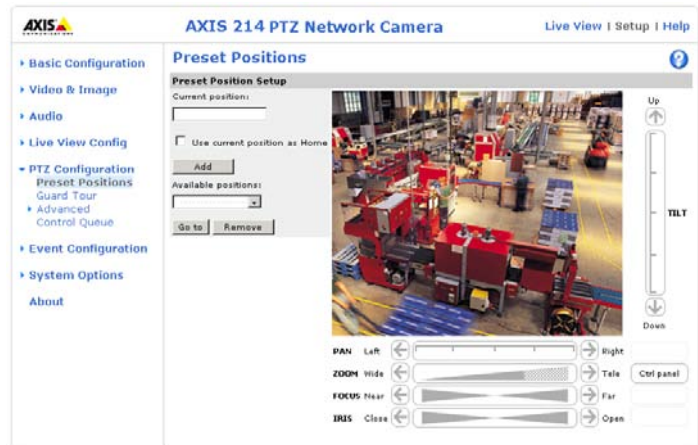

## Guard Tour

A guard tour displays different preset positions, one-by-one, in a pre-determined order or randomly, and for configurable time periods. Once the preset position has been set, and added to the guard tour, the following settings can be made:

- View Time in seconds or minutes
- Move Speed - sets the speed of the Pan/Tilt movements to the preset position
- View Order (or Random)

## Advanced - Limits

Define the **pan**, **tilt** and **zoom** limits for the AXIS 214 PTZ. Movements to the left and right, up and down can be restricted to narrow the area under surveillance. See the online help for further information.

## Advanced - Ctrl Panel

This allows you to add a shortcut command button to the control panel. This requires you to provide the URL (path) to an auxiliary command provided by the PTZ driver, or to some other command accessed via the HTTP API. See the online help for more information.

## Advanced - Calibration

The area zoom functionality available on the Live View page can be calibrated from here.

## Control Queue

**PTZ Control Queue** - The administrator can set up a queue for the PTZ controls. Once set up, the PTZ Control Queue buttons will appear on the Live View page offering one viewer exclusive control for a limited amount of time. Other users will be placed in the queue.



Please see the online help [?](#) for more information.



## Event configuration

This section describes how to configure the AXIS 214 PTZ for alarm and handling. The AXIS 214 PTZ can be configured to perform certain actions when certain types of events occur.

### Terminology

- **Event Type** - A set of parameters describing how and when the AXIS 214 PTZ should perform certain actions. An event type may result in a single *event*, or it may result in many, all depending on how often the conditions governing its behavior are met.
- **Triggered Event Type** - An event that is activated by a specific internal or external trigger condition. For example by motion detection or by an external device such as a door switch or a sensor.
- **Scheduled Event Type** - An event that runs at a pre-programmed time.
- **Action** - What occurs when the event triggers, e.g. the upload of video images to an FTP server, email notification, etc.

### Event servers

Event servers are used to e.g. receive uploaded image files and/or notification messages. To set up event server connections in your AXIS 214 PTZ, go to **Setup > Event Configuration > Event Servers**, and enter the required information for the selected server type.

| Server type | Purpose   | Required information   |
|-------------|---|--|
| FTP server  | <ul style="list-style-type: none"> <li>• Upload of saved images</li> </ul>                                  | <ul style="list-style-type: none"> <li>• IP address/hostname</li> <li>• Descriptive name of your choice</li> <li>• User name and password (to FTP server)</li> <li>• Upload path e.g. images/</li> <li>• Port number</li> <li>• Use passive mode if there is a firewall between the camera and the FTP server</li> </ul> |
| HTTP server | <ul style="list-style-type: none"> <li>• Notification messages</li> <li>• Upload of saved images</li> </ul> | <ul style="list-style-type: none"> <li>• Descriptive name of your choice</li> <li>• URL</li> <li>• User name and password (to HTTP server)</li> <li>• Proxy address/proxy port</li> <li>• Proxy user name and password</li> </ul>  |
| TCP server  |   | <ul style="list-style-type: none"> <li>• IP address/hostname</li> <li>• Descriptive name of your choice</li> <li>• Port number</li> </ul>  |

For details on each setting, please refer to the online help  available from each web page.

**Note:** Pre-trigger and post-trigger buffers will be lost if the connection to the event server fails.

When the setup is complete, the connection can be tested by clicking the **Test** button (the connection test will take approximately 10 seconds).

## Event types

An event type is a set of parameters describing how and when the AXIS 214 PTZ is to perform certain actions.

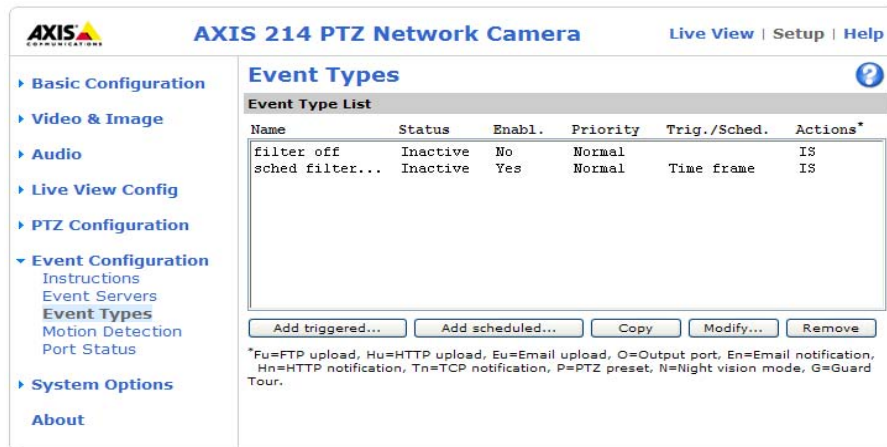

**Example:** If someone passes a connected sensor and an event type has been configured to act on this, the camera can e.g. record and save images to an FTP server, and/or send a notification email to a pre-configured email address with a pre-configured message. Images can be sent as email attachments.

## Triggered events

A triggered event is activated by e.g:

- a switch connected to an input port on the AXIS 214 PTZ
- a manual trigger, e.g. from an action button in the web interface
- on restart (reboot) after e.g. power loss
- an audio alarm.

### How to set up a triggered event

This example describes how to set the AXIS 214 PTZ to upload images when the main door is opened:

1. Click **Add triggered** on the Event types page.
2. Enter a descriptive **name** for the event, e.g. Main door.
3. Set the **Priority** - High, Normal or Low (see online help files).
4. Set the **Respond to Trigger...** parameters when the event is to be active, e.g. only after office hours.
5. Select the trigger alternative from the **Triggered by...** drop-down list, e.g. an Input port with a connected sensor if the door is opened.
6. Set the **When Triggered...** parameters, i.e. set the actions that the AXIS 214 PTZ will take if the main door is opened, e.g. upload images to an FTP server.
7. Click **OK** to save the event in the Event Types list.

Please see the online help  for descriptions of each available option.

### Pre-trigger and post-trigger buffers

This function is very useful when checking to see what happened immediately before and after a trigger, e.g. 2 minutes before and after a door has been opened. Check the **Upload images** checkbox under Event Types > Add triggered... > When Triggered... to expand the web page with the available options.

**Note:** Buffer size - up to 9 MB buffer. The maximum length of time of the pre-/post-buffer depends on the image size and selected frame rate.

**Include pre-trigger buffer** - images stored internally in the server from the time immediately preceding the trigger. Check the box to enable the pre-trigger buffer, enter the desired length of time and specify the required image frequency.

**Include post-trigger buffer** - contains images from the time immediately after the trigger. Configure as for pre-trigger.

**Note:** If the pre- or post-buffer is too large for the internal memory, the frame rate will be reduced and individual images may be missing. If this occurs, an entry will be created in the unit's log file.

**Continue image upload (unbuffered)** - enable the upload of images for a fixed length of time. Specify the length of time for the uploaded recording, in seconds, minutes or hours, or for as long as the trigger is active. Finally, set the desired image frequency to the maximum (the maximum available) or to a specified frame rate. The frame rate will be the best possible, but might not be as high as specified, especially if uploading via a slow connection.

## Scheduled events

A **Scheduled event** can be activated at preset times, in a repeating pattern on selected weekdays.

### How to set up a scheduled event

This example describes how to set the AXIS 214 PTZ to send an email notification with saved images from a set time:

1. Click **Add scheduled** on the **Event types** page.
2. Enter a descriptive **name** for the event, e.g. Scheduled email.
3. Set the **Priority** (High, Normal or Low).
4. Set the **Activation Time** parameters (24h clock) when the event is to be active, e.g. start on Fridays at 18.00 with a duration of 62 hours.
5. Set the **When Activated...** parameters i.e. set what the AXIS 214 PTZ is to do at the specified time e.g. send uploaded images to an email address.
6. Click **OK** to save the event in the Event Types list.

Please see the online help  for descriptions of each available option.

## Motion Detection

The AXIS 214 PTZ can be configured for motion detection. This feature is used to generate an alarm whenever movement starts (or stops) in the image. The AXIS 214 PTZ can use a maximum of 10 Include/Exclude windows.

- **Include** windows target specific areas within the image
- **Exclude** windows are areas to be ignored within the Include window

Once configured, the motion detection windows will appear in a list when motion detection is set to trigger an event. See *How to set up a triggered event* above.

**Notes:**

- Using the motion detection feature may decrease overall performance in the camera.
- Motion detection will not function while the lens is moving (i.e. pan, tilt, zoom)

### Configuring Motion Detection

With reference to the motion detection parameters in the table below, follow these instructions to create a motion detection window.

1. a) For AMC: Check the radio button **Configure Include Windows** to set the type of window. Click the **New** button. A new window called DefaultWindow appears over the image. Select the name in the list of windows and rename the window.  
  
 b) For the Java applet: Click the **Add Window** button. Check the radio button **Include** or **Exclude** to define the type of window. Select the tab for the window and rename the window.
2. To move the window to the area to monitor, click on the text at the top of the window and drag it to the desired location. The window can be re-sized by dragging the bottom-right corner.

3. Set the **Object Size**, **History**, and **Sensitivity** profile sliders for the window (only applies to Include windows). A full description of each profile slider is provided below.
4. To test the motion detection window, select it and then create some physical disturbance within the window area. Any detected motion is then indicated by colored peaks in the Activity Indicator. An alarm is only generated if the motion exceeds the tolerance defined by the black delimiter line and the peak turns red.
5. For the Java applet: Click the Save button to save the new window.

If there are parts of the Include window that you wish to exclude, create an **Exclude Window**. An Exclude window is named, sized and moved in the same way as an Include window, but no other configuration is necessary.

### Motion Detection Parameters

The parameters available for motion detection are described briefly here. Please see the online help for complete descriptions.

| Parameter      | Size   | History   | Sensitivity   |
|----------------|--|---|---|
| High           | Only very large objects trigger motion detection | An object that appears in the region will trigger the motion detection for a long period        | Ordinary colored objects against ordinary backgrounds will trigger the motion detection |
| Low            | Even very small objects trigger motion detection | An object that appears in the region will trigger motion detection for only a very short period | Only very bright objects against a dark background will trigger motion detection        |
| Default values | Low  | Medium to High  | Medium to High  |

#### Examples:

- Avoid triggering on small objects in the image by selecting a high size level.
- To trigger motion detection as long as there is activity in the area, select a high **history** level.
- To only detect flashing light, low sensitivity can be selected. In other cases, a high sensitivity level is recommended.

### Port Status

Under **Event Configuration > Port Status** there is a list that shows the status for the connected inputs and outputs of the AXIS 214 PTZ for the benefit of the Operator who cannot access the System Options section.

**Example:** If the Normal state for a push button connected to an input is set to **Inactive** - as long as the button is not pushed, the state will be inactive. If the button is pushed, the state of the input changes to **active**.

## System Options

---

### Security - Users

User access control is enabled by default, when the administrator sets the root password on the first access. Other users are authorized with user names and passwords, or the administrator can choose to allow anonymous viewer login to the Live View page, as described below.

Users - the user list displays the authorized users and access levels:

- **Viewer** - the lowest level of access, which only allows the user access to the Live View page.
- **Operator** - an Operator can view the Live View page, create and modify event types and adjust certain other settings. The Operator does not have access to the Systems Options configuration pages.
- **Administrator** - an administrator has unrestricted access to the Setup Tools and can determine the registration of all other users.

To add a new user, click the **Add...** button and see the online help.

User Settings - check the corresponding checkboxes to enable:

- **Enable anonymous viewer login** - allows any viewer direct access to the Live View page.
- **Maximum number of simultaneous viewers** - enter a value here to restrict the number of unicast viewers accessing the unit. This is useful if you need to save on bandwidth. (Note that all multicast viewers count as 1 viewer.)
- **Enable anonymous PTZ control login** - allows any viewer access to the Pan/Tilt/Zoom controls on the Live View page.

### Security - IP Address Filter

The administrator can add up to 256 IP address ranges or single IP addresses to the **Filtered IP Addresses** list. If IP address filtering is enabled, the AXIS 214 PTZ will allow or deny requests coming from the IP addresses in the list.

See the online help files  for information on how to add IP address ranges.

The IP addresses for the users added to this list need to be specified in the user list, with the appropriate access rights (**User**, **Operator** or **Administrator**).

**Referrals** - to prevent unauthorized sources from including the video stream from the AXIS 214 PTZ into external Web pages, check the **Referrals** checkbox and enter the IP address or Host name of the computer that hosts the Web pages with the included video stream. Several IP addresses/host names can be defined and are separated by semicolons(;

### Security - HTTPS

For greater security, the AXIS 214 PTZ can be configured to use HTTPS (Hypertext Transfer Protocol over SSL (Secure Socket Layer)). This means that all communication that would otherwise go via HTTP will instead go via an encrypted HTTPS connection.

To use HTTPS for communication with the AXIS 214 PTZ, a **Certificate** must be created using one of these methods:

- A self-signed certificate can be created in the camera, but this does not guarantee the same level of security as an official certificate.
- An official certificate issued by a CA (Certificate Authority). A CA issues and manages security credentials and public keys for message encryption.
  1. Click either **Create self-signed certificate** or **Create Certificate Request** and enter the required information in the provided fields.
  2. Click **OK**.

3. **Create self-signed certificate** generates and installs a certificate which will be displayed under **Installed Certificate**.  
**Create Certificate Request** generates a PEM formatted request which you copy and send to a CA for signing. When the signed certificate is returned, click **Install signed certificate...** to install the certificate in the AXIS 214 PTZ.
4. Set the **HTTPS Connection Policy** for the administrator, Operator and Viewer to enable HTTPS connection (set to HTTP by default).

Please refer to the home page of your preferred CA for information on where to send the request etc. For more information, please see the online help.

## Security - 802.1x

IEEE 802.1x is an IEEE standard for port-based Network Admission Control. It provides authentication to devices attached to a network port (wired or wireless), establishing a point-to-point connection, or, if authentication fails, preventing access on that port. 802.1x is based on EAP (Extensible Authentication Protocol).

In a 802.1x enabled network switch, clients equipped with the correct software can be authenticated and allowed or denied network access at the Ethernet level.

Clients and servers in an 802.1x network may need to authenticate each other by some means. In the Axis implementation this is done with the help of digital certificates provided by a **Certification Authority**. These are then validated by a third-party entity, such as a **RADIUS server**, examples of which are Free Radius and Microsoft Internet Authentication Service.

To perform the authentication, the RADIUS server uses various EAP methods/protocols, of which there are many. The one used in the Axis implementation is EAP-TLS (EAP-Transport Layer Security).

The AXIS network video device presents its certificate to the network switch, which in turn forwards this to the RADIUS server. The RADIUS server validates or rejects the certificate and responds to the switch, and sends its own certificate to the client for validation. The switch then allows or denies network access accordingly, on a preconfigured port.

### The authentication process

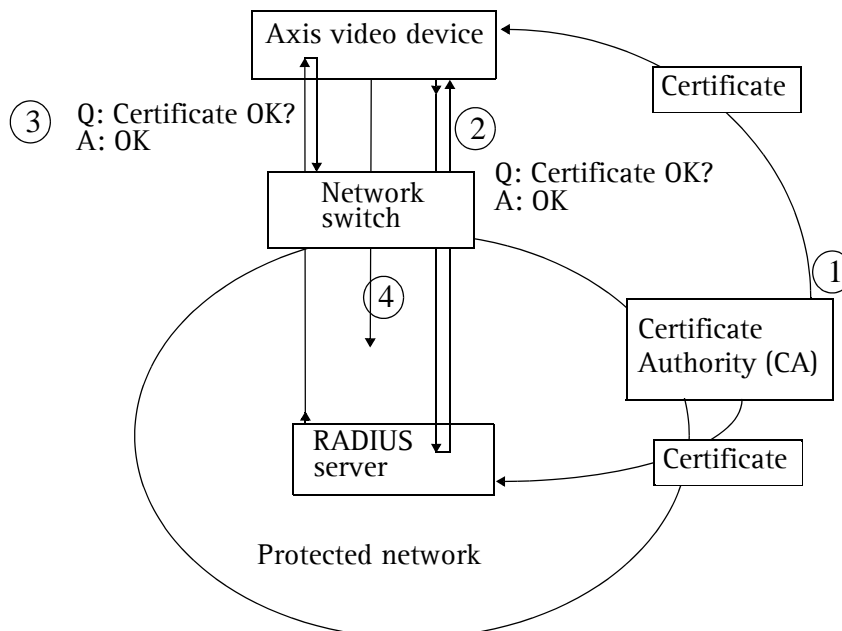

1. A CA server provides the required signed certificates.
2. The Axis video device requests access to the protected network at the network switch. The switch forwards the video device's CA certificate to the RADIUS server, which then replies to the switch.
3. The switch forwards the RADIUS server's CA certificate to the video device, which also replies to the switch.
4. The switch keeps track of all responses to the validation requests. If all certificates are validated, the Axis video device is allowed access to the protected network via a preconfigured port.

## RADIUS

RADIUS (Remote Authentication Dial In User Service) is an AAA (Authentication, Authorization and Accounting) protocol for applications such as network access or IP mobility. It is intended to work in both local and roaming situations.

## CA servers

In cryptography, a Certification Authority (CA) is an entity that provides signed digital certificates for use by other parties, and thus acts a trusted third party.

There are many commercial CA's that charge for their services. Institutions and governments may have their own CA, and there are free CA's available.

## Date & Time

**Current Server Time** - displays the current date and time (24h clock). The time can be displayed in 12h clock format in the Overlay Images (see below).

**New Server Time** - Select your time zone from the drop-down list. If you want the server clock to automatically adjust for daylight savings time, select **Automatically adjust for daylight saving time changes**.

From the **Time Mode** section, select the preferred method to use for setting the time:

- **Synchronize with computer time** - sets the time from the clock on your computer.
- **Synchronize with NTP Server** - the camera will obtain the time from an NTP server every 60 minutes. The NTP server's IP address or host name must be specified in the **TCP/IP Advanced Settings** - see page 33.
- **Set manually** - this option allows you to manually set the time and date.

**Note:** When using a host name for the NTP server, a DNS server must be configured under **TCP/IP** settings. See **Network > TCP/IP** below.

**Date & Time Format Used in Images** - specify the formats for the date and time (12h or 24h) displayed in the Live View video streams.

Use the predefined formats or use your own custom date and time formats. See **Advanced File Naming & Date/Time Formats** in the help files  for information on how to create your own file formats.

## Network - Basic TCP/IP Settings

### IP Address Configuration

Your Axis network camera supports both IP version 4 and IP version 6. Both versions may be enabled simultaneously, and at least one version must always be enabled.

When using IPv4, the IP address can be set automatically via DHCP, or a static IP address can be set manually.

If IPv6 is enabled, your camera will receive an IP address according to the configuration in the network router.

There are also options for setting up notification of changes in the IP address, and for using the AXIS Internet Dynamic DNS Service. For more information on setting the IP address, please see the online help.

- Notes:**
- To receive notification whenever the camera's IP address changes (via e.g. DHCP), configure the options for notification of IP address change. See **Services** below.
  - Alternatively, if your DHCP server can update a DNS server, you can access the AXIS 214 PTZ by host name which is always the same, regardless of the IP address.

### Services

**Enable ARP/Ping setting of IP address** - The IP address can be set using the ARP/Ping method, which associates the unit's MAC address with an IP address. Check this box to enable the service. Leave disabled to prevent unintentional resetting of the IP address.

- Notes:**
- The ARP/Ping service is automatically disabled 2 minutes after the unit is started, or as soon as an IP address is set.
  - Pinging the unit will still be possible when this service is disabled.



**Options for notification of IP address change** - Automatic IP address assignment via DHCP may lead to the situation where the IP address changes and you lose contact with the camera. To configure notification of changes in the IP address, click **Settings...** and enter the required information.

**AXIS Internet Dynamic DNS Service** - If the AXIS 214 PTZ has been registered with the Axis Internet Dynamic DNS service and the IP address for the product changes, the service is updated to reflect the change. Check the box to enable/disable automatic updates.

The domain name currently registered at the Axis Internet Dynamic DNS service for your product can be removed at any time. To do this, click **Settings...** and follow the instructions.

For more information, please refer to the online help.

## Network - Advanced TCP/IP Settings

### DNS Configuration

DNS (Domain Name Service) provides the translation of host names to IP addresses on your network.

**Obtain DNS server address via DHCP** - automatically use the DNS server settings provided by the DHCP server. Click the **View** button to see the current settings.

**Use the following DNS server address** - enter the desired DNS server by specifying the following:

- **Domain name** - enter the domain(s) to search for the host name used by the AXIS 214 PTZ. Multiple domains can be separated by semicolons (;). The host name is always the first part of a Fully Qualified Domain Name, e.g. myserver is the host name in the Fully Qualified Domain Name myserver.mycompany.com where mycompany.com is the Domain name.
- **Primary DNS server** - enter the IP address of the primary DNS server.
- **Secondary DNS server** - will be used if the primary DNS server is unavailable.

### NTP Configuration

The AXIS 214 PTZ can obtain the correct time from an NTP server. The address for the NTP server can either be obtained via the DHCP server, or it can be entered manually.

### Host Name Configuration

The AXIS 214 PTZ can be accessed using a host name, instead of an IP address. The host name is usually the same as the assigned DNS Name. It is always the first part of a Fully Qualified Domain Name and is always one word, with no period. For example, myserver is the host name in the Fully Qualified Domain Name myserver.mycompany.com.

Enabling dynamic DNS updates allows you to alias a dynamic IP address to a static host name, allowing your computer to be more easily accessed from various locations on the Internet. Outside users can always access your server using the associated DNS name regardless of the WAN IP. The DNS server used by the user and/or the DNS server responsible for the domain in use must support RFC2136 and allow updates from the camera.

The **TTL (Time To Live)** value determines how long (in seconds) the reply from the DNS server should be remembered when checking that the domain name for the registered IP address is still valid.

### Link-Local IPv4 Address

Link-Local Address is enabled by default and assigns the AXIS 214 PTZ with an additional IP address for the UPnP protocol. The AXIS 214 PTZ can have both a Link-Local IP and a static/DHCP IP address at the same time - these will not affect each other. See *Network - UPnP™*, on page 35.

### HTTP

The default HTTP port number (80) can be changed to any port within the range 1024-65535. This is useful for e.g. simple security port mapping.

## HTTPS

The default HTTPS port number (443) can be changed to any port within the range 1024-65535. HTTPS is used to provide encrypted web browsing.

### NAT Traversal (port mapping)

A broadband router allows devices on a private network (LAN) to share a single connection to the Internet. This is done by forwarding network traffic from the private network to the "outside" i.e. the Internet. Security on the private network (LAN) is increased since most broadband routers are pre-configured to stop any attempts to access the private network (LAN) from the public network/Internet.

Use NAT traversal when your AXIS 214 PTZ is located on an intranet (LAN) and you wish to make it available from the other (WAN) side of a NAT router. With NAT traversal properly configured, all HTTP traffic to an external HTTP port in the NAT router will be forwarded to the camera.

- Notes:**
- For NAT traversal to work, this must also be supported by the broadband router.
  - The broadband router has many different names: "NAT router", "Network router", "Internet Gateway", "Broadband sharing device" or "Home firewall" but the essential purpose of the device is the same.

**Enable/Disable** - When enabled, the AXIS 214 PTZ will attempt to configure port mapping in a NAT router on your network, using UPnP™. Note that UPnP™ must be enabled in the camera (see **System Options > Network > UPnP**).

**Use manually selected NAT router** - Select this option to manually select a NAT router and enter the IP address for the router in the field provided.

If a router is not manually specified, the AXIS 214 PTZ will automatically search for NAT routers on your network. If more than one router is found, the default router will be selected.

**Alternative HTTP port** - Select this option to manually define an external HTTP port. Enter the port number in the field provided. If no port number is entered here, a number will automatically be selected when NAT traversal is enabled.

- Notes:**
- An alternative HTTP port number can be used/be active even if NAT traversal is disabled. This is useful if e.g. your NAT router does not support UPnP and you need to manually configure port forwarding in the NAT router.
  - If you attempt to manually enter a port number that is already in use, another available port number will automatically be selected.
  - When the port number is selected automatically it will be displayed in this field. This can be changed by entering a new port number and clicking **Save**.

## FTP

The FTP server running in the AXIS 214 PTZ enables the upload of e.g. new firmware, user applications, etc. Check the box to enable the service.

## RTSP

The RTSP protocol allows a connecting client to start an MPEG-4 stream. Enter the RTSP port number to use. The default setting is 554.

### Network Traffic

The default connection setting is **Auto-negotiate**, which means that the correct speed is automatically selected. If necessary, you can set the connection speed by selecting it from the drop-down list. 10BaseT (Half/Full Duplex), 100BaseTX (Half/Full Duplex).

**Maximum bandwidth** - Specify, in Mbit/s or Kbit/s, the maximum bandwidth that the AXIS 214 PTZ is allowed to use on your network. This is a useful function when connecting the AXIS 214 PTZ to busy or heavily loaded networks. The default setting is **Unlimited**. For more information, please refer to the online help.

## Network - SOCKS

SOCKS is a networking proxy protocol. The AXIS 214 PTZ can be configured to use a SOCKS server to reach networks on the other side of a firewall/proxy server. This functionality is useful if the AXIS 214 PTZ is located on a local network behind a firewall, but notifications, uploads, alarms, etc., need to be sent to a destination outside the local network (e.g. to the Internet).

## Network - QoS (Quality of service)

Quality of Service (QoS) provides the means to guarantee a certain level of a specified resource to selected traffic on a network. Quality can be defined as e.g. a maintained level of bandwidth, low latency, no packet losses, etc. The main benefits of a QoS-aware network can be summarized as:

- the ability to prioritize traffic and thus allow critical flows to be served before flows with lesser priority.
- greater reliability in the network, thanks to the control of the amount of bandwidth an application may use, and thus control over bandwidth races between applications.

The QoS in Axis network video products marks the data packets for various types of network traffic originating from the product. This makes it possible for network routers and switches to e.g. reserve a fixed amount of bandwidth for these types of traffic. The following types of traffic are marked:

- live video
- live audio
- event/alarm traffic
- management network traffic.

### QoS Settings

For each type of network traffic supported by your Axis network video product, enter a DSCP (Differentiated Services Codepoint) value. This value is used to mark the traffic's IP header. When the marked traffic reaches a network router or switch, the DSCP value in the IP header tells the router or switch which type of treatment to apply to this type of traffic, for example, how much bandwidth to reserve for it.

Note that DSCP values can be entered in decimal or hexadecimal form, but saved values are always shown in decimal.

For more information on Quality of Service, please see the Axis support web at [www.axis.com/techsup](http://www.axis.com/techsup)

## Network - SMTP (email)

Enter the host names or addresses for your primary and secondary mail servers in the fields provided to enable event and error email messages from the AXIS 214 PTZ to predefined addresses via SMTP (Simple Mail Transfer Protocol).

## Network - SNMP

The Simple Network Management Protocol (SNMP) allows the remote management of network devices. The AXIS 214 PTZ can be configured to support SNMP. See the online help.

## Network - UPnP™

The AXIS 214 PTZ includes support for UPnP™ in Windows Me and Windows XP. Enabled by default.

**Note:** UPnP™ must be installed on your workstation. To do this, open the Control Panel from the **Start Menu** and select **Add/Remove Programs**. Select **Add/Remove Windows Components** and open the **Networking Services** section. Click **Details** and then select **UPnP** as the service to add.

## Network - RTP / MPEG-4

These settings are for the IP addresses, port numbers, and Time-To-Live values to use for media streams in the MPEG-4 format. Only certain IP addresses and port numbers should be used for these streams. For more information, please see the online help.

## Network - Bonjour

Your Axis network camera includes support for Bonjour. When enabled, the camera is automatically detected by operating systems and clients that support this protocol.

## Ports & Devices - I/O Ports

The pinout, interface support and the control and monitoring functions are described in the section *Connections*, on page 38.

## Maintenance

- **Restart** - The unit is restarted without changing any of the settings. Use this method if the unit is not behaving as expected.
- **Restore** - The unit is restarted and most current settings are reset to factory default values. The settings that will not be reset are as follows:
  - the boot protocol (DHCP or static)
  - the static IP address
  - the default router
  - the subnet mask
  - the system time.
- **Default** - The Factory default button should be used with caution. Pressing this button will reset all of the AXIS 214 PTZ's settings to the factory default values (including the IP address).

**Upgrade Server** - See *Updating the Firmware*, on page 39.

**Backup** - click the **Backup** button to take a backup of all of the parameters, and any user-defined scripts. If necessary, it is then possible to return to the previous settings if the settings are changed and there is unexpected behavior.

**Note:** The root password will also be reset to the password saved in the backup file.

**Restore** - click the **Browse** button to locate the saved backup file (see above) and then click the **Restore** button. The settings will be restored to the previous configuration.

**Note:** Backup and Restore can only be used on the same unit running the same firmware. This feature is not intended for multi-unit configuration or for firmware upgrades.

## Support

- **Support overview** - This page provides information on troubleshooting and contact information, should you require technical assistance.
- **System Overview** - This page provides an overview of the camera's settings and the most recent log entries with links to the corresponding pages.
- **Logs & Reports** - The various logs and the **Parameter List** provide valuable information for troubleshooting and when contacting the Axis support service. Please be sure to always provide a **Server Report** with your support query.
- **Configuration** - Select the required log level to save.
  - **Log Level for Log Files** - from the drop-down list, select the level of information to be added to the log file.
  - **Log Level for Email** - from the drop-down list, select the level of information to send as email and enter the destination email address.

## Advanced

**Scripting** - this is a powerful and advanced function that enables the use of custom scripts.

### Caution!

Improper use may cause unexpected behavior or even cause loss of contact with the unit. If a script does cause problems, reset the unit to its factory default settings. A backup file may be of use to return the unit to its latest configuration.

Axis strongly recommends that you **do not use this function** unless you fully understand the consequences. Axis support does not provide assistance for problems with customized scripts.

For more information, please visit the Developer pages at [www.axis.com/developer](http://www.axis.com/developer)

**Plain Config** - this function is for the advanced user with experience of Axis network camera configuration. All parameters can be set and modified from this page. Help is available from the standard help pages.

## Resetting to the factory default settings

To reset the AXIS 214 PTZ to the original default settings, go to the **System Options > Maintenance** web page (described in *Maintenance*, on page 36) or use the **Control** button on the rear panel of the AXIS 214 PTZ, as described below:

### Using the Control Button

Follow the instructions below to reset the AXIS 214 PTZ to the factory default settings using the Control Button.

1. Switch off the AXIS 214 PTZ by disconnecting the external power supply.
2. Using a suitably pointed object, press and hold the Control button while reconnecting the power connector.
3. Keep the Control button pressed for approximately 15 seconds.
4. Release the Control button.

**Note:** Resetting to the factory default settings using the Control Button will cause all parameters (including the IP address) to be reset. Refer to *Maintenance*, on page 36 for other methods that do not reset the IP address.

## Connections

### I/O inputs and outputs

The 4-pin I/O terminal connector provides the interface to:

- 1 transistor output
- 1 digital input
- auxiliary power and ground

The I/O terminal connector is used in applications for e.g. motion detection, event triggering, time lapse recording, alarm notification via email, image storage to FTP locations, etc.

- **Input** - for connecting e.g. a push button. If the push button is pressed, the state changes and the input becomes active (shown under **Event Configuration > Port Status**).
- **Output** - connects e.g. an alarm device that can be activated by Output buttons on the **Live View** page, or by an **Event Type**. The output will show as active (**Event Configuration > Port Status**) if the alarm device is activated.

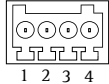
| Function                                 | Pin no. | Description   | Pinouts  |
|--|---------|---|--|
| Transistor Output                        | Pin 4   | With a maximum load of 100mA and a maximum voltage of 24V DC, this output has an open-collector NPN transistor with the emitter connected to the GND pin. If used with an external relay, a diode must be connected in parallel with the load, for protection against voltage transients. | The I/O terminal pins on the cameras are numbered left to right, as shown here.<br> |
| Digital Input                            | Pin 3   | Connect to GND to activate, or leave floating (or unconnected) to deactivate.   |  |
| GND                                      | Pin 2   | Ground  |  |
| Auxiliary DC Power Input (12VDC min 12W) | Pin 1   | Connected electrically in parallel with the power adapter, this pin provides an auxiliary connector for mains power to the unit. It can also be used to power auxiliary equipment, max 50mA.  |  |

### Schematic connection diagram

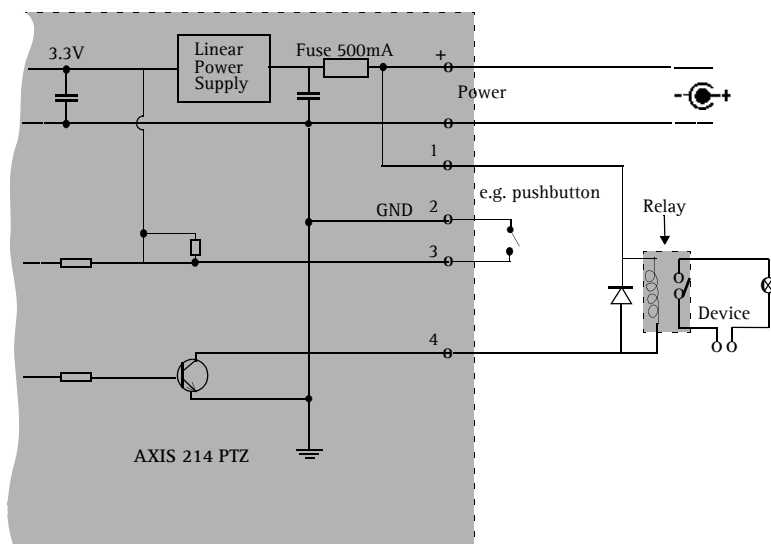

### Connecting audio equipment

1. Connect a microphone (not supplied) to the **LINE/MIC IN** socket.
2. Connect a loudspeaker (not supplied) to the **LINE OUT** socket (amplified speakers only).

# Troubleshooting

## Checking the Firmware

Firmware is software that determines the functionality of the AXIS 214 PTZ. When the firmware is upgraded, your Axis product receives the latest available functionality.

One of your first actions when troubleshooting a problem should be to check the currently installed firmware version. The latest version may contain a correction that fixes your particular problem. The current firmware version in your AXIS 214 PTZ is available under **Setup > Basic Configuration**.

## Updating the Firmware

New firmware can be downloaded to the cameras over the network. Always read the upgrade instructions available with each new release, before updating the firmware.

1. Save the firmware file to your computer. The latest version is available free of charge from the Axis Website at <http://www.axis.com/techsup> or from your local distributor.
2. Go to **Setup > System Options > Maintenance** in the AXIS 214 PTZ Web pages.
3. In the **Upgrade Server** section and browse to the firmware file on your computer. Click **Upgrade**.
4. Wait at least 20 minutes before restarting the AXIS 214 PTZ after upgrading.

- Notes:**
- Pre-configured and customized settings will be retained for use when the new firmware is running (providing that the features are available in the new firmware) although this is not guaranteed by Axis Communications.
  - After starting the process, you should always wait at least 20 minutes before restarting the AXIS 214 PTZ, even if you suspect the procedure has failed.
  - Your dealer reserves the right to charge for any repair attributable to faulty updating by the user.

## Support

If you contact the Axis support desk, please help us resolve your problems by providing a server report, a log file and a brief description of the problem.

**Server Report** - go to **Setup > System Options > Support Overview**. The server report contains important information about the server and its software, as well as a list of the current parameters.

**Log file** - go to **Setup > System Options > Logs & Reports**. The Log file records events within the unit since the last restart of the system and can prove a useful diagnostic tool for troubleshooting.

The screenshot shows the web interface for an AXIS 214 PTZ Network Camera. At the top, there is a navigation bar with the Axis logo, the title "AXIS 214 PTZ Network Camera", and links for "Live View", "Setup", and "Help". On the left side, there is a sidebar menu with categories like "Basic Configuration", "Video & Image", "Audio", "Live View Config", "PTZ Configuration", "Event Configuration", "System Options" (with sub-items: Security, Date & Time, Network, Ports & Devices, Maintenance, Support), and "About". The "Support" sub-item is expanded to show "Support Overview", "System Overview", "Logs & Reports", and "Advanced". The "Support Overview" page is active, displaying the following content:

**Support Overview**

**Troubleshooting**  
If you have problems, please try the troubleshooting [guide](#) before contacting your local supplier.

**Server Report**  
Always attach the [Server Report](#) when contacting your support channel.

**Axis Support Services**  
Should you require any technical assistance, please contact your [Axis reseller](#). If your questions cannot be answered immediately, your reseller will forward your queries through the appropriate channels to ensure a rapid response.

If you are connected to the Internet, you can:

- Download user documentation and firmware updates
- Find answers to resolved problems in the FAQ database. Search by product, category, or phrases
- Report problems to Axis support staff by logging in to your private support area

Visit the Axis Support Web at [www.axis.com/techsup/](http://www.axis.com/techsup/)

## Symptoms, Possible Causes and Remedial Actions

| Problems setting the IP address   |   |
|---|---|
| Using ARP and Ping  | The IP address must be set within two minutes after the power has been applied to the AXIS 214 PTZ. Restart the server and try again. Also, make sure the ping length is set to 408.  |
| The AXIS 214 PTZ is located on a different subnet   | If the IP address intended for the AXIS 214 PTZ and the IP address of your computer are located on different subnets, you will not be able to set the IP address. Contact your network administrator for an IP address on the same subnet as the computer you are performing the installation from.   |
| The IP address is being used by another device  | Disconnect power from the AXIS 214 PTZ.<br>Run the command (in a Command/DOS window, type <b>ping</b> and the <b>IP address</b> of the unit).<br><br>If you receive: <b>Reply from &lt;IP address&gt;: bytes = 32; time = 10 ms.....</b> - this means that the IP address may already be in use by another device on your network. You must obtain a new IP address and reinstall the unit.<br><br>If you receive: <b>Request timed out</b> - this means that the IP address is available for use with your AXIS 214 PTZ. In this case, check all cabling and reinstall the unit.   |
| The AXIS 214 PTZ cannot be accessed from a browser  |   |
| The IP address has been changed by DHCP   | 1) Move the AXIS 214 PTZ to an isolated network or to one with no DHCP or BOOTP server. Set the IP address again, using the ARP command.<br>2) Access the unit and disable BOOTP and DHCP in the TCP/IP settings. Return the unit to the main network. The unit now has a fixed IP address that will not change.<br>3) As an alternative to 2), if a dynamic IP address via DHCP or BOOTP is required, select the required service and then configure IP address change notification from the network settings. Return the unit to the main network. The unit will now have a dynamic IP address, but will notify you if the address changes. |
| Other networking problems   | Test the network cable by connecting it to another network device. Then ping that device from your workstation.   |
| Cannot send notifications, uploads, alarms, etc, to a destination outside the local network |   |
| Firewall protection   | The AXIS 214 PTZ can be configured to use a SOCKS server to reach networks on the other side of a firewall/proxy server.  |
| Your AXIS 214 PTZ is accessible locally, but not externally                                 |   |
| Firewall protection   | Check the Internet firewall with your system administrator.   |
| Default routers required  | Check if you need to configure the default router settings.   |
| A firmware upgrade has been interrupted or the firmware has in some other way been damaged  | A rescue firmware is running in the product. First, set the IP address using AXIS IP utility or ARP and Ping.<br><br>Then, from a Web browser, access the unit and download the latest firmware to the product, see <i>Updating the Firmware</i> , on page 39.  |
| Problems with the MPEG-4 format   |   |
| No MPEG-4 displayed in the client.  | Check that the correct network interface is selected in the AMC control panel applet (network tab).   |
|   | Check that the relevant MPEG-4 connection methods are enabled in the AMC control panel applet (network tab).  |
|   | In the AMC control applet, select the MPEG-4 tab and click the button Set to default MPEG-4 decoder.  |
| No multicast MPEG-4 displayed in the client   | Check with your network administrator that the multicast addresses used by the AXIS 214 PTZ are valid for your network.   |
|   | Check with your network administrator to see if there is a firewall preventing viewing.   |
| Multicast MPEG-4 only accessible by local clients   | Check if your router supports multicasting, or if the router settings between the client and the server need to be configured. The TTL (Time To Live) value may need to be increased.   |
| Poor rendering of MPEG-4 images   | Color depth set incorrectly on clients. Set to 16-bit or 32-bit color.  |
|   | If text overlays are blurred, or if there are other rendering problems, you may need to enable Advanced Video Rendering from the MPEG-4 tab in the AMC control panel applet.  |
|   | Ensure that your graphics card is using the latest device driver. The latest drivers can usually be downloaded from the manufacturer's website.   |
| Color saturation is different in MPEG-4 and Motion JPEG                                     | Modify the settings for your graphics adapter. Please see the adapter's documentation for more information.   |
| Lower frame rate than expected  | Reduce number of applications running on the client computer.   |
|   | Check with the system administrator that there is enough bandwidth available. See also the online help.   |
|   | Check in the AMC control panel applet (MPEG-4 tab) that video processing is not set to <b>Decode only I frames</b> .  |
|   | Lower the image resolution.   |
| Image degeneration  | Decrease the GOV length, see the online help for more information.  |
| No images displayed in the Web interface  |   |
| Problem with AMC ( <i>Internet Explorer only</i> )  | To enable the updating of images in Microsoft Internet Explorer, set your Web browser to allow ActiveX controls. Also, make sure that AXIS Media Control (AMC) component is installed on your workstation.  |
| Installation of additional ActiveX component restricted or prohibited                       | Configure your AXIS 214 PTZ to use a Java applet for updating the images under Live View Config > Layout > Default Viewer for Internet Explorer. See help files for more information.   |
| Video Image Problems  |   |
| Image too dark or too light   | See the help on Video & Image Settings.   |
| Problems uploading own files  | There is only limited space available for the upload of your own files. Try deleting one or more existing files, to free up space.  |
| Missing images in uploads   | This can occur when trying to use a larger image buffer than is actually available. Try lowering the frame rate or the upload period.   |



|  |  |
|--|--|
| Slow image update                                    | Configuring, e.g. pre-buffers, hi-res images, high frame rate etc will reduce the performance of the AXIS 214 PTZ.   |
| Slow performance                                     | Slow performance may be caused by e.g. heavy network traffic, many users with access to unit, low performing client, use of features such as event handling and image rotation.  |
| <b>Bad snapshot images</b>                           |  |
| Display incorrectly configured on your workstation   | In Display Properties, configure your display to show at least 65000 colors, i.e. at least 16-bit.<br>Using only 16 or 256 colors on your display will produce dithering artifacts in the image.   |
| <b>Audio problems</b>                                |  |
| No audio   | Check that: <ul style="list-style-type: none"> <li>• PC sound card, speakers and microphone are correctly connected.</li> <li>• The Mute button is not pressed.</li> <li>• The volume in and volume out settings are correct.</li> <li>• All cabling is connected.</li> <li>• The value of the Post Content Length in your proxy server is 1MB or more. You may need to contact your system administrator to do this.</li> </ul> |
| No full-duplex function                              | Incorrect configuration. Check the setting in the camera's Setup pages.<br>Sound card does not support full-duplex. For information on how to check if your sound card supports full-duplex, please visit <a href="http://www.axis.com">www.axis.com</a> and see the support section for Axis camera products.   |
| Poor performance                                     | Too many users/clients connected. Try limiting the number of clients allowed to connect.<br>Low bandwidth. Reduce the Speed setting on the Audio settings page. Setting lower speed will reduce any break-up in the sound, but will also increase the transmission delay. If running in Full-Duplex mode, try switching to Half-Duplex mode.   |
| Whining or screeching sound from speakers (feedback) | Poor positioning of speakers and/or microphone. Relocate the speakers or microphone so that they do not point towards each other, and/or lower the volume.   |

For further assistance, please contact your reseller or check the product's support pages on the Axis Website at <http://www.axis.com/techsup>

# Technical Specifications

| Item                       | Specification   |
|----------------------------|---|
| Models                     | <ul style="list-style-type: none"> <li>• AXIS 214 PTZ 50Hz (PAL)</li> <li>• AXIS 214 PTZ 60Hz (NTSC)</li> </ul>   |
| Image sensor               | 1/4" Sony Exview HAD CCD  |
| Lens                       | <ul style="list-style-type: none"> <li>• 4.1-73.8 mm</li> <li>• F1.4-3.0</li> <li>• Autofocus</li> <li>• Auto day/night</li> <li>• Focus range: 10mm (wide) or 800 mm (tele) to infinity</li> </ul>   |
| Angle of view              | Horizontal 2.7°-48°   |
| Zoom                       | 18x optical, 12x digital  |
| Minimum illumination       | <ul style="list-style-type: none"> <li>• Color mode: 0.3 lux at F1.4, 30IRE</li> <li>• Black/white mode: 0.005 lux at F1.4, 30IRE</li> </ul>  |
| Pan range                  | +/- 170°  |
| Tilt range                 | -30° to +90°  |
| Max speed                  | <ul style="list-style-type: none"> <li>• Pan: 100°/sec</li> <li>• Tilt: 90°/sec</li> </ul>  |
| Video compression          | <ul style="list-style-type: none"> <li>• Motion JPEG</li> <li>• MPEG-4 Part 2 (ISO/IEC 14496-2), Profiles: ASP and SP</li> </ul>  |
| Resolutions                | <ul style="list-style-type: none"> <li>• 4CIF, 2CIFExp, 2CIF, CIF, QCIF</li> <li>• max 704x480 (NTSC) 704x576 (PAL)</li> <li>• min 160x120 (NTSC) 176x144 (PAL)</li> </ul>  |
| Frame rate (NTSC/PAL)      | <ul style="list-style-type: none"> <li>• Motion JPEG: Up to 30/25 fps in all resolutions</li> <li>• MPEG-4: Up to 25/21 fps at 4CIF/2CIFExp, up to 30/25 fps at 2CIF/CIF/QCIF</li> </ul>  |
| Video streaming            | <ul style="list-style-type: none"> <li>• Simultaneous Motion JPEG and MPEG-4</li> <li>• Controllable frame rate and bandwidth</li> <li>• Constant and variable bit rate (MPEG-4)</li> </ul>   |
| Image settings             | <ul style="list-style-type: none"> <li>• Compression levels: 11 (Motion JPEG) /23 (MPEG-4)</li> <li>• Rotation: 90°, 180°, 270°</li> <li>• Backlight compensation</li> <li>• Configurable IR cut filter, Auto/Day/Night</li> <li>• Configurable white balance, color/BW, brightness, sharpness, exposure control</li> <li>• Overlay capabilities: time, date, text or image</li> <li>• Aspect ratio correction</li> <li>• De-interlace filter (4 CIF resolution)</li> </ul> |
| Pan/Tilt/Zoom              | <ul style="list-style-type: none"> <li>• 20 preset positions</li> <li>• Guard tour</li> <li>• Sequence mode</li> <li>• Control queue</li> <li>• Supports Windows compatible joysticks</li> <li>• Designed for operator control</li> </ul>   |
| Shutter time               | 1 to 1/10000 sec  |
| Audio                      | <ul style="list-style-type: none"> <li>• Full-duplex, half-duplex, simplex</li> <li>• External line or microphone input (LINE/MIC IN)</li> <li>• Mono audio (line level) output (LINE OUT) connects to PA system or active speaker with built-in amplifier</li> <li>• Audio compression: G.711 PCM 64kbit/s, G.726 ADPCM 32 or 24 kbit/s</li> </ul>   |
| Security                   | <ul style="list-style-type: none"> <li>• Multiple user access levels with password protection</li> <li>• IP address filtering</li> <li>• HTTPS encryption</li> <li>• Network authentication IEEE 802.1x</li> </ul>  |
| Alarm and event management | <ul style="list-style-type: none"> <li>• Events triggered by: built-in motion detection, external inputs, PTZ preset positions, audio detection or according to a schedule</li> <li>• Image upload over FTP, email and HTTP</li> <li>• Notification over TCP, email, HTTP and external outputs</li> <li>• Pre- and post alarm buffer of 9 MB per channel (approx. 4 min of CIF resolution video at 4 frames per second)</li> </ul>  |

| Item                                     | Specification  |
|--|--|
| Connectors                               | <ul style="list-style-type: none"> <li>• Ethernet 10BaseT/100BaseTX, RJ-45</li> <li>• Terminal block for 1 alarm input, 1 output and alternative power connection</li> <li>• Line/mic in 3,5mm tele jack</li> <li>• Line out 3,5mm tele jack</li> </ul>  |
| Casing                                   | Plastic  |
| Processors and memory                    | <ul style="list-style-type: none"> <li>• CPU: ETRAX 100LX 32bit</li> <li>• Video processing and compression: ARTPEC-2</li> <li>• RAM: 32 MB, Flash: 8 MB</li> <li>• Battery backed-up real-time clock</li> </ul>   |
| Power                                    | 11-13V DC, max 14 W  |
| Operating conditions                     | <ul style="list-style-type: none"> <li>• 0-45 °C (32-113 °F)</li> <li>• Humidity 20-80% RH (non-condensing)</li> </ul>   |
| Installation, management and maintenance | <ul style="list-style-type: none"> <li>• AXIS Camera Management tool on CD and web-based configuration</li> <li>• Configuration of backup and restore</li> <li>• Firmware upgrades over HTTP or FTP, firmware available at <a href="http://www.axis.com">www.axis.com</a></li> </ul>   |
| Video access from Web browser            | <ul style="list-style-type: none"> <li>• Camera live view,</li> <li>• Video recording to file (ASF)</li> <li>• Sequence tour for up to 20 PTZ presets or Axis video sources</li> <li>• Customizable HTML pages</li> </ul>  |
| Minimum web browsing requirements        | <ul style="list-style-type: none"> <li>• Pentium III CPU 500 MHz or higher, or equivalent AMD, 128 MB RAM, AGP graphics card 32 MB RAM, Direct Draw</li> <li>• Windows XP, 2000</li> <li>• DirectX 9.0 or later</li> <li>• Internet Explorer 6.x or later</li> </ul> <p>For other operating systems and browsers see <a href="http://www.axis.com/techsup">www.axis.com/techsup</a></p>  |
| System integration support               | <ul style="list-style-type: none"> <li>• Open API for software integration available at <a href="http://www.axis.com">www.axis.com</a>, including: AXIS VAPIX API, AXIS Media Control SDK, event trigger data in video stream</li> <li>• Quality of Service (QoS) Layer 3, DiffServ Model</li> <li>• Embedded Linux operating system</li> </ul>  |
| Supported protocols                      | <p>IPv4/v6, HTTP, HTTPS, SSL/TLS*, TCP, QoS, SNMPv1/v2c/v3 (MIB-II), RTSP, RTP, UDP, IGMP, RTCP, SMTP, FTP, ICMP, DHCP, UPnP, Bonjour, ARP, DNS, DynDNS, SOCKS, IEEE802.1X.</p> <p>More information on protocol usage available at <a href="http://www.axis.com">www.axis.com</a></p> <p>*This product includes software developed by the Open SSL Project for use in the Open SSL Tool kit (<a href="http://www.openssl.org">www.openssl.org</a>)</p> |
| Included accessories                     | <ul style="list-style-type: none"> <li>• Installation Guide</li> <li>• CD with User's Manual, demo software, installation and management tools</li> <li>• Ceiling mount kit</li> <li>• Power supply 12V DC 3A</li> <li>• MPEG-4 licenses (1 encoder, 1 decoder)</li> <li>• MPEG-4 decoder (Windows)</li> </ul>   |
| Video management software (not included) | <ul style="list-style-type: none"> <li>• AXIS Camera Station - Surveillance application for viewing, recording and archiving up to 25 cameras</li> <li>• See <a href="http://www.axis.com/partner/adp_partners.htm">www.axis.com/partner/adp_partners.htm</a> for more software applications via partners</li> </ul>   |
| Accessories (not included)               | <ul style="list-style-type: none"> <li>• Housings for adverse indoor/outdoor environments</li> <li>• AXIS 295 Video Surveillance Joystick</li> <li>• AXIS 292 Network Video Decoder</li> <li>• MPEG-4 decoder multi-user license pack</li> </ul>   |
| Approvals - EMC                          | <ul style="list-style-type: none"> <li>• EN55022 Class A,</li> <li>• EN 55024, EN61000-3-2</li> <li>• EN61000-3-3</li> <li>• EN61000-6-1</li> <li>• EN61000-6-2</li> <li>• FCC Part 15 Subpart B Class A</li> <li>• VCCI Class A</li> <li>• C-tick AS/NZS CISPR 22</li> <li>• ICES-003 Class A</li> <li>• EN60950UL, CSA (Power supply)</li> </ul>   |
| Maximum dimensions (HxWxD) and weight    | 179 x 152 x 157 mm (71/32 x 531/32 x 63/16) 1110 g (27/16 lbs)   |

The AXIS 214 PTZ (PAL) delivers the following file sizes:

| PAL           |            |              | PAL aspect ratio corrected |            |              |
|---------------|------------|--------------|----------------------------|------------|--------------|
|               | Resolution | Min-Max (KB) |                            | Resolution | Min-Max (KB) |
| 4CIF          | 704x576    | 10 - 300     | 4CIF                       | 768x576    | 11 - 330     |
| 2CIF expanded | 704x576    | 10 - 250     | 2CIF expanded              | 768x576    | 11 - 270     |
| 2CIF          | 704x288    | 5 - 150      | 2CIF                       | 768x288    | 5.5 - 160    |
| CIF           | 352x288    | 2.5 - 80     | CIF                        | 384x288    | 2.7 - 90     |
| QCIF          | 176x144    | 1 - 20       | QCIF                       | 192x144    | 1.1 - 22     |

The AXIS 214 PTZ (NTSC) delivers the following file sizes:

| NTSC          |            |              | NTSC aspect ratio corrected |            |              |
|---------------|------------|--------------|-----------------------------|------------|--------------|
|               | Resolution | Min-Max (KB) |                             | Resolution | Min-Max (KB) |
| 4CIF          | 704x480    | 8 - 250      | 4CIF                        | 640x480    | 7 - 230      |
| 2CIF expanded | 704x480    | 8 - 200      | 2CIF expanded               | 640x480    | 7 - 180      |
| 2CIF          | 704x240    | 4 - 125      | 2CIF                        | 640x240    | 3.5 - 110    |
| CIF           | 352x240    | 2 - 70       | CIF                         | 320x240    | 1.8 - 60     |
| QCIF          | 176x120    | 0.8 - 15     | QCIF                        | 160x120    | 0.7 - 14     |

### General performance considerations

When setting up the camera, it is important to consider how various settings and situations will affect performance. Some factors affect the amount of bandwidth (the bit rate) required, others can affect the frame rate, and some will affect both. If the load on the CPU reaches its maximum, this will also affect the frame rate.

The following factors are among the most important to consider:

- High image resolutions and/or lower compression levels result in larger images. Bandwidth affected.
- Access by large numbers of Motion JPEG and/or unicast MPEG-4 clients. Bandwidth affected.
- Simultaneous viewing of different streams (resolution, compression, etc.) by many clients. Frame rate and bandwidth affected.
- Accessing both Motion JPEG and MPEG-4 video streams simultaneously. Frame rate and bandwidth affected.
- Heavy usage of event settings affects the CPU load. Frame rate affected.
- Enabled motion detection. Frame rate and bandwidth affected.
- Heavy network utilization due to poor infrastructure. Bandwidth affected.
- Viewing on poorly performing client PC lowers perceived performance. Frame rate affected.
- Access by large number of audio clients using full-duplex mode. Bandwidth affected.

### Optimizing your system

To see the bandwidth and frame rate currently required by the video stream, the AXIS 214 PTZ provides a tool that can be used to display these values directly in the video image.

To do this, special format strings are added as part of a text overlay. Simply add **#r** (average frame rate in fps) and/or **#b** (average bandwidth in Kbps) to the overlay.

For detailed instructions, please see the online help for **Video & Image > Overlay Settings**, and the help for **File Naming & Date/Time Formats**.

**Overlay Settings**

Include overlay image at the coordinates:

Include date  Include time

Include text:

**Important!**

- The figures displayed here are the values as delivered by the camera. If other restrictions are currently in force, (e.g. bandwidth limitation) these values might not correspond to those actually received by the client.
- For Motion JPEG, these values will only be accurate as long as no frame rate limit has been specified.

**Frame rates - Motion JPEG**

The following test results show the frame rates in frames/second (fps) for Motion JPEG streams from the AXIS 214 PTZ, using a compression level of 50%. Note that these values are guidelines only - actual values may vary.

|               | fps   |
|---------------|-------|
| 4CIF          | 25/30 |
| 2CIF expanded | 25/30 |
| 2CIF          | 25/30 |
| CIF           | 25/30 |
| QCIF          | 25/30 |

**Frame rates - MPEG-4**

The following test results show the frame rates in frames/second (fps) for MPEG-4 streams from the AXIS 214 PTZ. Note that these values are guidelines only - actual values may vary.

The MPEG-4 test conditions:

- Compression level = 50%
- Video Object Type = Advanced Simple
- GOV structure = IP\*.

|               | fps   |
|---------------|-------|
| 4CIF          | 17/21 |
| 2CIF expanded | 17/21 |
| 2CIF          | 25/30 |
| CIF           | 25/30 |
| QCIF          | 25/30 |

\*Note that setting the GOV structure to use "I-frames only" will increase the frame rate.

**Bandwidth**

As there are many factors affecting bandwidth, it is very difficult to predict the required amounts. The settings that affect bandwidth are:

- the image resolution
- the image compression
- the frame rate
- the MPEG-4 object type
- the MPEG-4 GOV structure
- the audio settings.

There are also factors in the monitored scene that will affect the bandwidth. These are:

- the amount of motion
- the image's complexity
- the lighting conditions.

For MPEG-4, if there is only limited bandwidth available, and if this is more important than the image quality, using a constant bit rate (CBR) is recommended. Use a variable bit rate (VBR) if the image quality needs to be maintained at a higher level. If supported on the network, consider also using MPEG-4 multicasting, as the bandwidth consumption will be much lower.

## Glossary of Terms

**ActiveX** - A standard that enables software components to interact with one another in a networked environment, regardless of the language(s) used to create them. Web browsers may come into contact with ActiveX controls, ActiveX documents, and ActiveX scripts. ActiveX controls are often downloaded and installed automatically as required.

**AF (Autofocus)** - A system by which the camera lens automatically focuses on a selected part of the subject.

**Angle** - The field of view, relative to a standard lens in a 35mm still camera, expressed in degrees, e.g. 30°. For practical purposes, this is the area that a lens can cover, where the angle of view is determined by the focal length of the lens. A wide-angle lens has a short focal length and covers a wider angle of view than standard or telephoto lenses, which have longer focal lengths.

**ARP (Address Resolution Protocol)** - This protocol is used to associate an IP address to a hardware MAC address. A request is broadcast on the local network to discover the MAC address for an IP address.

**ARTPEC (Axis Real Time Picture Encoder)** - A chip designed by Axis for image compression. ARTPEC supports a range of CCD and CMOS sensors, built-in functionality for sharpening, backlight compensation, noise reduction and white balance, support for multiple Motion-JPEG streams, support for MPEG-4 part 2, up to 30 frames/second from 4 simultaneous video sources and real-time compression of up to 45 Megapixels/second.

**ASIC (Application Specific Integrated Circuit)** - A circuit designed for a specific application, as opposed to a general purpose circuit, such as a microprocessor.

**Aspect ratio** - A ratio of width to height in images. A common aspect ratio used for television screens and computer monitors is 4:3. High-definition television (HDTV) uses an aspect ratio of 16:9.

**Autoiris (or DC-Iris)** - This special type of iris is electrically controlled by the camera, to automatically regulate the amount of light allowed to enter.

**AVI (Audio Video Interleave)** - A video format that supports simultaneous playback of audio and video.

**Bitmap** - A bitmap is a data file representing a rectangular grid of pixels. It defines a display space and color for each pixel (or "bit") in the display space. This type of image is known as a "raster graphic." GIFs and JPEGs are examples of image file types that contain bitmaps.

Because a bitmap uses this fixed raster method, it cannot easily be rescaled without losing definition. Conversely, a vector graphic image uses geometrical shapes to represent the image, and can thus be quickly rescaled.

**Bit rate** - The bit rate (in kbit/s or Mbit/s) is often referred to as speed, but actually defines the number of bits/time unit and not distance/time unit.

**Bluetooth** - Bluetooth is an open standard for wireless transmission of voice and data between mobile devices (PCs, handheld computers, telephones and printers).

**Bonjour** - Also known as zero-configuration networking, Bonjour enables devices to automatically discover each other on a network, without having to enter IP addresses or configure DNS servers. Bonjour is a trademark of Apple Computer, Inc.

**Broadband** - In network engineering terms, this describes transmission methods where two or more signals share the same carrier. In more popular terminology, broadband is taken to mean high-speed data transmission.

**CCD (Charged Coupled Device)** - This light-sensitive image device used in many digital cameras is a large integrated circuit that contains hundreds of thousands of photo-sites (pixels) that convert light energy into electronic signals. Its size is measured diagonally and can be 1/4", 1/3", 1/2" or 2/3".

**CGI (Common Gateway Interface)** - A specification for communication between a web server and other (CGI) programs. For example, a HTML page that contains a form might use a CGI program to process the form data once it is submitted.

**CIF (Common Intermediate Format)** - CIF refers to the analog video resolutions 352x288 pixels (PAL) and 352x240 pixels (NTSC). See also *Resolution*.

**Client/Server** - Client/server describes the relationship between two computer programs in which one program, the client, makes a service request from another program, the server, which fulfils the request. Typically, multiple client programs share the services of a common server program. A web browser is a client program that requests services (the sending of web pages or files) from a web server.

**CMOS (Complementary Metal Oxide Semiconductor)** - A CMOS is a widely used type of semiconductor that uses both negative and positive circuits. Since only one of the circuit types is on at any given time, CMOS chips require less power than chips using just one type of transistor. CMOS image sensors also allow processing circuits to be included on the same chip, an advantage not possible with CCD sensors, which are also much more expensive to produce.

**Codec** - In communications engineering, a codec is usually a coder/decoder. Codecs are used in integrated circuits or chips that convert e.g. analog video and audio signals into a digital format for transmission. The codec also converts received digital signals back into analog format. A codec uses analog-to-digital conversion and digital-to-analog conversion in the same chip.

Codec can also mean compression/decompression, in which case it is generally taken to mean an algorithm or computer program for reducing the size of large files and programs.

**Compression** - See *Image Compression*.

**Contrast** - Defines the degree of difference between the lightest and darkest parts of an image or video stream.

**DC-Iris** - This special type of iris is electrically controlled by the camera, to automatically regulate the amount of light allowed to enter.

**DHCP (Dynamic Host Configuration Protocol)** - DHCP is a protocol that lets network administrators automate and centrally manage the assignment of Internet Protocol (IP) addresses to network devices in a network.

DHCP uses the concept of a "lease" or amount of time that a given IP address will be valid for a computer. The lease time can vary, depending on how long a user is likely to require the network connection at a particular location.

DHCP also supports static addresses for e.g. computers running web servers, which need a permanent IP address.

**DNS (Domain Name System)** - DNS is used to locate and translate Internet domain names into IP (Internet Protocol) addresses. A domain name is a meaningful and easy-to-remember name for an Internet address. For example the domain name www.example.com is much easier to remember than 192.0.34.166. The translation tables for domain names are contained in Domain name servers.

**Domain Server** - Domains can also be used by organizations who wish to centralize the management of their (Windows) computers. Each user within a domain has an account that usually allows them to log in to and use any computer in the domain, although restrictions may also apply. The domain server is the server that authenticates the users on the network.

**Duplex** - See *Full-duplex*.

**Ethernet** - Ethernet is the most widely installed local area network technology. An Ethernet LAN typically uses special grades of twisted pair wires. The most commonly installed Ethernet systems are 10BASE-T and 100BASE-T10, which provide transmission speeds up to 10 Mbps and 100 Mbps respectively.

**ETRAX (Ethernet Token Ring AXIS)** - Axis' own microprocessor.

**Factory default settings** - These are the settings that originally applied for a device when it was first delivered from the factory. If it should become necessary to reset a device to its factory default

settings, this will, for many devices, completely reset any settings that were changed by the user.

**Firewall** - A firewall works as a barrier between networks, e.g. between a Local Area Network and the Internet. The firewall ensures that only authorized users are allowed to access the one network from the other. A firewall can be software running on a computer, or it can be a standalone hardware device.

**Focal length** - Measured in millimeters, the focal length of a camera lens determines the width of the horizontal field of view, which in turn is measured in degrees.

**FTP (File Transfer Protocol)** - An application protocol that uses the TCP/IP protocols. It is used to exchange files between computers/devices on networks.

**Frame** - A frame is a complete video image. In the 2:1 interlaced scanning format of the RS-170 and CCIR formats, a frame is made up of two separate fields of 262.5 or 312.5 lines interlaced at 60 or 50 Hz to form a complete frame, which appears at 30 or 25 Hz. In video cameras with a progressive scan, each frame is scanned line-by-line and not interlaced; most are also displayed at 30 and 25 Hz.

**Frame rate** - The frame rate used to describe the frequency at which a video stream is updated is measured in frames per second (fps). A higher frame rate is advantageous when there is movement in the video stream, as it maintains image quality throughout.

**Full-duplex** - Transmission of data in two directions simultaneously. In an audio system this would describe e.g. a telephone systems. Half-duplex also provides bi-directional communication, but only in one direction at a time, as in a walkie-talkie system. See also *Simplex*.

**Gain** - The amplification factor and the extent to which an analog amplifier boosts the strength of a signal. Amplification factors are usually expressed in terms of power. Decibel (dB) is the most common way of quantifying the gain of an amplifier.

**Gateway** - A gateway is a point in a network that acts as an entry point to another network. In a corporate network for example, a computer server acting as a gateway often also acts as a proxy server and a firewall server. A gateway is often associated with both a router, which knows where to direct a given packet of data that arrives at the gateway, and a switch, which furnishes the actual path in and out of the gateway for a given packet.

**GIF (Graphics Interchange Format)** - GIF is one of the most common file formats used for images in web pages. There are two versions of the format, 87a and 89a. Version 89a supports animations, i.e. a short sequence of images within a single GIF file. GIF89a can also be specified for interlaced presentation.

**GOV (Group Of VOPs)** - A group of VOP's is the basic unit of an MPEG-4 video stream. The GOV contains different types and numbers of VOP's (I-VOP's, P-VOP's, etc.) as determined by the GOV length and GOV structure. See also *VOP*.

**GOV length** - The GOV length determines the number of images (VOP's) in the GOV structure. See also *GOV* and *VOP*.

**GOV structure** - The GOV structure describes the composition of an MPEG-4 video stream, as regards the type of images (I-VOP's or P-VOP's) included in the stream, and their internal order. See also *GOV* and *VOP*.

**Half-duplex** - See *Full-duplex*.

**HTML (Hypertext Markup Language)** - HTML is the set of "markup" symbols or codes inserted in a file intended for display in web browser. The markup tells the browser how to display the page's words and images for the user.

**HTTP (Hypertext Transfer Protocol)** - HTTP is the set of rules for exchanging files (text, graphic images, sound, video, and other multimedia files) on the web. The HTTP protocol runs on top of the TCP/IP suite of protocols.

**Hub** - A (network) hub is used to connect multiple devices to the network. The hub transmits all data to all devices connected to it, whereas a switch will only transmit the data to the device it is specifically intended for.

**IEEE 802.11** - A family of standards for wireless LANs. The 802.11

standard supports 1 or 2 Mbit/s transmission on the 2.4 GHz band. IEEE 802.11b specifies an 11 Mbit/s data rate on the 2.4 GHz band, while 802.11a allows up to 54 Mbit/s on the 5 GHz band.

**Image compression** - Image compression minimizes the file size (in bytes) of an image. Two of the most common compressed image formats are JPEG and GIF.

**Interlacing** - Interlaced video is video captured at 50 pictures (known as fields) per second, of which every 2 consecutive fields (at half height) are then combined into 1 frame. Interlacing was developed many years ago for the analog TV world and is still used widely today. It provides good results when viewing motion in standard TV pictures, although there is always some degree of distortion in the image.

To view interlaced video on e.g. a computer monitor, the video must first be de-interlaced, to produce progressive video, which consists of complete images, one after the other, at 25 frames per second. See also *Progressive scan*.

**IP (Internet Protocol)** - The Internet Protocol is a method transmitting data over a network. Data to be sent is divided into individual and completely independent "packets." Each computer (or host) on the Internet has at least one address that uniquely identifies it from all others, and each data packet contains both the sender's address and the receiver's address.

The Internet Protocol ensures that the data packets all arrive at the intended address. As IP is a connectionless protocol, which means that there is no established connection between the communication end-points, packets can be sent via different routes and do not need to arrive at the destination in the correct order.

Once the data packets have arrived at the correct destination, another protocol - Transmission Control Protocol (TCP) - puts them in the right order. See also *TCP*.

**IP Address** - An IP address is simply an address on an IP network used by a computer/device connected to that network. IP addresses allow all the connected computers/devices to find each other and to pass data back and forth.

To avoid conflicts, each IP address on any given network must be unique. An IP address can be assigned as fixed, so that it does not change, or it can be assigned dynamically (and automatically) by DHCP.

An IP address consists of four groups (or quads) of decimal digits separated by periods, e.g. 130.5.5.25. Different parts of the address represent different things. Some part will represent the network number or address, and some other part will represent the local machine address.

See also *IP (Internet Protocol)*.

**Infrared (IR)** - Infrared radiation is radiation at a longer wavelength than visible light, which means it cannot be seen by the naked human eye. As infrared radiation can be detected as heat, this can be shown on a screen or captured by a digital camera, with hotter objects showing up brighter against colder surroundings (e.g. a human body against a colder background).

As color cameras can "see" infrared radiation as well as visible light, these cameras are equipped with an IR-cut filter, to prevent distortion of the colors the human eye can see. To use the camera in very dark locations or at night, this filter can be removed, to allow infrared radiation to hit the image sensor and thus produce images.

An infrared lamp can be used for improved illumination for night surveillance, whilst not producing any extra visible light.

**Inputs/Outputs (I/O's)** - The digital I/Os on, for example, a network camera can be used to connect any device that can toggle between an open and a closed circuit.

If, for example, a door switch is used as an input device, opening the door could trigger the upload of video images and the sending of notification messages.

An output might, for example, be used to automatically start a siren when there is a motion detection trigger.

**I-VOP** - See *VOP*.

**JPEG (Joint Photographic Experts Group)** - Together with the GIF file format, JPEG is an image file type commonly used on the web. A JPEG image is a bitmap, and usually has the file suffix '.jpg' or '.jpeg.' When creating a JPEG image, it is possible to configure the level of compression to use. As the lowest compression (i.e. the highest quality) results in the largest file, there is a trade-off between image quality and file size.

**kbit/s (kilobits per second)** - A measure of the bit rate, i.e. the rate at which bits are passing a given point. See also *Bit rate*.

**LAN (Local Area Network)** - A LAN is a group of computers and associated devices that typically share common resources within a limited geographical area.

**Linux** - Linux is an open source operating system within the UNIX family. Because of its robustness and availability, Linux has won popularity in the open source community and among commercial application developers.

**MAC address (Media Access Control address)** - A MAC address is a unique identifier associated with a piece of networking equipment, or more specifically, its interface with the network. For example, the network card in a computer has its own MAC address.

**Manual iris** - This is the opposite to an autoiris, i.e. the camera iris must be adjusted manually to regulate the amount of light allowed to reach the image sensor.

**Mbit/s (Megabits per second)** - A measure of the bit rate, i.e. the rate at which bits are passing a given point. Commonly used to give the "speed" of a network. A LAN might run at 10 or 100 Mbit/s. See also *Bit rate*.

**Monitor** - A monitor is very similar to a standard television set, but lacks the electronics to pick up regular television signals.

**Motion JPEG** - Motion JPEG is a simple compression/decompression technique for networked video. Latency is low and image quality is guaranteed, regardless of movement or complexity of the image. Image quality is controlled by adjusting the compression level, which in turn provides control over the file size, and thereby the bit rate.

High-quality individual images from the Motion JPEG stream are easily extracted. See also *JPEG*.

**Megapixel** - See *Pixel*.

**MPEG (Moving Picture Experts Group)** - The Moving Picture Experts Group develops standards for digital video and audio compression. It operates under the auspices of the International Organization for Standardization (ISO). The MPEG standards are an evolving series, each designed for a different purpose.

**MPEG-2** - MPEG-2 is the designation for a group of audio and video coding standards, and is typically used to encode audio and video for broadcast signals, including digital satellite and Cable TV. MPEG-2, with some modifications, is also the coding format used by standard commercial DVD movies.

**MPEG-4** - MPEG-4 is a group of audio and video coding standards and related technology. The primary uses for the MPEG-4 standard are web (streaming media) and CD distribution, conversational (videophone), and broadcast television.

Most of the features included in MPEG-4 are left to individual developers to decide whether to implement them or not. This means that there are probably no complete implementations of the entire MPEG-4 set of standards. To deal with this, the standard includes the concept of "profiles" and "levels", allowing a specific set of capabilities to be defined in a manner appropriate for a subset of applications.

**Multicast** - Bandwidth-conserving technology that reduces bandwidth usage by simultaneously delivering a single stream of information to multiple network recipients.

**Multiplexer** - A multiplexer is a high-speed switch that provides full-screen images from up to 16 analog cameras. Multiplexers can playback everything that happened on any one camera with no interference from the other cameras on the system.

**Network connectivity** - The physical (wired or wireless) and logical (protocol) connection of a computer network or an individual device

to a network, such as the Internet or a LAN.

**NTSC (National Television System Committee)** - NTSC is the television and video standard in the United States. NTSC delivers 525 lines at 60 half-frames/second.

**OEM (Original Equipment Manufacturer)** - This is a designation for companies that manufacture equipment which is then marketed and sold to other companies under their own names.

**PAL (Phase Alternating Line)** - PAL is the dominant television standard in Europe. PAL delivers 625 lines at 50 half-frames/second.

**PEM (Privacy Enhanced Mail)** - An early standard for securing electronic mail. The PEM-format is often used for representing an HTTPS certificate or certificate request.

**Ping** - Ping is a basic network program used diagnostically to check the status of a network host or device. Ping can be used to see if a particular network address (IP address or host name) is occupied or not, or if the host at that address is responding normally. Ping can be run from e.g. the Windows Command prompt or the command line in UNIX.

**Pixel (Picture element)** - A pixel is one of the many tiny dots that make up a digital image. The color and intensity of each pixel represents a tiny area of the complete image.

**PoE (Power over Ethernet)** - Power over Ethernet provides power to a network device via the same cable as used for the network connection. This is very useful for IP-Surveillance and remote monitoring applications in places where it may be too impractical or expensive to power the device from a power outlet.

**PPP (Point-to-Point Protocol)** - A protocol that uses a serial interface for communication between two network devices. For example, a PC connected by a phone line to a server.

**PPTP (Point-to-Point Tunneling Protocol)** - A protocol (set of communication rules) that allows corporations to extend their own corporate network through private "tunnels" over the public Internet. In this way a corporation can effectively use a WAN (Wide Area Network) as a large single LAN (Local Area Network). This kind of interconnection is known as a virtual private network (VPN). See also *VPN*.

**Pre/post alarm images** - The images from immediately before and after an alarm. These images are stored in a buffer for later retrieval.

**Progressive scan** - Progressive scan, as opposed to interlaced video, scans the entire picture, line by line every sixteenth of a second. In other words, captured images are not split into separate fields as in interlaced scanning.

Computer monitors do not need interlace to show the picture on the screen, but instead show them progressively, on one line at a time in perfect order, i.e. 1, 2, 3, 4, 5, 6, 7 etc., so there is virtually no "flickering" effect. In a surveillance application, this can be critical when viewing detail within a moving image, such as a person running. A high-quality monitor is required to get the best from progressive scan. See also *Interlacing*.

**Protocol** - A special set of rules governing how two entities will communicate. Protocols are found at many levels of communication, and there are hardware protocols and software protocols.

**Proxy server** - In an organization that uses the Internet, a proxy server acts as an intermediary between a workstation user and the Internet. This provides security, administrative control, and a caching service. Any proxy server associated with a gateway server, or part of a gateway server, effectively separates the organization's network from the outside network and the local firewall. It is the firewall server that protects the network against outside intrusion.

A proxy server receives requests for Internet services (such as web page requests) from many users. If the proxy server is also a cache server, it looks in its local cache of previously downloaded web pages. If it finds the page, it is returned to the user without forwarding the request to the Internet. If the page is not in the cache, the proxy server, acting as a client on behalf of the user, uses one of its own IP addresses to request the page from another server over the Internet. When the requested page is returned, the proxy server forwards it to



the user that originally requested it.

**P-VOP** - See *VOP*.

**Resolution** - Image resolution is a measure of how much detail a digital image can hold: the greater the resolution, the greater the level of detail. Resolution can be specified as the number of pixel-columns (width) by the number of pixel-rows (height), e.g. 320x240.

Alternatively, the total number of pixels (usually in megapixels) in the image can be used. In analog systems it is also common to use other format designations, such as CIF, QCIF, 4CIF, etc.

**RTCP (Real-Time Control Protocol)** - RTCP provides support for real-time conferencing of groups of any size within an intranet. This support includes source identification and support for gateways like audio and video bridges as well as multicast-to-unicast translators.

RTCP offers quality-of-service feedback from receivers to the multicast group as well as support for the synchronization of different media streams.

**RTP (Real-Time Transport Protocol)** - RTP is an Internet protocol for the transport of real-time data, e.g. audio and video. It can be used for media-on-demand as well as interactive services such as Internet telephony.

**RTSP (Real Time Streaming Protocol)** - RTSP is a control protocol, and a starting point for negotiating transports such as RTP, multicast and Unicast, and for negotiating codecs.

RTSP can be considered a "remote control" for controlling the media stream delivered by a media server. RTSP servers typically use RTP as the protocol for the actual transport of audio/video data.

**Router** - A device that determines the next network point to which a packet should be forwarded on its way to its final destination. A router creates and/or maintains a special routing table that stores information on how best to reach certain destinations. A router is sometimes included as part of a network switch. See also *switch*.

**Server** - In general, a server is a computer program that provides services to other computer programs in the same or other computers. A computer running a server program is also frequently referred to as a server. In practice, the server may contain any number of server and client programs. A web server is the computer program that supplies the requested HTML pages or files to the client (browser).

**Sharpness** - This is the control of fine detail within a picture. This feature was originally introduced into color TV sets that used notch filter decoders. This filter took away all high frequency detail in the black and white region of the picture. The sharpness control attempted to put some of that detail back in the picture. Sharpness controls are mostly superfluous in today's high-end TVs. The only logical requirement for it nowadays is on a VHS machine.

**Simplex** - In simplex operation, a network cable or communications channel can only send information in one direction.

**SMTP (Simple Mail Transfer Protocol)** - SMTP is used for sending and receiving e-mail. However, as it is "simple," it is limited in its ability to queue messages at the receiving end, and is usually used with one of two other protocols, POP3 or IMAP. These other protocols allow the user to save messages in a server mailbox and download them periodically from the server.

SMTP authentication is an extension of SMTP, whereby the client is required to log into the mail server before or during the sending of email. It can be used to allow legitimate users to send email while denying the service to unauthorized users, such as spammers.

**SNMP (Simple Network Management Protocol)** - SNMP forms part of the Internet Protocol suite, as defined by the IETF (Internet Engineering Task Force). The protocol can support monitoring of network-attached devices for any conditions that warrant administrative attention.

**Sockets** - Sockets are a method for communication between a client program and a server program over a network. A socket is defined as "the endpoint in a connection." Sockets are created and used with a set of programming requests or "function calls" sometimes called the sockets application programming interface (API).

**SSL/TSL (Secure Socket Layer/Transport Layer Security)** - These

two protocols (SSL is succeeded by TSL) are cryptographic protocols that provide secure communication on a network. SSL is commonly used over HTTP to form HTTPS, as used e.g. on the Internet for electronic financial transactions. SSL uses public key certificates to verify the identity of the server.

**Subnet & subnet mask** - A subnet is an identifiably separate part of an organization's network. Typically, a subnet may represent all the machines at one geographic location, in one building, or on the same local area network (LAN). Having an organization's network divided into subnets allows it to be connected to the Internet with a single shared network address.

The subnet mask is the part of the IP address that tells a network router how to find the subnet that the data packet should be delivered to. Using a subnet mask saves the router having to handle the entire 32-bit IP address; it simply looks at the bits selected by the mask.

**Switch** - A switch is a network device that connects network segments together, and which selects a path for sending a unit of data to its next destination. In general, a switch is a simpler and faster mechanism than a router, which requires knowledge about the network and how to determine the route. Some switches include the router function. See also *Router*.

**TCP (Transmission Control Protocol)** - TCP is used along with the Internet Protocol (IP) to transmit data as packets between computers over the network. While IP takes care of the actual packet delivery, TCP keeps track of the individual packets that the communication (e.g. requested a web page file) is divided into and, when all packets have arrived at their destination, it reassembles them to re-form the complete file.

TCP is a connection-oriented protocol, which means that a connection is established between the two end-points and is maintained until the data has been successfully exchanged between the communicating applications.

**Telnet** - Telnet is a simple method with which to access another network device, e.g. a computer. The HTTP protocol and the FTP protocols allow you to request specific files from remote computers, but do not allow you logon as a user of that computer. With Telnet, you log on as a regular user with whatever privileges you may have been granted for specific applications and data residing on that computer.

**TVL (TV Lines)** - A method of defining resolutions in analog video.

**UDP (User Datagram Protocol)** - UDP is a communications protocol that offers limited service for exchanging data in a network that uses the Internet Protocol (IP). UDP is an alternative to the Transmission Control Protocol (TCP). The advantage of UDP is that it is not required to deliver all data and may drop network packets when there is e.g. network congestion. This is suitable for live video, as there is no point in re-transmitting old information that will not be displayed anyway.

**Unicast** - Communication between a single sender and a single receiver over a network. A new connection is established for each new user.

**UPnP™** - A set of computer network protocols that allows the automatic peer-to-peer detection of devices on the network. UPnP is promoted by the UPnP Forum.

**URL (Uniform Resource Locator)** - An "address" on the network.

**USB** - (Universal Serial Bus) A plug-and-play interface between a computer and peripheral devices, e.g. scanners, printers, etc.

**Varifocal lens** - A varifocal lens provides a wide range of focal lengths, as opposed to a lens with a fixed focal length, which only provides one.

**VPN (Virtual Private Network)** - This creates a secure "tunnel" between the points within the VPN. Only devices with the correct "key" will be able to work within the VPN. The VPN network can be within a company LAN (Local Area Network), but different sites can also be connected over the Internet in a secure way. One common use for VPN is for connecting a remote computer to the corporate network, via e.g. a direct phone line or via the Internet.

**VOP (Video Object Plane)** - A VOP is an image frame in an MPEG-4 video stream. There are several types of VOP:

- An I-VOP is complete image frame.
- A P-VOP codes the differences between images, as long as it is more efficient to do so. Otherwise it codes the whole image, which may also be a completely new image.

**WAN (Wide-Area-Network)** - Similar to a LAN, but on a larger geographical scale.

**WLAN (Wireless LAN)** - A wireless LAN is a wireless local area network that uses radio waves as its carrier: where the network connections for end-users are wireless. The main network structure usually uses cables.

**Web server** - A web server is a program that allows web browsers to retrieve files from computers connected to the Internet. The web server listens for requests from web browsers and, upon receiving a request for a file, sends it back to the browser.

The primary function of a web server is to serve pages to other remote computers; consequently, it needs to be installed on a computer that is permanently connected to the Internet. It also controls access to the server, whilst monitoring and logging server access statistics.

**WEP (Wireless Equivalent Privacy)** - A wireless security protocol, specified in the IEEE 802.11 standard, which is designed to provide a WLAN (Wireless Local Area Network) with a level of security and privacy comparable to that usually expected of a wired LAN. Security is at two different levels; 40-bit and 128-bit encryption. The higher the bit number, the more secure the encryption.

**WINS (Windows Internet Naming Service)** - Part of the Microsoft Windows NT Server, WINS manages the association of workstation names and locations with IP addresses, without the user or administrator having to be involved in each configuration change.

**WPA-PSK (Wi-Fi Protected Access - Pre-Shared Key)** - This wireless encryption method uses a pre-shared key (PSK) for key management. Keys can usually be entered as manual hex values, as hexadecimal characters, or as a Passphrase. WPA-PSK provides a greater degree of security than WEP.

**Zoom lens** - A zoom lens can be moved (zoomed) to enlarge the view of an object to show more detail.

# Index

---

## A

- Accessing the video stream 13
- Action 25
- Action Buttons 22
- Active/Inactive 22
- Administrator 29
- Administrators 14
- Advanced Simple profile 11
- Alarm 25, 27, 38
- AMC 9, 12
- ARP/Ping 32
- Audio 18
- Audio input 19
- Audio mode 18
- Audio output 19
- Auxiliary Power 38
- AXIS Media Control 18

## B

- Backup 36
- Bandwidth 11, 45
- Bit rate 11
- Buffer Size 26
- Buffers 26

## C

- CGI links 22
- Connection Module 38
- Constant bit rate 11
- Control Button 6
- Control Panel 9

## D

- Date & Time 32
- Default 36
- Default Video Format 22
- Default Viewer 22
- DNS Configuration 33
- DNS Server 33
- Domain Name 33

## E

- Enable ARP/Ping 32
- Event 25
- Event Servers 25
- Event Types 26

## F

- Factory Default 37
- File Sizes (NTSC) 44
- File Sizes (PAL) 44
- Frame Rate 16
- Frame rates 45

- FTP Server 25
- Full duplex 18

## H

- Half duplex 18
- Host Name 33
- HTML Examples 23
- HTTP API 22
- HTTP Server 25

## I

- Input 38
- IP Address Filtering 29
- IR light 9

## L

- LED Settings 36
- Live View 14
- Live View Config 21
- Logs & Reports 36

## M

- Motion Detection 27
- Motion JPEG 11
- MPEG-4 5, 11, 17
- MPEG-4 protocols 12
- Multicasting 12

## N

- NAT traversal 34
- Network 32
- Network Connector 6
- NTP Configuration 33
- NTP Server 32

## O

- Operator 29
- Other MPEG-4 clients 13
- Output 38
- Output Buttons 22
- Overlay Image 16
- Overlay Settings 16
- Own Home Page 22
- Own web files 21

## P

- Pan/Tilt/Zoom Control Queue 10
- Pan/Tilt/Zoom Controls 10
- Pinout 36
- Pinout - I/O connectors 38
- Port Status 28
- Ports & Devices 36
- Post-trigger Buffer 26
- Power Connector 6
- Pre-trigger Buffer 26
- PTZ Commands 22

Pulse 8, 22  
Push to talk 18

## R

Referrals 29  
Restart 36  
Restore 36  
RTP 12  
RTSP 12

## S

Scheduled Event 25, 27  
Security 29  
Security/Users 29  
Sequence Mode 8  
Server Time 32  
Services 32  
Setup 14  
Simple profile 11  
SMTP 35  
Snapshot 8  
SOCKS 35  
Streaming MPEG-4 12  
Support 36  
System Options 29

## T

TCP Server 25  
Time Mode 32  
Triggered Event 25, 26  
Troubleshooting 39

## U

UDP 12  
Unicasting 12  
Upgrade Server 36  
UPnP 35  
User 29  
User Defined Links 22  
User List 29

## V

Variable bit rate 11  
Video Stream 16