

Miele

Operating and Installation Instructions

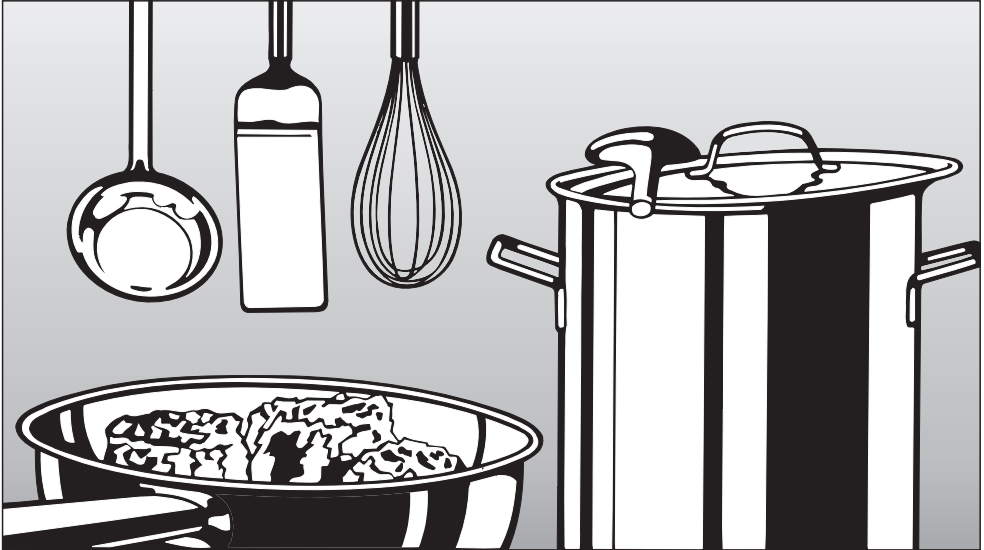

Ceramic Cooktop with Induction KM 5753 KM 5758

To prevent accidents and
machine damage,
read the Operating Manual
before
installation or use.

en - US, CA

M.-Nr. 06 766 201

Contents

IMPORTANT SAFETY INSTRUCTIONS	4
Guide to the cooktop	10
Cooktop	10
Burner controls and displays	11
Timer control and display	12
Burner data	12
Induction	13
How it works	13
Noises	14
Cookware	15
Before using for the first time	16
Heat the cooktop	16
Use	17
Touch controls	17
Turning on the cooktop	17
Turning on a burner	17
Settings	18
Auto-heat	19
Booster function	21
Turning off a burner	23
Turning off the cooktop	23
Residual heat indicator	23
Timer	24
Setting the timer	24
Automatic switch-off	25
Combi mode	26
Safety features	27
Child Safety Lock	27
Stop and Go	28
Safety cut-out feature	29
Overheating protection	30

Cleaning and Care	31
Programming	32
Frequently asked questions	35
Technical Service	37
IMPORTANT SAFETY INSTRUCTIONS	40
Installation	42
Installation dimensions	43
Ventilation	44
Installing the cooktop	45
Electrical connection	47
Help protect our environment	48

IMPORTANT SAFETY INSTRUCTIONS

READ THE OPERATING INSTRUCTIONS CAREFULLY BEFORE USING THE COOKTOP

WARNING -

This appliance is intended for residential cooking only. The manufacturer cannot be held responsible for damage or injury caused by improper use or for uses other than those for which this appliance is intended.

When using your appliance follow basic safety precautions including the following:

Installation

- ▶ Be certain your appliance is properly installed and grounded by a qualified technician in accordance with national and local safety regulations. The manufacturer cannot be held responsible for damage caused by incorrect installation or connection.
- ▶ Do not connect the appliance to the main electrical supply using an extension cord. Extension cords do not meet the safety requirements of this appliance.
- ▶ Before servicing, disconnect the appliance from the main power supply.
- ▶ To guarantee the electrical safety of this appliance, continuity must exist between the appliance and an effective grounding system. It is imperative that this basic safety requirement be met. If there is any doubt, have the electrical system of the house checked by a qualified electrician. The manufacturer will not be held responsible for damages caused by the lack, or inadequacy, of an effective grounding system.
- ▶ Only for frame/facet cooktops: A small gap will be visible between cooktop and countertop for the first days after installation. The gap will decrease as the cooktop is used. The electrical safety of your appliance is warranted despite the small gap.

IMPORTANT SAFETY INSTRUCTIONS

Use

▶ Only use the cooktop for residential cooking, and for the purposes described in this manual.

Other uses are not permitted and can be dangerous. The manufacturer will not be held liable for damage caused by unauthorized use or improper operation of any kind.

▶ Persons who lack physical, sensory or mental abilities, or experience with the appliance should not use it without supervision or instruction by a responsible person.

▶ Individuals with a pacemaker or similar medical device: Please note that an electromagnetic field develops when the cooktop is turned on. Although unlikely that this will affect a pacemaker or other medical device, please consult the device manufacturer or your doctor if you have concerns.

▶ Keep magnetized items, e.g. credit cards, disks, etc. away from the cooktop while in operation. Damage may result.

▶ Do not use the appliance until it has been properly installed in the countertop.

▶ This appliance is equipped with an overheating protection feature. See "Overheating protection" for more information.

▶ Be sure to use the proper type of cookware. Follow the manufacturer's instructions.

▶ If the cooktop is installed above a pyrolytic oven it should not be used during the pyrolytic process. The overheating protection feature of the cooktop might be activated.

IMPORTANT SAFETY INSTRUCTIONS

Injury prevention

▶ Children should not be left unattended in an area where the cooktop is in use. Never allow children to sit or stand on any part of the cooktop.

Caution: Do not store items of interest to children in cabinets above the cooktop. Children climbing on the cooktop to reach these items could be injured.

▶ Use the Child Safety Lock to prevent children from turning on the burners or changing the settings. See "Child Safety lock" for more information.

▶ Keep all pots and pans out of children's reach. Danger of burning or scalding.

▶ Do not touch the cooktop or the surrounding areas during or immediately after use. The cooktop may be hot even though it is dark in color. Wait until the residual heat indicators go out.

▶ Protect your hands with insulated gloves or potholders when using the appliance. Use only dry, heat resistant potholders. Moist or damp potholders used on hot surfaces can result in steam burns. Do not let the potholder touch the hot heating elements. Do not use towels or other bulky items near the appliance.

▶ Be aware of loose fitting or hanging clothing when operating the cooktop, they may present a fire hazard.

▶ Pot and pan handles should be turned inward and not extend over the countertop to reduce the risk of burns, ignition of flammable materials, and spills.

▶ Never leave a cooktop unattended at high settings or when cooking with oil or fat. Overheated oil could ignite. Always heat oil slowly, monitoring it as it heats.

▶ Do not use water on grease fires. Smother or use a dry chemical or foam-type extinguisher on any fire or flame.

▶ When frying food make sure that the food is as dry as possible before placing it in oil. Moisture can cause hot oil to splatter and boil over. At high settings, be cautious of splattering grease or boiling over liquids which may produce smoke.

▶ Do not flambé under an exhaust hood. Flames could be drawn up into the hood by the suction and the grease filters may ignite.

▶ Do not heat unopened containers. Built-up pressure may cause the container to burst and result in injury.

IMPORTANT SAFETY INSTRUCTIONS

- ▶ Before removing pots and pans be sure to turn off the burners.
- ▶ To prevent burns and breathing difficulty, allow the cooktop to cool before cleaning. Some cleaners may produce toxic fumes if applied to a hot surface.
- ▶ When wiping spills on a hot cooktop with a wet sponge or cloth, be careful to avoid steam burns.
- ▶ Do not let flammable materials, i.e. cooking grease, accumulate on the appliance.
- ▶ Never cover the cooktop with a cloth. A fire may result.
- ▶ Do not place items other than pots and pans on the cooktop.
- ▶ Flammable materials should not be stored on or near the appliance.
- ▶ The cooktop is fitted with a cooling fan. Drawers under the cooktop are not recommended. If a drawer is fitted directly underneath the cooktop, ensure that there is sufficient space between the drawer, its contents and the underside of the appliance in order to ensure sufficient ventilation for the cooktop. Do not store small items or paper in the drawer. They could get sucked into the housing by the fan and cause damage or impair cooling. Ensure that no aerosols, combustible liquids or other flammable materials are kept in this drawer. If cutlery inserts are to be placed in the drawer they must be made of heat-resistant material.

IMPORTANT SAFETY INSTRUCTIONS

Damage protection

- ▶ Never place hot pots or pans on the touch controls, this may damage the electronics.
- ▶ Do not drop anything on the ceramic surface of the cooktop. Even lightweight objects may cause damage.
- ▶ Do not use pots or pans with pronounced edges or ridges on the ceramic cooktop. These could scratch the cooktop permanently. See "Cookware" for more information. Grains of salt and sand can cause scratches. Make sure that the bases of any pots and pans are clean, free of any fat or oils, and are dry.
- ▶ Do not allow solid or liquid sugar, pieces of plastic or foil to fall on the burners when they are hot. If these residues are allowed to cool on the ceramic surface pitting or even cracking may occur.
- ▶ Any spills should be removed as quickly as possible to prevent them from burning on and becoming difficult to remove.
- ▶ Do not use a steam cleaner to clean this appliance. Steam could penetrate electrical components and cause a short circuit.

IMPORTANT SAFETY INSTRUCTIONS

Appliance safety

► In the event of any damage to the appliance, it must be turned off immediately and disconnected from the main power supply. Contact Miele's Technical Service Department.

Do not use the appliance until it has been repaired. Ensure power is not supplied to the appliance until repair work is completed.

► Do not cook on a damaged cooktop. Any breakages or cracks in the ceramic surface of the appliance are defects and must be treated as such. If the cooktop should break, cleaning solutions and spills may penetrate the broken cooktop and create a risk of electric shock. Do not use the appliance until it has been repaired.

► Repairs should only be performed by qualified technicians to ensure safety. Repairs and other work by unqualified persons could be dangerous. Do not open the outer casing of the appliance under any circumstances.

► While the appliance is under warranty repairs should only be performed by an authorized service technician. Otherwise the warranty is void.

Further safety notes

► Make certain that the power cords of small appliances do not come in contact with the cooktop. The insulation of the cable could become damaged. Danger of electric shock!

► Keep pets away from the cooktop at all times and activate the Safety Lock. If a pet gets on the cooktop a touch control sensor could be activated turning on a burner.

SAVE THESE INSTRUCTIONS AND REVIEW THEM PERIODICALLY

Guide to the cooktop

Cooktop

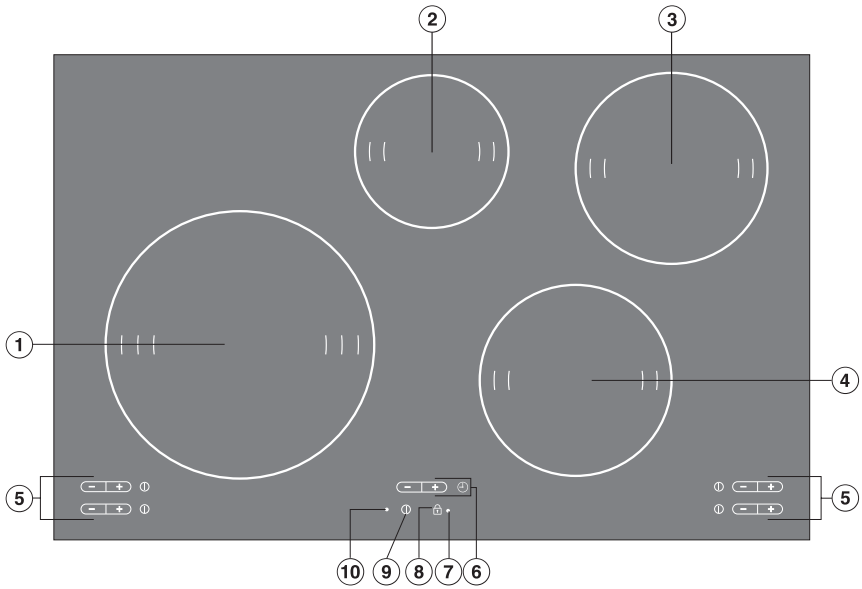

- ① Burner with double booster
- ②③④ Burners with single booster
- ⑤ Burner controls and displays
- ⑥ Timer controls and display
- ⑦ Child safety lock indicator
- ⑧ Child safety lock control
- ⑨ Cooktop On/Off control
- ⑩ Cooktop "On" indicator

Burner controls and displays



- ① Power level touch controls
- ② Burner On/Off touch controls
- ③ Booster indicator
- ④ Indicator for "Auto heat" or extended power level (see "Programming"), e.g. front left burner

⑤ Displays:

- = Burner is ready for use
- 0 = Burner is turned on
- 1 to 9 = Power level
- ≡ = Residual heat
- ∪ = No pan on burner or pan unsuitable (see "Induction - How it works")
- I = Single booster function activated
- II = Double booster function activated (only front left burner)
- F = Fault (see "Safety cut-out feature")
- R = Auto-heat with extended power level
- PD etc. = Program (see "Programming")
- SD etc. = Status (see "Programming")

Guide to the cooktop

Timer control and display

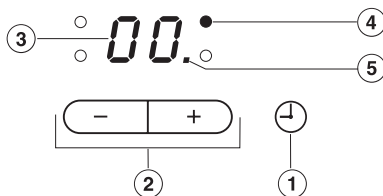

- ① Touch control to:
 - turn the timer on/off,
 - switch between functions, and
 - select a burner for "automatic switch-off".
- ② Touch control for setting the time
- ③ Time display
- ④ Automatic switch-off indicator
- ⑤ Timer indicator

Burner data

Burner	min to max diameter *	Rating in watts		
			208 V**	240 V**
	7" - 11" (18 cm - 28 cm)	normal: with booster 1: with booster 2:	2200 2700 3350	2500 3100 3850
	4" - 7" (10 cm - 16 cm)	normal: with booster:	1250 1650	1450 1900
	5 1/2" - 8" (14 cm - 20 cm)	normal: with booster:	1700 2250	1950 2600
	5 1/2" - 8" (14 cm - 20 cm)	normal: with booster:	1700 2250	1950 2600
		Total:	6700	7700

* Pans with a base diameter within the given range may be used.

** The wattage quoted may vary depending on the size and material of the pans used.

How it works

An induction coil is located under each burner. When a burner is switched on, this coil creates a magnetic field which impacts directly on the base of the pan and heats it up. The burner itself is heated indirectly by the heat given off by the pan.

Induction burners only work when a magnetic based pan is placed on it (see "Cookware").

Induction automatically recognizes the size of the pan, i.e. heat is only generated in the area covered by the base of the pan.

The burner will not work:

- if it is switched on without a pan in place, or if the pan is unsuitable (non-magnetic base).
- if the diameter of the pan is too small.
- if the pan is taken off the burner when it is switched on.

If this happens, **U** will flash in the relevant burner display alternating with **D** or the last selected power level selected.

If a suitable pan is placed on the burner within 3 minutes, the **U** will go out and you can continue cooking as normal.

If no pan or an unsuitable pan is placed on the burner, the burner and the cooktop will switch off automatically after 3 minutes.

Be careful not to place cutlery or other metal objects on the cooktop. When the appliance is switched on, or when there is residual heat present, there is the risk of metal objects heating up quickly. Beware of burns. Depending on the material, other objects left on the cooktop could also melt or catch fire. Switch the burners off after use.

Induction

Noises

When using an induction burner, the following noises can occur in the pan, depending on what it is made of and how it is constructed.

- Higher power settings may cause a buzz. This will decrease or cease altogether when the power setting is reduced.
- If the pan base is made of layers of different materials (e.g. a sandwiched base), a cracking sound may be heard.
- Whistling might occur if linked burners (see "Booster function") are being used on the highest setting at the same time, and the pans have bases made of layers of different materials.
- You may hear a clicking sound from the electronic switches, especially on lower settings.

The appliance has a cooling fan to help extend the life of the electronics. When the cooktop is being used at high levels for a long period of time, this will come on and you will hear a whirring sound. The fan may continue to run after the appliance has been switched off.

Cookware

Suitable pans include:

- stainless steel pans with a magnetic base
- enameled steel pans
- cast iron pans

Unsuitable pans:

- stainless steel pans without a magnetic base
- aluminum and copper pans
- glass, ceramic or earthenware pots and pans

To test whether a pot or pan is suitable for use on an induction cooktop, hold a magnet to the base of the pan. If the magnet sticks, the pan is suitable.

Unless the pan manufacturer states that you can do so, do not use pans with very thin bases on this cooktop, and never heat up empty pans. This could damage the appliance and cookware.

Pan size

To make optimum use of the burners, choose cookware that fits between the inner and outer marking of the burner. If the base diameter of the pan is smaller than the inner marking, the induction heating will not work. The burner will behave as if it had no pan on it.

Before using for the first time

Clean the cooktop

- Before using for the first time, clean the appliance with a damp cloth and dry with a soft cloth.

Heat the cooktop

Metal components of the cooktop have a protective coating which may give off a slight odor the first time the appliance is heated.

The smell will dissipate after a short time and does not indicate a faulty connection or appliance defect.

Touch controls

The control panel on your ceramic cooktop is equipped with electronic sensors. They respond to a finger touch.

To operate the burners, simply touch the corresponding sensor area(s). Each time a command is registered, a signal will be heard.

Be sure to touch only the desired sensor area and keep the control panel clean and clear. Otherwise, the touch controls may not respond, or unintentional commands may be given, even causing the cooktop to switch off automatically (see the section on "Safety cut-out feature"). NEVER place hot cookware on the sensor areas. The electronics can be damaged.

Turning on the cooktop

- Put a pot or pan on the desired burner.
- Touch the ON/OFF "Ⓢ" cooktop touch control.

You will see a dash - in each of the burner displays, and the On/Off indicator will light. If a setting is not chosen within a few seconds the cooktop will turn itself off as a safety measure.

Turning on a burner

- Touch the Ⓢ On/Off touch control for the desired burner.

The respective burner display shows 0.

- Select a power level between 1 and 9 by pressing the + or - control.

When turning on the cooktop you can decide whether you want to cook with auto heat or not. See "Auto-heat" for more information.

Turn on with + to:

cook **without** auto-heat.

Turn on with – to:

cook **with** auto-heat.

Use

Settings

Use for	Power level*	
	standard factory settings (9 power levels)	extended settings** (17 power levels)
Melting butter Dissolving gelatine	1 - 2	1 - 2.
Thickening sauces containing egg yolk and/or butter Warming small quantities of food/liquid Cooking rice Thaw frozen vegetables (blocks)	3	3 - 3.
Warming liquid and half-set foods Thickening sauces, e.g. Hollandaise Making oatmeal Preparing omelettes, lightly fried eggs Steaming fruit	4	4 - 4.
Defrosting deep frozen food Steaming vegetables, fish Cooking broths, soups	5	5
Bringing large quantities of food to a boil Cooking dumplings	6	5. - 6
Gentle frying (without overheating the fat) meat, fish, vegetables, fried eggs	7	6. - 7.
Frying pancakes, etc.	8	8 - 8.
Boiling large quantities of water	9	9

* These settings are intended as guidelines only. With deep pans, larger quantities of food or when cooking without a lid, a higher setting is required. For smaller quantities, select a lower setting.

** If you wish to fine-tune a setting, you can extend the power level range (see "Programming - P2"). The intermediate setting will be represented by an indicator next to the number.

Auto-heat

When Auto-heat has been activated, the burner switches on automatically at the highest setting and then switches to the continued power level which was selected. The "heat-up" time depends on which continued power level has been chosen (see table).

Taking a pan off the zone while Auto-heat is in operation interrupts the function. It will resume if a pan is placed back on the zone within 3 minutes.

Continued power level*	Heat-up time (approx.) min : sec
1	0 : 15
1.	0 : 15
2	0 : 15
2.	0 : 15
3	0 : 25
3.	0 : 25
4	0 : 50
4.	0 : 50
5	2 : 00
5.	5 : 50
6	5 : 50
6.	2 : 50
7	2 : 50
7.	2 : 50
8	2 : 50
8.	2 : 50
9	-

* The continued cooking settings with a dot after the number are only available if the power level range has been extended (see "Programming - P2").

Use

Activating Auto-heat

- Press the - sensor until the desired continued power level appears, e.g. 5.

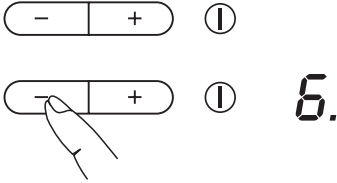

During the heat-up time a dot will light to the right of the continued power level, and go out when it is completed.

At any point during the Auto-heat time you can use + or - to lower or increase the continued power level. The Auto-heat time will adjust accordingly.

In the **extended** range of settings (see "Programming - P2"), **A** flashes alternately with the continued power level until the heat-up time has completed.

Booster function

Each burner is equipped with a booster function to temporarily increase the power level. The front left burner is equipped with a double booster.

When the booster function is on, the burners increase to power level **9** for 10 minutes. This boost is intended quickly bring large quantities of water to the boil, e.g. when cooking pasta. A maximum of two booster functions can be used at one time.

If the booster is activated, when

- no power setting is selected, the burner will revert to power level 9 at the end of the booster time or when the booster is switched off.
- a power setting is selected, the burner will revert to this pre-selected power setting at the end of the booster time or when the booster is switched off.

Taking a pan off the burner while the booster is in operation interrupts the booster function. It will resume if a pan is placed back on the burner within 3 minutes.

The booster can be switched off by touching the **+** and **-** sensor at the same time, or by touching the **-** sensor.

The extra boost of energy is only available by taking a proportion of energy away from another burner. For this reason, the burners are networked in pairs as shown.

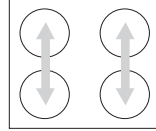

When the booster is activated:

- if Auto-heat is activated or either burner of the same network, it will switch off.
- the power level on the other linked burner may decrease.
- if the rear left burner is turned on, it will switch off if booster 2 for the front left burner is activated.

Use

Single booster (all burners)

- Turn on the relevant burner.
- Select a power level.
- Take your finger off the sensor.
- Touch the + and - sensor briefly at the same time.

The indicator for the booster will light and *!* will appear in the burner display.

If power level 9 was selected, the booster can be activated by touching the + sensor only.

Double booster (front left burner only)

- Turn on the relevant burner.
- Select a power level.
- Take your finger off the sensor.
- Touch the + and - sensor briefly at the same time.

The indicator for the booster will light and *!* will appear in the burner display.

- Touch the + and - sensor briefly at the same time again.

// will appear in the burner display.

Turning off a burner

- Touch the ① On/Off touch control for the desired burner.

The display will show - for a few seconds. If the burner is still hot the residual heat indicator will show.

Turning off the cooktop

- Touch the ① On/Off control for the cooktop.

All burners are turned off. If any burners are still hot the residual heat indicator will show in the respective display.

Residual heat indicator

The bars of the residual heat indicator go out one after another as the burners cool. The last horizontal line only goes out when the burner is safe to touch.

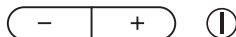

The residual heat indicator also reacts to hot dishes and plates being placed on a burner that is not switched on.

Do not touch any burner or place any heat sensitive items on a burner where the residual heat indicator is lit. Danger of burns, and fire hazard.

 Please note that the residual heat indicators do not light when there is a fault message, even if the burners are hot.

Timer

The cooktop is fitted with a timer which can be used to time kitchen activities and/or to switch off the burners automatically.

You can set a time from 1 minute (**01**) to 9 ½ hours (**9.h**). If the time is more than 99 minutes (**99**), the setting will be shown in half-hour increments, which appear after the decimal point.

Use the - and + touch controls to raise and lower the time. There are pre-set stops at 2 hours and at 99 minutes. To override a stop, briefly remove your finger from the touch control, then touch it again to continue.

To re-set the display to **00**, simultaneously touch - and +.

When the set time has elapsed, **00** will appear in the timer display for a few seconds. At the same time an audible signal will sound for a few seconds. To turn the signal off before this, touch the ⊖ sensor.

Setting the timer

The timer can be used with the cooktop turned on or off. It works like a manual kitchen timer.

- Touch the ⊖, - or + sensor.

Two dashes appear in the display, and the timer indicator will flash.

- While the indicator is flashing, touch the - or + sensor until the desired time appears in the display, e.g. 15 minutes.

The time then counts down in minutes. The time remaining can be seen in the display and changed at any time by touching - or +.

Automatic switch-off

To use this feature, a power setting must be selected for the desired burner. All burners can be programmed at the same time.

If the programmed time is greater than the maximum operating hours permitted, the cooktop will eventually switch-off automatically. See "Safety cut-out feature" for more information".

- Turn the desired burner on, e.g. rear right, and select a power level.
- Touch the ⊖ sensor.

Two dashes appear in the display, and the timer indicator will flash.

- Touch the ⊖ sensor again.

The indicator for the timer in the display goes out, and the automatic switch-off indicator flashes.

- If several burners are being used, touch the ⊖ sensor repeatedly until the indicator flashes next to the burner you wish to use this function for, e.g. back right.

The indicator for the burners being used will light up clockwise, starting with the front left.

- Touch the - or + sensor until the desired time appears in the display, e.g. 15 minutes.

The time then counts down in minutes. The time remaining can be seen in the display and changed at any time by touching - or +.

If you want to set another burner to switch-off automatically, repeat the same steps.

If more than one switch-off time is programmed, the shortest time remaining will show in the display, the indicator for that particular burner will flash. All the other indicators will remain lit. If you want to check the remaining time for another zone, touch the ⊖ sensor until the indicator for the desired burner flashes.

Timer

Combi mode

The timer and automatic switch-off functions can be used at the same time.

If you have programmed in one or more switch-off times, and would like to use the **timer as well**:

Touch the ⊖ sensor repeatedly until the timer indicator flashes.

If you are using the timer, and would like to program one or more switch-off times **as well**:

Touch the ⊖ sensor repeatedly until the indicator flashes for the desired burner.

After the last entry, the shortest remaining time will appear in the display. If you want to check on another remaining time, touch the ⊖ sensor until the relevant indicator flashes.

Starting with the shortest remaining time which is shown in the display, all burners that are in use and the timer can be selected clockwise.

Child Safety Lock

Keep children away from the cooktop for their own safety.

The cooktop has a Child Safety Lock to prevent children from turning on the burners or changing settings.

The Child Safety Lock can be activated while the cooktop is on or off.

Activating the Child Safety Lock during cooktop use

- The settings for the burners and timer cannot be altered.
- The burners and cooktop can still be turned off but once turned off cannot be turned on again.

Activating the Child Safety Lock when the cooktop is turned off

- The cooktop cannot be turned on.

The indicator will come on to show that the Child Safety Lock has been activated, if you touch the  Child Safety Lock control or try to select a setting.

Manual activation

- Press and hold the  Child Safety Lock control until the respective indicator lights.

The indicator will go out after a short time.

You can alter the setting from one finger to three finger operation (see "Programming - P6") to make it harder for children to operate the appliance.

Automatic activation

The Safety lock will come on 5 minutes after the cooktop is switched off.

To use this feature the setting has been changed (see "Programming - P7").

Deactivation

- Press and hold the  Child Safety Lock control until the indicator goes out.

In the case of a power failure the Child Safety Lock will be deactivated.

Safety features

Stop and Go



Your appliance has a Stop and Go feature which, when activated, reduces the power of all burners that have been switched on.

If you then deactivate the feature, the burners will automatically return to the previous level.

If the feature is not deactivated, the cooktop will turn off after 1 hour.

If you wish to use this feature, you will need to alter the factory setting (see "Programming - P1").

To activate Stop and Go:

- Press and hold the sensor  until you hear two consecutive beeps. Be careful not to continue touching the  sensor for too long, as this will activate the safety lock.

The Child Safety Lock indicator will flash. The power for the activated burner(s) will reduce to level 1, and 1 will appear in the respective display.

When activating "Stop and Go":

- the countdown of the programmed time for the automatic switch-off function will be interrupted. When deactivating "Stop and Go", the countdown will continue,
- the timer will continue without interruption.

To deactivate Stop and Go:

- Press and hold the  control until the indicator goes out.

The burners will now run at the level previously set.

Safety cut-out feature

The cooktop is on too long

The cooktop has a safety cut-out feature in case it is not turned off after use.

If one of the burners is heated for an unusually long period of time (see table), and the power level settings are not adjusted, the cooktop will turn itself off automatically and the residual heat indicator will light.

Power level*	Maximum operating hours
1 / 1.	10
2 / 2.	5
3 / 3.	5
4 / 4.	4
5 / 5.	3
6 / 6.	2
7 / 7.	2
8 / 8.	2
9	1

* The power settings with a dot after the number are only available if the power setting range has been extended (see "Programming - P2.").

- To use the burners again, turn the cooktop back on in the usual way.

Covered touch controls

The cooktop will turn off automatically if any of the touch controls are covered for more than 10 seconds, e.g. by finger contact, food boiling over or by an object such as an oven mitt or towel. A tone will also sound every 30 secs. for a maximum of 10 min and an **F** will flash in the display of the sensor which is covered.



- Clean the touch controls or remove the object covering it.

This will turn off the signal tone and the displayed **F** will go out.

- Turn the cooktop on again with the ① touch control. The burners can now be used.

Safety features

Overheating protection

The induction coils and the cooling element of the electronic are fitted with a overheating protection feature. This prevents the induction coils and cooling element from overheating.

This mechanism works on the affected burner or on the entire cooktop in the following ways:

- If the booster function is being used, this will be switched off.
- The power level will be reduced.
- If an induction coil is affected, the cooktop will switch off. The fault code **FE99** will be displayed.

The burner can be used again as soon as it has cooled to a safe temperature.

- If the cooling element is affected, the power supply to the burners will be reduced, and the set power level will continue to be displayed.

As soon as the cooling element has cooled sufficiently, the burners will automatically continue to operate at the original power setting.

Overheating can be caused by:

- heating an empty pan.
- fats or oils being heated on the highest power setting.
- there being insufficient ventilation to the under side of the appliance.

If the overheating protection mechanism triggers again, contact Miele Technical Service.

Do not use a steam cleaner to clean this appliance. Steam could penetrate electrical components and cause a short circuit. Pressurized steam could cause permanent damage to the surface and to components for which the manufacturer cannot accept responsibility.

Do not use any sharp pointed objects which could damage the seal between the ceramic surface, the surrounding frame and the countertop.

Never use abrasive or caustic (oven) cleaners, dishwasher detergent, scouring pads, steel wool or hard brushes. They will damage the surface.

The ceramic surface can be cleaned using a cleaner for ceramic surfaces. Follow the manufacturer's instructions.

Make sure that no cleaner residue remains on the ceramic surface by carefully wiping the cooktop with a damp cloth. They may damage the cooktop or produce toxic fumes when heated.

Be sure that pot and pan bases are clean and dry.

After cleaning, dry the ceramic surface with a soft cloth to prevent a build up of limescale deposits.

Clean any spills immediately before they become difficult to remove.

Clean the appliance regularly, preferably after each use. Allow the appliance to cool before cleaning.

- Wipe off any soiling using a damp cloth. Stubborn soiling is best removed with a shielded scraper blade.
- Apply a ceramic cleaner using a soft cloth or paper towel. To remove any limescale deposits or metallic residue apply a ceramic cleaner using a soft cloth and a shielded scraper blade if necessary.
- After cleaning wipe the ceramic surface with a damp cloth and dry.

A cleaner with a special additive to prevent water marks and smears on the ceramic surface may be used.

Any melted solids like **sugar, plastic or aluminum foil** should be removed as soon as possible, while the burner is still warm. If they are allowed to harden the cooktop may become pitted.

- Turn the burner off.
- Using a shielded scraper blade, scrape the melted item **immediately** off the burner while it is still hot. Use caution: Danger of burns!
- Allow the cooktop to cool and clean as previously described.

Programming

The cooktop's default settings can be adjusted (see table).

- While the cooktop is turned off, touch the On/Off "Ⓢ" control and Child Safety Lock "🔒" control at the same time until the Child Safety Lock indicator flashes.

The burner display shows *P* (Program) and *S* (Status) with a number. The number indicates the current setting.

To set the desired program:

- Touch the **+** or **-** control of the **front left** burner to select the program desired.

To set the status (see table):

- Touch the **+** or **-** control of the **front right** burner to select the desired status.

Several programs can be adjusted one after another by repeating the steps listed above.

Saving the settings

- Press and hold the On/Off "Ⓢ" touch control until the displays go out.

Not saving the settings

- Press and hold the Child Safety Lock "🔒" control until the displays go out.



Programming Table

Program*	Status**	Setting
P 0 Demonstration mode and factory default settings	S 0	Demonstration mode on
	S 1	Demonstration mode off
	S 9	Restore Factory default settings
P 1 Stop and Go	S 0	Off
	S 1	On
P 2 Power level range	S 0	9 power levels (1 to 9)
	S 1	17 power levels (1, 1., 2, 2., 3 ... to 9) If the Auto heat setting is selected, an <i>H</i> will flash alternately with the continued power level in the display
P 3 Warning tone when there is no pan or the pan is unsuitable	S 0	Off
	S 1	Quiet
	S 2	Medium
	S 3	Loud
P 4 Keypad tone when a control is touched	S 0	Off
	S 1	Quiet
	S 2	Medium
	S 3	Loud
P 5 Timer tone volume	S 0	Off
	S 1	Quiet - 10 seconds
	S 2	Medium- 10 seconds
	S 3	Loud - 10 seconds

* Programs / status not shown are not allocated.

** The factory default setting is printed in bold.

Programming

Program*		Status**		Setting
P 6	Safety lock manual activation procedure	S 0	One finger lock using 	
		S 1	Three finger lock using  and + on the two right-hand burners	
P 7	Safety lock activation	S 0	Manual activation	
		S 1	Automatic activation 5 minutes after cooktop is turned off	
P 8	Auto heat	S 0	Off	
		S 1	On	
P 6.	Sensor reaction time	S 0	Low	
		S 1	Normal (300 ms)	
		S 2	Fast	

* Programs / status not shown are not allocated.

** The factory default setting is printed in bold.

Frequently asked questions

Repairs should only be carried out by an authorized technician in accordance with local and national safety regulations. Unauthorized repairs could cause injury or appliance damage. The manufacturer cannot be held responsible for unauthorized work.

What if the cooktop or the burners cannot be turned on?

Possible fault	Solution
The cookware is not suitable for an induction cooktop.	Use the correct pots and pans, see "Cookware".
The Child Safety Lock is activated.	Deactivate the safety lock. See "Child Safety Lock".
The main fuse has blown.	Check the main fuse.

What if the burner does not heat up but can be turned on and a power level can be selected?

Possible fault	Solution
The cooktop is in the demo mode.	See "Programming - P0".

What if a appears in a burner display?

Possible fault	Solution
The burner was turned on without a pan on it.	Be sure the correct burner is turned on and a pan is on it.
The cookware is not suitable for an induction cooktop.	Use the correct pots and pans, see "Cookware".

What if a single burner or the whole cooktop switches itself off?

The Safety cut-out or Overheating protection feature has been activated. See "Safety features".

What if food does not cook when using auto-heat?

Possible fault	Solution
The pot or pan does not transfer heat properly.	Use the correct pots and pans, see "Cookware".
Large amounts of food are being cooked.	Select a higher continued power level.

Frequently asked questions

What if one of the following has occurred?

Possible fault	Solution
The booster has automatically switched off early.	The overheating protecting feature has been triggered, see "Safety features".
The power level has dropped.	
The burner is not working as usual.	

What if the cooling fan continues to run after the appliance has been switched off?

This is not a fault. The fan will continue running until the appliance has cooled. It will then switch itself off automatically.

What if an *F* appears in the display for the rear burners, an *E* appears in the display for the front burners and numbers appear in the timer display

Possible fault	Solution
<i>FE99</i>	The overheating protection mechanism has triggered. The burner can be used again as soon as it has cooled down to a safe level.
Other fault messages	Interrupt the power supply to the cooktop for approx. 1 minute.
	If the problem persists after reconnecting the appliance to the power supply, please contact the Miele Technical Service department.

In the event of a fault which you cannot easily fix yourself, please contact the Miele Technical Service Department using the information on the back of this manual.

When contacting Technical Service quote the serial number and model of the cooktop. This information is visible on the silver data plate.

MieleCare

(USA only)

MieleCare, our Extended Service Contract program; gives you the assurance of knowing that your appliance investment is covered by 5 years of worry free ownership.

MieleCare is the only Extended Service Contract in the industry that guarantees repairs by a Miele Authorized Service Provider using genuine Miele parts. Only genuine Miele parts installed by factory trained professionals can guarantee the safety, reliability and longevity of your Miele appliance.

Please note that unless expressly approved in writing by the Miele Service department, Extended Service Contracts offered by other providers for Miele products will not be recognized by Miele. Our goal is to prevent unauthorized (and untrained) service personnel from working on your Miele products, possibly doing further damage to them, you and/or your home.

To learn more about **MieleCare** Extended Service Contracts, please contact your appliance dealer or visit us online at:

<http://store.miele.com>

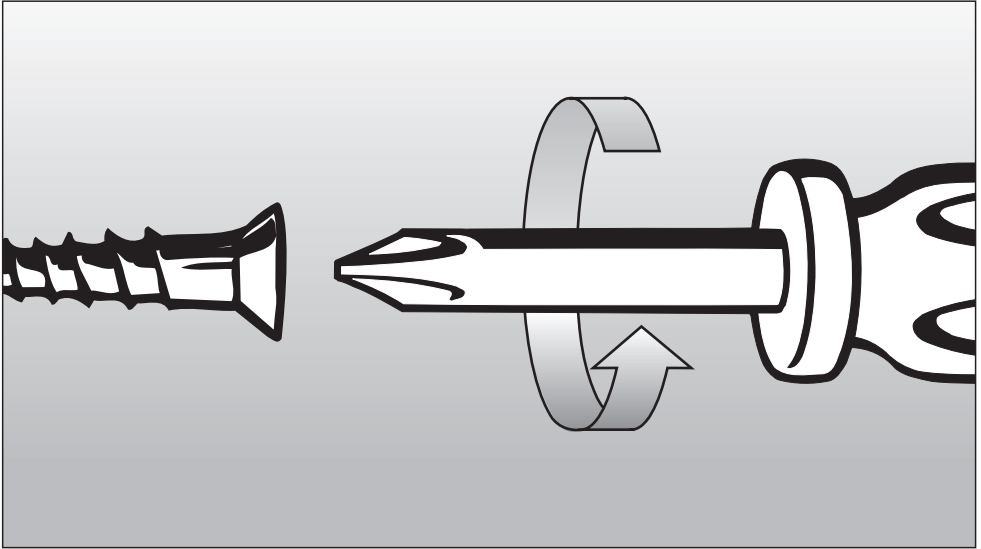

Installation Instructions

IMPORTANT: SAVE FOR THE LOCAL ELECTRICAL INSPECTOR'S USE

To prevent accidents
and machine damage
read these instructions
before
installation or use.

IMPORTANT SAFETY INSTRUCTIONS

Note to the installer:

Please leave this instruction book with the consumer for the local electrical inspector's use.

The minimum distances given in these Installation Instructions must be observed in order to ensure safe operation. Failure to do so increases the risk of fire.

The cabinetry and venting hood should be installed first to prevent damage to the cooktop.

► The cooktop should only be installed as shown in the illustrations while maintaining the required safety distances shown. Do not install the cooktop between two tall cabinets, this is a fire hazard.

① A minimum distance of 2" (50 mm) from the cooktop to the rear wall and a side wall or cabinet must be maintained for safety.

► The countertop must be bonded with heat resistant (212 °F/100 °C) adhesive to prevent distortion or dissolving.

► The cooktop must not be installed over a dishwasher, washer, dryer, refrigerator or freezer. Heat radiated by the cooktop may damage them.

► The cooktop must only be installed above an oven if it has a built-in cooling fan.

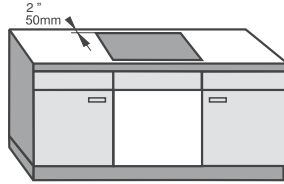
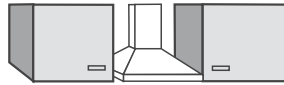

recommended

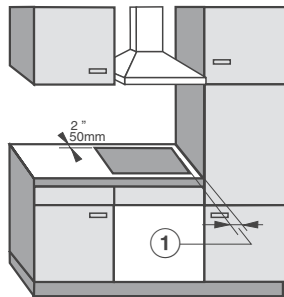

not recommended

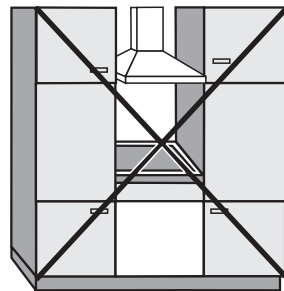

not allowed

IMPORTANT SAFETY INSTRUCTIONS

► To eliminate the risk of burns or fire by reaching over heated surfaces cabinet storage space above the cooktop should be avoided. If cabinet storage is necessary, the risk can be reduced by installing a venting hood to project horizontally a minimum of 5" (127 mm) beyond the bottom of the cabinets.

► Because of the heat radiated it is not recommended to install the cooktop above a drawer. It should be installed above a cabinet base unit with a dummy drawer front. A protective base should also be installed between the dummy drawer and the cooktop. There must be a minimum distance of 4 ½" (110 mm) between the top of the countertop and the top of the protective base to ensure proper ventilation.

► This appliance has not been designed for maritime use or for use in mobile installations such as recreational vehicles or aircraft. However, under certain conditions it may be possible for installation in these applications. Please contact the Miele Technical Service Department with specific requirements.

► The cooktop must not be permanently sealed into the countertop when installed. The sealing strip under the edge of the cooktop provides a sufficient seal for the countertop.

► Once installed, be sure that the power cord cannot come into contact with the underside of the cooktop or any mechanical parts.

Safety distances above the appliance

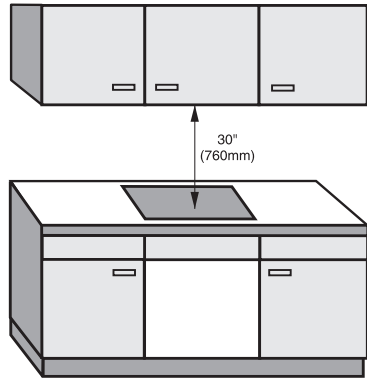

The minimum safety distance given by the hood manufacturer must be maintained between the cooktop and the hood above it. See the installation instructions of the hood for these safety measurements.

If the hood manufacturers instructions are not available or if flammable objects are installed over the cooktop (e.g. cabinets, utensil rail, etc.), a minimum safety distance of 30" (760 mm) must be maintained.

If there is more than one appliance beneath a hood (e.g. wok burner and electric cooktop), and they have different minimum safety distances always observe the greater distance.

Installation

Cooktops flush with the countertop

Frame/Facet cooktops

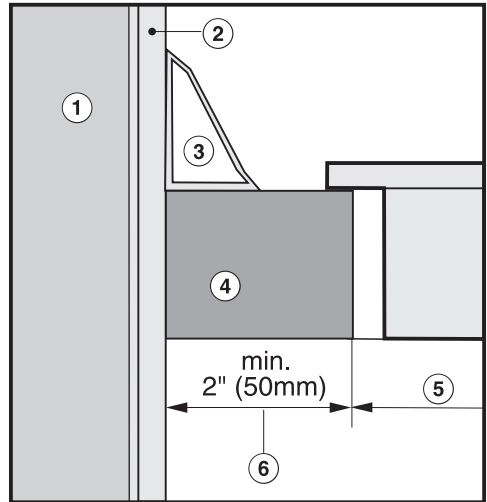
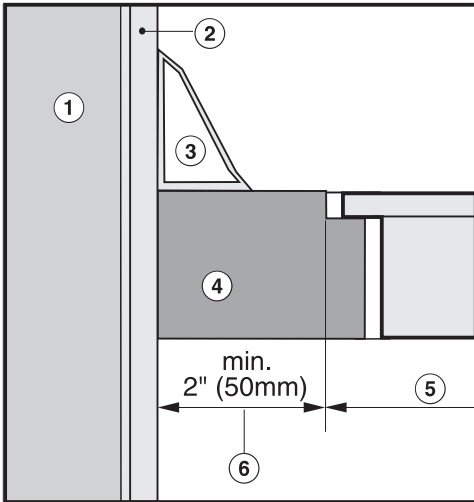

- ① Wall
- ② Wall covering
- ③ Back splash
- ④ Countertop
- ⑤ Countertop cut-out
- ⑥ 2" (50 mm) minimum distance

Installation dimensions

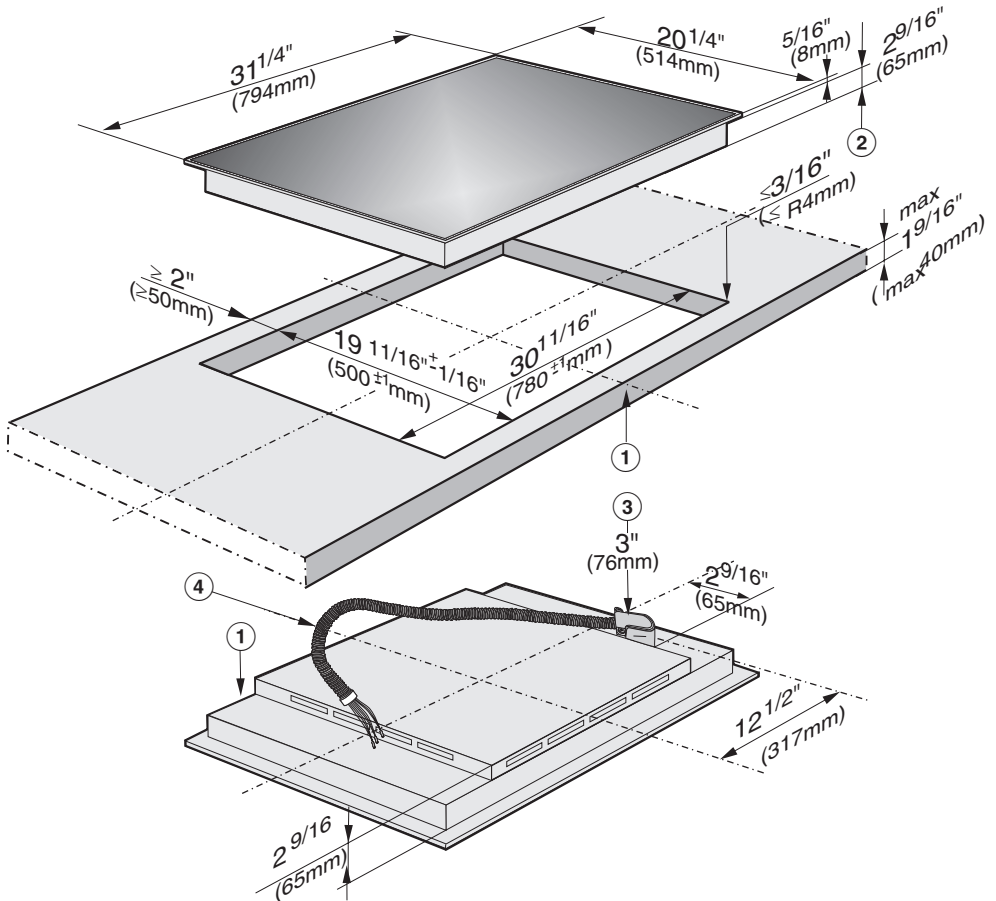

- ① Front of cooktop
- ② Installation height
- ③ Installation height power supply
- ④ Power cord encased by flexible metal conduit
Length = 3' 11" (1200 mm) $\varnothing = \frac{3}{4}''$ (19 mm)

Installation

Ventilation

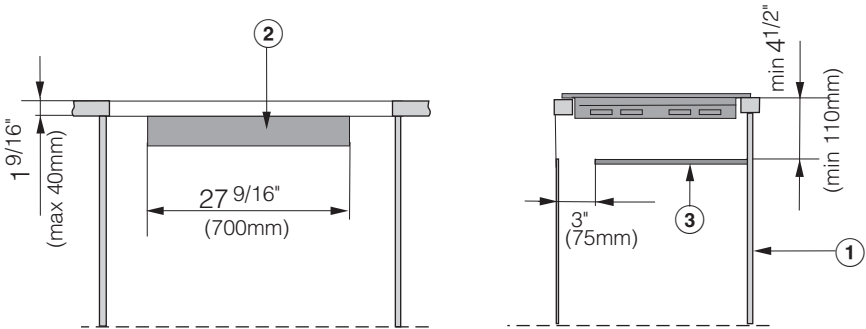

- ① Front of cooktop
- ② Cut-out at the rear wall of the cabinet for ventilation

③ Protective base

If a protective base is fitted, there must be a distance of at least 4 ½" (110 mm) between the top of the protective base and the top of the countertop, for proper ventilation of the appliance. At the back there has to be a gap of 3" (75 mm) for the power cord.

Cut out

- Make the countertop cut-out following the dimensions given in the illustration.

Remember to maintain a minimum distance of 2" (50 mm) between the rear wall and the right or left side. See also the "IMPORTANT SAFETY INSTRUCTIONS".

- Seal the cut surfaces with a suitable heat-resistant sealant to avoid swelling caused by moisture.

If during installation the seal around the frame does not sit flush with the countertop in the corners, the corner radius, maximum $\frac{3}{16}$ " (4 mm), can be carefully filed down to fit.

This cooktop has a seal underneath to keep it securely in position. Spring clips are not required. Any gap between the frame and the countertop will reduce as the cooktop is used.

Installing the cooktop

- Feed the cooktop connection cable down through the cut-out.
- Place the cooktop centrally in the cut-out. When doing so make sure that the seal under the cooktop sits flush with the countertop on all sides. This is important to ensure an effective seal. **Do not use sealant.**
- Connect the cooktop to the main power supply.
- Turn the cooktop on and check the function.

Installation

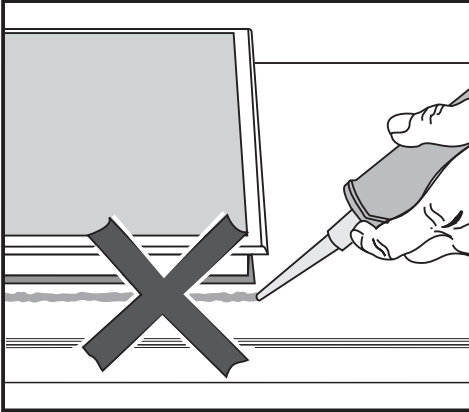

The cooktop must not be permanently sealed into the countertop when installed. The sealing strip under the edge of the cooktop provides a sufficient seal for the countertop.

If the cooktop is sealed into position, the countertop or appliance could be damaged if the cooktop needs to be removed for maintenance or service.

 **CAUTION:** Before installation or servicing, disconnect the power supply by either removing the fuse, shutting off the main power supply or manually "tripping" the circuit breaker.

Installation work and repairs should only be performed by a qualified technician in accordance with all applicable codes and standards. Repairs and service by unqualified persons could be dangerous and the manufacturer will not be held responsible.

Before connecting the appliance to the power supply, make sure that the voltage and frequency listed on the data plate correspond with the household electrical supply. This data must correspond to prevent appliance damage. Consult an electrician if in doubt.

Only operate the cooktop after it has been installed into the countertop.

Installer:

Please leave these instructions with the consumer.

Power supply

- Be sure your electrical supply matches the data plate.

Connection

The cooktop is equipped with a flexible metal conduit encasing 3 wires ready for connection to a grounded power supply.

208/240 V, 60 Hz, 40 A fuse rating.

Black wire: connect to L1 (hot)

Red wire: connect to L2 (hot)

Green wire: connect to GND (ground)

A dedicated line and junction box should be used to connect the cooktop to a 40 A circuit.

For further information, see the wiring diagram provided with the appliance.

 **WARNING:**
THIS APPLIANCE MUST BE GROUNDED!

Help protect our environment

Disposal of packing materials

The cardboard box and packing materials are biodegradable and recyclable. Please recycle.

Ensure that any plastic wrappings, bags, etc. are disposed of safely and kept out of the reach of children.

Danger of suffocation!

Disposal of an old appliance

Old appliances contain materials that can be recycled. Please contact your local recycling authority about the possibility of recycling these materials.

Before discarding an old appliance disconnect it from the electrical supply and cut off the power cord to prevent it from becoming a hazard.

**Please have the model and serial number
of your appliance available before
contacting Technical Service.**



**U.S.A.
Miele, Inc.**

National Headquarters

9 Independence Way
Princeton, NJ 08540
Phone: 800-843-7231
609-419-9898
Fax: 609-419-4298
www.miele.com

**Technical Service & Support
Nationwide**

Phone: 800-999-1360
Fax: 888-586-8056
TechnicalService@mieleusa.com

**Canada
Miele Limited**

Headquarters and Showroom

161 Four Valley Drive
Vaughan, ON L4K 4V8
Phone: 800-643-5381
905-660-9936
Fax: 905-532-2290
www.miele.ca
info@miele.ca (general enquiries)
professional@miele.ca (commercial enquiries)

MieleCare National Service

Phone: 800-565-6435
905-532-2272
Fax: 905-532-2292
service@miele.ca (technical enquiries)