

JX510P JX210P

User's Guide

Table of Contents

Introduction	2
Before Using Your Machine	10
Copying	22
Sending Faxes	23
Receiving Faxes	32
Using TAM Mode (JX510P only)	42
Printing from Your Computer	53
Settings and Activity Reports	55
Routine Maintenance	62
Troubleshooting	72
Specifications	92



This equipment conforms with the essential requirements of EC Directive 1999/5/EC.

(For Europe Only)

European Union (and EEA) only.



These symbols indicate that this product is not to be disposed of with your household waste, according to the WEEE Directive (2002/96/EC), the Battery Directive (2006/66/EC) and/or your national laws implementing those Directives.

This product should be handed over to a designated collection point, e.g., on an authorized one-for-one basis when you buy a new similar product or to an authorized collection site for recycling waste electrical and electronic equipment (EEE) and batteries and accumulators. Improper handling of this type of waste could have a possible impact on the environment and human health due to potentially hazardous substances that are generally associated with EEE.

Your cooperation in the correct disposal of this product will contribute to the effective usage of natural resources.



For more information about the recycling of this product, please contact your local city office, waste authority, approved scheme or your household waste disposal service or visit www.canon-europe.com/environment.

(EEA: Norway, Iceland and Liechtenstein)

For Customers in Europe, Middle-East, Africa and Russia only

For Canon Customer Support contacts, please see the European Warranty System (EWS) or visit www.canon-europe.com.



AF46

Model Name

K10334 (JX510P/JX210P)

About Consumables

Consumables (ink tanks / FINE Cartridges) are available for 5 years after production has stopped.

International ENERGY STAR® Program



As an ENERGY STAR Partner, Canon Inc. has determined that this product meets the ENERGY STAR guidelines for efficiency.

Depending on your application program, operations may differ. For details, refer to the instruction manual of your application. The steps described in this manual are in Windows Vista operating system Ultimate Edition (hereafter referred to as "Windows Vista").

Trademark Notices

- Microsoft is a registered trademark of Microsoft Corporation.
- Windows is a trademark or registered trademark of Microsoft Corporation in the U.S. and/or other countries.
- Windows Vista is a trademark or registered trademark of Microsoft Corporation in the U.S. and/or other countries.
- Macintosh is a trademark of Apple Inc., registered in the U.S. and other countries.

© **CANON INC. 2009**

All rights reserved. No part of this publication may be transmitted or copied in any form whatsoever without the express written permission.

Introduction

Useful Information

● Replacing a FINE Cartridge

When the ink in the FINE Cartridge starts to run out, the machine will switch to memory reception of faxes.

See "Printing a Document in Memory" on page 40

See "Replacing a FINE Cartridge" on page 64

See "Aligning the FINE Cartridge" on page 67

● One-touch and Coded Dial Numbers

You can register One-touch and Coded Dial numbers in your fax machine to make sending faxes easier and faster.

See "Registering One-touch Speed Dialing Numbers and Names" on page 17

See "Registering Coded Speed Dialing Numbers and Names" on page 18

● Different Ways to Receive Faxes

There are several different ways to receive faxes using this machine. Select the one that most suits your needs.

See "Setting the Receive Mode" on page 33

● Deleting Faxes from the Memory

When the ink level is low faxes will be received into the memory. Once 30 transmissions have been received reception will no longer be possible, so be sure to print out and delete unnecessary faxes from the memory.

See "Printing All Unprinted Documents in Memory" on page 40

See "Deleting All Printed Documents from Memory" on page 41

● Deleting Messages from the Memory

Answering machine messages are also stored in the machine's memory. Again delete unnecessary messages to free up memory for new messages.

See "Deleting Messages" on page 46

● Clearing Documents and Paper Jams

In the unlikely event that your machine jams you will need to remove the jammed paper.

See "Paper Jams" on page 72

● Setting the Telephone Line Type

To use a fax or make a telephone call, you need to set the telephone line type setting properly on the machine. If you are unsure of your telephone line type, contact your telephone company.

See "Setting the Telephone Line Type" on page 14

● Receiving to Memory Temporarily (<AUTO PRINT OFF>)

You can configure not to print received faxes automatically. Set the <AUTO PRINT> setting to <OFF> to store received faxes in the machine's memory.

See "Receiving to Memory Temporarily" on page 37

Reading the Documentation

This guide provides detailed information on how to set up, operate, maintain, and troubleshoot your fax.

Please read the list below to become familiar with the symbols, terms, and abbreviations used in this guide.

Warning

Indicates a warning concerning operations that may lead to death or injury to persons if not performed correctly. In order to use the machine safely, always pay attention to these warnings.

Caution

Indicates a caution concerning operations that may lead to injury to persons or damage to property if not performed correctly. In order to use the machine safely, always pay attention to these cautions.

Important

Indicates operational warnings and restrictions. Be certain to read these items to operate the machine correctly and to avoid damage to the machine.

Note

Indicates notes for operation or additional explanations. Reading these is highly recommended.

(see page xx)	Indicates a page number that you can refer to for more information on the topic of the previous sentence or paragraph.
default	A setting that remains in effect unless you change it.
document	The original sheet(s) of paper you send, receive, or copy with your fax.
menu	A list of settings from which you select an item to set up or change. A menu has a title which appears on the LCD.
[▲] and [▼] buttons	Used to select an item in a menu. Press [▼] to select the next item, and press [▲] to select the previous item.
transaction number	When you send or receive a document, your fax automatically assigns the document a unique transaction number. A transaction number is a four-digit number that will help you keep track of documents you send and receive.
TX/RX NO.	TX/RX NO. is the abbreviation used for “transaction number.”
TX	Denotes Transmission.
RX	Denotes Reception.
<div style="border: 1px solid black; padding: 2px; display: inline-block;">TRANSMITTING OK</div>	LCD display. The contents of the LCD display may vary depending on the current settings.

In addition, this guide uses brackets to identify the buttons you press when performing different functions: [Stop/Reset].

Note

This guide contains information for two Canon models. Please note that the illustrations of the fax in this guide may differ from your model. Instructions for specific models are labelled with the fax names.

⚠ Safety Precautions

Please read the safety warnings and cautions provided in this manual to ensure that you use the machine safely. Do not attempt to use the machine in any way not described in this manual.

⚠ Warning

- This product emits low level magnetic flux. If you use a cardiac pacemaker and feel abnormalities, please move away from this product and consult your doctor.
- You may cause an electric shock, fire, or damage the machine if you ignore any of these safety precautions.

Choosing a location	Do not place the machine close to flammable solvents such as alcohol or thinners.
Power supply	Never attempt to plug in or unplug the machine from the power supply when your hands are wet.
	Always push the plug all the way into the power outlet.
	Never damage, modify, stretch or excessively bend or twist the power cord. Do not place heavy objects on the power cord.
	Never plug the machine into a power socket that is shared with other equipment (extension lead/cord, 2- or 3-way adapter, etc.).
	Never use the machine if the power cord is bundled or knotted.
	If you detect smoke, unusual smells or strange noises around the machine, immediately unplug the machine at the power supply and call for service.
	Periodically, unplug the machine and use a dry cloth to wipe off any dust or dirt collected on the plug and the power outlet. If the machine is placed at a location exposed to a lot of dust, smoke, or high humidity, the dust collected on the plug absorbs moisture and may cause insulation failure and fire.
	If you hear thunder, disconnect the power supply of the machine and refrain from using it. Leaving the machine plugged in may cause fire, electric shock, or damage to the machine, depending on the thunder storm.
Never use a power supply source other than the one rated for the machine in the country of where you purchased the machine. AC 100-240 V, 50/60 Hz	
Cleaning the machine	Use a damp cloth to clean the machine. Never use flammable solvents such as alcohol, benzene or thinners. If flammable solvents come in contact with electrical components inside the machine, it could cause a fire or electric shock.
	Always unplug the machine from the power outlet before cleaning the machine. If you accidentally switch the machine on while cleaning it, you could injure yourself or damage the machine.
Maintaining the machine	Do not attempt to disassemble or modify the machine. There are no user serviceable parts inside the machine. The machine contains high-voltage components. Never attempt any maintenance procedure not described in this guide.
Working around the machine	Do not use highly flammable sprays near the machine. This could cause a fire or electric shock if the spray comes into contact with electrical components inside the machine.

⚠ Caution

You may cause injury or damage the machine if you ignore any of these safety precautions.

Choosing a location	Do not install the machine in a location that is unstable or subject to excessive vibration.
	Do not install the machine in locations that are very humid or dusty, in direct sunlight, outdoors, or close to a heating source.
	To avoid the risk of fire or electric shocks, install the machine in a location with an ambient temperature range of 5°C to 35°C (41°F to 95°F) and humidity of 10% to 90% (condensation free).
	Do not place the machine on a thick rug or carpet.
Power supply	Do not place the machine with its back attached to the wall.
	Ensure that the area around the power outlet is kept clear at all times so you can easily unplug the power cord if necessary.
	Never remove the plug by pulling on the cord.
Working around the machine	Do not use an extension lead/cord.
	Never put your hands or fingers in the machine while it is printing.
	Do not place any object on the machine.
	Do not place metal objects (paper clips, staples, etc.) or containers of flammable solvents (alcohol, thinners, etc.) on top of the machine.
	If any foreign object (metal or liquid) fall into the machine, unplug the power cord and call for service.
FINE Cartridge (Ink Cartridge)	Do not transport or store the machine on a slant, vertically or upside-down, as the ink may leak and damage the machine.
	Keep FINE Cartridges (Ink Cartridges) out of the reach of children.
	In case ink is accidentally licked or swallowed, rinse out mouth or give one or two glasses of water to drink.
	If irritation or discomfort occurs, obtain medical advice immediately.
	In case ink gets in contact with eyes, rinse with water immediately.
	In case ink gets in contact with skin, wash with soap and water immediately.
If irritation to eyes or skin persists, obtain medical advice immediately.	
	Never touch the electrical contacts on a FINE Cartridge (Ink Cartridge) after printing. The metal parts may be very hot and could cause burns.
	Do not throw FINE Cartridges (Ink Cartridges) into fire.

Legal Limitations

It may be unlawful to make copies of, scan, print, or use reproductions of the following documents. The list provided is non-exhaustive. When in doubt, check with a legal representative in your jurisdiction.

- Paper money
- Money orders
- Certificates of deposit
- Postage stamps (canceled or uncanceled)
- Identifying badges or insignias
- Selective service or draft papers
- Checks or drafts issued by governmental agencies
- Motor vehicle licenses and certificates of title
- Traveler's checks
- Food stamps
- Passports
- Immigration papers
- Internal revenue stamps (canceled or uncanceled)
- Bonds or other certificates of indebtedness
- Stock certificates
- Copyrighted works/works of art without permission of copyright owner

How to Use the Documentation Provided



Setup Sheet

Be sure to read this sheet first.

This sheet includes instructions for setting up your machine and getting it ready for use.



User's Guide (This guide)

Read this guide when starting to use the machine.

After following instructions in your setup sheet, we recommend you read this guide to familiarize yourself with the basic operation of some of the main functions that can be performed on your machine.



On-screen Manual

Read this guide when printing from your computer.

Please refer to the *On-screen Manual* for full instructions on printing a document from your computer, and printer driver setting. This manual can be installed from the *Setup CD-ROM*.

Preparing the Machine

Be sure to read your setup sheet first for setting up your machine and getting it ready for use.

Unpack the machine

Please confirm the included items against the illustration printed on the lid of the packing box.

Important

A USB cable is necessary to connect the machine with your computer.

1 Connect the telephone line and the power cord.

Be sure to use the bundled telephone line cable.

If you connect the telephone line, see your setup sheet.

Remove the Telephone connector protective tape to connect the external device.

Users in Europe

If you prepare your own phone cable, be sure it is a 6-wire phone cable.

Users in the UK

If the connector of the external device cannot be connected to the jack on the machine, you will need to purchase a B.T. adapter to connect as follows:

Connect the external device line to the B.T. adapter, then connect the B.T. adapter to the  jack.

Important

Be sure to remove the tapes and protective material before you turn on the machine.

Note

The tape or the protective material position is subject to change.

2 Turn on the machine.

Note

- If an unintended language is displayed on the LCD, press [Stop/Reset], then change it into your desired language. See "Selecting the Language for the LCD" on page 8.
 - The country selection is only available for some countries.
-

3 Prepare the FINE Cartridge.

Caution

- Do not touch internal parts other than the Holder.
- Do not drop or shake FINE Cartridge as this may cause the ink to leak out and stain your clothes and hands.

Important

- Do not touch the electrical contacts or Print Head Nozzles on a FINE Cartridge. The machine may not print out properly if you touch it.
 - Do not reattach the protective tape once it has been removed.
 - Handle the removed protective tape carefully to avoid getting your hands dirty or staining surrounding work area.
-

4 Install the FINE Cartridge.

Important

- Make sure that the FINE Cartridge is installed in the correct position. The machine cannot be used unless the FINE Cartridge is installed.
- If the Cover is left open for more than 10 minutes, the Holder moves to the right side. Close and reopen the Cover to return the Holder to the left.
- Once you have installed the FINE Cartridge, <CART. RETURN> is displayed on the LCD. Wait until the standby screen is displayed before proceeding. It takes about one to two minutes.

Note

- The machine may make some operating noises when preparing to print. This is normal operation.
 - An error message will be displayed on the LCD if a FINE Cartridge is not installed properly. Open the Cover and make sure that position of the FINE Cartridge is appropriate.
-

Select the receive mode according to your needs. See "Different ways to receive a document" on page 32.

- Receiving both documents and telephone calls automatically:
<Fax/Tel Mode>/<NET SWITCH>*
- Receiving documents manually:
<MANUAL MODE>
- Receiving documents with an answering machine:
<ANS.MACHINE MODE>
- Receiving documents automatically and disconnects telephone calls:
<FAX ONLY MODE>

* This setting may not be available depending on the country or region of purchase.

Note

To use a fax, you need to set the telephone line type setting properly on the machine. For details on how to confirm and change this setting, see "Setting the Telephone Line Type" on page 14. If you are unsure of your telephone line type, contact your telephone company.

■ Selecting the Language for the LCD

If an unintended language is displayed on the LCD, change it into your desired language following the procedure below.

1 Press [Menu].

2 Press [▼] once, then press [Start/Copy].

3 Press [▼] five times, then press [Start/Copy].

4 Press [▼] twice, then press [Start/Copy].

The currently selected language name is displayed in the language itself.

5 Press [▼] once, then press [Start/Copy].

Each time you press [▼], the display cycles through:

<ENGLISH>, <GERMAN>, <FRENCH>, <ITALIAN>, <SPANISH>, <DUTCH>, <PORTUGUESE>, <NORWEGIAN>, <SWEDISH>, <DANISH>, <FINNISH>, <RUSSIAN>, <CZECH>, <HUNGARIAN>, <POLISH>, <SLOVENE>, and <CHINESE>.

6 If your desired language is displayed, press [Stop/Reset].

Setting ends and the fax returns to standby mode.

If your desired language is not displayed, press [▲] once, press [Start/Copy], then repeat from step 5 again.

Installing the Printer Driver

Important

The machine is not compatible with Macintosh computers.

Notes on the Installation Process

- Quit all running applications before installation.
- Log into a user account with the administrator privilege.
- Do not switch users during the installation process.
- If the **Found New Hardware** or **Found New Hardware Wizard** screen appears automatically, remove the USB cable connected to your computer. (In Windows XP and Windows 2000, remove the USB cable connected to your computer and click **Cancel** to quit the screen.) Then turn off the machine and start the installation process again. For details on the installation process, refer to your setup sheet.
- If installation does not start automatically when the *Setup CD-ROM* is inserted into your computer's disc drive, click **Start** then **Computer**. (In Windows XP, click **Start** then **My Computer**. In Windows 2000, double-click the **My Computer** icon on the desktop.) And double-click the CD-ROM icon on the displayed window. If the contents of the CD-ROM are displayed, double-click **MSETUP4.EXE**.
- If the **AutoPlay** screen appears, click **Run Msetup4.exe**. In Windows XP and Windows 2000, this screen will not appear.
- If the **User Account Control** screen appears, click **Continue**. In Windows XP and Windows 2000, this screen will not appear.
- If the **Select Language** screen appears, select a language, then click **Next**.
- If the **Select Your Place of Residence** screen appears, select your place of residence, then click **Next**.
- There are two ways of installing the printer driver and *On-screen Manual*:
 - Easy Install**: the items included on the *Setup CD-ROM* are installed automatically
 - Custom Install**: you can select particular items to install
- A message asking for your confirmation to restart your computer may appear during the installation process. If this message is displayed, follow the on-screen instructions and click **OK**. The installation resumes from where it left off when your computer has been restarted. While restarting, do not remove the *Setup CD-ROM*.
- If the connection is not recognized, refer to "Cannot Install the Printer Driver" on page 79.
- We would appreciate it if you would take part in the **Extended Survey Program** regarding the use of Canon printers. If **Do not agree** is clicked, the **Extended Survey Program** will not be installed but you can use the machine normally.
- Remove the *Setup CD-ROM* after installation is completed, then keep it in a safe place in case you need to reinstall the printer driver.

Notes on the Print Head Alignment

- If the straight line is misaligned or print quality is not satisfactory after installing the printer driver, you may need to align the Print Head. Refer to "Aligning the FINE Cartridge" on page 67.

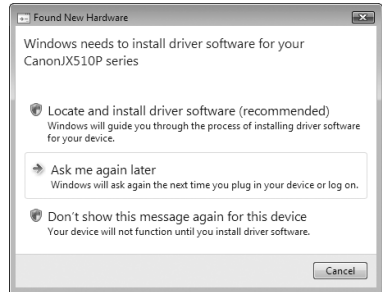

Before Using Your Machine

Main Components and Their Functions

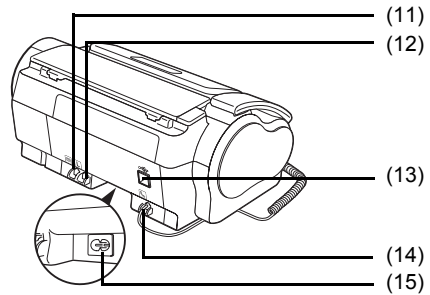
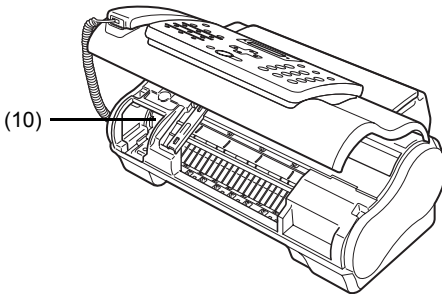
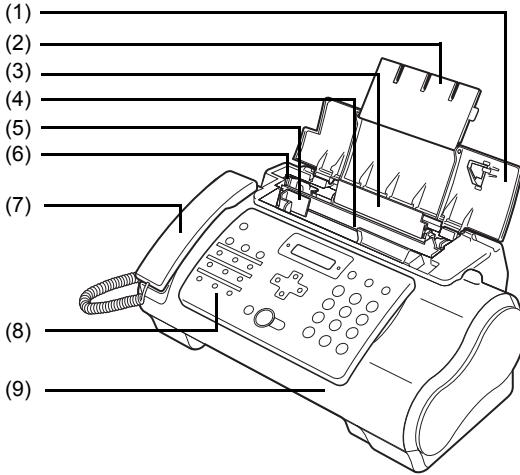

- (1) Document Cover
- (2) Paper Support
- (3) Rear Tray
- (4) ADF
- (5) Document Guide
- (6) Paper Guide
- (7) Handset
- (8) Operation Panel
- (9) Cover
- (10) Holder

- (11) External Device Jack
- (12) Telephone Line Jack
- (13) USB Port
- (14) Handset Jack
- (15) Power Cord Connector

■ Operation Panel

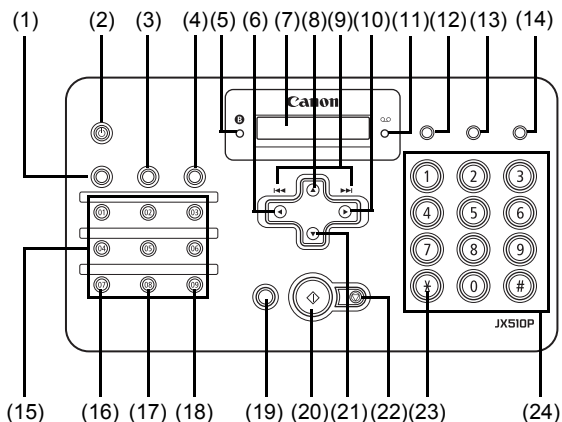

- | | |
|---|---|
| (1) [Maintenance] (see page 62) | (15) One-Touch Speed Dialing button (see page 17) |
| (2) [ON] (see page 12) | (16) [Pause] (see page 27) |
| (3) [Receive Mode/Resolution] (see page 22, page 24, page 33) | (17) [Space] (see page 13) |
| (4) [Menu] (see page 14) | (18) [Clear] (see page 14) |
| (5) Ink Lamp (see page 62) | (19) [Hook] (see page 23) |
| (6) [Caller History] (see page 27) | (20) [Start/Copy] |
| (7) LCD (Liquid Crystal Display) | (21) [Directory] (see page 26) |
| (8) [Coded] (see page 18) | (22) [Stop/Reset] |
| (9) [◀▶] (see page 46) | (23) Tone (see page 13, page 27) |
| (10) [Redial] (see page 27) | (24) Numeric buttons (see page 13) |
| (11) TAM Lamp (see page 43) | |
| (12) [TAM] (see page 43) | |
| (13) [Delete] (see page 46) | |
| (14) [Play] (see page 46) | |
- (JX510P only)

Turning the Machine ON and OFF

Turn on the machine before using.

■ Turning on the Machine

Before turning on the machine, confirm that the FINE Cartridge is set into place.

Note

If preparatory operations are not yet finished, follow your setup sheet to complete them.

- 1 To turn on the machine, press [ON].
[ON] flashes green for a while, and then turns on.

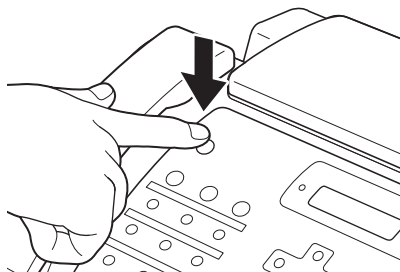

Note

- If an error message is displayed on the LCD, see “LCD Messages” on page 85.
- When the machine is left inactive for more than 4 minutes 30 seconds, the LCD goes off automatically and the machine enters the power saver mode. Press any button on the Operation Panel except for [ON] to restore the display.

■ Turning off the Machine

- 1 To turn off the machine, press [ON].
The machine is off after <SHUTTING DOWN...> is displayed on the LCD.

Important

- Always turn off the machine before disconnecting the power cord. This ensures the FINE Cartridge is covered to prevent it from drying out.
- If the machine is not used for an extended period of time, we recommend making copies or performing FINE Cartridge cleaning about once every month to prevent degradation of the FINE Cartridge.
- The FINE Cartridge has many nozzles in order to produce high-definition prints. In the same way that the tip of a felt-tip or marker pen will naturally dry out over time and become unusable even with the cap in place, the nozzles might become clogged. Periodically printing or performing FINE Cartridge cleaning can help to prevent this kind of clogging.
- If you change to another telephone line, turn off the machine before unplugging the telephone line cable.

Note

The power cannot be turned off with [ON] while the machine is operating.

Guidelines for Entering Numbers, Letters, and Symbols

When you come to a step that requires you to enter a name or number, see the table below to determine which numeric button to press for the letter you want.

Button	Uppercase Letter Mode (:A)	Lowercase Letter Mode (:a)	Number Mode (:1)
1			1
<small>ABC</small> 2	ABCĂĂĂĂĂĂĂÆÇ	abcăăăăăăăæç	2
<small>DEF</small> 3	DEFĎĎĎĎĎĎ	defďďďďďďď	3
<small>GHI</small> 4	GHIİİİİ	ghiıııı	4
<small>JKL</small> 5	JKL	jkl	5
<small>MNO</small> 6	MNOÑŃŎŎŎŎŎŎ	mnoññŋŏŏŏŏŏŏ	6
<small>PQRS</small> 7	PQRSÞ	pqrsþ	7
<small>TUV</small> 8	TUVÜÜÜÜÜ	tuvüüüüü	8
<small>WXYZ</small> 9	WXYZÝ	wxyzý	9
0			0
#	- . * # ! " , ; : ^ ` _ = / ' ? \$ @ % & + () [] { } < >		
*	Uppercase letter mode (:A) → Lowercase letter mode (:a) → Number mode (:1)		

Note

After 120 seconds of no operation panel input, the fax returns to standby mode and any unregistered changes are lost.

● Entering Numbers, Letters, and Symbols

- 1 Press [*****] to switch between the letter and number mode.

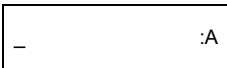

- 2 Use the numeric buttons to enter characters.

- Press repeatedly until the character you want appears.



- To enter a character that is under the same button as the previous entry:
 - (1) Press [**▶**], then press the same numeric button.
- To enter a space:
 - (1) Press [**▶**] or press [Space].

- To delete a character:
 - (1) Use [◀] or [▶] to move the cursor under the incorrect letter. Then press [Space].
- To delete an entire entry:
 - (1) Press [Clear].

- 3 Continue entering other letters or numbers using the numeric buttons.
- 4 When you have finished entering characters, press [Start/Copy] to register the entry.

Setting the Telephone Line Type

Before using your fax, make sure it is set for the telephone line type of your telephone system. If you are unsure of your telephone line type, check with your local telephone company.

Note

This setting is only available for some countries.

- 1 Press [Menu].
- 2 Use [▲] or [▼] to select <DATA REGISTRATION>, then press [Start/Copy] twice. The LCD displays <DATE & TIME>.
- 3 Use [▲] or [▼] to select <TEL LINE TYPE>, then press [Start/Copy]. The LCD displays <TOUCH TONE>.
- 4 Use [▲] or [▼] to select the telephone line type, then press [Start/Copy]. You can select <TOUCH TONE> or <ROTARY PULSE>.
- 5 Press [Stop/Reset].
Setting ends and the fax returns to standby mode.

Registering Sender Information

You can register sender information (Transmit Terminal Identification (TTI)) in your machine so that your name, your fax/telephone number, and the date and time of transmission are printed in small type at the top of each page to be received. Thus, whenever you send a fax from this machine, the recipient receiving the fax knows who sent it, and when it was sent.

Below is an example of how your sender information would print on a fax sent from your machine:

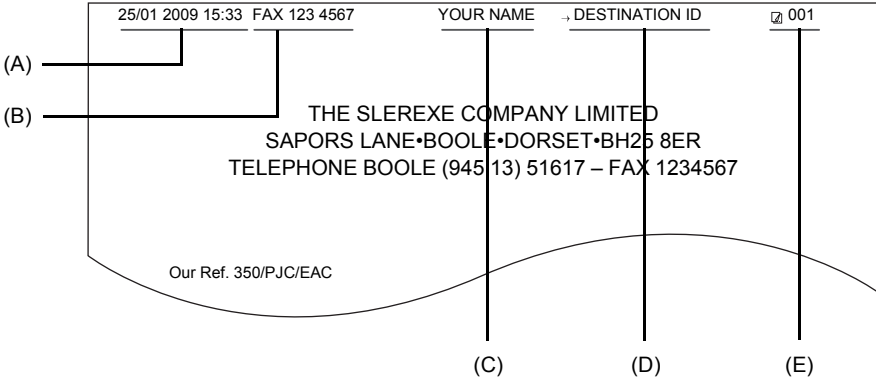

(A) Date and time of transmission

(B) Your fax/telephone number

You can select <FAX> or <TEL> to be displayed in front of the number. See <FAX/TEL No. MARK> on page 56.

(C) Your name

(D) Displays the name of the destination when sending from one-touch or coded speed dialing.

(E) Page number

■ Entering the Date and Time

1 Press [Menu].

2 Use [▲] or [▼] to select <DATA REGISTRATION>, then press [Start/Copy] three times.

25/01 2009 13:30

3 Use the numeric buttons to enter the date and time (in 24-hour format), then press [Start/Copy].

- Precede single digits with a zero.
- Enter only the last two digits of the year.

4 Press [Stop/Reset].

Registration ends and the fax returns to standby mode.

■ Registering Your Fax/Telephone Number and Name

This information appears at the top of each document you send.

- 1 Press [Menu].
- 2 Use [▲] or [▼] to scroll through the menus and select <DATA REGISTRATION>, then press [Start/Copy] twice. The LCD displays <DATE & TIME>.
- 3 Use [▲] or [▼] to select <UNIT TELEPHONE #>, then press [Start/Copy].
- 4 Enter your fax number (up to 20 digits) using the numeric buttons, then press [Start/Copy] twice (see page 13).

You can enter a space to make your number easier to read.

TEL=	123 xxxx
------	----------

- 5 Enter your name (up to 24 letters) using the numeric buttons, then press [Start/Copy] (see page 13).

CANON	:A
-------	----

- 6 Press [Stop/Reset].
Registration ends and the fax returns to standby mode.

■ Setting Daylight Saving Time (Summer Time)

Some countries adopt the daylight saving time (summer time) system that shifts the clock time forward or back at certain periods of the year.

You can set your machine to automatically change the time by registering the day and time that daylight saving time (summer time) begins and ends.

Note

Date and time displayed on the LCD may differ depending on the country/region of use.

- 1 Press [Menu].
- 2 Use [▲] or [▼] to select <DATA REGISTRATION>, then press [Start/Copy].
- 3 Use [▲] or [▼] to select <SYSTEM SETTINGS>, then press [Start/Copy].
- 4 Use [▲] or [▼] to select <DAYLIGHT SAV TIME>, then press [Start/Copy]. The LCD displays <ON>.
- 5 Use [▲] or [▼] to select <ON> or <OFF>, then press [Start/Copy].
- 6 If you cancel by selecting <OFF> in step 5, press [Stop/Reset] to return to standby mode.
If you select <ON> in step 5, use [▲] or [▼] to select <START DATE/TIME>, then press [Start/Copy] twice. The LCD displays <MARCH>.

- 7 Use [▲] or [▼] to select the month in which the summer time starts, then press [Start/Copy] twice. The LCD displays <LAST WEEK>.
- 8 Use [▲] or [▼] to select the week in which the summer time starts, then press [Start/Copy] twice. The LCD displays <SUNDAY>.
- 9 Use [▲] or [▼] to select the day in which the summer time starts, then press [Start/Copy] twice.

TIME	02:00
------	-------

- 10 Use the numeric buttons to enter the time at which the summer time will take effect, then press [Start/Copy]. The LCD displays <END DATE/TIME>.
- 11 Use [▲] or [▼] to select <END DATE/TIME>, then press [Start/Copy] twice. The LCD displays <OCTOBER>.
- 12 Repeat steps 7 to 9 to set the month, week, the day of the week, and time when the summer time ends.
- 13 Press [Stop/Reset].
Setting ends and the fax returns to standby mode.

Registering One-touch Speed Dialing Numbers and Names

One-touch speed dialing allows you to dial a number by pressing a single button. Before you can use one-touch speed dialing, you must register the receiving number with your fax.

You can also register the name of the party; the name appears on the printout of the ONE-TOUCH SPEED DIAL TELEPHONE NO. LIST.

Note

It is recommended to print out a copy of the ONE-TOUCH SPEED DIAL TELEPHONE NO. LIST and keep it for reference.

See "Activity Reports" on page 60 for details on printing the list.

- 1 Press [Menu].
- 2 Use [▲] or [▼] to select <TEL REGISTRATION>, then press [Start/Copy]. The LCD displays <1-TOUCH SPD DIAL>.
- 3 Press [Start/Copy]. The LCD displays <01=>.
- 4 Use [▲] or [▼] to select the number of the one-touch speed dialing button (01-09) under which you want to register the number, then press [Start/Copy] twice.
If a number is already registered under this one-touch speed dialing button, the number is displayed on the LCD.

- 5** Enter the party's number (up to 60 digits*) using the numeric buttons, then press [Start/Copy] twice.

TEL=250xxx_

* The values may differ depending on the country/region of use.

- 6** Enter the party's name (up to 16 letters) using the numeric buttons, then press [Start/Copy] to register the name (see page 13).

CANON :A

Note

To delete the name and number registered under the one-touch speed dialing button, press [Clear] and [Start/Copy] after you perform steps 1 to 4.

- 7** To assign additional one-touch speed dialing numbers, repeat from step 4. To finish, press [Stop/Reset].

Registering Coded Speed Dialing Numbers and Names

Use coded speed dialing to dial a fax number at the press of three buttons. A fax/telephone number can be registered under each two-digit speed dialing code and you can register up to 100 locations (60 locations for the JX210P model). You can also register the name of the party the name appears on the printout of the CODED SPEED DIAL TELEPHONE NO. LIST.

Note

It is recommended to print out a copy of the CODED SPEED DIAL TELEPHONE NO. LIST and keep it for reference.

See "Activity Reports" on page 60 for details on printing the list.

- 1** Press [Menu].
- 2** Use [▲] or [▼] to select <TEL REGISTRATION>, then press [Start/Copy]. The LCD displays <1-TOUCH SPD DIAL>.
- 3** Use [▲] or [▼] to select <CODED SPEED DIAL>, then press [Start/Copy]. The LCD displays <*00=>.
- 4** Use [▲] or [▼] to select the two-digit code (00-99)* under which you want to register the number, then press [Start/Copy] twice.

If a number is already registered under this coded speed dialing code, the number is displayed on the LCD.

*Select or enter the two-digit code (00-59) for the JX210P model.

- 5** Enter the party's number and name the same way you registered them for one-touch speed dialing.

See steps 5 to 6, "Registering One-touch Speed Dialing Numbers and Names" on page 17.

TEL=250xxx_

- 6** To assign additional coded speed dialing numbers, repeat from step 4. To finish, press [Stop/Reset].

 **Note**

To delete the name and number registered under the coded speed dialing code, press [Clear] and [Start/Copy] after you perform steps 1 to 4.

Document Requirements

■ Types of Document You Can Scan

● **Scanned Area**

The actual area scanned by the fax is shown below.

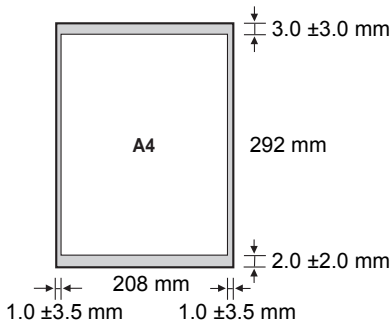

● **Size**

You can load documents larger than 105 mm wide and 105 mm long.

The maximum size of document that can be loaded is 216 mm wide by 400 mm long.

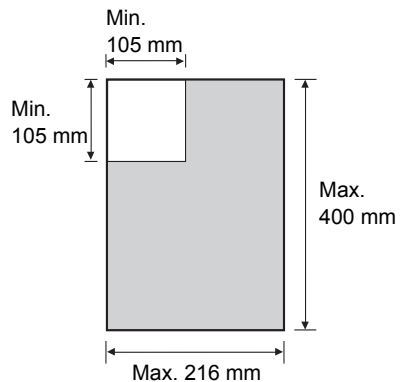

■ Problem Documents

- To prevent document jams in the ADF, do not attempt to load the following types of documents into the fax:
 - Wrinkled or creased paper
 - Torn paper
 - Coated paper or glossy paper
 - Thick paper
 - Curled or rolled paper
 - Carbon paper or carbon-backed paper
 - Onion skin or thin paper
 - Envelopes
- Remove all staples, paper clips, etc. before loading the document into the ADF.
- Make sure any glue, ink, or correction fluid on the paper is completely dry before loading the document into the ADF.
- Make a photocopy of any document that will not feed into the fax so that you can then load the copy into the ADF.

Paper Requirements

Your fax supports A4-, letter-, and legal-size paper in portrait orientation. You can use regular copier paper, cotton bond paper, or typical letterhead. Your fax does not require special ink jet paper. Always use paper without curls, folds, staples, or damaged edges. Look at the label on the package to see if the paper has a preferred side for printing.

Note

Be sure to test paper before purchasing large quantities.

■ Printable Area

The shaded area below shows the printable area of A4-size paper. Be sure to print within this area.

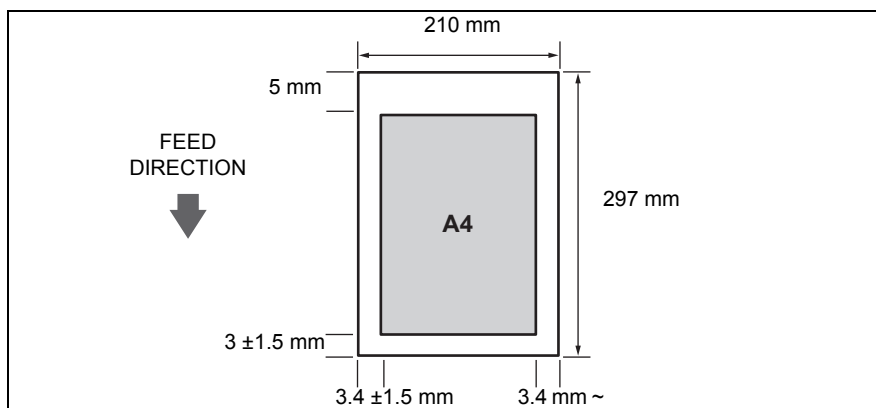

Loading Documents and Paper

- 1** Open the Document Cover (1) and extend the Paper Support (2) to support the paper.

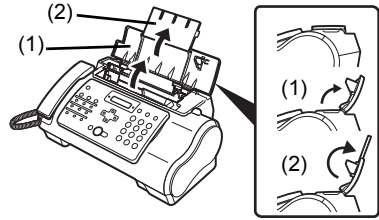

- 2** Squeeze, then slide the Paper Guide to the left.

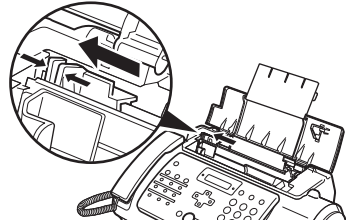

- 3** Insert the stack face up into the Rear Tray (1), and align the right edge of the stack with the right side of the Rear Tray. Then slide the Paper Guide (2) snugly against the left edge of the stack.

- Do not load higher than the paper limit mark (▶).
- Be careful not to press the Paper Guide strongly against the stack, or the paper will not be fed properly.

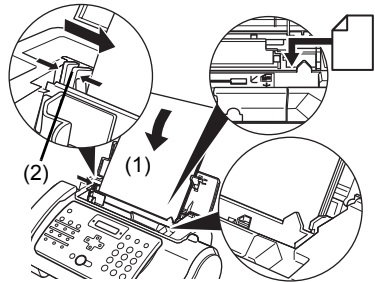

- 4** Gently insert the top of the document face up into the ADF until you hear a beep, adjust the Document Guide to the width of the document.

- To avoid feeding problems, make sure the document meets the document requirements (see page 19).

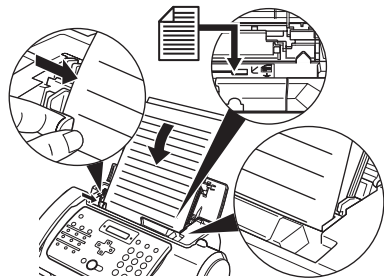

Note

- For a multipage document, the pages are fed one by one from the top of the stack.
- Wait until all pages of your document have been scanned before starting a new job.
- Make sure you follow the procedure to load documents into the ADF. If the document is not loaded into the ADF correctly, it may not be fed into the fax properly; resulting in a jam, or in pages not being sent.
- If you want to send a document with more than 20 (10 legal-size) pages, divide the document into sections and send each section in a separate transmission.
- For multipage documents, tap the stack on a flat surface to even the edges before loading.

Copying

Making Copies

One of the convenient features of the fax is its ability to make high quality copies. You can make up to 99 copies of one document at a time.

If you make copies of multiple documents at a time, the number of pages the fax can scan into memory is as follows:

- <COPY STANDARD>/<COPY FINE>/<COPY DRAFT> = 10 pages
-

Note

- The number of pages the fax can scan into memory is not affected by the scanning resolutions (see page 24).
 - <COPY STANDARD> and <COPY FINE> result in the same resolution when making copies.
 - If <MEMORY FULL> appears on the LCD when making multiple copies, see “Copying Problems” on page 77.
 - If paper jams, see “Troubleshooting” on page 72.
-

- 1** Load the document face up into the ADF.
See “Loading Documents and Paper” on page 21.
- 2** Press [Start/Copy]. The LCD displays <COPY PAGE 01>.
- 3** Press [Receive Mode/Resolution].
You can select <COPY STANDARD>, <COPY FINE>, or <COPY DRAFT>.
- 4** Enter the number of copies (up to 99) using the numeric buttons, then press [Start/Copy].
To make a correction to the number of copies, press [Clear] and re-enter the number.
To stop copying anytime, press [Stop/Reset]. If the document does not eject, press [Start/Copy] for a few seconds, then the fax will feed out the document. See “Jams in the ADF” on page 72.

Sending Faxes

Sending Documents

Before you send a document, see “Document Requirements” on page 19, and “Loading Documents and Paper” on page 21.

Note

- If paper jams, see “Troubleshooting” on page 72.
- You can send up to 20 A4-size (10 legal-size) pages at a time (based on the Canon FAX Standard Chart No.1, standard resolution). You cannot add pages while the fax is sending.
- The fax stores the document temporarily in memory when sending a document, however, when memory is full, it will send the document as it scans the document without storing document in memory.

■ Direct Sending

- 1 Load the document face up into the ADF.
See “Loading Documents and Paper” on page 21.
You can set the scanning resolution and contrast (see page 24).
- 2 Dial the receiving party’s fax number.
Use one of the dialing methods described in this chapter.

TEL=	3456xxxx
------	----------

- 3 Press [Start/Copy].
The fax begins sending.

Note

- If an error occurs during sending, the fax beeps intermittently for a few seconds and an error message appears on the LCD. If this happens, correct the problem and then press [Stop/Reset], then try sending the document again. See “LCD Messages” on page 85.
- The fax automatically redials if the receiving party does not answer or if the line is busy. (You can specify the number of times it redials; see <AUTO REDIAL> on page 57.)

■ Manual Sending

If you would like to first speak with the person you are sending the document to, use manual sending.

- 1 Load the document face up into the ADF.
See “Loading Documents and Paper” on page 21.
You can set the scanning resolution and contrast (see page 24).
- 2 Pick up the Handset or press [Hook] and dial the receiving party’s fax number.
Use one of the dialing methods described in this chapter.

TEL=	3456xxxx
------	----------

- 3** If a person answers, converse normally, then ask them to press the start button on their fax. Press [Start/Copy] and hang up.
If you hear a high pitch tone, press [Start/Copy] and hang up.
-

 **Note**

- If you pressed [Hook] in step 2, you need to pick up the Handset when a person answers the phone.
 - The fax will beep if the Handset is not hang up properly. Make sure the Handset is seated properly in its cradle. If you do not want the fax to beep, disable the <OFFHOOK ALARM> setting (see page 56).
 - If an error occurs during sending, the fax beeps intermittently for a few seconds and an error message appears on the LCD. If this happens, correct the problem then try sending the document again. See "LCD Messages" on page 85.
-

■ Canceling Sending

- 1** Press [Stop/Reset].
-

 **Note**

- When you cancel sending, you may need to press and hold [Start/Copy] for a few seconds to feed out the document.
 - You can set whether or not the fax prints the TX REPORT (see page 56).
-

■ Adjusting the Quality of Your Documents

● Setting the Scanning Resolution

Resolution is a measure of the fineness or clarity of a printout. Low resolutions may cause text and graphics to have a jagged appearance, while higher resolutions provide smoother curves and lines, crisp text and graphics, and a better match to traditional typeface designs.

 **Note**

Using a higher resolution will increase the output quality, but will slow down the scanning speed.

- 1** Load the document face up into the ADF.
See "Loading Documents and Paper" on page 21.
- 2** Press [Receive Mode/Resolution] to select the resolution.
You can select <FAX STANDARD>, <FAX FINE> or <FAX PHOTO>.
-

 **Note**

You cannot change the resolution setting while the machine is sending a fax or after it starts scanning.

● Setting the Scanning Contrast

Contrast is the difference in brightness between the lightest and darkest parts of a printed document. You can adjust the contrast your fax uses to send or copy documents, according to how light or dark your document is.

- 1** Press [Menu].
- 2** Use [▲] or [▼] to select <DATA REGISTRATION>, then press [Start/Copy] twice.
The LCD displays <DATE & TIME>.
-

- 3 Use [▲] or [▼] to select <SCAN CONTRAST>, then press [Start/Copy]. The LCD displays <STANDARD>.
- 4 Use [▲] or [▼] to adjust the scanning contrast, then press [Start/Copy].
You can select <STANDARD>, <DARKER> or <LIGHTER>.
- 5 Press [Stop/Reset].
Setting ends and the fax returns to standby mode.

Automatic Dialing

■ Sending a Document Using One-Touch Speed Dialing or Coded Speed Dialing Numbers

To use this feature you must first register numbers for one-touch speed dialing (see page 17) or coded speed dialing (see page 18).

- 1 Load the document face up into the ADF.
See "Loading Documents and Paper" on page 21.
You can set the scanning resolution and the contrast (see page 24).
- 2 Press the one-touch speed dialing button under which the number you wish to fax is registered.

01=CANON

-or-

Press [Coded] and enter the appropriate two-digit coded speed dialing code.

The registered name and number appear.

If you make a mistake, press [Stop/Reset]. Then press the correct one-touch speed dialing button or press [Coded] and re-enter the code.

*01=CANON

- 3 Press [Start/Copy].
The fax begins sending.
-or-
After about 10 seconds of no operation panel input, the fax starts sending automatically.

■ Sending a Document Using Directory Dialing

This feature is convenient when you know the other party's name but cannot recall the one-touch speed dialing button or the code for coded speed dialing where the number is registered.

This procedure can also be used to look up the other party's name and retrieve the number for dialing.

- 1** Load the document face up into the ADF.
See "Loading Documents and Paper" on page 21.
You can set the scanning resolution and the contrast (see page 24).
- 2** Press [Directory].
- 3** Press a numeric button to enter the first letter of the name of the party you are searching for.

*01=Canon CANADA

- 4** Press [▲] or [▼] to display the other names and numbers registered for the button letter group.
 - The names for one-touch speed dialing numbers are prefixed with two digits and the names for coded speed dialing numbers are prefixed with an asterisk (*) and two digits.
 - When you reach the last name and number registered for the letter group, you will return to the first name and number in the group.
 - If the LCD does not change after you press [▲] or [▼], this means only one name and number is registered for the button you just pressed.
 - Press [Redial] to switch between the name and number on the LCD.
- 5** With the telephone number you want to dial displayed, press [Start/Copy] to start the document transmission.

Special Dialing

■ Sending a Document Using Caller History

If the <CALLER ID> setting is set to <ON>, the caller's name and phone/fax number appear on the LCD when you receive a call (see page 60). The fax keeps up to 20 latest caller IDs in memory.

Note

The caller history feature is only available in some countries. The feature uses the Telcordia or the ETSI EN 300 778-1 protocol. Contact your local telephone company for detailed information.

1 Press [Caller History], then wait for 2 seconds or press any button.

The numbers, names, and date and time from which you have received calls recently will be displayed on the LCD.

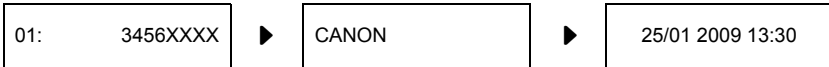

- Press [Redial] or [Caller History] to switch between the date and time, name, and phone/fax number on the LCD.

2 Use [▲] or [▼] to select the receiving party, then press [Start/Copy].

The fax begins calling the number.

■ Switching Temporarily to Tone Dialing

Many information services for banks, airline reservations, hotel reservations, etc. require tone dialing for their services. If your machine is connected to a rotary pulse line, you can set the machine to temporarily switch to tone dialing.

1 Press [Hook] or lift the Handset.

2 Use the numeric buttons to dial the number of the information service.

3 When the recorded message of the information service answers, press [Tone] ([*]) to switch to tone dialing.

If you pressed [Hook] in step 1 and wish to talk to the other party, lift the Handset.

4 Use the numeric buttons to enter the numbers requested by the information service.

5 When you have finished using the service, press [Hook] or hang up the Handset.

■ Long-Distance Dialing

When you register a long-distance number, you may have to insert a pause within or after the number. For long-distance dialing, the location and length of the pause may differ depending on the telephone system. To enter a pause, press [Pause]. The length of this pause can be adjusted. See <PAUSE TIME> on page 57. A pause at the end of a number is fixed at 10 seconds.

Redialing When the Line is Busy

There are two methods of redialing: manual redialing and automatic redialing. This section explains these two methods.

■ Manual Redialing

Press [Redial] to dial the last number you dialed with the numeric buttons*. (This starts redialing regardless of whether automatic redialing is enabled.)

*This setting is only available when you dialed with the numeric buttons.

● Canceling Manual Redialing

To cancel manual redialing, press [Stop/Reset]. You may then need to press [Start/Copy] for a few seconds to feed out the document. See "Jams in the ADF" on page 72.

■ Automatic Redialing

● What is Automatic Redialing?

When you are sending a document and the receiving party's line is busy, the fax waits the specified time and then dials the same number again. You can set the fax to redial several times if previous attempts fail because of a busy signal.

Automatic redialing can be turned off and on. The number of redialing attempts and the time interval between attempts can also be adjusted (see page 57).

If all redialing attempts are unsuccessful, the fax will cancel the transmission. You can set the fax to print the ERROR TX REPORT to remind you that the transmission was not completed (see page 56).

When automatic redialing is in use, the LCD displays <AUTO REDIAL> while it is waiting to redial.

● Canceling Automatic Redialing

- 1 Press [Stop/Reset].

Note

If you want to cancel a memory-sending transmission while the fax is waiting to redial, you will have to delete the document from memory (see page 41).

● Setting the Options for Automatic Redialing

You can set the following options for automatic redialing:

- Whether or not the fax redials automatically.
- The number of times the fax attempts to redial.
- The time interval between redialing attempts.

- 1 Press [Menu].

- 2 Use [▲] or [▼] to select <DATA REGISTRATION>, then press [Start/Copy]. The LCD displays <USER SETTINGS>.

- 3 Use [▲] or [▼] to select <TX SETTINGS>, then press [Start/Copy]. The LCD displays <ECM TX>.

- 4 Use [▲] or [▼] to select <AUTO REDIAL>, then press [Start/Copy]. The LCD displays <ON>.
 - To disable automatic redialing, use [▲] or [▼] to select <OFF>, then press [Start/Copy]. Press [Stop/Reset] to return to standby mode.
 - To enable automatic redialing, use [▲] or [▼] to select <ON> and continue with the steps below.
- 5 Press [Start/Copy] twice. The LCD displays <2TIMES>.
- 6 Use the numeric buttons, or [▲] or [▼] to enter the number of times you want the fax to redial, then press [Start/Copy] twice. The LCD displays <2MIN.>.
- 7 Use the numeric buttons, or [▲] or [▼] to enter the time interval between redialing attempts, then press [Start/Copy].
- 8 Press [Stop/Reset].
The fax returns to standby mode.

Delayed Sending

Your fax can send a document automatically at a preset time. This allows you to take advantage of lower late-night long-distance rates offered by some telephone companies.

The fax can only register one preset sending operation at a time.

- 1 Load the document face up into the ADF.
See "Loading Documents and Paper" on page 21.
You can set the scanning resolution and contrast (see page 24).
- 2 Press [Menu].
- 3 Use [▲] or [▼] to select <FAX OPTIONS>, then press [Start/Copy].
- 4 Use [▲] or [▼] to select <DELAYED TX>, then press [Start/Copy].

SET TIME	15:00
----------	-------

- 5 Enter the desired sending time (in 24-hour clock format) using the numeric buttons.
 - Precede single digits with a zero.
 - Press [Clear] if you need to re-enter the time.
 - You can also use [◀] or [▶] to move the cursor.
- 6 Press [Start/Copy].
- 7 Enter the receiving party's fax number.
 - You can enter the receiving party's fax number by using the numeric buttons, one-touch speed dialing, coded speed dialing, or directory dialing (see page 25).
 - If you use the numeric buttons, press [Start/Copy] after entering the number to register it.

- 8** Press [Start/Copy].
- Press [Start/Copy] when using directory dialing.
 - The fax scans the document into memory.

 **Note**

If <MEMORY FULL> appears on the LCD during scanning, delete unnecessary documents from the memory (see page 41), then rescan your fax.

- 9** The fax will automatically dial at the programmed time.

■ Sending Other Documents While the Fax is Set for Delayed Sending

You can send, receive, and copy other documents even when the fax is set for sending at a preset time.

To send or copy other documents after setting the fax for delayed sending, simply send or copy using any other sending procedure in this guide.

 **Note**

Delayed sequential broadcasting is applicable for sending one document to more than one location at a later time when multiple fax numbers are dialed (see page 31).

■ Canceling Delayed Sending

- 1** Press [Menu].
- 2** Use [▲] or [▼] to select <MEMORY REFERENCE>, then press [Start/Copy].
- 3** Use [▲] or [▼] to select <DELETE DOCUMENT>, then press [Start/Copy].

TX/RX NO.	0001
-----------	------

- 4** Use [▲] or [▼] to select the transaction number (<TX/RX NO.>) of the document you want to delete, then press [Start/Copy]. The LCD displays <YES=(*) NO=(#)>.
 - If the LCD does not change after you press [▲] or [▼], this means only one transaction is stored in memory.
 - If you are unsure of the transaction number (<TX/RX NO.>), print the MEMORY LIST (see page 40).
- 5** Press [*] to delete the document.
If you want to continue sending, press [#].
- 6** Press [Stop/Reset].
The fax returns to standby mode.

Sequential Broadcasting

■ Sending a Document to More Than One Location

Sequential broadcasting sends one document to more than one location.

You can send to a total of 110 locations (70 locations for the JX210P model) as follows:

- One-touch speed dialing = 9 locations
- Coded speed dialing = 100 locations (60 locations for the JX210P model)
- Regular dialing (Numeric buttons dialing) = 1 location

You can enter the one-touch speed dialing and coded speed dialing locations in any order. You simply press the one-touch speed dialing button, or press [Coded] or [Directory] followed by the two-digit code.

You can also include one location using regular dialing. Remember that when using regular dialing, you must press [Start/Copy] after entering the number.

Note

- You must press each button within 10 seconds of the preceding one. The fax begins the operation approximately 10 seconds after you press the last button.
 - The regular dialing number must be entered last.
-

1 Load the document face up into the ADF.

See “Loading Documents and Paper” on page 21.

You can set the scanning resolution and contrast (see page 24).

2 Dial the receiving party's fax numbers as you need.

You can also press [Redial] to redial the last number dialed with the numeric buttons.

TEL=	3456xxxx
------	----------

3 Press [Start/Copy].

- The fax reads the document into memory and begins sending.
- To cancel a transmission, press [Stop/Reset] during dialing or transmission. All transmissions in the sequence are canceled.

Receiving Faxes

Different ways to receive a document

Your fax provides you with several modes for receiving documents. To determine which mode best suits your requirements, see the table below.

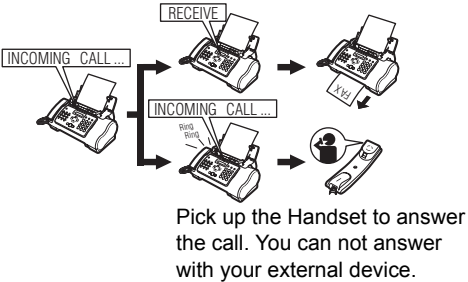
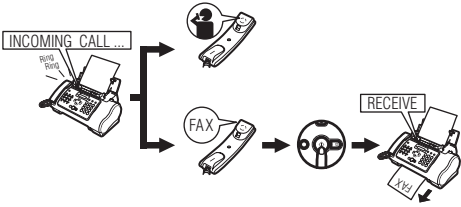
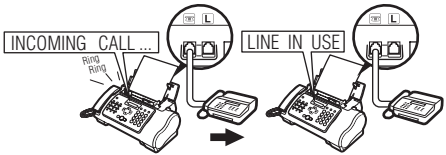
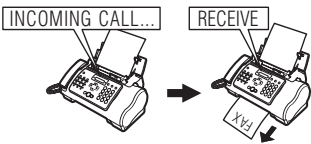
<Fax/Tel Mode>/<NET SWITCH>*	
 <p>Pick up the Handset to answer the call. You can not answer with your external device.</p>	<p>Automatically switches between fax and voice calls. Receives documents automatically and rings for voice calls (see page 33).</p> <p><NET SWITCH>: If your telephone service allows you to have one telephone line with two numbers: one for fax and one for telephone, use this mode. Subscribe to the Telstra FaxStream Duet service (Australia) or the Telecom FaxAbility service (New Zealand) (see page 35).</p>
<MANUAL MODE>	
	<p>Rings for every call, regardless of whether the call is a fax call or a voice call. For a fax call, you have to manually activate reception of the fax (see page 34).</p>
<ANS.MACHINE MODE>	
	<p>Receives documents automatically and routes voice calls to the answering machine. Connect an answering machine to your fax (see page 34). For the JX510P model, cancel TAM mode.</p>
<FAX ONLY MODE>	
	<p>Answers all calls as fax calls. Receives documents automatically and disconnects voice calls. Separate telephone line for fax use only. If you want to be alerted when a fax call is received, enable the <INCOMING RING> setting (see page 57).</p>

* This setting is only available for some countries.

Setting the Receive Mode

Once you have decided which mode is suitable for your needs, set the mode by pressing [Receive Mode/Resolution].

1 Press [Receive Mode/Resolution].

Every time you press [Receive Mode/Resolution], the mode changes cyclically.

■ Receiving Faxes: <FAX ONLY MODE>

Note

- If paper jams, see “Troubleshooting” on page 72.
- If the Ink Lamp lights up faxes will be received to memory.

■ Receiving Both Documents and Telephone Calls Automatically: <Fax/Tel Mode>

If you set <Fax/Tel Mode>, you can control precisely how the fax handles incoming calls by adjusting the following settings:

- Adjust the time the fax takes to check whether a call is from a fax machine or a telephone (<RING START TIME> setting).
- Adjust the length of time the fax rings when the call is a voice call (<TEL RING TIME> setting).
- Set whether the fax switches to receive mode after the ring time set in <TEL RING TIME> has elapsed (<DEFAULT ACTION> setting).

1 Press [Menu].

2 Use [▲] or [▼] to select <DATA REGISTRATION>, then press [Start/Copy]. The LCD displays <USER SETTINGS>.

3 Use [▲] or [▼] to select <RX SETTINGS>, then press [Start/Copy]. The LCD displays <ECM RX>.

4 Use [▲] or [▼] to select <FAX/TEL AUTO SW>, then press [Start/Copy]. The LCD displays <RING START TIME>.

5 Press [Start/Copy].

8SEC

6 Use the numeric buttons, or [▲] or [▼] to enter the time the fax waits before ringing when it receives a call, then press [Start/Copy] twice.

22SEC

7 Use the numeric buttons, or [▲] or [▼] to enter the time the fax rings while waiting for someone to pick up the Handset, then press [Start/Copy] twice. The LCD displays <RECEIVE>.

- 8** Use [▲] or [▼] to select <RECEIVE> or <DISCONNECT>, then press [Start/Copy].
This setting tells the fax what to do if the Handset is not picked up within the specified ring time set in step 6.
- 9** Press [Stop/Reset].
Setting ends and the fax returns to standby mode.

■ Receiving Documents Manually: <MANUAL MODE>

- 1** Check that <Manual> is displayed on the LCD (see page 33).

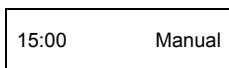

- 2** When you hear the fax or extension phone ring, pick up the Handset.
- 3** If you hear a person's voice:
Start your conversation. If the caller wants to send a document after talking to you, ask them to press the start button on their fax machine.
When you hear a slow beep, press [Start/Copy] on the fax to begin receiving the document. Hang up the Handset.
- If the extension phone is located away from the fax, dial 25 (the remote receiving ID) on the extension phone and hang up.
 - The fax begins receiving the document.

If you hear a slow beep tone:

Someone is trying to send you a document.

- Press [Start/Copy] and replace the Handset.
- If the extension phone is located away from your fax, dial 25 (the remote receiving ID) on the extension phone and hang up.
- The fax begins receiving the document.

Note

Be sure to replace the Handset after you press [Start/Copy] otherwise the call will be disconnected.

■ Receiving Documents with an Answering Machine: <ANS.MACHINE MODE>

Connecting an answering machine to your fax allows you to receive documents and telephone messages while you are out.

● Using Your Fax with an Answering Machine

Follow these guidelines when using your fax with an answering machine.

- Set the answering machine to answer on the first or second ring.
- When recording an outgoing message on the answering machine, the entire message must be no longer than 15 seconds.

Canceling Receiving

- 1 Press [Stop/Reset].

Telstra FaxStream Duet (Australia only)

Telstra offers the FaxStream Duet capability. If you subscribe to this service, your line is assigned two numbers: one for fax and one for phone. When the fax number is called, the network sends a specific ringing tone which your fax recognizes and automatically handles as a fax call. If the phone number is called, a different ringing tone is sent out from the network so that the call is handled as a voice call. This means that there is no switching delay at the other party's end.

Contact Telstra for connection information.

■ Setting the Fax for Network Switch

- When the fax number is called, you will hear a triple-ring* ringing tone.
- When the telephone number is called, you will hear a ringing tone other than the triple-ring ringing tone. The ringing tone depends on your switchboard.

- 1 Press [Receive Mode/Resolution] to select <NET SWITCH>.

See "Setting the Receive Mode" on page 33.



The fax returns to standby mode.

* Three short rings (short-short-short) at regular intervals.

■ Operation for Network Switch System

The procedures for using the network switch system are almost the same as when using the fax over a normal telephone line. When you receive calls, however, the fax will respond slightly differently as described below.

When you hear the telephone call ring pattern:

Pick up the Handset and talk normally. If you hear a slow beep, it means the call is from a fax machine trying to send a document. Press [Start/Copy] to receive the document. If you do not pick up the Handset, the fax continues to ring until the other party hangs up. If an answering machine is connected, it takes over the call.

When you hear the fax call ring pattern (triple ring):

After the fax rings, it receives the document automatically.

Telecom FaxAbility (New Zealand only)

Telecom N.Z. offers the FaxAbility capability. If you subscribe to this service, your line is assigned two numbers: one for fax and one for phone. When the fax number is called, the network sends a specific ringing tone which your fax recognizes and automatically handles as a fax call. If the phone number is called, a different ringing tone is sent out from the network so that the call is handled as a voice call. This means that there is no switching delay at the other party's end.

Contact Telecom for connection information.

■ Setting the Fax for Network Switch

- 1 Press [Receive Mode/Resolution] to select <NET SWITCH>.

See "Setting the Receive Mode" on page 33.



The fax returns to standby mode.

■ Operation for Network Switch System

The procedures for using the network switch system are almost the same as when using the fax over a normal telephone line. When you receive calls, however, the fax will respond slightly differently as described below.

When you hear the telephone call ring pattern:

Pick up the Handset and talk normally. If you hear a slow beep, it means the call is from a fax machine trying to send a document. Press [Start/Copy] to receive the document. If you do not pick up the Handset, the fax continues to ring until the other party hangs up. If an answering machine is connected, it takes over the call.

When you hear the fax call ring pattern (double ring):

After the fax rings, it receives the document automatically.

Other Features

■ Saving Ink

You can enable/disable ink-saving feature by selecting <INK SAVER> when [Menu] is pressed.

Note

By enabling this feature, print quality will be reduced. For highest print quality, disable this feature.

- 1 Press [Menu].
- 2 Use [▲] or [▼] to select <DATA REGISTRATION>, then press [Start/Copy].
- 3 Use [▲] or [▼] to select <PRINTER SETTINGS>, then press [Start/Copy].
- 4 Use [▲] or [▼] to select <INK SAVER>, then press [Start/Copy].
- 5 Use [▲] or [▼] to select <ON> or <OFF>, then press [Start/Copy].
- 6 Press [Stop/Reset].
Setting ends and the fax returns to standby mode.

■ Receiving to Memory Temporarily

You can enable/disable memory receiving feature temporarily by selecting <AUTO PRINT> when [Menu] is pressed.

- 1 Press [Menu].
- 2 Use [▲] or [▼] to select <DATA REGISTRATION>, then press [Start/Copy].
- 3 Use [▲] or [▼] to select <PRINTER SETTINGS>, then press [Start/Copy].
- 4 Use [▲] or [▼] to select <AUTO PRINT>, then press [Start/Copy].
- 5 Use [▲] or [▼] to select <ON> or <OFF>, then press [Start/Copy].
- 6 Press [Stop/Reset].

Setting ends and the fax returns to standby mode.

- If you select <ON> in step 5, received faxes will be printed automatically.
- If you select <OFF> in step 5, the fax starts receiving documents in memory. The LCD displays <AUTO PRINT OFF>.

Note

If the <AUTO PRINT> setting is set to <OFF>, the following will not be printed automatically: ACTIVITY REPORT, TX REPORT, RX REPORT, MULTI TX REPORT and MEMORY CLEAR REPORT.

■ Changing Calling Volume

- 1 Press [Menu].
- 2 Use [▲] or [▼] to select <DATA REGISTRATION>, then press [Start/Copy].
- 3 Use [▲] or [▼] to select <USER SETTINGS>, then press [Start/Copy].
- 4 Use [▲] or [▼] to select <VOLUME CONTROL>, then press [Start/Copy].
- 5 Use [▲] or [▼] to select <CALLING VOLUME>, then press [Start/Copy].
- 6 Use [▲] or [▼] to change the volume, then press [Start/Copy].
- 7 Press [Stop/Reset].

Setting ends and the fax returns to standby mode.

■ Receiving Documents in Memory While Performing Another Task or When a Problem Occurs

If your fax is performing another task or encounters a problem when receiving a document, it automatically stores the unprinted pages in memory, and the LCD displays <REC'D IN MEMORY> as well as one or more messages. For an explanation of the message(s) and details on the action to take, see page 88.

Note

Once the pages are printed, they are deleted from memory.

■ Polling to Receive Documents

The polling feature allows you to request a document to be faxed to you from another fax machine. The sending party only needs to make sure the document is on a fax machine and ready to be sent. Thus, when your fax polls the other fax machine, the document is sent automatically. The fax can poll any fax machine that supports polling.

Note

- Before attempting to poll a fax machine, make sure that the other fax machine supports polling.
 - Your fax cannot do polling transmissions.
-

- 1 Press [Menu].
- 2 Use [▲] or [▼] to select <FAX OPTIONS>, then press [Start/Copy].
- 3 Use [▲] or [▼] to select <POLLING RX>, then press [Start/Copy].
- 4 Dial the fax number of the fax machine you wish to poll.
Use one of the dialing methods described.

TEL=	3456xxxx
------	----------

- 5 Press [Start/Copy].
Your fax begins receiving the document.

Setting Caller ID

If the <CALLER ID> setting is set to <ON>, the caller's name and phone/fax number appear on the LCD when you receive a call. You can also set the fax to reject unwanted calls (JX510P only).

Note

- <CALLER ID> is only available in some countries.
 - To use this feature, you will need to subscribe for a caller ID service (only available in some countries). The <CALLER ID> feature uses the Telcordia or the ETSI EN 300 778-1 protocol. Contact your local telephone company for detailed information on this service.
 - If the <CALLER ID> setting is set to <ON>, the machine will not enter the power saver mode (see page 12).
-

- 1 Press [Menu].
- 2 Use [▲] or [▼] to select <DATA REGISTRATION>, then press [Start/Copy].
- 3 Use [▲] or [▼] to select <CALLER ID>, then press [Start/Copy]. The LCD displays <OFF>.
- 4 Use [▲] or [▼] to select <ON> to enable the <CALLER ID> feature, then press [Start/Copy].
To disable the <CALLER ID> feature, use [▲] or [▼] to select <OFF>, then press [Start/Copy]. Press [Stop/Reset] to return to standby mode.
- 5 Press [Start/Copy].

- 6** Use [▲] or [▼] to select the type of <CALL REJECTION> setting (JX510P only) you want, then press [Start/Copy].
- You can select from the followings:
- <ANONYMOUS>: The fax rejects calls from any callers who have blocked their phone/fax number from the caller ID service.
 - <SELECTIVE>: The fax rejects calls from specific phone/fax numbers you place in <REJECTED NUMBER> list.
 - <OUT OF AREA>: The fax rejects calls from any callers in an area that does not have the caller ID service.
 - <SHOW IN HISTORY?>: Determine if the fax stores phone/fax number for rejected calls in memory.
- 7** Use [▲] or [▼] to select <ON> (YES), then press [Start/Copy].
- If you set to <OFF>, the setting goes on to the next <CALL REJECTION> setting.
 - If you set <ANONYMOUS> or <OUT OF AREA> to <ON>, select a method to reject calls in <REJECTION METHOD>. Press [Start/Copy], then proceed to step 12.
 - If you set <SELECTIVE> to <ON>, register the specific phone/fax numbers you want to reject in <REJECTED NUMBER> list. Follow the steps below.
 - If you set <SHOW IN HISTORY?> to <YES> or <NO>, <TEL REGISTRATION> is displayed on the LCD.
If you want to finish the <CALLER ID> setting, press [Stop/Reset] to return to standby mode.
If you want to continue to set other <CALL REJECTION> settings, press [▲], and then repeat from step 2 again.
- 8** Press [Start/Copy].
- 9** Use [▲] or [▼] to select the number of <REJECTED NUMBER> list (00-09) under which you want to register the phone/fax number, then press [Start/Copy].
- 10** Enter the phone/fax number using the numeric buttons, then press [Start/Copy].
- 11** To assign additional numbers, repeat the procedure from step 9.
To finish, press [Menu], then select a method to reject calls in <REJECTION METHOD>. Press [Start/Copy].
- 12** Use [▲] or [▼] to select <PLAY MESSAGE> or <DISCONNECT>, then press [Start/Copy].
- <PLAY MESSAGE>: The call will be disconnected after <OUTGOING MESSAGE> (see page 42) is played. If you set <SELECTIVE> to <ON> in step 6, and want to select this setting, <OUTGOING MESSAGE> must have been recorded.
 - <DISCONNECT>: The call will be disconnected without notice.
- 13** Press [Stop/Reset] to return to standby mode.

Documents Stored in Memory

■ Printing the MEMORY LIST

Your fax can print a list of documents stored in memory, along with the transaction number (<TX/RX NO.>) of each document. Once you know the transaction number of a document in memory, you can print it or delete it.

- 1 Press [Menu].
- 2 Use [▲] or [▼] to select <MEMORY REFERENCE>, then press [Start/Copy].
- 3 Use [▲] or [▼] to select <DOC. MEMORY LIST>, then press [Start/Copy].

■ Printing a Document in Memory

- 1 Press [Menu].
- 2 Use [▲] or [▼] to select <MEMORY REFERENCE>, then press [Start/Copy].
- 3 Use [▲] or [▼] to select <PRINT DOCUMENT>, then press [Start/Copy].

TX/RX NO.	0001
-----------	------

- 4 Use [▲] or [▼] to select the transaction number (<TX/RX NO.>) of the document you want to print, then press [Start/Copy]. The LCD toggles between <1ST PAGE ONLY?> and <YES=(*) NO=(#)>.

If you are unsure of the transaction number (<TX/RX NO.>), print the MEMORY LIST (see page 40).

- 5 Press [*] to print the first page only, or press [#] to print all pages of the document. The fax prints the document.

■ Printing All Unprinted Documents in Memory

- 1 Press [Menu].
- 2 Use [▲] or [▼] to select <MEMORY REFERENCE>, then press [Start/Copy].
- 3 Use [▲] or [▼] to select <PRINT ALL NEW RX>.

- 4 Press [Start/Copy].

The fax prints the documents one at a time, after each the reception number is displayed on the LCD.

- 5 After printing, the LCD displays <YES=(*) NO=(#)>.

- 6 Press [*] to delete the previous printed documents. If you want to keep the documents in memory, press [#].

■ Deleting a Document from Memory

- 1 Press [Menu].
- 2 Use [▲] or [▼] to select <MEMORY REFERENCE>, then press [Start/Copy].
- 3 Use [▲] or [▼] to select <DELETE DOCUMENT>, then press [Start/Copy].

TX/RX NO.	0001
-----------	------

- 4 Use [▲] or [▼] to select the transaction number (<TX/RX NO.>) of the document you want to delete, then press [Start/Copy]. The LCD displays <YES=(*) NO=(#)>.
 - If the LCD does not change after you press [▲] or [▼], this means only one transaction is stored in memory.
 - If you are unsure of the transaction number (<TX/RX NO.>), print the MEMORY LIST (see page 40).
- 5 Press [*] to delete the document.
If you want to keep the document in memory, press [#].
- 6 To continue deleting other documents in memory, repeat the procedure from step 4. To finish, press [Stop/Reset].

■ Deleting All Printed Documents from Memory

- 1 Press [Menu].
- 2 Use [▲] or [▼] to select <MEMORY REFERENCE>, then press [Start/Copy].
- 3 Use [▲] or [▼] to select <DEL. PRINTED RX>, then press [Start/Copy]. The LCD displays <YES=(*) NO=(#)>.
- 4 Press [*] to delete all printed documents.
If you want to keep the documents in memory, press [#]. Press [Stop/Reset] to return to standby mode.

Using TAM Mode (JX510P only)

Recording the Outgoing Message

Before you use the built-in answering machine (TAM), you must record an outgoing message. Use the Handset on the fax to record your outgoing message. Only one outgoing message, no longer than 20 seconds, can be recorded.

Note

You cannot receive documents while you are recording a message or voice memo. Also, the <CALLER ID> feature (see page 38) may not work properly.

■ Types of Messages that can be Recorded

<OUTGOING MESSAGE>: Answering machine message, used when <PLAY MESSAGE> has been selected when the call is disconnected (see page 39). Caller cannot leave a message.

<ALT OUTGOING MSG>: Answering message only, used when the recording time is set to 0, or the memory is full.

<VOICE MEMO>: See page 45.

<FAXTEL MESSAGE>: Message played when <Fax/Tel Mode> is set. The fax receives documents automatically and only rings for voice calls.

<FORWARDING MSG>: Message played when any new telephone messages are forwarded to a forwarding number.

■ Recording the Outgoing Message

To record another type of message, select the type of message you want to record in step 3, and then follow the procedure below to record it.

- 1 Press [Menu].
- 2 Use [▲] or [▼] to select <MSG REGISTRATION>, then press [Start/Copy].
- 3 Use [▲] or [▼] to select <OUTGOING MESSAGE>, then press [Start/Copy].
You can record an alternative outgoing message, fax/tel message or forwarding message by selecting the appropriate message and then continuing on to steps 4 to 7.
- 4 Use [▲] or [▼] to select <RECORD>, then press [Start/Copy]. The LCD displays <LIFT HANDSET>.
- 5 Pick up the Handset. Press [Start/Copy] and speak into the Handset to record your outgoing message.
The remaining recording seconds is displayed on the LCD.
- 6 Press [Stop/Reset] when recording is finished. The LCD displays <REPLACE HANDSET>.

7 Hang up the Handset and press [Stop/Reset].

The fax returns to standby mode.

Note

You cannot delete <OUTGOING MESSAGE> or <ALT OUTGOING MSG>. To record a new outgoing message or alternative outgoing message, repeat steps 1 to 7. An old outgoing message or alternative outgoing message will be deleted automatically when you record a new message.

Setting TAM Mode

Setting TAM mode allows you to receive telephone messages (ICM) and fax transmissions while the fax is unattended.

1 Press [TAM] to set TAM mode.

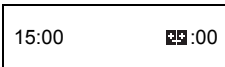

- When you set TAM mode, the TAM Lamp lights up and the outgoing message is played.
- To cancel TAM mode, press [TAM] again. This turns off the TAM Lamp. If you have any new telephone messages, the messages are played automatically.

Note

- <NO OGM> is displayed on the LCD when no outgoing message has been recorded. You must record an outgoing message before you can set TAM mode (see page 42).
- A maximum of 55 messages, including telephone messages, outgoing message, alternative message, voice memos, Fax/Tel message and forwarding message, with a total maximum recording time of 30 minutes can be recorded.
- You can set a maximum recording time of 240 seconds for telephone messages (see page 44).
- The number of messages or total recording time may be reduced if there are many faxes stored in memory.
- If you have any new telephone messages, the TAM Lamp blinks and the number of messages appears on the LCD.
- The day and time when the telephone message was recorded, the number of telephone messages and the number of the message being played (ICM No.) are displayed whenever a message is played (see page 46).
- When the fax is set to <MANUAL MODE> and <MAN/AUTO SWITCH> has been set to <OFF> (see page 57), TAM mode will be activated if the fax rings 15 times and the call is not answered (only when an outgoing message has been recorded). When the call is disconnected, the fax returns to <MANUAL MODE>.

■ Setting the Recording Time for a Telephone Message

- 1 Press [Menu].
- 2 Use [▲] or [▼] to select <DATA REGISTRATION>, then press [Start/Copy]. The LCD displays <USER SETTINGS>.
- 3 Use [▲] or [▼] to select <TAM SETTINGS>, then press [Start/Copy] twice. The LCD displays <60 SECONDS>.
- 4 Use [▲] or [▼] to select the recording time, then press [Start/Copy].
The recording time can be set to 0, 60, 120 or 240 seconds.
- 5 Press [Stop/Reset].
Setting ends and the fax returns to standby mode.

Note

When the recording time is set to 0, the alternative outgoing message is played. If an alternative outgoing message has not been recorded, the outgoing message is played. In this case, there will be no beep after the message is played and the caller will not be able to leave a message.

■ Setting <TAM MONITOR>

<TAM MONITOR> allows you to screen all incoming calls.

Note

To use this feature, <LINE MONITOR VOL> (see page 56) must be set to a setting other than 0. If <LINE MONITOR VOL> is set to 0, you will not be able to hear any incoming messages as they are being recorded.

- 1 Press [Menu].
- 2 Use [▲] or [▼] to select <DATA REGISTRATION>, then press [Start/Copy]. The LCD displays <USER SETTINGS>.
- 3 Use [▲] or [▼] to select <TAM SETTINGS>, then press [Start/Copy]. The LCD displays <MESSAGE LENGTH>.
- 4 Use [▲] or [▼] to select <TAM MONITOR>, then press [Start/Copy]. The LCD displays <ON>.
- 5 Use [▲] or [▼] to select <ON>, then press [Start/Copy].
- 6 Press [Stop/Reset].
Setting ends and the fax returns to standby mode.

■ Setting <TOLL SAVER>

Setting <TOLL SAVER> allows you to check whether you have any new messages when you call from a remote location. When <TOLL SAVER> is set to <ON> and there are new messages, the fax will answer after the second ring. If there are no new messages the fax will ring five times before answering.

- 1 Press [Menu].
- 2 Use [▲] or [▼] to select <DATA REGISTRATION>, then press [Start/Copy]. The LCD displays <USER SETTINGS>.
- 3 Use [▲] or [▼] to select <TAM SETTINGS>, then press [Start/Copy]. The LCD displays <MESSAGE LENGTH>.
- 4 Use [▲] or [▼] to select <TOLL SAVER>, then press [Start/Copy]. The LCD displays <ON>.
- 5 Use [▲] or [▼] to select <ON>, then press [Start/Copy].
- 6 Press [Stop/Reset].
Setting ends and the fax returns to standby mode.

Recording Voice Memos

Use this feature when you are going out and want to leave a message for another member of the family. Use the Handset on the fax to record your voice memo.

Only one voice memo, 60, 120, or 240 seconds*, can be recorded. If you record a new voice memo when there is already a voice memo recorded, the old voice memo will be deleted.

- 1 Press [Menu].
- 2 Use [▲] or [▼] to select <MSG REGISTRATION>, then press [Start/Copy].
- 3 Use [▲] or [▼] to select <VOICE MEMO>, then press [Start/Copy].
- 4 Use [▲] or [▼] to select <RECORD>, then press [Start/Copy]. The LCD displays <LIFT HANDSET>.
- 5 Pick up the Handset. Press [Start/Copy] and speak into the Handset to record your voice memo.
The remaining recording seconds is displayed on the LCD.
- 6 Press [Stop/Reset] when recording is finished. The LCD displays <REPLACE HANDSET>.

7 Hang up the Handset and press [Stop/Reset].

The fax returns to standby mode.

Note

To play a voice memo, carry out step 1 to 3, select <PLAY> and then press [Start/Copy].

* The recording time for a voice memo can be set to the same settings as the recording time for a telephone message. However, if you set 0 as the recording time for each telephone message, voice memo recording time will be set to 60.

Deleting Messages

- 1 Press [Menu].
- 2 Use [▲] or [▼] to select <MSG REGISTRATION>, then press [Start/Copy].
- 3 Use [▲] or [▼] to select the type of message you want to delete, then press [Start/Copy]. The LCD displays <PLAY>.
- 4 Use [▲] or [▼] to select <DELETE>, then press [Start/Copy].
- 5 Press [Stop/Reset].
The fax returns to standby mode.

Note

You cannot delete <OUTGOING MESSAGE> or <ALT OUTGOING MSG>. An old outgoing message or alternative outgoing message will be deleted automatically when you record a new message.

Playing Telephone Messages

Telephone messages will be played back in order from the oldest message recorded. If a voice memo has been recorded, it will be played back first.

- 1 Press [Play].

The day and time when the telephone message was recorded, the number of telephone messages and the number of the message being played (ICM No.) are displayed whenever a message is played.

SUN 17:15	02/05
-----------	-------

Note

- Press [◀◀] to listen to the message again. (Repeat)
- Press [▶▶] to play the next message. (Skip)
- Press [◀◀] twice to play the previous message.
- Press [Stop/Reset] to stop playback.
- Press [Delete] during playback to delete a message.
- Use [▲] or [▼] to change the volume.

Follow the procedures below to delete all messages.

- 1 Press [Delete]. The LCD displays <YES=(*) NO=(#)>.
- 2 Press [*] to delete all messages.
 - A voice memo is not deleted (see page 46).
 - If you decide not to delete all messages, press [#].

Remote Control Features

Use these features when you call home to play back any messages you may have received. You can also use the remote control features to set TAM mode.

You must register a four-digit PIN as your password before you can use these features.

■ Registering the Password for Remote Control

- 1 Press [Menu].
- 2 Use [▲] or [▼] to select <DATA REGISTRATION>, then press [Start/Copy]. The LCD displays <USER SETTINGS>.
- 3 Use [▲] or [▼] to select <TAM SETTINGS>, then press [Start/Copy]. The LCD displays <MESSAGE LENGTH>.
- 4 Use [▲] or [▼] to select <PASSWORD>, then press [Start/Copy]. The LCD displays <PASSWORD XXXX>*.
*The default setting is 1234.
- 5 Use the numeric buttons to enter a four-digit PIN as your password, then press [Start/Copy].
- 6 Press [Stop/Reset].
Registration ends and the fax returns to standby mode.

■ Using Remote Control

- 1 Call home.
- 2 The outgoing message will be played.
- 3 Press [#] while the outgoing message is playing. Enter your password when you hear the beeps indicating that you should enter your password. When your password is accepted, you will hear a confirmation tone (a short series of beeps).
- 4 The fax will now accept remote control commands (see “List of Remote Control Commands” on page 49).
For example, press [1][1][#] to play back any telephone messages you may have received. When playback has finished, press [9][9][#] to end the remote control.
- 5 End the remote control and hang up the Handset.

Note

- A password is required to use the remote control features. However, if <PIN ENTRY> is set to <OFF> (see page 59), it is not necessary to enter your password when you use the <FORWARDING MSG> feature (see page 50).
 - If you enter an invalid password, you will hear an error tone. If you enter two invalid passwords consecutively, the call will be disconnected.
 - You should enter a remote command within 20 seconds of entering your password. If more than 20 seconds elapse after you enter your password and you do not enter a remote command, the call will be disconnected.
 - The remote control features can be used even when the fax is set to a mode other than TAM mode.
 - In <FAX ONLY MODE>, the outgoing message will not be played. Press [#] when the call is connected.
 - In <Fax/Tel Mode>, press [#] while the Fax/Tel message is playing. If you have not recorded a Fax/Tel message, press [#] when the call is connected.
 - When the fax is set to <MANUAL MODE> and <MAN/AUTO SWITCH> has been set to <OFF> (see page 57), TAM mode will be activated if the fax rings 15 times and the call is not answered (only when an outgoing message has been recorded). When the call is disconnected, the fax returns to <MANUAL MODE>. Press [#] while the outgoing message is playing. Then, enter your password when you hear the beeps.
-

● List of Remote Control Commands

Command	Sub-command*	Description
11#		Play ICM
	4#	Repeat
	6#	Skip
	5#	Stop playback
	9#	Delete
19#		Delete all ICM
20#		Record voice memo
	#	End recording
21#		Play voice memo
	4#	Repeat
	5#	Stop playback
29#		Delete voice memo
31#		Record outgoing message
	#	End recording
32#		Record alternative outgoing message
	#	End recording
33#		Record forwarding message
	#	End recording
34#		Record FAX/TEL message
	#	End recording
41#		Play outgoing message
	4#	Repeat
	5#	Stop playback
42#		Play alternative outgoing message
	4#	Repeat
	5#	Stop playback
43#		Play forwarding message
	4#	Repeat
	5#	Stop playback
44#		Play FAX/TEL message
	4#	Repeat
	5#	Stop playback
50#		Cancel TAM mode
51#		Set TAM mode
60#		Cancel ICM forwarding mode
61#		Set ICM forwarding mode**
89#		Delete voice memo/all ICM messages
99#		End remote control

* Sub-commands are only valid while the command they are linked to is active.

** When no forwarding number has been set, ICM forwarding mode cannot be set. When TAM mode has not been set, entering this command activates TAM mode and ICM forwarding mode simultaneously.

Forwarding Telephone Messages

This feature allows you to automatically forward telephone messages, recorded when the fax is set to TAM mode, to a registered forwarding number.

You can use remote control to access the forwarding number and listen to your telephone messages.

Note

- You must register a forwarding number and set TAM mode before you can use this feature. Remote control cannot be used to set this feature unless a forwarding number has been registered.
 - If you set <FWD SETTINGS> to <ON> when a forwarding message has not been recorded, you will hear a tone instead of a forwarding message when telephone messages are forwarded.
-

■ Setting the Forwarding Number

- 1 Press [Menu].
- 2 Use [▲] or [▼] to select <DATA REGISTRATION>, then press [Start/Copy]. The LCD displays <USER SETTINGS>.
- 3 Use [▲] or [▼] to select <TAM SETTINGS>, then press [Start/Copy]. The LCD displays <MESSAGE LENGTH>.
- 4 Use [▲] or [▼] to select <FWD SETTINGS>, then press [Start/Copy]. The LCD displays <OFF>.
- 5 Use [▲] or [▼] to select <ON>, then press [Start/Copy] twice. The LCD displays <TEL=>.
- 6 Use the numeric buttons to enter the forwarding number, then press [Start/Copy].
A maximum of 40 digits can be entered.
- 7 Press [Stop/Reset].
Setting ends and the fax returns to standby mode.

■ Setting the Number of Redial Times

- 1 Follow steps 1 to 4 in “Setting the Forwarding Number” on page 50.
- 2 Use [▲] or [▼] to select <ON>, then press [Start/Copy]. The LCD displays <FWD TEL NUMBER>.
- 3 Use [▲] or [▼] to select <AUTO REDIAL>, then press [Start/Copy]. The LCD displays <ON>.
- 4 Use [▲] or [▼] to select <ON>, then press [Start/Copy] twice. The LCD displays <2TIMES>.
- 5 Use the numeric buttons, or [▲] or [▼] to enter the number of redial times, then press [Start/Copy] twice. The LCD displays <2MIN.>.

- 6 Use the numeric buttons, or [▲] or [▼] to enter the redial interval, then press [Start/Copy].
- 7 Press [Stop/Reset].
Setting ends and the fax returns to standby mode.

■ Setting <PIN ENTRY>

If you set the <PIN ENTRY> setting to <ON>, you must enter a password to use the forwarding feature (see page 51).

- 1 Follow steps 1 to 4 in “Setting the Forwarding Number” on page 50.
- 2 Use [▲] or [▼] to select <ON>, then press [Start/Copy]. The LCD displays <FWD TEL NUMBER>.
- 3 Use [▲] or [▼] to select <PIN ENTRY>, then press [Start/Copy]. The LCD displays <ON>.
- 4 Use [▲] or [▼] to select <ON>, then press [Start/Copy].
- 5 Press [Stop/Reset].
Setting ends and the fax returns to standby mode.

When a Forwarded Call is Received

When <FWD SETTINGS> is set to <ON>, telephone messages recorded when the fax is set to TAM mode will be automatically forwarded to a registered forwarding number.

- 1 A call is received at the forwarding number.
- 2 When you answer the phone you will hear your forwarding message.
- 3 Press [#] while the forwarding message is playing.
If you have not set a forwarding message, press [#] when you hear the tone.
- 4 Enter your password when you hear the beeps.
 - When <PIN ENTRY> is set to <OFF> (see page 51), step 4 is not required.
 - If you enter an invalid password, you will hear an error tone. If you enter two invalid passwords consecutively, the call will be disconnected.
- 5 Any new telephone messages will be played.
- 6 When playback ends, it will be possible to use the remote control features.
For the remote control features, see page 47.
- 7 Hang up the Handset when you have finished.

 **Note**

- **When forwarding is not possible:**

You can set the fax to redial the forwarding number a certain number of times at specified intervals when forwarding is not possible, such as at times when the forwarding number is busy or the phone is unattended. If forwarding is still not possible after the fax redials the forwarding number the specified number of times, the forwarding setting will be temporarily canceled. However, the fax will dial the forwarding number again when any new telephone messages are received.

- After any recorded messages have finished playing, if you do not enter a remote command, the call will be disconnected.
-

Printing from Your Computer

Printing from Your Computer

This section describes procedure for basic printing.

Important

Before printing from your computer, install the printer driver to the computer to connect the machine and the computer. Refer to your setup sheet or “Installing the Printer Driver” on page 9.

Note

- Only plain paper can be used for this machine.
- Custom sized paper can also be loaded as well as A4, Letter, and LGR-sized. For details, refer to the *On-screen Manual*.

- 1 Create a document or open a file to print using an appropriate application software.
- 2 Select **Print** on the application software’s **File** menu.
- 3 Make sure that your machine’s name is selected in **Select Printer**, and click **Preferences** (or **Properties**).

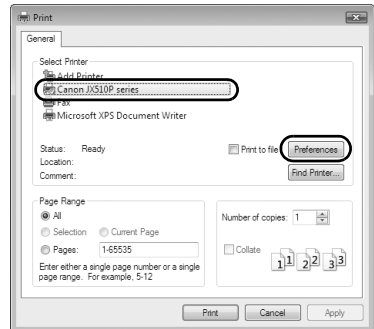

- 4 Specify the required settings and click **OK**.

Note

For details on the printer driver functions, click **Help** or **Instructions** to view the online help or the *On-screen Manual*. **Instructions** is only displayed when the *On-screen Manual* is installed.

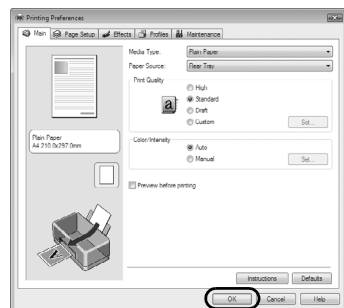

- 5 Click **Print** (or **OK**).

Note

If straight lines are misaligned or print quality is not satisfactory after installing the printer driver, you may need to align the Print Head. Refer to “Aligning the FINE Cartridge” on page 67.

Reading the On-screen Manual

For detailed instructions on installing the *On-screen Manual*, refer to your setup sheet.

You can view the *On-screen Manual* in the following way:

To view the *On-screen Manual*, double-click the **XXX On-screen Manual** shortcut icon on the desktop, or click **Start > All Programs (or Programs) > Canon XXX Manual > XXX On-screen Manual** (where "XXX" is your machine's name).

System Requirements

Browser: Easy Guide Viewer

Note

- Microsoft Internet Explorer 6.0 or later must be installed.
 - The *On-screen Manual* may not be displayed properly depending on your operating system or Internet Explorer version. We recommend that you keep your system up to date with Windows Update.
-

Settings and Activity Reports

Selecting a Menu

The <USER SETTINGS>, <REPORT SETTINGS>, <TX SETTINGS>, <RX SETTINGS>, <PRINTER SETTINGS>, <SYSTEM SETTINGS>, <TAM SETTINGS>*, and <CALLER ID> menus allow you to customize the way your fax works. Each menu contains settings that control different functions of your fax.

- 1** Press [Menu].
- 2** Use [▲] or [▼] to select <DATA REGISTRATION>, then press [Start/Copy]. The LCD displays <USER SETTINGS>.
- 3** Use [▲] and [▼] to scroll through the menus and select the menu you want. You can select the <USER SETTINGS>, <REPORT SETTINGS>, <TX SETTINGS>, <RX SETTINGS>, <PRINTER SETTINGS>, <SYSTEM SETTINGS>, <TAM SETTINGS>* or <CALLER ID> menu (see page 56).
- 4** Press [Start/Copy] to access the settings under the menu you selected.
- 5** See the tables on the following pages (see page 56) for guidelines on selecting and registering settings.
 - Use [▲] and [▼] to scroll through the settings.
 - To register a setting or access a sub-setting, press [Start/Copy].
 - To return to a previous level, press [Menu].
- 6** Press [Stop/Reset].

Setting ends and the fax returns to standby mode.

Note

- If at any stage you want to return to standby mode, press [Stop/Reset].
 - If you pause for more than 120 seconds while accessing a menu, the fax will automatically return to standby mode.
-

* JX510P only.

■ USER SETTINGS

Name	Description	Settings
DATE & TIME	Set the date and time (24-hour clock) using the numeric buttons.	–
UNIT TELEPHONE #	Enter your fax number using the numeric buttons.	–
UNIT NAME	This is the name that appears at the top of each fax page you send (see page 15).	–
TX TERMINAL ID	This option sets the parameters for the identification header that appears on every page you send.	ON/OFF
FAX/TEL No. MARK	Select the icon for the fax number.	FAX/TEL
TTI POSITION	Select the position of the TTI.	OUTSIDE IMAGE/ INSIDE IMAGE
SCAN CONTRAST	Set the density of the reproduction.	STANDARD/ DARKER/ LIGHTER
OFFHOOK ALARM	Enable/disable the off hook alarm. The alarm alerts you that the Handset is not seated properly in its cradle.	ON/OFF
VOLUME CONTROL	Set the volume of the fax sounds.	–
CALLING VOLUME	Set the volume of the ring sound.	0 (off)/1/2/3
LINE MONITOR VOL	Set the volume of the line monitor (sound during dialing).	0 (off)/1/2/3
ALARM VOLUME	Set the volume of the error alarm sound.	0 (off)/1/2/3
KEYPAD VOLUME	Set the volume of the keypad.	0 (off)/1/2/3
HANDSET VOLUME*	Set the volume of the Handset. This setting can be changed during a call, with [▲] or [▼].	1/2
RX CALL LEVEL	Set the ring tone.	STANDARD/HIGH
TEL LINE TYPE*	Set the dialing method the fax uses to match the type of phone line you have.	TOUCH TONE/ ROTARY PULSE
COPY RATIO	Set the enlargement and reduction and ratio for copying.	100% AS IS/86%/70%/ 50% MIN/200% MAX/ 141%/115%
DIAL SECURITY	Enable/disable the dial security. When it is ON, it will ask you to dial the number twice to prevent dialing the wrong number. The fax will dial the number after confirming the number you dialed in twice are matched.	ON/OFF

* Only available in some countries.

■ REPORT SETTINGS

Name	Description	Settings
TX REPORT	Enable/disable automatic printing of the transmission report.	–
PRINT ERROR ONLY:	Print only when an error occurs during sending.	–
OUTPUT YES:	ATTACH TX IMAGE: Print a transmission report attaching its image. Set the fax to print a transmission report every time you send a document. ATTACH TX IMAGE: Print a transmission report attaching its image.	YES/NO YES/NO
OUTPUT NO:	Turn off the transmission report feature.	–
RX REPORT	Enable/disable automatic printing of the reception report.	PRINT ERROR ONLY/ OUTPUT YES/ OUTPUT NO

Name	Description	Settings
ACTIVITY REPORT	Enable/disable automatic printing of the ACTIVITY REPORT.	–
AUTO PRINT	When you set ON, your fax is set to print the ACTIVITY REPORT for every 20 transactions (sending and receiving).	ON/OFF
TX/RX SEPARATE	Divide the activity management report into sent and received transactions.	ON/OFF

■ TX SETTINGS

Name	Description	Settings
ECM TX	Enable/disable error correction during transmission.	ON/OFF
PAUSE TIME	Set the length of the pause you insert into a dialing sequence.	1 to 9 seconds*
AUTO REDIAL	Determine whether the fax will redial a number if it fails to get a response on the first attempt.	ON/OFF
REDIAL TIMES	Set the number of retries.	1 to 10 times*
REDIAL INTERVAL	Set the period of time between redialing attempts.	2 to 99 minutes
DIAL TONE DETECT**	Set whether to send faxes after detecting the dial tone. This function may not work correctly with some telephone lines.	ON/OFF

* The values may differ depending on the country/region of use.

** Only available in some countries.

■ RX SETTINGS

Name	Description	Settings
ECM RX	Enable/disable error correction during reception.	ON/OFF
FAX/TEL AUTO SW	This feature is used to answer calls, and if no fax tone is detected, the fax rings to alert you of an incoming call.	–
RING START TIME	Set the duration that the fax listens for a fax tone before starting to ring.	0 to 20 seconds
TEL RING TIME	Set the length of time the fax will ring to alert you of an incoming call.	10 to 60 seconds*
DEFAULT ACTION	Select the action taken after the TEL RING TIME expires.	DISCONNECT/ RECEIVE
INCOMING RING	Set the fax to ring when it receives a call.	ON/OFF
RING COUNT	Set the number of incoming rings before the fax answers.	2 to 30 times*
MAN/AUTO SWITCH	Determine if the fax switches to document receive mode after the fax rings for a specified time when the fax is in the manual receive mode.	ON/OFF
RING TIME	Set the amount of time the fax will ring before switching to document receive mode.	1 to 60 seconds
REMOTE RX	Enable/disable remote receiving.	ON/OFF
REMOTE RX ID	If you set REMOTE RX to ON, you can select the remote receiving ID.	00 to 99
SAVE RX IMAGE	Set whether to save images received.	ON/OFF
OPTION SETTINGS	Set whether the fax prints out received documents even when the ink level is low. Faxes will be deleted from memory after printing. If there is no ink left, the information contained in the fax will be lost. This setting will be retained even if the FINE cartridge is replaced with a new cartridge.	ON/OFF

* The values may differ depending on the country/region of use.

■ PRINTER SETTINGS

Name	Description	Settings
RX REDUCTION REDUCE DIMENSION	Enable/disable reduction for received documents. Select reduction in height only or both width and height.	ON/OFF VERTICAL ONLY/ HORIZ & VERTICAL
PAPER SIZE	Select the size of the loaded fax paper.	A4/LTR/LGL
INK SAVER	Set the ink saver mode.	ON/OFF
AUTO PRINT	Set whether to print received faxes, ACTIVITY REPORT, TX REPORT, RX REPORT, MULTI TX REPORT and MEMORY CLEAR REPORT automatically.	ON/OFF

■ SYSTEM SETTINGS

Name	Description	Settings
RX RESTRICTION RX CONDITION	Enable/disable the direct mail preventive function. WITH SENDER INFO: The fax only receives documents that contain TTI information. REGISTERED SENDR: The fax only receives documents that contain TTI information. Also, the phone/fax numbers on the TTI must be registered under one-touch/coded speed dialing on your fax.	ON/OFF WITH SENDER INFO/ REGISTERED SENDR
DATE DISPLAY	Set the date format.	DD/MM YYYY YYYY MM/DD MM/DD/YYYY
SELECT LANGUAGE	Set the language of the LCD messages.	ENGLISH/GERMAN/ FRENCH/ITALIAN/ SPANISH/DUTCH/ PORTUGUESE/ NORWEGIAN/ SWEDISH/DANISH/ FINNISH/RUSSIAN/ CZECH/HUNGARIAN/ POLISH/SLOVENE/ CHINESE
TX START SPEED	Set the speed at which the fax starts transmitting. Set this to a lower speed if you have difficulties connecting over long distance or noisy lines.	33600bps*/14400bps/ 9600bps/7200bps/ 4800bps
RX START SPEED	Set the speed at which the fax starts receiving. Set this to a lower speed if you have difficulties connecting over long distance or noisy lines.	33600bps*/14400bps/ 9600bps/7200bps/ 4800bps
COUNTRY SELECT**	Set the country.	UK/GERMANY/ FRANCE/ITALY/SPAIN/ HOLLAND/DENMARK/ NORWAY/SWEDEN/ FINLAND/AUSTRIA/ BELGIUM/ SWITZERLAND/ PORTUGAL/IRELAND/ GREECE/ LUXEMBOURG/ HUNGARY/CZECH/ RUSSIA/SLOVENIA/ POLAND/SOUTH AFRICA/SAUDI ARABIA/JORDAN/ OTHERS

* JX510P only.

** Only available in some countries.

Name	Description	Settings
DAYLIGHT SAV TIME	Enable/disable the summer time system.	ON/OFF
START DATE/TIME	Set the beginning of the summer time period.	-
END DATE/TIME	Set the end of the summer time period. MONTH: Set the beginning/end month. WEEK: Set the beginning/end week. DAY: Set the beginning/end day of the week. TIME: Set the beginning/end time.	- MARCH/APRIL/MAY/ JUNE/JULY/AUGUST/ SEPTEMBER/ OCTOBER/ NOVEMBER/ DECEMBER/ JANUARY/FEBRUARY LAST WEEK/ FIRST WEEK/ SECOND WEEK/ THIRD WEEK/ FOURTH WEEK SUNDAY/MONDAY/ TUESDAY/ WEDNESDAY/ THURSDAY/FRIDAY/ SATURDAY -

■ TAM SETTINGS (JX510P only)

Name	Description	Settings
MESSAGE LENGTH	Set the maximum recording time for each recorded message.	0 SECONDS/ 60 SECONDS/ 120 SECONDS/ 240 SECONDS
PASSWORD	Set a four-digit PIN so that you can access the fax from remote locations.	0000 to 9999
TOLL SAVER	Set the fax to answer after 2 rings if there are new messages. If there are no new messages the fax will answer after 5 rings.	ON/OFF
RING COUNT	If you set TOLL SAVER to OFF, this feature allows you to set the number of times the fax rings.	2 to 30 times*
FWD SETTINGS	Allows you to forward messages.	ON/OFF
FWD TEL NUMBER	Forwarding telephone number. A maximum of 40 digits can be entered.	-
AUTO REDIAL	Redial the previously dialed number. REDIAL TIMES: Set the number of retries. REDIAL INTERVAL: Set the period of time between redialing attempts.	ON/OFF 1 to 10 times 2 to 99 minutes
PIN ENTRY	PIN confirmation.	ON/OFF
TAM MONITOR	Allows you to screen all incoming calls.	ON/OFF

* The values may differ depending on the country/region of use.

■ CALLER ID

Name	Description	Settings
CALLER ID*	Determine if the fax displays the caller's name and phone/fax number when receiving a call.	ON/OFF
CALL REJECTION**	<p>ANONYMOUS: Allows you to reject anonymous calls.</p> <p>REJECTION METHOD: Select either to be disconnected without notice or to be disconnected after the outgoing message is played.</p> <p>SELECTIVE: Allows you to reject calls from specific numbers.</p> <p>REJECTED NUMBER (00-09): Set the phone/fax numbers to be rejected. A maximum of 20 digits can be entered. Press [Start/Copy] to set to the maximum 10 rejected number.</p> <p>REJECTION METHOD: Select either to be disconnected without notice or to be disconnected after the outgoing message is played.</p> <p>OUT OF AREA: Allows you to reject out-of-area calls.</p> <p>REJECTION METHOD: Select either to be disconnected without notice or to be disconnected after the outgoing message is played.</p> <p>SHOW IN HISTORY?: Determine if the fax stores the phone/fax numbers for rejected calls.</p>	<p>ON/OFF</p> <p>DISCONNECT/ PLAY MESSAGE</p> <p>ON/OFF</p> <p>—</p> <p>DISCONNECT/ PLAY MESSAGE</p> <p>ON/OFF</p> <p>DISCONNECT/ PLAY MESSAGE</p> <p>YES/NO</p>

* Only available in some countries.

** JX510P only.

Activity Reports

Your fax keeps track of most of its sending and receiving operations. These operations can be printed out in the form of activity reports that can help you check the dates and times of fax transmissions and whether or not each transaction was successful.

■ How to Print a Report

Depending on the type of report, you can have the fax print the report automatically, or you can print it directly. The TX REPORT, RX REPORT, MULTI TX REPORT, and MEMORY CLEAR REPORT* (see page 85) can only be printed automatically. See <REPORT SETTINGS> (page 56) on how and when reports are printed automatically.

Note

If the <AUTO PRINT> setting is set to <OFF>, the following will not be printed automatically: ACTIVITY REPORT, TX REPORT, RX REPORT, MULTI TX REPORT and MEMORY CLEAR REPORT. Refer to "Receiving to Memory Temporarily" on page 37.

- 1 Press [Menu].
- 2 Use [▲] or [▼] to select <REPORT>, then press [Start/Copy].
- 3 Use [▲] or [▼] to display the type of report you want to print, then press [Start/Copy].
You can select <ACTIVITY REPORT>, <1-TOUCH LIST>, <CODED DIAL LIST>, or <USER DATA LIST>.

* JX210P only.

■ ACTIVITY REPORT

Summarizes the information for the sending and receiving activities of your fax after 20 transactions. For automatic printing, see <ACTIVITY REPORT> on page 57.

Transactions in the ACTIVITY REPORT are listed chronologically.

■ ONE-TOUCH SPEED DIAL TELEPHONE NO. LIST

Lists the numbers and names registered under one-touch speed dialing buttons.

■ CODED SPEED DIAL TELEPHONE NO. LIST

Lists the numbers and names registered under coded speed dialing codes.

■ USER'S DATA LIST

Lists the current settings of the fax and the registered sender information.

■ MEMORY LIST

Lists the documents currently stored in the fax's memory (see page 40).

■ TX REPORT (Transmission Report)

Normally the fax does not print an activity report for transmitting, but you can set the fax to print an activity report every time you send a document. See <TX REPORT> on page 56.

You can set the fax to print an activity report only when an error occurs during transmitting. See <TX REPORT> on page 56.

■ RX REPORT (Reception Report)

Normally the fax does not print an activity report for receiving, but you can set the fax to print an activity report every time you receive a document. See <RX REPORT> on page 56.

You can set the fax to print an activity report only when an error occurs during receiving. See <RX REPORT> on page 56.

■ MULTI TX REPORT (Multi Transmission Report)

Lists the result of a sequential broadcasting.

If you set the fax to print the TX REPORT and then use sequential broadcasting, the MULTI TX REPORT will be printed instead of the TX REPORT. See <TX REPORT> on page 56.

Note

JX510P model:

Faxes or messages stored in the memory are backed up automatically if the power is turned off or fails. If however, the data cannot be retrieved when the power is turned on again, the MEMORY CLEAR REPORT is printed automatically.

JX210P model:

The MEMORY CLEAR REPORT is printed automatically when power is restored after a power failure. See "MEMORY CLEAR REPORT (JX210P only)" on page 85.

Routine Maintenance

Maintenance Menus

The table below shows the available maintenance menus when you press [Maintenance].

Menu
<CS CLEANING> (see page 69)
<NOZZLE CHECK> (see page 65)
<CLEANING> (see page 66)
<DEEP CLEANING> (see page 66)
<ALIGN PRINT HEAD> (see page 67)
<HEAD ALIGN VALUE> (see page 67)
<ROLLER CLEANING> (see page 70)
<BOTTOM CLEANING> (see page 70)

Note

You can also perform the maintenance operation from your computer. For details, refer to the *On-screen Manual*.

Replacing a FINE Cartridge

If there is no improvement with the quality of printing following such maintenance as FINE Cartridge Cleaning, the FINE Cartridge is probably empty. Replace the empty FINE Cartridge with a new one. When replacing a FINE Cartridge, check the model number very carefully.

■ Knowing When to Replace a FINE Cartridge

● When Ink is Low

When the ink level is low, <RECOMEND NEW CRT> is displayed on the LCD and the Ink Lamp lights up. In this state the FAX will receive documents to memory (up to 30 transactions or 120 pages (JX210P: 60 pages)) to prevent the information contained in the FAX from being lost if the ink runs out completely. You need to print out received faxes manually from the <MEMORY REFERENCE> menu.

After printing, delete unnecessary faxes from the memory. For more details, see “Documents Stored in Memory” on page 40.

● When Ink is Empty

When the ink is almost empty, <RECOMEND NEW CRT> is displayed on the LCD and the Ink Lamp blinks. When this occurs it may not be possible to clearly print received faxes from memory. When the ink is empty, <NO INK> is displayed on the LCD. Replace the FINE Cartridge with new one. For more details, see “Replacing a FINE Cartridge” on page 64.

Printing will resume as soon as the FINE Cartridge is replaced.

- Press [Stop/Reset] to cancel the current print job.

Replace the empty ink cartridge immediately after the printing. The resulting print quality is not satisfactory, if printing is continued under the ink out condition.

Note

- The resulting print quality may not be satisfactory, if printing is continued under this condition.
 - When the ink level is low, the print quality may become poor, and the machine will start storing incoming fax data in the memory.
 - The FAX cannot detect whether or not the received data are clearly printed on the paper.
 - The FAX automatically deletes the received fax data in the memory after printing them. We recommend you to set <SAVE RX IMAGE> to <ON> (see page 57). You can store the received fax data in the memory for no more than 30 transactions. Delete them before the memory becomes full.
-

● Setting Automatic Printing

When the ink is low, you can set the receiving fax either automatic printing or storing in memory.

- 1 Press [Menu].
- 2 Use [▲] or [▼] to select <DATA REGISTRATION>, then press [Start/Copy]. The LCD displays <USER SETTINGS>.
- 3 Use [▲] or [▼] to select <RX SETTINGS>, then press [Start/Copy]. The LCD displays <ECM RX>.
- 4 Use [▲] or [▼] to select <OPTION SETTINGS>, then press [Start/Copy]. The LCD displays <OFF>.
 - To disable ink low automatic printing, use [▲] or [▼] to select <OFF>.
 - To enable automatic printing, use [▲] or [▼] to select <ON>.
- 5 Press [Start/Copy].
- 6 Press [Stop/Reset].
The fax returns to standby mode.

■ What is a Low Ink Warning?

The machine counts the amount of ink used and when the remaining level reaches a preset level the Low Ink Warning lamp beside the LCD display lights up to advise you that the FINE Cartridge is running out of ink.

- When <RECOMEND NEW CRT>, or <NO INK> appears on the LCD.



The ink level of the FINE Cartridge showing <RECOMEND NEW CRT> is low. The ink level of the FINE Cartridge showing <NO INK> is empty. You should ensure you have a new FINE Cartridge.

- When <INK VOL UNKNOWN> appears on the LCD.

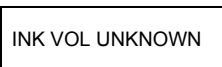

If you install the FINE Cartridge that was once empty, <INK VOL UNKNOWN> appears in the LCD. The function for detecting the remaining ink level will be disabled since the ink level cannot be correctly detected.

If you want to continue printing without this function, press [Stop/Reset] for at least 5 seconds.

However, the error detection function is disabled after the error indication is canceled, therefore, Low Ink Warning message does not appear later on. When you install a new FINE Cartridge, the Low Ink Warning is enabled automatically.

■ Replacing a FINE Cartridge

Note

- Do not replace the FINE Cartridge while the fax is printing or performing another operation.
- If you need to unplug the fax, wait until it returns to standby mode (time and receive mode displayed on the LCD). Otherwise the Holder may not be in its home position, causing the FINE Cartridge to remain uncapped and dry out.

- 1 Make sure the fax is turned on.
- 2 Open the Cover until it locks into place securely at the second bump.

Caution

- Do not try to manually move or stop the Holder.
- Do not touch the metallic parts or other parts inside the machine.

- 3 Remove the empty FINE Cartridge.

- (1) Push down the FINE Cartridge.
- (2) Remove the FINE Cartridge.

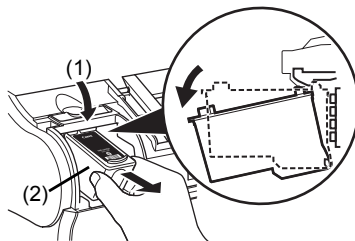

Important

- Handle FINE Cartridges carefully to avoid staining your clothes or surrounding area.
- Discard empty FINE Cartridges according to local laws and disposal regulations.

- 4 Prepare a replacement FINE Cartridge.

- (1) Unpack a new FINE Cartridge and remove the Protective Tape (A) gently.

Important

- Shaking FINE Cartridge may cause ink to spill out and stain clothing or the surrounding area. Handle FINE Cartridge carefully.
- Be careful not to stain your clothes and hands with ink on the removed protective tape.
- Do not reattach the Protective Tape once you have removed it.
- Once the Protective Tape is removed, do not touch the electrical contacts (B) or Print Head Nozzles (C) on the FINE Cartridge. The machine may not print out properly if you touch it.

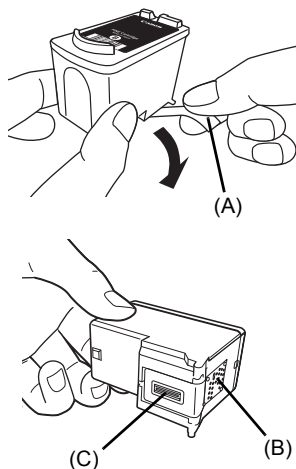

- 5 Insert the new FINE Cartridge.
 - (1) Insert the new FINE Cartridge slightly slanted.
 - (2) Push up the FINE Cartridge until it clicks into place.
- 6 Close the Cover.

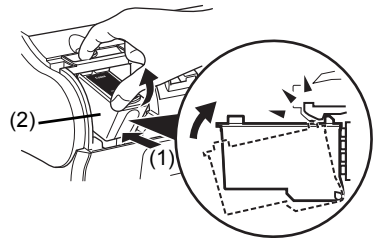

Important

- Canon recommends to use new genuine Canon cartridges in order to obtain optimum qualities.
- Replace the FINE Cartridge promptly. Do not leave with the FINE Cartridge removed.
- When a FINE Cartridge runs out of ink, replace the FINE Cartridge with a new one immediately. If you replace it with the FINE Cartridge that has previously been removed, the machine may not print properly due to clogged FINE Cartridge nozzles. Furthermore, the Low Ink Warning dialog box which advises when to exchange the FINE Cartridge will be inaccurate.
- To maintain optimal print quality, use up all the ink in the FINE Cartridge within six months of its first use (We recommend that you note the date that the FINE Cartridge was installed in the machine).
- Releasing the function for detecting the remaining ink level is memorized. Please be advised that Canon shall not be liable for any malfunction or trouble caused by continuation of printing under the ink out condition.

Note

- Load the paper in the Rear Tray before you replace the FINE Cartridge.
- The machine may make some operating noises when preparing to print. This is normal operation.

Testing and Cleaning the FINE Cartridge

The print head in the FINE Cartridge contains nozzles through which ink is propelled onto the paper. To maintain the best possible print quality, these nozzles need to be cleaned from time to time. Your fax is equipped with a print head cleaning function that does this.

■ Printing the Nozzle Check Pattern

Before cleaning the print head, you may want to print the nozzle check pattern to test the print head of the FINE Cartridge installed in the fax. This test shows if each print head nozzle is operating properly.

- 1 Load paper into the Rear Tray.
For details on loading paper in the Rear Tray, see "Loading Documents and Paper" on page 21.
- 2 Press [Maintenance].

- 3 Use [▲] or [▼] to select <NOZZLE CHECK>, then press [Start/Copy].
The fax prints the nozzle check pattern.

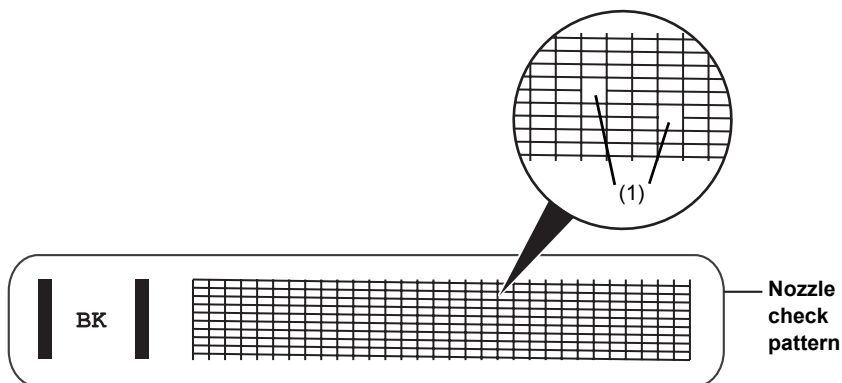

- 4 If the pattern is broken or missing (1), clean the FINE Cartridge print head (see page 66).

■ FINE Cartridge Cleaning

If the pattern is broken or missing, clean the FINE Cartridge print head.

Note

Cleaning the print head consumes a small amount of ink. Cleaning too often reduces the amount of ink in the FINE Cartridge.

- 1 Press [Maintenance].
- 2 Use [▲] or [▼] to select <CLEANING>, then press [Start/Copy].
The fax cleans the print head.

Note

- You can clean the print head up to five consecutive times if necessary.
- After cleaning, print the nozzle check pattern to check if cleaning corrected the problem (see page 65).
- If normal FINE Cartridge cleaning does not improve the print quality, perform deep FINE Cartridge cleaning (see page 66).

■ FINE Cartridge Deep Cleaning

If print quality does not improve after a standard Print Head Cleaning, try Print Head Deep Cleaning, which is a more powerful cleaning process.

Note

Print Head Deep Cleaning consumes more ink than standard Print Head Cleaning, so perform this procedure only when necessary.

- 1 Press [Maintenance].

- 2 Use [▲] or [▼] to select <DEEP CLEANING>, then press [Start/Copy].

 **Note**

- After cleaning, print the nozzle check pattern to check if cleaning corrected the problem (see page 65).
- If cleaning does not improve print quality, replace the FINE Cartridge (see page 64).

Aligning the FINE Cartridge

If ruled lines are printed misaligned or print results are otherwise unsatisfactory, adjust the print head position.

■ Print Head Alignment

- 1 Make sure that the machine is turned on, open the Document Cover, and extend the Paper Support.
- 2 Load a sheet of A4 or Letter-sized plain paper in the Rear Tray.
- 3 Press [Maintenance].
- 4 Use [▲] or [▼] to select <ALIGN PRINT HEAD>, then press [Start/Copy].
The machine prints the head alignment sheet.

 **Note**

Select <HEAD ALIGN VALUE> to print the current adjustment values.

- 5 Adjust the print head position.

- (1) Check the printed patterns and use [◀] or [▶] to input the number of the pattern in column A that has the least noticeable streaks.
▼
Press [Start/Copy].

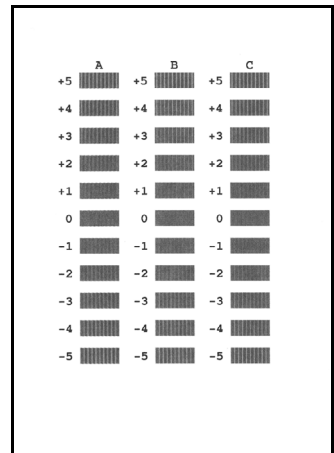

(2) Repeat the procedure to input inputting the pattern number for columns B and C.

 **Note**

If it is difficult to pick the best pattern, pick the setting that produces the least noticeable vertical white streaks.



(A)



(B)

(A) Less noticeable white streaks

(B) More noticeable white streaks

(3) When you have finished inputting all pattern numbers, the fax returns to standby mode.

 **Note**

When you turn off the machine, be sure to press [ON] on the machine. Otherwise, the settings made here will not be saved.

Cleaning Your Machine

Your fax requires little periodic maintenance. This section describes the necessary cleaning procedures for the fax. Please note the following before cleaning:

- Do not use tissue paper, paper towels, or similar materials for cleaning; they can stick to the components or generate static charges.
-

 **Caution**

Never use volatile liquids such as thinners, benzene, acetone, or any other chemical cleaner to clean the interior of the fax.

 **Note**

There is the case that some of the data are lost when the power is turned off for cleaning. See "In Case of a Power Failure" on page 85.

■ Cleaning the Exterior of the Machine

When cleaning the exterior of the machine, do not use tissue paper, rough-textured cloth, or similar materials, as these may scratch the surface. Also, never use volatile liquids such as thinners, benzene, acetone, or any other chemical cleaner to clean. Be sure to use a soft cloth such as eyeglasses cleaning cloth and wipe off dirt on the surface with it gently. Smooth out wrinkles on the cloth if necessary before cleaning.

 **Caution**

Always unplug the machine from the power outlet before cleaning the machine. If you accidentally switch the machine on while cleaning it, you could injure yourself.

■ Cleaning Inside of the Machine

To prevent ink spots and paper dust from accumulating inside the fax and affecting print quality, clean the print area of the fax periodically.

 **Caution**

Always unplug the machine from the power outlet before cleaning the machine. If you accidentally switch the machine on while cleaning it, you could injure yourself.

- 1 Open the Cover.

⚠ Caution

Do not touch the metallic parts or other parts inside the machine.

- 2 Use a clean, soft, dry, lint-free cloth to remove any ink or paper debris from the interior of the fax, especially around the four pinch rollers (A).

Dirt and dust particles that collect on the underside of the Cover affect the quality of the documents you copy or send.

Be careful not to touch the FINE Cartridge or Holder.

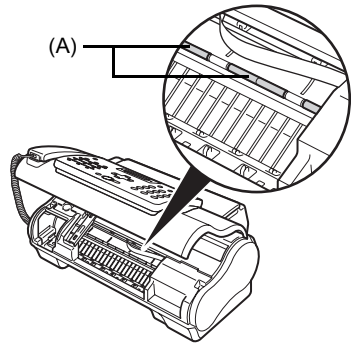

- 3 When you are finished, close the Cover.
Be sure to close the Cover until it locks into place.

■ Cleaning the Scanner Components

📖 Note

- If the scanner components are dirty, the documents you send or copy will also be dirty.
- Use a soft, lint-free cloth.
- Do not use tissue paper, paper towels, or similar materials for cleaning.

- 1 Press [Maintenance].
- 2 Use [▲] or [▼] to select <CS CLEANING>.
- 3 Press [Start/Copy].
- 4 Open the Cover.
- 5 While lifting the Scanning Unit Cover (A), with the White Sheet (B) inside exposed, clean the components.

Wipe with a clean, soft, lint-free cloth moistened with water, then wipe with a clean, soft, dry, lint-free cloth.

📖 Note

Do not bend the white sheet (B).

- 6 When you are finished, close the Cover.
Be sure to close the Cover until it locks into place.

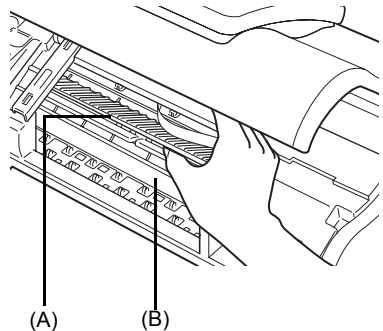

■ Cleaning the Roller

Clean the paper feed roller if paper is not fed properly. Cleaning the paper feed roller will wear the roller, so perform this only when necessary.

- 1 Ensure that the machine is turned on and there is no paper loaded in the Rear Tray.
- 2 Press [Maintenance].
- 3 Use [▲] or [▼] to select <ROLLER CLEANING>, then press [Start/Copy].
- 4 Repeat steps 2 to 3 twice.
- 5 Load three or more of A4- or Letter-sized paper in the Rear Tray.
- 6 Repeat steps 2 to 3 three times.
The sheet of paper is automatically fed in and then out of the machine.

■ Cleaning the Bottom Plate

If the printed paper is smudged, the inside of the machine may be dirty. Periodic cleaning of certain parts on the inside of your machine is recommended to maintain a high standard of printing quality.

- 1 Ensure that the machine is turned on and there is no paper loaded in the Rear Tray.
- 2 Take a sheet of A4 or Letter-sized plain paper and fold it in half widthwise. Then, open the paper.
- 3 Load it into the Rear Tray with the opened side facing up.

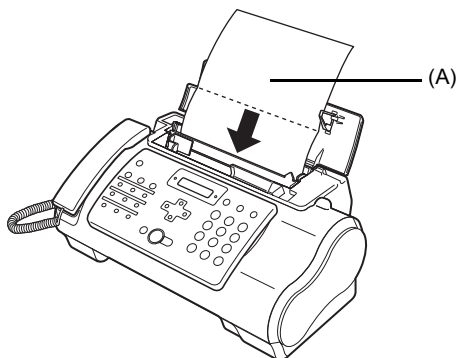

(A) Insert the paper open side

- 4 Press [Maintenance].
- 5 Use [▲] or [▼] to select <BOTTOM CLEANING>.
- 6 Press [Start/Copy].
Inspect the discharged paper. If dust or dirt can be seen on the paper, repeat the cleaning process.

■ Cleaning the Protrusions Inside the Machine

If protrusions inside the machine are stained, wipe ink off the protrusions using a swab or something similar.

⚠ Caution

Always unplug the machine from the power outlet before cleaning the machine. If you accidentally switch the machine on while cleaning it, you could injure yourself.

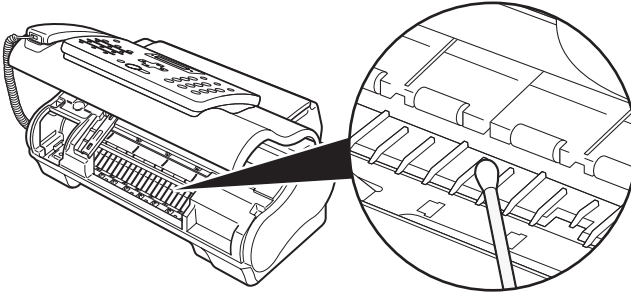

⚠ Important

Do not touch the transparent film (A), film cable (B), or any metal parts.

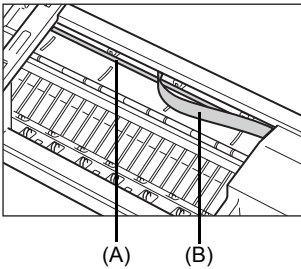

Troubleshooting

Paper Jams

■ Jams in the ADF

When a document jams or misfeeds in the ADF, either both <OPEN COVER> and <SEE FIG. 1> or only <CHK PRINTER 5100>/<SEE MANUAL> are displayed on the LCD.

Note

You do not need to unplug the fax when clearing document jams.

● When <OPEN COVER> and <SEE FIG. 1> are displayed alternatively

- 1 Press [Stop/Reset].

Important

Do not pull out the jammed paper manually at this point.

- 2 Hold down [Start/Copy] for a few seconds.
 - The document will be fed out automatically.
 - If the document is not fed out, gently pull the document out of the fax.

● When <CHK PRINTER 5100>/<SEE MANUAL> is displayed

- 1 Check if any paper is jammed.
If jammed, make sure to take out all the jammed paper.
- 2 After taking out jammed paper, turn the fax off, then turn it back on with [ON].

■ Jams in the Rear Tray

If paper jams in the Rear Tray, <CLEAR PAPER JAM> is displayed on the LCD.

- 1 Gently pull any jammed paper out of the fax as shown, then press [Stop/Reset].
 - Pull it gently in either direction.
 - If you cannot pull the paper out, proceed to step 2.

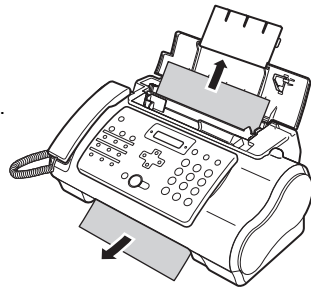

- 2 Open the Cover.
- 3 Gently remove the jammed paper inside the fax.
- 4 Press [Stop/Reset].
The fax returns to standby mode.

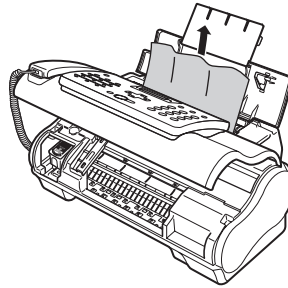

If the Power Disconnects Unexpectedly

The date and time setting on your device and all documents stored in memory* will be kept.

*All documents stored in memory will be deleted for the JX210P model.

If the power disconnects, the following will apply:

- You will not be able to send or receive faxes or make copies.
- If a telephone is connected to the machine, you can receive voice calls.
- Whether you are able to make voice calls or not depends on your telephone type.

Paper Feeding Problems

■ Paper Does Not Load

Cause	Action
The Rear Tray may contain too many sheets.	Make sure the paper stack in the Rear Tray does not exceed the paper limit mark (▶) (see page 21).
Paper may not be loaded correctly.	Make sure the paper stack is loaded properly in the Rear Tray, and that the Paper Guide is adjusted correctly (see your setup sheet or page 21).

■ Paper is Loaded Skewed (Printing is Skewed)

Cause	Action
Paper may not be loaded correctly.	<ul style="list-style-type: none"> ● Make sure the paper stack is loaded properly in the Rear Tray, and that the Paper Guide is adjusted correctly (see your setup sheet or page 21). ● Make sure the right edge of the paper stack is aligned with the right side of the Rear Tray and the Paper Guide is aligned with the left edge of the stack (see your setup sheet or page 21). ● Make sure the paper exit path is clear.

■ Multiple Sheets Load Into the Fax at the Same Time

Cause	Action
Paper may not be loaded correctly.	Make sure the paper stack is loaded properly in the Rear Tray, and that the Paper Guide is adjusted correctly (see your setup sheet or page 21).
Sheets of paper may be sticking together.	Be sure to tap the stack on a flat surface before loading it in the Rear Tray. This keeps the sheets of paper from sticking together.

Cause	Action
The Rear Tray may contain too many sheets.	<ul style="list-style-type: none"> ● Make sure the paper stack in the Rear Tray does not exceed the paper limit mark (▶) (see page 21). ● Do not exceed the maximum loading capacity of the Rear Tray (see page 92). ● Do not force the paper stack into the Rear Tray.
Different types of paper may be loaded in the Rear Tray.	<ul style="list-style-type: none"> ● Load only one type of paper. ● Make sure you load paper that meets the paper requirements for the fax (see page 20).

■ Repeated Paper Jams Occur

Cause	Action
The paper you are using may be causing the jams.	<ul style="list-style-type: none"> ● Be sure to tap the stack on a flat surface before loading it in the Rear Tray. This keeps the sheets of paper from sticking together. ● Check that the paper you are using and your printing environment are within the specifications of the fax (see page 20, page 92). ● Try loading a fresh stack of paper in the Rear Tray.

Faxing Problems

● Sending Problems

■ You Cannot Send a Document

Cause	Action
The FINE Cartridge may not be installed properly.	Make sure the FINE Cartridge is installed properly. Do not remove a used FINE Cartridge except to replace it with a new one.
The fax may have overheated.	Unplug the fax and let it cool for several minutes. Then plug it back in and try sending again.
The fax may not be set for the type of telephone line in use (pulse/tone).	Make sure the fax is set for the correct telephone line type (see page 14).
The document may not have been loaded correctly into the ADF.	<ul style="list-style-type: none"> ● Remove the document, stack it if necessary, and load it into the ADF correctly (see page 21). ● Make sure the Cover is closed.
The one-touch speed dialing button or coded speed dialing code you entered may not be registered for the feature you want to use.	Check the one-touch speed dialing button or coded speed dialing code and make sure it is registered correctly (see page 17).
You may have dialed or have been provided with an incorrect number.	Dial the number again, or check that you have the correct number.
The receiving party's fax machine may be out of paper.	Call the receiving party and ask them to make sure paper is loaded in their fax machine.
There may be other documents being sent from memory.	Allow time for those documents to finish sending.
An error may have occurred during sending.	Print the ACTIVITY REPORT and check for an error (see page 60).
The telephone line may not be working properly.	Make sure there is a dial tone when you press [Hook] or when you lift the Handset. If there is no dial tone, contact your local telephone company.
The receiving fax machine may not be a G3 fax machine.	Make sure the receiving fax machine is compatible with this fax machine (which is a G3 fax machine).

■ Documents Sent From the Fax are Spotted or Dirty

Cause	Action
The receiving fax machine may not be working properly.	Check the fax by making a copy (see page 22). If the copy is clear, the problem may be in the receiving fax machine. If the copy is spotted or dirty, clean the scanner components (see page 69).
The document may not have been loaded correctly into the ADF.	Remove the document, stack it if necessary, and load it into the ADF correctly (see page 21).

■ Cannot Send Using Error Correction Mode (ECM)

Cause	Action
The receiving party's fax machine may not support ECM.	If the receiving party's fax machine does not support ECM, then the document is sent in normal mode without error checking.
ECM may be disabled.	Make sure ECM is on (see <ECM TX> on page 57).

■ Errors Occur Frequently While Sending

Cause	Action
The telephone lines may be in poor condition, or you may have a bad connection.	Lower the transmission speed (see <TX START SPEED> on page 58).

● Receiving Problems

■ Cannot Receive a Document Automatically

Cause	Action
The fax may not be set to receive automatically.	For the fax to receive documents automatically, the receive mode must be set to <FAX ONLY MODE>, <Fax/Tel Mode>, <NET SWITCH>*, <ANS.MACHINE MODE> (see page 32), or TAM mode** must be set (see page 42). If you have set <ANS.MACHINE MODE>, check that an answering machine is connected to the fax and that it is turned on with an outgoing message properly recorded (see page 34).
The fax may have a document stored in memory.	Print out any documents stored in memory (see page 40).
An error may have occurred during reception.	<ul style="list-style-type: none"> ● Check the LCD for an error message (see page 85). ● Print the ACTIVITY REPORT and check for an error (see page 60).
The Rear Tray may be empty.	Make sure paper is loaded in the Rear Tray (see your setup sheet or page 21).
The telephone line may not be connected properly.	Make sure all line connections are secure (see your setup sheet).
The machine is under maintenance. / The machine is sending a fax. / The machine is printing another document.	Cancel sending, printing, or maintenance as soon as possible.

* Only available in some countries.

** JX510P only.

■ The Fax Does Not Switch Automatically Between Telephone and Fax Reception

Cause	Action
The fax may not be set to switch automatically between telephone and fax reception.	For the fax to switch automatically, the receive mode must be set to <Fax/Tel Mode>, <NET SWITCH>* or <ANS.MACHINE MODE> (see page 32), or TAM mode** must be set (see page 42). If you have set <ANS.MACHINE MODE>, check that an answering machine is connected to the fax and that it is turned on with an outgoing message properly recorded (see page 34).

Cause	Action
The fax may have a document stored in memory.	Print out any documents stored in memory (see page 40).
An error may have occurred during reception.	<ul style="list-style-type: none"> ● Check the LCD for an error message (see page 85). ● Print the ACTIVITY REPORT and check for an error (see page 60).
The Rear Tray may be empty.	Make sure paper is loaded in the Rear Tray (see your setup sheet or page 21).
The sending fax machine may not send the CNG signal that tells the fax that the incoming signal is a fax.	Some fax machines cannot send the CNG signal that tells your fax the incoming call is from a fax machine. In such cases, you will have to receive the document manually (see page 34).

* Only available in some countries.

** JX510P only.

■ Cannot Receive a Document Manually

Cause	Action
You may have disconnected the call by pressing [Start/Copy] or dialing the remote receiving ID after hanging up.	Always press [Start/Copy] or dial the remote receiving ID before hanging up the Handset, otherwise you will disconnect the call (see page 34).
The remote receiving ID may be incorrect.	Make sure you dialed the correct remote receiving ID (see page 34).

■ Print Quality is Poor

Cause	Action
You may not be using the correct type of paper.	Make sure you load paper that meets the paper requirements for the fax (see page 20).
The FINE cartridge print head may need cleaning.	Clean the FINE cartridge print head if necessary (see page 66).
The sending fax machine may not be functioning properly.	The sending fax machine usually determines the quality of the document. Call the sender and have them make sure their fax machine is functioning properly.
Error Correction Mode (ECM) may be disabled.	Make sure ECM is on (see <ECM RX> on page 57).

■ Fax Does Not Print

Cause	Action
The FINE Cartridge may not be installed properly.	<ul style="list-style-type: none"> ● Make sure the FINE Cartridge is installed properly (see your setup sheet or page 62). ● Be sure to remove the protective tape from the FINE Cartridge before you install it (see your setup sheet or page 62).
The FINE Cartridge print head may need cleaning.	Clean the FINE Cartridge print head if necessary (see page 66).
The FINE Cartridge may need to be replaced.	Determine if the problem is with the FINE Cartridge and replace if necessary (see page 62).
A document may be set.	Make sure a document is not set.
The machine is under maintenance. / The machine is sending a fax. / The machine is printing another document.	Cancel sending, printing, or maintenance as soon as possible.

■ Fax Images Print Blotched or Uneven

Cause	Action
The telephone lines may be in poor condition, or you may have a bad connection.	<ul style="list-style-type: none"> ● Error Correction Mode (ECM) sending/receiving should eliminate such problems. However, if the telephone lines are in poor condition, you may have to try again. ● Lower the reception speed (see <RX START SPEED> on page 58).
The sending fax machine may not be functioning properly.	The sending fax machine usually determines the quality of the document. Call the sender and have them make sure their fax machine is functioning properly.

■ Cannot Receive Using Error Correction Mode (ECM)

Cause	Action
The sending fax machine may not support ECM.	If the sending fax machine does not support ECM, then the document is received in normal mode without error checking.
ECM may be disabled.	Make sure ECM is on (see <ECM RX> on page 57).

■ Errors Occur Frequently While Receiving

Cause	Action
The telephone lines may be in poor condition, or you may have a bad connection.	Lower the reception speed (see <RX START SPEED> on page 58).
The sending fax machine may not be functioning properly.	Call the sender and have them check that their fax machine is functioning properly.

Copying Problems

■ The Fax Does Not Make a Copy

Cause	Action
The FINE Cartridge may need to be replaced.	Determine if the problem is with the FINE Cartridge and replace if necessary (see page 62).
The document may not have been loaded correctly into the ADF.	<ul style="list-style-type: none"> ● Remove the document, stack it if necessary, and load it face up into the ADF correctly (see page 21). ● Make sure the Cover is closed.
The FINE Cartridge may not be installed properly.	Make sure the FINE Cartridge is installed properly (see your setup sheet or page 62).
Print head nozzles are clogged.	Print the nozzle check pattern (see page 65).

■ <MEMORY FULL> Appears on the LCD When Making Multiple Copies

Cause	Action
The fax's memory is full.	<ul style="list-style-type: none"> ● Print or delete any documents stored in memory (see page 40) to free up space in the fax's memory, then start again. ● Change the scanning resolution and try copying again.
The document you are copying may have too many graphics.	If multiple pages are being copied, separate the pages into smaller stacks. If not, make the desired number of copies one at a time as needed.

Telephone Problems

■ You Cannot Dial

Cause	Action
The telephone line may not be connected properly.	Make sure all line connections are secure (see your setup sheet).
The power cord may not be plugged in securely.	Check that the power cord is plugged securely into the fax and into the wall outlet (see your setup sheet). If the fax is plugged into a power strip, make sure the power strip is plugged in and turned on.
The machine may not be switched on.	Press [ON] to turn the machine on.
The fax may not be set for the type of telephone line in use (pulse/tone).	Make sure the fax is set for the correct telephone line type (see page 14).

■ The Handset, Telephone, or Extension Phone Disconnects While You are Talking

Cause	Action
The telephone line cord may not be plugged in securely.	Check that the telephone line cord is plugged securely into the fax and into the telephone line jack on your wall.

■ There is Interference on the Line

Cause	Action
A mobile phone or cordless phone may be in use near the fax.	Make sure that mobile phones and cordless phones are not used near the fax.

Print Quality Problems

■ The Print Quality is Not What You Expect; Print is Not Clear, is Splashed, has Missing Dots or White Streaks

Cause	Action
The paper you are using may not be supported by the fax.	Make sure you are using the recommended paper (see page 20).
The nozzles on the FINE Cartridge print head may be clogged.	Clean the FINE Cartridge print head if necessary (see page 65).
The FINE Cartridge may not be installed properly.	Make sure the FINE Cartridge is installed properly (see your setup sheet or page 62).
The FINE Cartridge print head may be damaged.	Determine if the problem is with the FINE Cartridge print head (see page 65) and replace the FINE Cartridge if necessary (see page 62).

■ The Printout Contains Blurred or Smudged Ink



Cause	Action
The paper you are using may not be supported by the fax.	Make sure you are using the recommended paper (see page 20).

PC Printing Problems

● If an Error Occurs

When an error occurs in printing such as the machine is out of paper or paper is jammed, a troubleshooting message is displayed automatically. Take the appropriate action described in the message. The message may vary depending on the version of your operating system.

● Cannot Install the Printer Driver

Cause	Action
The installer is not compatible with your operation system.	Use the machine under an environment described in "Minimum System Requirements" on page 93.
Unable to proceed beyond the Printer Connection screen.	<p>If you are unable to proceed beyond the Printer Connection screen, make sure that the USB cable is securely plugged into the USB port of the machine and is connected to the computer, and then follow the procedure below to reinstall the printer driver.</p> <p> Note</p> <p>In Windows Vista, "The printer is not detected. Check the connection." may be displayed depending on the computer you use. In this case, wait for a while. If you still cannot proceed to the next step, follow the procedure below to reinstall the printer driver.</p> <ol style="list-style-type: none"> (1) Click Cancel on the Printer Connection screen. (2) Click Start Over on the Installation Failure screen. (3) Click Back on the screen that appears next. (4) Click Exit, then remove the CD-ROM. (5) Turn the machine off. (6) Restart your computer. (7) Make sure that you have no application software running. (8) Follow the procedure described in your setup sheet to reinstall the printer driver.
Installation does not start automatically when the <i>Setup CD-ROM</i> is inserted into your computer's disc drive.	<p>Start the installation following the procedure below.</p> <ol style="list-style-type: none"> (1) Click Start then Computer. In Windows XP: Click Start then My Computer. In Windows 2000: Double-click the My Computer icon on the desktop. (2) Double-click the CD-ROM icon on the displayed window. If the contents of the CD-ROM are displayed, double-click MSETUP4.EXE. <p> Note</p> <p>If the CD-ROM icon is not displayed, try the following:</p> <ul style="list-style-type: none"> ● Remove the CD-ROM from your computer, then insert it again. ● Restart your computer. <p>If the icon is still not displayed, try different discs and see if they are displayed. If other discs are displayed, there is a problem with the <i>Setup CD-ROM</i>. In this case, contact the service center.</p>
Installation procedure not followed correctly.	<p>Follow the procedure described in your setup sheet to reinstall the printer driver.</p> <p>If the printer driver were not installed correctly, uninstall the printer driver, restart your computer, and then reinstall the printer driver. For details, refer to the <i>On-screen Manual</i>.</p> <p>If you reinstall the printer driver, select Custom Install on the <i>Setup CD-ROM</i>.</p> <p> Note</p> <p>If the installer was forced to be terminated due to a Windows error, the system may be in an unstable condition and you may not be able to install the printer driver. Restart your computer before reinstalling.</p>

- **Cannot Connect to Computer Properly**
- **Printing or Scanning Speed Is Slow / Hi-Speed USB Connection Does Not Work / “This device can perform faster” Message Is Displayed**

Cause	Action
Your system environment is not fully compatible with Hi-Speed USB.	<p>If your system environment is not fully compatible with Hi-Speed USB, the machine will operate at a lower speed provided under USB 1.1. In this case, the machine operates properly but printing or scanning speed may slow down due to communication speed.</p> <p>Check the following to ensure that your system environment supports Hi-Speed USB connection.</p> <ul style="list-style-type: none"> ● The USB port on your computer supports Hi-Speed USB connection. ● The USB cable, and the USB hub if you are using one, support Hi-Speed USB connection. <p>Be sure to use a certified Hi-Speed USB cable. We recommend the cable to be no longer than around 10 feet / 3 meters.</p> <ul style="list-style-type: none"> ● The operating system of your computer supports Hi-Speed USB connection. Obtain and install the latest update for your computer. ● The Hi-Speed USB driver operates properly. Obtain the latest version of the Hi-Speed USB driver compatible with your hardware and install it on your computer. <p> Important For details on Hi-Speed USB of your system environment, contact the manufacturer of your computer, USB cable, or USB hub.</p>

- **Print Results Not Satisfactory**

If the print result is not satisfactory due to misaligned lines, confirm the paper and print quality settings first. For details, refer to the *On-screen Manual*.

- **Check 1: Confirm that the paper size setting matches the loaded paper size and that the loaded paper is plain paper.**

When the paper size setting is incorrect or other than plain paper is loaded, you cannot obtain a proper print result. Also, the printed surface may be scratched.

- **Check2: Make sure that the appropriate print quality is selected.**

Select a print quality option suitable for the printing data. If you notice blurs, increase the print quality setting and try printing again.

- **Check 3: If the problem is not resolved, there may be other causes.**

See also the sections below:

- “Cannot Print to End of Job” on page 80
- “Lines Are Misaligned” on page 81
- “Paper Is Smudged / Printed Surface Is Scratched” on page 81
- “Back of the Paper Is Smudged” on page 82

- **Cannot Print to End of Job**

Cause	Action
Size of the print data is extremely large.	Click Print Options on the Page Setup sheet. Then, select the Prevent loss of print data check box in the displayed dialog.
Insufficient space on your computer's hard disk.	Delete unnecessary files to free disk space.

■ Lines Are Misaligned

Cause	Action
The paper and print quality settings are not set properly.	Confirm the paper and print quality settings. See "Print Results Not Satisfactory" on page 80.
Print Head is misaligned.	If you did not align the Print Head after installation, straight lines may be printed misaligned. See "Aligning the FINE Cartridge" on page 67.
Size of the print data is extremely large.	Click Print Options on the Page Setup sheet. Then, select the Prevent loss of print data check box in the displayed dialog.
The Printing layout printing or Binding margin function is being used.	When the Printing layout printing or Binding margin function is being used, thin lines may not be printed. Try thickening the lines in the document.

■ Paper Is Smudged / Printed Surface Is Scratched



Cause	Action
The paper and print quality settings are not set properly.	Confirm the paper and print quality settings. See "Print Results Not Satisfactory" on page 80.
Printing on inappropriate type of paper.	Check to see if the paper you are printing on is suitable for your printing purpose. See "Paper Requirements" on page 20 to make sure that the paper you are using is suitable.
Paper is curled.	Turn the paper over and reload it to print on the other side. Leaving the paper loaded on the Rear Tray for a long time may cause the paper to curl. In this case, load the paper with the other side facing up. It may resolve the problem. We recommend putting unused paper back into the package and keeping it on a level surface.
Printing beyond the recommended printing area.	If you are printing beyond the recommended printing area of your printing paper, the lower edge of the paper may become stained with ink. Resize your original document in your application software. For details on recommended printing area, see "Paper Requirements" on page 20.
Inside of the machine is dirty.	Perform the Bottom Plate Cleaning to clean the inside of the machine. For details on cleaning, see "Cleaning Your Machine" on page 68.  Note To prevent the inside of the machine from getting stained, set the page size correctly.
Printed paper is taking long to dry.	Doing so gives the printed surface enough time to dry so that paper smudged and scratched are prevented. (1) Make sure that the machine is turned on. (2) Open the printer properties dialog box. Refer to the <i>On-screen Manual</i> . (3) Click the Maintenance tab and then Custom Settings . (4) Drag the Ink Drying Wait Time slide bar to set the wait time, and then click Send . (5) Confirm the message and click OK .
The paper is scratched by other loaded paper.	The paper may be scratched by other loaded paper when feeding from the Rear Tray. In this case, load one sheet at a time.
Printing graphics with the intensity setting set too high.	If you are printing images with high intensity, the paper may absorb too much ink and become wavy, causing paper abrasion. Reduce the Intensity setting in the printer driver and try printing again. (1) Open the printer properties dialog box. Refer to the <i>On-screen Manual</i> . (2) On the Main sheet, select Manual for Color/Intensity , and then click Set . (3) Drag the Intensity slide bar on the Color Adjustment sheet to adjust the intensity.

■ Back of the Paper Is Smudged



Cause	Action
The paper and print quality settings are not set properly.	Confirm the paper and print quality settings. See "Print Results Not Satisfactory" on page 80.
Inside of the machine is dirty.	Perform the Bottom Plate Cleaning to clean the inside of the machine. For details on cleaning, see "Cleaning Your Machine" on page 68.  Note To prevent the inside of the machine from getting stained, set the page size correctly.

● Machine Does Not Start or Stops During Print Jobs

■ Printing Does Not Start

Cause	Action
Unnecessary print jobs are left in queue. / Computer problems.	Restart your computer if you are printing from the computer. If there are any unnecessary print jobs, delete them. Refer to the <i>On-screen Manual</i> .
The machine is not ready.	Make sure that the power plug is securely plugged in, then turn the machine on. While [ON] is flashing green, the machine is initializing. Wait until [ON] stops flashing and remains lit green.  Note When printing large data such as a photo or graphics, it may take longer to start printing. While [ON] is flashing green, the computer is processing data and sending it to the machine. Wait until printing starts.
The machine is not connected properly.	Make sure that the USB cable is securely plugged in to the machine and the computer. <ul style="list-style-type: none"> ● If you are using a relay device such as a USB hub, disconnect it, connect the machine directly to the computer, and try printing again. If printing starts normally, there is a problem with the relay device. Consult the reseller of the relay device for details. ● There could also be a problem with the USB cable. Replace the USB cable and try printing again.
Your machine is not selected in the printer driver.	The machine will not print properly if you are using a driver for a different printer. Make sure that your machine's name is selected in the Print dialog box.  Note To make your machine the one selected by default, select Set as Default Printer .
The printer port is not configured appropriately.	Check the printer port settings. * In the following instruction, "XXX" signifies your machine's name. <ol style="list-style-type: none"> (1) Log into a user account with the administrator privilege. (2) Click Control Panel, then Printer under Hardware and Sound. In Windows XP: Click Control Panel, Printers and Other Hardware, then Printers and Faxes. In Windows 2000: Click Control Panel then Printers. (3) Right-click the Canon XXX icon, then select Properties. (4) Click the Ports tab to confirm the port settings. Make sure that a port named USBnnn (where "n" is a number) with Canon XXX appearing in the Printer column is selected for Print to the following port(s). If the setting is incorrect, reinstall the printer driver or change the printer port to the correct one.

■ Printing Stops Before It Is Completed

Cause	Action
Printing documents with plenty of photographs or illustrations.	<p>Printing large data such as photos or graphics takes time for the machine and the computer to process, during which the machine may appear to have stopped operating.</p> <p>In addition, when printing data that uses a large amount of ink continuously on plain paper, the machine may pause temporarily. In either case, wait until the process is complete.</p> <p> Note</p> <p>If you are printing a document with a large printing area or printing multiple copies of a document, printing may pause to allow the ink to dry.</p>
The machine has been printing continuously over a long period.	<p>If the machine has been printing continuously for a long time, the Print Head may overheat. To protect the Print Head, the machine may stop printing at a line break for a period of time and then resume printing.</p> <p>In this case, interrupt your print session at a convenient time and turn the machine off for at least 15 minutes.</p> <p>Additionally, if the machine has been printing graphics or photos with intense colors continuously over a period of time, the machine may stop printing to protect the Print Head. In this case, printing will not resume automatically. Turn the machine off for at least 15 minutes.</p> <p> Caution</p> <p>The Print Head and the surrounding area can become extremely hot inside the machine. Never touch the Print Head or nearby components.</p>
Paper may not be loaded correctly.	<p>Make sure that paper is loaded in the Rear Tray.</p> <p>If the machine has run out of paper, load paper.</p>

■ Printing Speed Not as Fast as Expected

Note

Printing speed may not improve noticeably by following the instructions below, depending on your system environment.

Cause	Action
Print quality is set too high.	<p>Change the print quality setting appropriately in the printer driver.</p> <p>(1) Open the printer properties dialog box. Refer to the <i>On-screen Manual</i>.</p> <p>(2) On the Main sheet, select Standard or Draft for the Print Quality setting.</p>

■ Printer Status Monitor Is Not Displayed

Cause	Action
Printer status monitor is not enabled.	<p>Make sure that Enable Status Monitor is selected on the Option menu of the printer status monitor.</p> <p>(1) Open the printer properties dialog box. Refer to the <i>On-screen Manual</i>.</p> <p>(2) On the Maintenance sheet, click View Printer Status.</p> <p>(3) Select Enable Status Monitor on the Option menu if it is not selected.</p>

■ The Inkjet Printer/Scanner/Fax Extended Survey Program Screen Is Displayed

If the Inkjet Printer/Scanner/Fax Extended Survey Program is installed, the confirmation screen asking to send the machine usage information will be displayed three months and then six months after the installation. After that, it will be displayed every half a year for about four years.

Read the instructions on the screen and follow the procedure below.

- If you agree to participate in the survey program:

Click **Agree**, then follow the on-screen instructions. The machine usage information will be sent to Canon via the Internet.

Note

When sending the information, the caution screen such as an Internet security screen may be displayed. In this case, confirm the program name is "IJPLMUI.exe", then allow it.

- If you do not agree to participate in the survey program:

Click **Do not agree**. The confirmation screen will be closed, and the survey at that time is skipped. The confirmation screen will be displayed again three months later.

- To uninstall the Inkjet Printer/Scanner/Fax Extended Survey Program:

To uninstall the Inkjet Printer/Scanner/Fax Extended Survey Program, click **Uninstall**. Once the program has been uninstalled, neither the survey nor the transmission of the machine usage information will be performed.

General Problems

■ The Fax has no Power

Cause	Action
The power cord may not be plugged in securely.	Check that the power cord is plugged securely into the fax and into the wall outlet (see your setup sheet). If the fax is plugged into a power strip, make sure the power strip is plugged in and turned on.
The power cord may not be supplying power.	Check the power cord by substituting with another.

■ The Fax will not Print Reports

Cause	Action
The FINE Cartridge may need to be replaced.	Determine if the problem is with the FINE Cartridge and replace if necessary (see page 62).

■ Nothing Appears on the LCD

Cause	Action
The power cord may not be plugged in securely.	Check that the power cord is plugged securely into the fax and into the wall outlet (see your setup sheet). If the fax is plugged into a power strip, make sure the power strip is plugged in and turned on. If the LCD remains blank, unplug the fax, wait five seconds, then plug it in again.
The LCD/LED may be in the power saver mode.	Press any button on the Operation Panel except for [ON] to restore the display.

■ Caller ID

Cause	Action
The caller's phone/fax number does not appear on the LCD.	<ul style="list-style-type: none"> ● See the contract details of your caller ID service. ● Check the settings of your machine. See "Setting Caller ID" on page 38. ● Depending on the line conditions, callers' phone/fax numbers may not be shown. ● The caller ID service may vary among countries/regions. For more information, contact your local telephone company.

In Case of a Power Failure

The user data settings and registered data for one-touch speed dialing and coded speed dialing are saved during a power failure.

JX510P model:

Faxes or messages stored in the memory are backed up automatically if the power is turned off or fails. If however, the data cannot be retrieved when the power is turned on again, the MEMORY CLEAR REPORT is printed automatically.

JX210P model:

The MEMORY CLEAR REPORT is printed automatically when power is restored after a power failure. This report includes a list of the documents that were stored in the memory at the time of power failure.

■ During a Power Failure

The following restrictions apply to the function of the fax during a power failure or while the power is turned off:

- You cannot use the fax to make telephone calls. Also if your fax is connected to a telephone, you may not be able to make telephone calls.
- You cannot send, receive, or copy documents.
- You can receive voice calls only if a telephone, or an extension phone is connected to your fax.

■ MEMORY CLEAR REPORT (JX210P only)

If you experience a power failure, the documents in the fax memory will be lost.

As soon as power is restored to the fax, it will automatically print out a list of the documents that were stored in the memory at the time of the power failure.

Note

If the cartridge is empty or there is no paper in the Rear Tray when power is restored, the MEMORY CLEAR REPORT will not be printed even after the cartridge is replaced or paper is loaded.

LCD Messages

The following messages are displayed on the LCD when the fax is performing a function or encounters an error.

■ AUTO PRINT OFF

Cause	Action
The <AUTO PRINT> setting has been set to <OFF>.	Set the <AUTO PRINT> setting to <ON> to print received faxes, ACTIVITY REPORT, TX REPORT, RX REPORT, MULTI TX REPORT, and MEMORY CLEAR REPORT automatically (see page 37).

■ AUTO REDIAL

Cause	Action
The fax is waiting to redial the receiving number because the line was busy or the receiving party did not answer when you tried to send the document.	Wait for the fax to automatically redial the number. If you want to cancel automatic redialing, press [Stop/Reset] (see page 28).

■ BUSY/NO SIGNAL

Cause	Action
The telephone number you dialed is busy.	Try sending the document at a later time.
The fax number dialed was incorrect.	Check the fax number and dial again.
The other party's fax machine is not working.	Contact the other party and have them check their fax machine.
The other party is not using a G3 machine.	Contact the other party and ask them to send or receive the document using a G3 machine.
The fax may not be set for the type of telephone line in use (pulse/tone).	Make sure the fax is set for the correct telephone line type (see page 14).
The receiving fax machine did not answer within 55 seconds (after all automatic redialing attempts).	Contact the receiving party and have them check their fax machine. You can try to send the document using manual sending (see page 23). For long-distance call, add pauses to the registered number (see page 27).

■ CHECK DOCUMENT

Cause	Action
The document is not set in the ADF, or has jammed.	Set the document you are trying to send or copy (see page 21), or check for a document jam and clear the jam if necessary (see page 72), and start again.

■ CHECK PAPER SIZE

Cause	Action
The size of the paper in the Rear Tray and that specified in the <PAPER SIZE> setting are different.	Load the correct paper size or change the <PAPER SIZE> setting (see page 58). Press [Stop/Reset].

■ CHK PRINTER 5100 / SEE MANUAL

Cause	Action
Movement of the Holder is blocked.	Clear the paper jam or foreign object that is preventing the Holder from moving, then turn off the machine and turn it back on again.
There may be an obstruction that is not allowing the Holder mechanism to move.	Check for any obstruction (paper clip, small object, etc.) and also that the protective tape are removed from the FINE Cartridge. Check also for a paper jam and clear the jam if necessary (see page 72). Then press [Stop/Reset] and start again.
The FINE Cartridge may be defective.	Press [Stop/Reset]. Reinstall the FINE Cartridge (see your setup sheet or page 62) and start again. In either case, if the error does not clear, try unplugging the fax. Wait several minutes, then plug it back in. Also, try replacing the FINE Cartridge with a new one (see page 62).
An error requiring servicing might have occurred.	Turn off the machine, and unplug the power cord of the machine from the power supply. After a while, plug the power cord of the machine back in and turn on the machine. If the same error occurs, contact the service center.

■ CHK PRINTER 5B00 / REQUIRE SERVICE

Cause	Action
The ink absorber (which holds the ink used for print head cleaning) may be full.	Contact the service center as early as possible.

■ CHK PRINTER B200 / REQUIRE SERVICE

Cause	Action
An error requiring servicing might have occurred.	If using the machine as phone, contact the service center, then turn off the machine immediately. If not using as phone, turn off the machine immediately, then contact the service center using your phone.

■ CHK PRINTER nnnn / SEE MANUAL

Cause	Action
An error requiring servicing might have occurred.	Turn off the machine, and unplug the power cord of the machine from the power supply. After a while, plug the power cord of the machine back in and turn on the machine. If the same error occurs, contact the service center.

■ CLEAR PAPER JAM

Cause	Action
There is a paper jam.	Clear the paper jam (see page 72) and reload paper in the Rear Tray. Press [Stop/Reset].

■ DOC. TOO LONG

Cause	Action
The document is longer than 400 mm.	Use a copier to make a reduced copy of the document and then send the copy.

■ ECM RX

Cause	Action
The fax is receiving a document using Error Correction Mode (ECM).	ECM receptions may take longer than normal receptions. Turn off ECM if you need to receive quickly, or if you know your local lines are in good condition (see <ECM RX> on page 57).

■ ECM TX

Cause	Action
The fax is sending a document using Error Correction Mode (ECM).	ECM transmissions may take longer than normal transmissions. Turn off ECM if you need to transmit quickly, or if you know your local lines are in good condition (see <ECM TX> on page 57).

■ INK ABS NEAR FUL

Cause	Action
The ink absorber is almost full.	Printing will no longer be possible once the ink absorber is full. Contact the service center immediately. Press [Stop/Reset] to continue printing.

■ INK VOL UNKNOWN

Cause	Action
The remaining level of the ink cannot be correctly detected.	A FINE Cartridge that was once empty is installed. Replace the FINE Cartridge (see page 62).

■ MEMORY FULL

Cause	Action
The fax's memory is full because it has received too many documents, or a very long or detailed document.	Print and delete any documents stored in memory (see page 40). Then start again.
The fax's memory is full because you either tried to send or copy too many pages at once, or you tried to send or copy a very long or detailed document, using memory sending.	Free up space in the fax's memory by printing or deleting any documents in memory you no longer need (see page 40). If multiple pages are loaded, separate the pages into smaller stacks. If not, try sending the document by direct sending (see page 23).
The total maximum recording time of 30 minutes has been reached (JX510P only).	Listen to your telephone messages and delete any unnecessary messages. Alternatively, erase all telephone messages stored in the fax memory (see page 46).

■ NO INK

Cause	Action
Ink has run out.	Replace the FINE Cartridge (see page 62).

■ NO OGM

Cause	Action
The outgoing message has not been recorded.	Record an outgoing message (see page 42).

■ NO TEL

Cause	Action
The one-touch speed dialing button or coded speed dialing code you entered has not been registered.	Register the one-touch speed dialing button or coded speed dialing code (see page 17).

■ REC'D IN MEMORY

Cause	Action
The fax received the document in memory because paper or ink ran out, a paper jam occurred, or the incorrect FINE Cartridge was installed.	Load paper in the Rear Tray (see your setup sheet or page 21), replace the FINE Cartridge (see page 62) or clear the paper jam (see page 72). Print any documents stored in memory (see page 40).
The fax receives documents in memory because the <AUTO PRINT> setting is set to <OFF>.	Set the <AUTO PRINT> setting to <ON>. This enables to print received faxes automatically (see page 37).

■ RECOMEND NEW CRT

Cause	Action
Ink is low.	Replace the FINE Cartridge (see page 62).

■ REMOVE DOCUMENT

Cause	Action
The document is set while printing.	Remove the document. Press [Stop/Reset] and try printing again.

■ SET DOCUMENT IN CORRECT POSITION

Cause	Action
The document cannot be correctly detected or the document is too small.	Make sure the document meets the requirements and is correctly loaded. If necessary, reload the document and press [Start/Copy]. See "Document Requirements" on page 19 and "Loading Documents and Paper" on page 21.

■ TAM MEMORY FULL*

Cause	Action
Either 55 messages, including an outgoing message, alternative message, voice memos, Fax/Tel message and forwarding message, have been recorded or the total maximum recording time of 30 minutes has been reached.	Listen to your telephone messages and delete any unnecessary messages. Alternatively, erase all telephone messages stored in the fax memory (see page 46).

* JX510P only.

■ TX/RX CANCELLED

Cause	Action
You pressed [Stop/Reset] to cancel the transmission.	If required, try sending again.

■ TX/RX NO. *nnnn*

Cause	Action
When the fax sends or receives a document, it assigns it a unique identification number (<i>nnnn</i>).	Write the number down if you will need it later.

Status Monitor Messages

The following messages are displayed on the status monitor when the machine is performing a function or encounters an error.

■ Service Error 5100 Is Displayed

Cause	Action
Movement of the Holder is blocked.	Clear the paper jam or foreign object that is preventing the Holder from moving, then turn off the machine and turn it back on again.
There may be an obstruction that is not allowing the Holder mechanism to move.	Check for any obstruction (paper clip, small object, etc.) and also that the protective tape are removed from the FINE Cartridge. Check also for a paper jam and clear the jam if necessary (see page 72). Then press [Stop/Reset] and start again.
The FINE Cartridge may be defective.	Press [Stop/Reset]. Reinstall the FINE Cartridge (see your setup sheet or page 62) and start again. In either case, if the error does not clear, try unplugging the printer. Wait several minutes, then plug it back in. Also, try replacing the FINE Cartridge with a new one (see page 62).
An error requiring servicing might have occurred.	Turn off the machine, and unplug the power cord of the machine from the power supply. After a while, plug the power cord of the machine back in and turn on the machine. If the same error occurs, contact the service center.

■ Service Error B200 Is Displayed

Cause	Action
An error requiring servicing might have occurred.	If using the machine as phone, contact the service center, then turn off the machine immediately. If not using as phone, turn off the machine immediately, then contact the service center using your phone.

■ Service Error nnnn Is Displayed

Cause	Action
An error requiring servicing might have occurred.	Turn off the machine, and unplug the power cord of the machine from the power supply. After a while, plug the power cord of the machine back in and turn on the machine. If the same error occurs, contact the service center.

■ Writing Error / Output Error / Communication Error

Cause	Action
The machine is not ready.	If [ON] is off, make sure that the power plug is plugged in, then turn the machine on. While [ON] is flashing green, the machine is initializing. Wait until [ON] stops flashing and remains lit green.
The machine is not connected properly.	Make sure that the USB cable is securely plugged into the machine and the computer. <ul style="list-style-type: none"> ● If you are using a relay device such as a USB hub, disconnect it, connect the machine directly to the computer, and try printing again. If printing starts normally, there is a problem with the relay device. Consult the reseller of the relay device for details. ● There could also be a problem with the USB cable. Replace the USB cable and try printing again.
Printer port setting does not match the computer's interface connecting the machine.	Make sure that the printer port is configured appropriately in the printer driver. <p>* In the following instruction, "XXX" signifies your machine's name.</p> <p>(1) Log on as a user account with the administrator privilege.</p> <p>(2) Click Control Panel, then Printer under Hardware and Sound. In Windows XP: Click Control Panel, Printers and Other Hardware, then Printers and Faxes. In Windows 2000: Click Control Panel then Printers.</p> <p>(3) Right-click the Canon XXX icon, then select Properties.</p> <p>(4) Click the Ports tab to confirm the port settings. Make sure that a port named USBnnn (where "n" is a number) with Canon XXX appearing in the Printer column is selected for Print to the following port(s). If the port setting is not correct, reinstall the printer driver or change the port setting according to the interface you are using.</p>
Printer driver is not installed properly.	The printer driver may not be installed properly. Uninstall them following the procedure described in the <i>On-screen Manual</i> and reinstall them following the procedure described in your setup sheet.

Cause	Action
<p>The printer port is not configured appropriately.</p>	<p>Follow the procedure below to check the status of the device.</p> <p>(1) Click Control Panel, Hardware and Sound, then Device Manager. If the User Account Control screen is displayed, follow the on-screen instructions.</p> <p>In Windows XP: Click Control Panel, Performance and Maintenance, System, then click Device Manager on the Hardware sheet.</p> <p>In Windows 2000: Click Control Panel, System, then Device Manager on the Hardware sheet.</p> <p>(2) Double-click Universal Serial Bus controllers then USB Printing Support. If USB Printing Support is not displayed, make sure that the machine is correctly connected to the computer. See "The machine is not connected properly." on page 90.</p> <p>(3) Click the General tab and make sure that there is no indication of a problem with the device. If a device error is displayed, refer to Windows help to resolve the error.</p>

■ Other Error Messages

Cause	Action
<p>One of the following Windows error messages is displayed outside the printer status monitor.</p>	<p>If an error message is displayed outside the printer status monitor, check the following:</p> <ul style="list-style-type: none"> ● “Could not spool successfully due to insufficient disk space” Delete any unnecessary files to increase the amount of free space on the disk. ● “Could not spool successfully due to insufficient memory” Quit other running applications to increase available memory. If you still cannot print, restart your computer and retry printing. ● “Printer driver could not be found” Uninstall the printer driver according to the procedure described in the <i>On-screen Manual</i>, and then reinstall it. ● “Could not print <i>Application name - File name</i>” Try printing again once the current job is complete.

Specifications

General Specifications	
Scanning sheet size	Width: Max. 216 mm Min. 105 mm Height: Max. 400 mm Min. 105 mm Thickness: Max. 0.13 mm (105 g/m ²) Min. 0.06 mm (40 g/m ²)
Effective scanning size	Width: A4: 208 mm
Effective printing size	Width: 203 mm
Transmission time	G3 ECM MMR: Approx. 3 seconds* ¹ (JX510P) / 6 seconds* ¹ (JX210P)
Scanning line density	Horizontal: 8 dots/mm Vertical Standard: 3.85 lines/mm Vertical Fine: 7.7 lines/mm
Recording method	Ink Jet printing
Paper tray capacity	Maximum: 11 mm (100 sheets with 75 g/m ² paper)
Paper type	Plain cut sheet paper (A4/Letter/Legal) Paper weight: 64 g/m ² to 105 g/m ² Paper thickness: 0.09 mm to 0.13 mm
Image memory	Up to 120 A4-size pages (JX510P)* ¹ * ² / 60 A4-size pages (JX210P)* ¹ (standard resolution)
Auto dial functions	One-touch speed dialing (Registration for 9 numbers) Coded speed dialing (Registration for 100 numbers (JX510P) / 60 numbers (JX210P))
Ink cartridges	Canon FINE Cartridge PG-40, Canon FINE Cartridge PG-50 (Option)
Power source	AC 100-240V, 50/60Hz
Power consumption	Sleep: Approx. 1.7 W (USB connection to PC) Maximum: Approx. 39 W
Operating environment	Temperature: 5 to 35°C Humidity: 10 to 90% RH (no condensation)
Dimensions	400 mm (W) x 269 mm (D) x 174 mm (H) (with the Handset placed, with the Document Cover closed)
Weight	Approx. 4.1 kg (with the Handset placed, with the FINE Cartridge installed)
Interface	USB Port: Hi-Speed USB* ³
Applicable line	Public Switched Telephone Network (PSTN)

Specifications are subject to change without notice.

*¹ Based on the Canon FAX Standard Chart No.1, Standard mode.

*² The number of pages may be reduced if many messages are stored in the TAM memory (JX510P only).

*³ A computer that complies with Hi-Speed USB standard is required. Since the Hi-Speed USB interface is fully upwardly compatible with USB 1.1, it can be used at USB 1.1.

Minimum System Requirements

Note

Conform to the operating system's requirements when higher than those given here.

Operating System	Windows Vista, Vista SP1
Processor	1 GHz processor
RAM	512 MB
	Windows XP SP2, SP3
	300 MHz processor
	128 MB
	Windows 2000 Professional SP4
	300 MHz processor
	128 MB
Browser	Internet Explorer 6.0 or later
Hard Disk Space	150 MB
	Note: For bundled software installation.
CD-ROM Drive	Required
Other restrictions	SVGA 800 x 600

- Operation can only be guaranteed on a PC with Windows Vista, XP or 2000 pre-installed.
- Some functions may not be available with Windows Media Center.
- To upgrade from Windows XP to Windows Vista, first uninstall software bundled with the Canon printer.

Additional System Requirements for On-Screen Manual

Browser: Easy Guide Viewer

Note: Microsoft Internet Explorer 6.0 or later must be installed. The *On-screen Manual* may not be displayed properly depending on your operating system or Internet Explorer version. We recommend that you keep your system up to date with Windows Update.

Specifications are subject to change without notice.

DECLARATION OF CONFORMITY

Multifunction Device JX510P, JX210P with AC Adapter and Ink Cartridge

We

Manufacturer; **Canon Inc.**30-2, Shimomaruko 3-chome Ohta-ku, Tokyo 146-8501, Japan, andAuthorized representative in Europe **Canon Europa N.V.**Bovenkerkerweg 59-61, 1185 XB Amstelveen, The Netherlands

declare under our sole responsibility that the product(s)

Multifunction Device; JX510P and JX210P (model:K10334)Ink Cartridges; PG-40, PG-50AC Adapter; K30307

is(are) in conformity with the essential requirements of EC Directive(s)

1999/5/EC

by applying the following standards

EC Directive (s)	Reference of standard(s) and amendment(s)
1999/5/EC	TBR 21: January 1998
	EN60950-1: 2001 with the following amendment(s) to this standard A11: 2004
	EN55022: 2006
	EN55024: 1998 with the following amendment(s) to this standard A1: 2001 and A2: 2003
	EN61000-3-2: 2006
	EN61000-3-3: 1995 with the following amendment(s) to this standard A1: 2001 and A2: 2005

Note:

1. The CE Marking is affixed from the year '08.
2. The quality system covering the production is implemented according to ISO 9000-Series (EN29000-Series) or monitored based on appropriate measures.
3. Copies of the rating plates of these models are attached.

Date: October 10, 2008

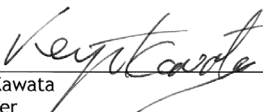

Keiji Kawata
Manager
IJD Safety/Regulation Advancement Dept.
IJ Quality Assurance Center
Canon Inc.

DECLARACIÓN DE CONFORMIDAD

Dispositivo multifunción JX510P y JX210P con adaptador CA y cartucho de tinta

Nosotros,

el Fabricante, **Canon Inc.**

30-2, Shimomaruko 3-chome Ohta-ku, Tokio 146-8501, Japón, y

nuestro representante autorizado en Europa, **Canon Europa N.V.**

Bovenkerkerweg 59-61, 1185 XB Amstelveen, Países Bajos

declaramos bajo nuestra exclusiva responsabilidad la conformidad de los productos

Dispositivo multifunción JX510P y JX210P (modelo K10334)

Cartuchos de tinta PG-40 y PG-50

Adaptador CA K30307

con los requisitos esenciales de la Directiva

1999/5/CE

mediante la aplicación de las siguientes normas

Directiva(s) CE	Indicación de las normas y sus enmiendas
1999/5/CE	TBR 21: enero de 1998
	EN60950-1:2001 con la siguiente enmienda a esta norma
	A11:2004
	EN55022:2006
	EN55024:1998 con las siguientes enmiendas a esta norma
	A1:2001 y A2:2003
	EN61000-3-2:2006
	EN61000-3-3:1995 con las siguientes enmiendas a esta norma
	A1:2001 y A2:2005

Nota:

1. El marcado CE de conformidad se colocó en estos productos en el año 2008.
2. El sistema de calidad que rige la producción se aplica de acuerdo con las normas de la Serie ISO 9000 (Serie EN29000) o se supervisa mediante medidas adecuadas.
3. Se adjuntan copias de las placas de características de estos modelos.

Fecha : 10 de octubre de 2008



Keiji Kayata
Director

Departamento de Fomento de las Normas de Seguridad de IJD

Centro de Aseguramiento de la Calidad de IJ

Canon Inc.

Traducción Jurada
Certified Translation

T. Cuesta 12/11/2008

Firmado/Signed: Tomás Miguel Cuesta González

Traductor-Intérprete Jurado de Inglés
Official English Translator-Interpreter

The following FINE Cartridges are compatible with this machine.

Die folgenden FINE-Patronen (FINE Cartridges) sind mit diesem Gerät kompatibel.

Les cartouches FINE (FINE Cartridges) suivantes sont compatibles avec cette machine.

De volgende FINE-cartridges (FINE Cartridges) zijn compatibel met dit apparaat.

Los siguientes cartuchos FINE (FINE Cartridges) son compatibles con este equipo.

Le cartucce FINE (FINE Cartridges) indicate di seguito sono compatibili con questo apparecchio.

Os cartuchos FINE (FINE Cartridges) seguintes são compatíveis com esta máquina.

Τα ακόλουθα φυσιγγία FINE (FINE Cartridges) είναι συμβατά με αυτό το μηχάνημα.

For details on FINE Cartridge replacement, refer to "Replacing a FINE Cartridge" in this guide.

Informationen zum Ersetzen einer FINE-Patrone (FINE Cartridge) finden Sie in diesem Handbuch unter „Ersetzen einer FINE-Patrone (FINE Cartridge)“.

Pour obtenir des informations détaillées sur le remplacement d'une cartouche FINE (FINE Cartridge), voir « Remplacement d'une cartouche FINE (FINE Cartridge) » dans ce guide.

Raadpleeg "Een FINE-cartridge (FINE Cartridge) vervangen" in deze handleiding voor meer informatie over het vervangen van een FINE-cartridge (FINE Cartridge).

Para obtener más información sobre la sustitución de cartuchos FINE (FINE Cartridge), consulte "Sustituir un cartucho FINE (FINE Cartridge)" en esta guía.

Per ulteriori informazioni sulla sostituzione della cartuccia FINE (FINE Cartridge), fare riferimento alla sezione "Sostituzione di una cartuccia FINE (FINE Cartridge)" del presente manuale.

Para obter detalhes sobre substituição do cartucho FINE (FINE Cartridge), consulte "Substituir um Cartucho FINE (FINE Cartridge)" neste guia.

Για λεπτομέρειες σχετικά με την αντικατάσταση του φυσιγγίου FINE (FINE Cartridge), ανατρέξτε στην ενότητα "Αντικατάσταση φυσιγγίου FINE (FINE Cartridge)" στο παρόν εγχειρίδιο.



CANON INC.

30-2, Shimomaruko 3-chome, Ohta-ku, Tokyo 146-8501, Japan

CANON EUROPA N.V.

Bovenkerkerweg 59-61 1185 XB Amstelveen The Netherlands

www.canon-europe.com