

PIXMA iP1000

Quick Start Guide

Table of Contents

Preface	1
Shipping Materials	1
Introduction	1
Setting Up	2
Preparing the Printer	2
Connecting the Printer to the Computer	3
Installing the Print Head	4
Loading Paper	7
Installing the Printer Driver	8
Basic Operations	13
Printing with Windows	13
Printing with Macintosh	15
Print Head Maintenance	17
Appendix	19
Notes on Handling the USB Interface (for Windows Users)	19
For Further Details...	19

Exif Print

This printer supports Exif Print.

Exif Print is a standard for enhancing the communication between digital cameras and printers. By connecting to an Exif Print-compliant digital camera, the camera's image data at the time of shooting is used and optimized, yielding extremely high quality prints.

Canadian Radio Interference Regulations

This digital apparatus does not exceed the Class B limits for radio noise emissions from a digital apparatus as set out in the interference-causing equipment standard entitled "Digital Apparatus," ICES-003 of the Industry Canada.

Cet appareil numérique respecte les limites de bruits radioélectriques applicables aux appareils numériques de Classe B prescrites dans la norme sur le matériel brouilleur NMB-003 d'Industrie Canada intitulée « Appareils numériques ».

International ENERGY STAR® Program

As an ENERGY STAR® Partner, Canon Inc. has determined that this product meets the ENERGY STAR guidelines for efficiency.



The International ENERGY STAR® Office Equipment Program is a global program that promotes energy saving through the use of computer and other office equipment. The program backs the development and dissemination of products with functions that effectively reduce energy consumption. It is an open system in which business can participate voluntarily. The targeted products are office equipment such as computers, monitors, printers, faxes and copiers. Their standards and logos are uniform among participating nations.

Power Requirements

Never use a power supply voltage other than that supplied in the country of purchase. Using the incorrect voltage could cause a fire or electric shock. The correct power supply voltages and frequencies are as follows:

AC 110-120 V, 50/60 Hz

AC 220-240 V, 50/60 Hz

Preface

Shipping Materials

Thank you for purchasing a Canon Bubble Jet Printer.

Check that all the following items are in the box. If anything is missing or is damaged, contact your local Canon sales representative.

- Printer
- Setup Software & User's Guide CD-ROM
- Quick Start Guide
- Print Head
- BCI-24 Black and BCI-24 Color Ink Tanks
- Power Cord

* A USB cable should be purchased separately according to your computer. For details on cable specifications, refer to page 3.

Introduction

This *Quick Start Guide* uses the following symbols to indicate important information. Always observe the instructions indicated by these symbols.

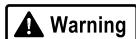

Warning

Instructions that, if ignored, could result in death or serious personal injury caused by incorrect operation of the equipment. These must be observed for safe operation.

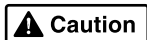

Caution

Instructions that, if ignored, could result in personal injury or material damage caused by incorrect operation of the equipment. These must be observed for safe operation.

Also read the Safety Precautions in the *User's Guide*. Observe the warnings and cautions to avoid personal injury or damage to the printer.

Trademark Notices

- Canon[®] is a registered trademark of Canon Inc.
- PIXMA and BJ is a trademark of Canon Inc.
- Microsoft[®] and Windows[®] are registered trademarks of Microsoft Corporation in the U.S. and other countries.
- Apple, Mac, Macintosh are trademarks of Apple Computer, Inc., registered in the U.S. and other countries.
- All other trademarks and registered trademarks appearing in this *Quick Start Guide* are the property of their respective owners.

Copyright ©2004 CANON INC.

All rights reserved. No part of this publication may be transmitted or copied in any form whatsoever without the express written permission.

Setting Up

1 Preparing the Printer

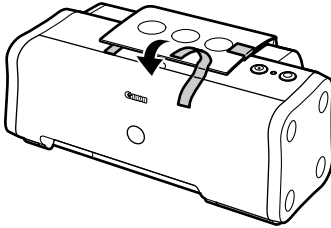

- 1** Place the printer on a flat surface.
- 2** Remove the tape from the printer as shown.

The tape position is subject to change.

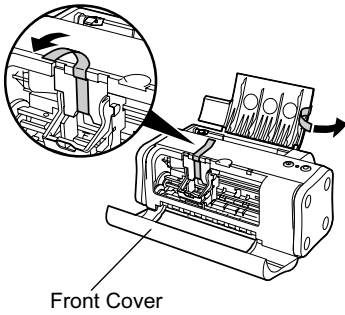

- 3** Open the Front Cover and remove the tape and the shipping material.
- 4** Close the Front Cover.

2 Connecting the Printer to the Computer

Use a USB cable.

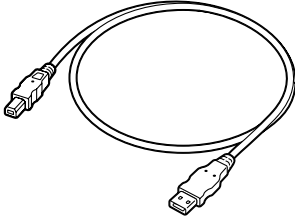

Recommended: Canon or other computer manufacturer cable, up to 5 meters in length.

Notes

- If your computer has an earth connection, make sure that this is attached.
- If you do not intend to use the printer for a long period of time, unplug the power cord from the power outlet after turning off the printer.

Follow the steps below to install the printer driver correctly.

- 1 Ensure that the printer and the computer are turned off.
- 2 Connect the cable.

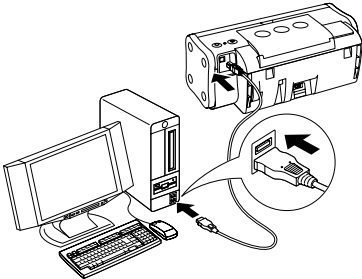

Note

If the **Add New Hardware Wizard** or **Found New Hardware Wizard** screen appears when carrying out the following operations, click **Cancel** and turn off the computer.



3 Installing the Print Head

Warning

- Never attempt to plug the power cord into the power outlet or unplug the power cord when your hands are wet.
- Never damage, modify, stretch, or excessively bend or twist the power cord. Do not place heavy objects on the power cord.
- Never use any power supply other than the standard power supply available in the country of purchase. Using the incorrect voltage and frequency could cause a fire or electric shock.
- Always push the plug all the way into the power outlet.

■ Installing the Print Head

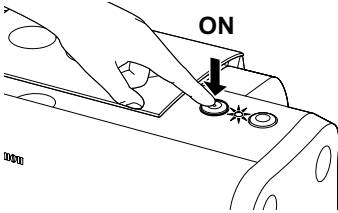

- 1** Plug the printer in.
- 2** Turn on the printer. Do NOT turn on the computer yet.

The POWER lamp flashes and the printer begins to operate. Wait until the POWER lamp remains fully lit.

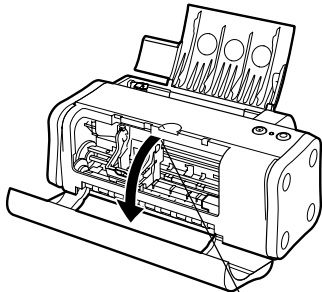

Print Head Holder

- 3** Open the Front Cover.

The Print Head Holder moves to the center.

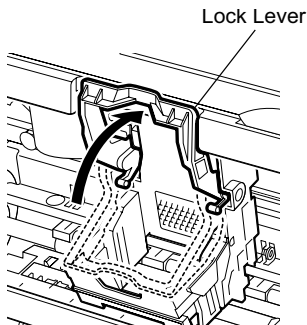

- 4** Raise the Lock Lever.

Do not touch internal parts other than the Lock Lever.

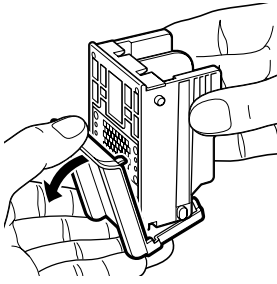

5 Remove the protective cap from the Print Head.

→ Notes

- Do not touch the Print Head Nozzles or electrical contacts.
- Do not attempt to reattach the protective cap once it has been removed.

Print Head
Nozzles electrical
 contacts

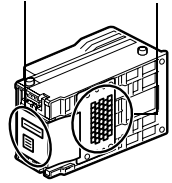

Print Head

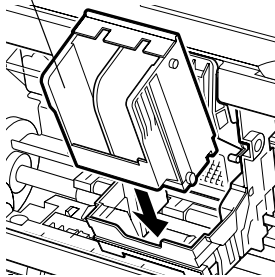

6 Place the Print Head in the holder.

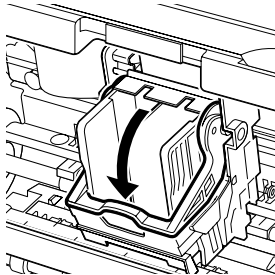

7 Lock the Print Head into place by lowering the lever.

Do not touch the Lock Lever once the Print Head has been installed.

■ Installing the Ink Tanks

⚠ Caution

- For safety reasons, store ink tanks out of the reach of small children.
- Do not drop or shake ink tanks as this may cause the ink to leak out and stain your clothes and hands.

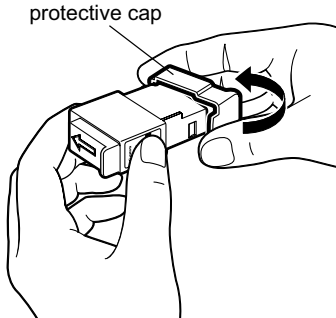

- 1** Take out the black ink tank.
- 2** Hold the ink tank as shown in the diagram and remove the protective cap.

→ Notes

- Do not touch the ink port.
- Do not attempt to reattach the protective cap once it has been removed.

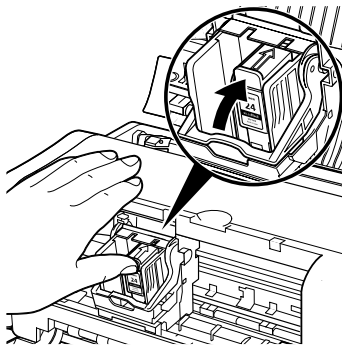
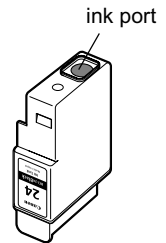

- 3** Insert the black ink tank into the right-hand slot.
- 4** Press the tab until it clicks into place.

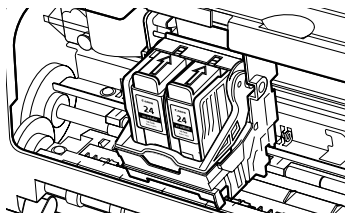

- 5** Use the same procedure to install the color ink tank in the left-hand slot.
- 6** Close the Front Cover.

Wait until the POWER lamp remains fully lit (about 60 seconds).

4 Loading Paper

■ Loading A4 (Letter) Size Plain Paper

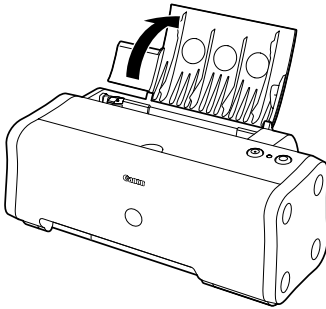

1 Open the Paper Support as shown.

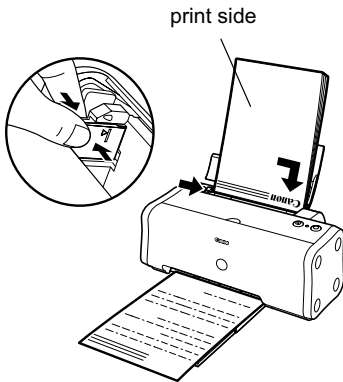

2 Load the paper, aligning it with the right side of the Auto Sheet Feeder.

You can load a maximum of 100 sheets of plain paper (64 gsm). Do not exceed this limit.

3 Pinch the Paper Guide and slide it against the left side of the stack of paper.

You now need to install the printer driver:

Windows: Go to page 8

Mac OS X: Go to page 11

5 Installing the Printer Driver

■ Installing the Printer Driver – Windows

→ Notes

- Do not disconnect the cable or remove the CD-ROM during the installation. The driver cannot be correctly installed.
- The screens below refer to Windows XP installation. Screen may differ depending on the operating system you are using.
- When installing the printer driver in Windows XP, Windows 2000, log on to the system as a member of the **Administrators** group.

If the following screen appears automatically, click **Cancel** and follow steps 1 to 9 to install the printer driver.



Special Notes for Windows Me or Windows 98 USB Users

Click **Cancel** to quit the screen and turn off the printer. Next, remove and replace the USB cable connected to your computer.

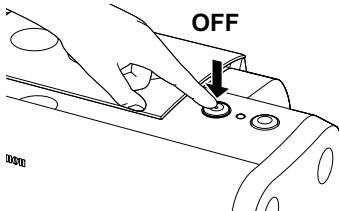

- 1** Ensure that the printer and computer are turned off.
- 2** Turn on the computer and start Windows. If any applications automatically run, quit them.
Disable any virus detection programs.
Do NOT turn the printer on at this stage.

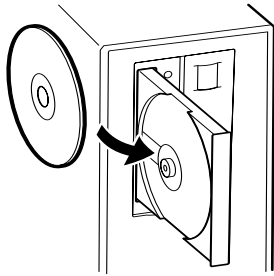

3 Place the *Setup Software & User's Guide CD-ROM* in the CD-ROM drive.

→ **Notes**

- If the CD-ROM does not run automatically, click **Start** and select **My Computer**, then double-click the CD-ROM icon. For non-Windows XP, double-click **My Computer** in the Windows screen, then double-click the CD-ROM icon.
- If the language selection screen appears, select a language, then click **Next**.
- If the place selection message appears, select your place of residence, then click **Next**.

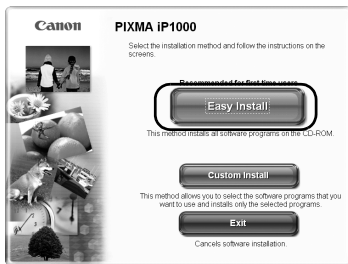

4 Follow the instructions displayed on screen. When the screen shown on the left is displayed, click **Easy Install**.

→ **Note**

When you select **Easy Install**, all the items included in the CD-ROM are installed automatically.

To select particular items to install, click **Custom Install** and follow the instruction on the screen.

5 When the list of applications to install appears, verify the contents, click **Install**, then follow the instructions on the screen.

6 Read the License Agreement and click **Yes**.

7 When the screen shown on the left appears, turn the printer on.

If the printer is recognized, the printer driver will be automatically installed.

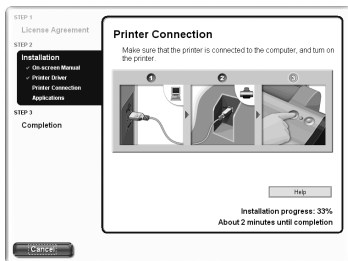

→ **Note**

If the connection is not recognized, refer to the section “Notes on Handling the USB Interface (for Windows Users)” on page 19.

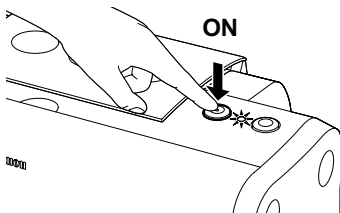



8 Click **OK**.

Some screens appear after clicking **OK**. Read the content shown on the screens and click **Next**.



9 When the screen shown on the left appears, click **Exit**.

You can restart the system by clicking **Restart**, which will appear when you check the check box.

If ruled lines are displaced or the print result is unsatisfactory, align the Print Head.

Refer to “Aligning Print Head” in the *User’s Guide*.

→ **Notes**

- To view the *User’s Guide*, double-click the **User’s Guide** short-cut icon on the desk top.
 - For further information of applications and how to start them, refer to “Applications Included in the CD-ROM Package” on page 20.
-

■ Installing the Printer Driver – Macintosh

→ Notes

- Do not remove or insert the USB cable during installation, as this may result in the computer or printer not operating normally.
- Before installing the driver, disable all virus detection programs and automatically loading programs or remove them from your system folder.
- The *Setup Software & User's Guide CD-ROM* contains the application software, Easy-PhotoPrint, to import and print image data. If you want to install Easy-PhotoPrint, double-click the application folder, then double-click the Easy-PhotoPrint folder, and **Installer**.
- For Mac OS 9.x users, refer to the *Printer Driver Guide for Mac OS 9* for instructions on how to install the printer driver. To view the *Printer Driver Guide for Mac OS 9*, double-click the **Manual** folder and **Additional Guide for OS 9 Users** folder and select a language folder.

- 1 Turn on the Mac.
- 2 Place the *Setup Software & User's Guide CD-ROM* in the CD-ROM drive.
- 3 Double-click the **Mac OS X** folder, and then double-click the **Printer Driver** folder.

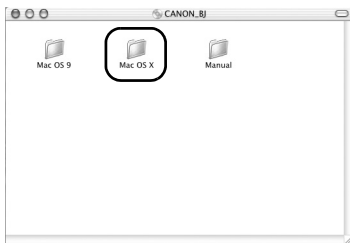

- 4 Double-click **PIXMA iP1000 270.pkg**.
- 5 Click **Continue**.

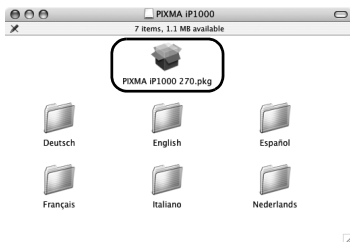

- 6 Read the License Agreement and click **Continue**, then click **Agree**.

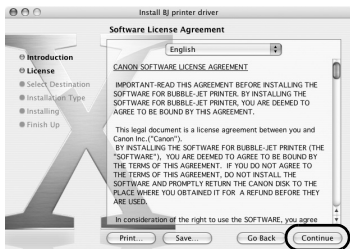

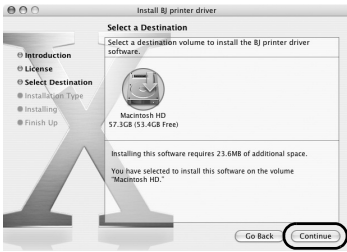

- 7 Select a destination to where you want to install the printer driver, and click **Continue**.

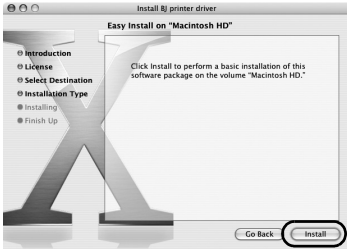

- 8 Click **Install**.

- 9 Enter an administrator name and a password, then click **OK**.

➔ **Note**

When you have forgotten the administrator name and/or password, click  and follow the instructions in **Mac Help**.

- 10 A message asking for your confirmation to restart your computer is displayed on the screen. Read the message, then click **Continue Installation**.

Software installation will start.

- 11 Software installation is complete. Restart your computer.

If ruled lines are displaced or the print result is unsatisfactory, align the Print Head.

Refer to “Aligning Print Head” in the *User's Guide*.



Basic Operations

⚠ Caution

- If you detect smoke, unusual smells or strange noises around the printer, immediately switch the printer off and always unplug the printer. Contact your local Canon service representative.
- To avoid injury, never put your hand or fingers inside the printer while it is printing.

Printing with Windows

Adjusting the print settings according to your needs allows you to produce better quality prints. In this section, we will use NotePad for the purpose of explanation. The procedures and the screens that appear on your computer may differ according to the application that you use.

■ Printing

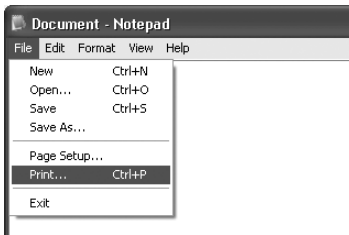

1 Print the document from the application.

On the **File** menu, click **Print**.

Check the application's user's manual for the actual procedures.

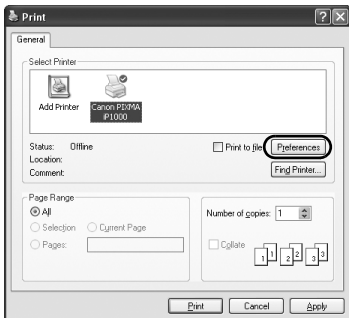

2 Ensure that your printer is selected, then click:

- Windows XP → **Preferences**
- Windows Me/Windows 98 → **Properties**
- Windows 2000 → **Main** tab

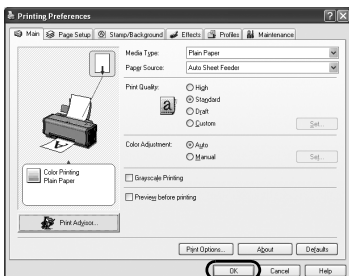

3 Specify the required settings and click **OK**.

➔ **Note**

If you use anything other than plain paper, please refer to "Basic Print Settings" on page 14.

4 To start printing, click **OK**.

Printing will start in a few moments.

■ Basic Print Settings

For the best print quality, specify the minimum requirement settings in the **Main** tab. To get the best results, ensure that you select the type of media loaded in the printer when printing on paper other than plain paper.

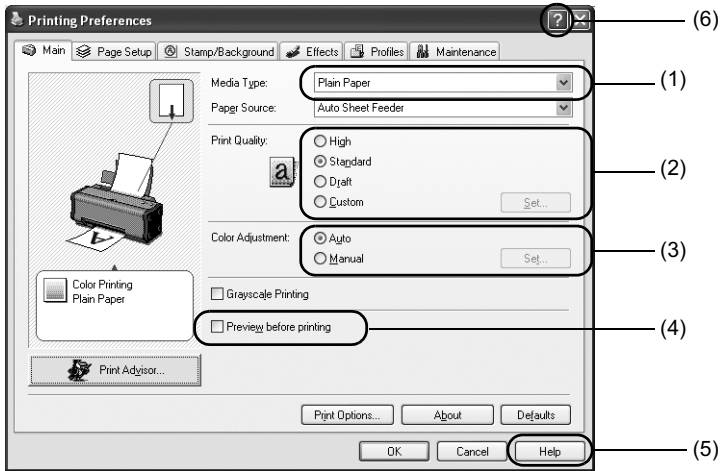

(1) Media Type	Select the media loaded in the printer.
(2) Print Quality	Select one option from High , Standard and Draft . Select Custom to set the print quality manually.
(3) Color Adjustment	If you wish to control the color adjustment settings in more detail, select Manual .
(4) Preview before printing	Select this to check the layout before printing.
(5) Help	Click this for a more detailed explanation of the functions in the tab. (This may not appear in Windows XP or Windows 2000. If this happens, click Start and select All Programs (or Programs), Canon PIXMA iP1000 and Guide).
(6) ?	Click this to change the cursor shape to "?". By clicking on the item's name with this ? cursor, an explanation will be displayed.

➔ Notes

- Clicking the **Print Advisor** allows you to change to the most appropriate print settings simply by answering questions when prompted.
- Use the application to set the paper size and paper orientation. Before printing, open the settings screen and check that the **Page Size** in the **Page Setup** tab is the same as that specified within application.
- Refer to the *User's Guide* for more information about printer driver functionality.

Printing with Macintosh

Adjusting the print settings according to your needs allows you to produce better quality prints.

■ Printing

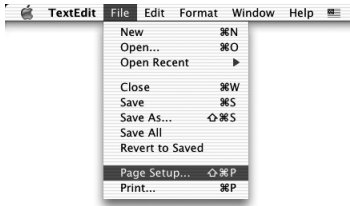

- 1 Open the **Page Setup** dialog box in your application.

On the **File** menu, click **Page Setup**. Check the application's user's manual for the actual procedures.

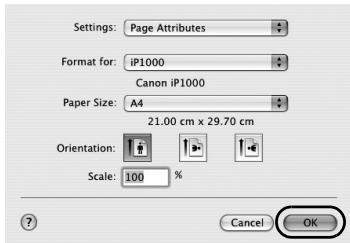

- 2 Specify the page setup, then click **OK**.

For details, refer to “Page Setup” on page 16.

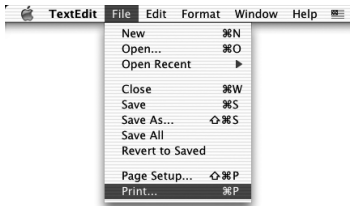

- 3 Open the **Print** dialog box in your application to print the document.

On the **File** menu, click **Print**. Check the application's user's manual for the actual procedures.

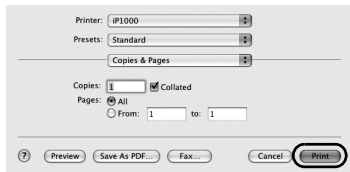

- 4 Specify the print settings according to your requirements.

For details, refer to “Basic Print Settings” on page 16.

- 5 Click **Print**.

Printing will start in a few moments.

■ Page Setup

Use the **Page Setup** dialog box to specify the **Paper Size** settings.

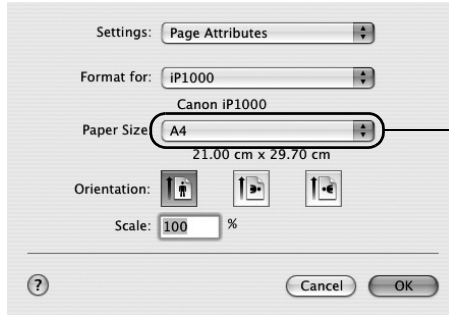

Select paper size you wish to use.

■ Basic Print Settings

For the best print quality, specify the minimum requirement settings in the **Print** dialog box. Select **Quality & Media** from the pop-up menu to change the display of the dialog box. To get the best results, ensure that you select the media loaded in the printer when printing on paper other than plain paper.

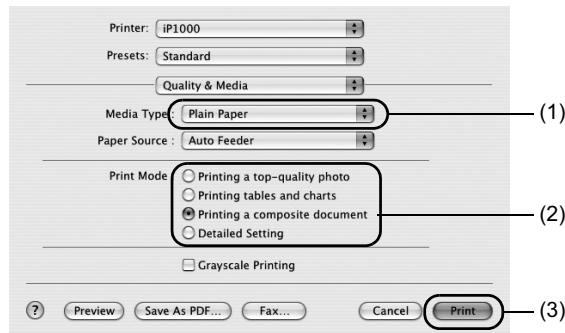

(1) Media Type	Select the media loaded in the printer.
(2) Print Mode	Select the type of document you want to print. To specify more detailed settings for the print quality, click Detailed Setting .
(3) Print	Click this to start printing.

➔ Notes

- See Help for more information about other printer driver functions.
Click  in the **Page Setup** dialog box or the **Print** dialog box.
- Refer to the *User's Guide* for more information about printer driver functions.

■ If Blurring Occurs or If a Specific Color Does Not Print

Perform print head cleaning to improve the print quality. Ensure that the printer is turned on and follow the instructions below.

Windows

Open the printer driver settings screen and click the **Maintenance** tab. Click **Cleaning**.

- (1) Click **Start** and select **Control Panel, Printers and Other Hardware** and **Printers and Faxes** (For non-Windows XP users, click **Start**, and then select **Settings and Printers**).
- (2) Click the icon for your printer.
- (3) Open the **File** menu and select:
In Windows XP or Windows 2000 → **Printing Preferences**
In Windows Me or Windows 98 → **Properties**
to open the setting screen.

Macintosh

Open the **BJ Printer Utility**, and select **Cleaning** from the pop-up menu. Click **Cleaning**.

- (1) Double-click the hard disk icon where the printer driver was installed, the **Applications** folder, and the **Utilities** folder.
- (2) Double-click the **Printer Setup Utility** icon.
If you are using the OS other than Mac OS X v.10.3, double-click the **Print Center** icon.
- (3) Select **iP1000** from the **Name** list and click **Utility** or **Configure**.
- (4) Select **iP1000** from the **Product** list and click **Maintenance**.
to open the **BJ Printer Utility** dialog box.

■ When the Printer Runs out of Ink

Replace the empty ink tank with a new one.
Specify the following ink tanks when purchasing.

Ink Tank BCI-24 Color
Ink Tank BCI-24 Black

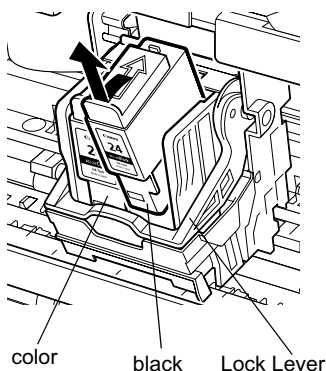

- 1** Open the Front Cover and remove the empty ink tank.

Do not touch the Lock Lever.

2 Install the new ink tank.

Close the Front Cover when finished.

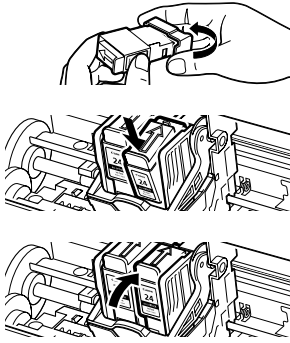

↳ **Note**

When you enable the low ink warning, reset the ink counter of the ink tank installed.

Refer to the *User's Guide* for more detailed procedures and information about maintenance.

Appendix

Notes on Handling the USB Interface (for Windows Users)

If installation of the printer driver does not proceed as instructed in this *Quick Start Guide*, there may be a problem with the USB driver installation.

Try reinstalling the printer driver.

■ Reinstalling

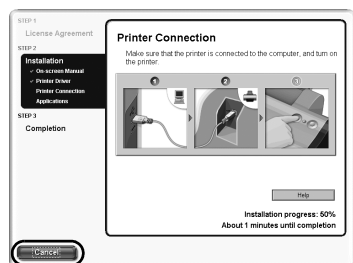

If you cannot proceed beyond the **Printer Connection** screen;

- 1 Click **Cancel** on the **Printer Connection** screen.
- 2 Click **Cancel** on the **Printer Connection** screen. Click **Start Over** on the **Installation Failure** screen.
- 3 Click **Back** on the **Easy Install** screen.
- 4 Click **Exit** on the **Welcome** screen, then remove the CD-ROM.
- 5 Turn the printer off.
- 6 Restart the computer.
- 7 Reinstall the printer driver (see page 8).

For Further Details...

For more information, refer to the *User's Guide*. The *User's Guide* is an HTML manual you can browse through on your computer.

■ User's Guide Contents

The *User's Guide* is HTML manual you can browse through on your computer.

- Printer parts and their function
- Further printing techniques
- Routine maintenance
- Printing media
- Troubleshooting
- Specifications

■ How to View the User's Guide

For Windows

Double-click the **User's Guide** short-cut icon on the desk top, or click **Start** and select **All Programs** (or **Programs**), **Canon PIXMA iP1000** and **User's Guide**.

For Mac OS X

- (1) Load the CD-ROM in your computer.
- (2) Double-click the **Manual** folder.
- (3) Double-click the **User's Guide** folder.
- (4) Select a language folder.
- (5) Double-click the icon for the **iP1000_UG_ENG.htm** file.

■ Applications Included in the CD-ROM Package

Easy-PhotoPrint (Windows/Macintosh)

You can make a Borderless Print easily and quickly, just by selecting a photograph taken with a digital camera and the paper type on which to print. Also it has tools to correct red eye caused by the camera's flash or smooth and beautify the facial skin. It is compatible with Exif Print.

PhotoRecord (Windows)

You can create fun and unique photo albums with a click of your mouse. It is compatible with Exif Print. For more information on the applications, refer to the *Photo Application Guide*.

■ BJ Printer Driver Systems Requirements

For Windows

- Use a computer equipped on which Windows XP, Windows 2000, Windows Me, or Windows 98 can operate.
- USB* interface
- CD-ROM drive
- Available hard-disk space for printer driver installation (including temporary files)
Windows XP/Windows 2000: 50MB
Windows Me/Windows 98: 15MB

*USB operation can only be guaranteed on a PC with pre-installed Windows XP, Windows 2000, Windows Me, or Windows 98.

For Macintosh

- Use a Macintosh series computer equipped with USB interface on which Mac OS X v.10.2.1 or later or Mac OS 9.x can operate.
- USB interface
- CD-ROM drive
- Available hard-disk space for printer driver installation
Mac OS X v.10.2.1 or later: 100 MB
Mac OS 9.x: 30 MB
- The following functions are not supported when using Mac OS X v.10.2.1 or later:
 - Duplex Printing
 - Poster Printing
 - Fit to Page Printing
 - Booklet Printing
 - Reverse Order Printing (except for Mac OS X v.10.3.x)
 - Photo Optimizer Pro

Additional Systems Requirements for Electric Manual

- 15 MB free hard disk space
- Windows: Microsoft® Internet Explorer 5.0 or later.
- Mac OS: Microsoft® Internet Explorer 5.0 or later, Safari 1.0 or later.

Regulatory Information

For 220-240V, 50/60Hz model

This device complies with Part 15 of the FCC Rules. Operation is subject to the following two conditions: (1) This device may not cause harmful interference, and (2) this device must accept any interference received, including interference that may cause undesired operation.

Note: This equipment has been tested and found to comply with the limits for a Class A digital device, pursuant to Part 15 of the FCC Rules. These limits are designed to provide reasonable protection against harmful interference when the equipment is operated in a commercial environment. This equipment generates, uses, and can radiate radio frequency energy and, if not installed and used in accordance with the instruction manual, may cause harmful interference to radio communications. Operation of this equipment in a residential area is likely to cause harmful interference in which case the user will be required to correct the interference at his own expense.

Do not make any changes or modifications to the equipment unless otherwise specified in the manual. If such changes or modifications should be made, you could be required to stop operation of the equipment.

For 110-120V, 50/60Hz model

Color Printer Model: K10241

This device complies with Part 15 of the FCC Rules. Operation is subject to the following two conditions: (1) This device may not cause harmful interference, and (2) this device must accept any interference received, including interference that may cause undesired operation.

Note: This equipment has been tested and found to comply with the limits for a Class B digital device, pursuant to Part 15 of the FCC Rules. These limits are designed to provide reasonable protection against harmful interference in a residential installation. This equipment generates, uses and can radiate radio frequency energy and, if not installed and used in accordance with the instructions, may cause harmful interference to radio communications.

However, there is no guarantee that interference will not occur in a particular installation. If this equipment does cause harmful interference to radio or television reception, which can be determined by turning the equipment off and on, the user is encouraged to try to correct the interference by one or more of the following measures:

- Reorient or relocate the receiving antenna.
- Increase the separation between the equipment and receiver.
- Connect the equipment into an outlet on a circuit different from that to which the receiver is connected.
- Consult the dealer or an experienced radio/TV technician for help.

Use of a shielded cable is required to comply with Class B limits in Subpart B of Part 15 of the FCC Rules.

Do not make any changes or modifications to the equipment unless otherwise specified in the manual. If such changes or modifications should be made, you could be required to stop operation of the equipment.

Canon U.S.A., Inc.
One Canon Plaza
Lake Success, NY 11042
1-516-328-5600

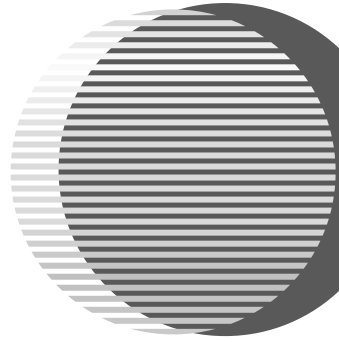

The following ink tanks are compatible with this printer.
For details on ink tank replacement, refer to “Print Head Maintenance” in this guide.



BCI-24 Black



BCI-24 Color