





marantz[®] 8 Channel Power Amplifier
MM8003

User Guide



CAUTION
RISK OF ELECTRIC SHOCK
DO NOT OPEN



**CAUTION: TO REDUCE THE RISK OF ELECTRIC SHOCK,
 DO NOT REMOVE COVER (OR BACK)
 NO USER-SERVICEABLE PARTS INSIDE
 REFER SERVICING TO QUALIFIED SERVICE PERSONNEL**

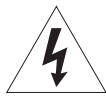

The lightning flash with arrowhead symbol within an equilateral triangle is intended to alert the user to the presence of uninsulated "dangerous voltage" within the product's enclosure that may be of sufficient magnitude to constitute a risk of electric shock to persons.



The exclamation point within an equilateral triangle is intended to alert the user to the presence of important operating and maintenance (servicing) instructions in the literature accompanying the product.

WARNING

TO REDUCE THE RISK OF FIRE OR ELECTRIC SHOCK, DO NOT EXPOSE THIS APPLIANCE TO RAIN OR MOISTURE.

CAUTION: TO PREVENT ELECTRIC SHOCK, MATCH WIDE BLADE OF PLUG TO WIDE SLOT, FULLY INSERT.

ATTENTION: POUR EVITER LES CHOCS ELECTRIQUES, INTRODUIRE LA LAME LA PLUS LARGE DE LA FICHE DANS LA BORNE CORRESPONDANTE DE LA PRISE ET POUSSER JUSQU'AU FOND.

NOTE:

This equipment has been tested and found to comply with the limits for a Class B digital device, pursuant to Part 15 of the FCC Rules. These limits are designed to provide reasonable protection against harmful interference in a residential installation. This equipment generates, uses and can radiate radio frequency energy and, if not installed and used in accordance with the instructions, may cause harmful interference to radio communications. However, there is no guarantee that interference will not occur in a particular installation. If this equipment does cause harmful interference to radio or television reception, which can be determined by turning the equipment off and on, the user is encouraged to try to correct the interference by one or more of the following measures:

- Reorient or relocate the receiving antenna.
- Increase the separation between the equipment and receiver.
- Connect the equipment into an outlet on a circuit different from that to which the receiver is connected.
- Consult the dealer or an experienced radio/TV technician for help.

NOTE:

Changes or modifications may cause this unit to fail to comply with Part 15 of the FCC Rules and may void the user's authority to operate the equipment.

This Class B digital apparatus complies with Canadian ICES-003.

Cet appareil numérique de la Classe B est conforme à la norme NMB-003 du Canada.

IMPORTANT SAFETY INSTRUCTIONS

READ BEFORE OPERATING EQUIPMENT

This product was designed and manufactured to meet strict quality and safety standards. There are, however, some installation and operation precautions which you should be particularly aware of.

1. Read these instructions.
2. Keep these instructions.
3. Heed all warnings.
4. Follow all instructions.
5. Do not use this apparatus near water.
6. Clean only with dry cloth.
7. Do not block any ventilation openings. Install in accordance with the manufacturer's instructions.
8. Do not install near any heat sources such as radiators, heat registers, stoves, or other apparatus (including amplifiers) that produce heat.
9. Do not defeat the safety purpose of the polarized or grounding-type plug. A polarized plug has two blades with one wider than the other. A grounding type plug has two blades and a third grounding prong. The wide blade or the third prong are provided for your safety. If the provided plug does not fit into your outlet, consult an electrician for replacement of the obsolete outlet.



10. Protect the power cord from being walked on or pinched particularly at plugs, convenience receptacles, and the point where they exit from the apparatus.
11. Only use attachments/accessories specified by the manufacturer.
12. Use only with the cart, stand, tripod, bracket, or table specified by the manufacturer, or sold with the apparatus. When a cart is used, use caution when moving the cart/apparatus combination to avoid injury from tip-over.
13. Unplug this apparatus during lightning storms or when unused for long periods of time.

14. Refer all servicing to qualified service personnel. Servicing is required when the apparatus has been damaged in any way, such as power-supply cord or plug is damaged, liquid has been spilled or objects have fallen into the apparatus, the apparatus has been exposed to rain or moisture, does not operate normally, or has been dropped.

Additional Safety Information!

- This product should not be placed in a built-in installation such as a bookcase or rack unless proper ventilation is provided or the manufacturer's instructions have been adhered to.
- Apparatus shall not be exposed to dripping or splashing and that no objects filled with liquids, such as vases, shall be placed on the apparatus.
- When the switch is in the OFF position, the apparatus isn't completely switched-off from the MAINS.
- The equipment shall be installed near the power supply so that the power supply is easily accessible.
- Do not touch hot spots during and immediately after use.
- During and immediately after use, this product is hot in areas other than the controls and rear panel connection jacks.
- Do not touch hot spots and especially the top panel. Contact with hot areas can cause burns.
- Do not be exposed to excessive heat such as sunshine, fire or the like.

DECLARATION OF CONFORMITY

This device complies with Part 15 of the FCC rules. Operation is subject to the following conditions: (1) This device may not cause harmful interference, and (2) this device must accept any interference received, including interference that may cause undesired operation.

U.S. Responsible Party: Marantz America, Inc.
100 Corporate Drive,
Mahwah, NJ, 07430, U.S.A.
TEL: 201-762-6500

Type of Product: 8 Channel Power Amplifier
 Model: MM8003

INTRODUCTION

Thank you very much for purchasing this model MM8003 8-Channel Power Amplifier from Marantz. This remarkable component has been engineered to provide you with many years of home theater enjoyment. Please take a few minutes to read this manual thoroughly before you connect and operate the MM8003. As there are a number of connection and configuration options, you are encouraged to discuss your own particular home theater setup with your Marantz A/V specialist dealer.

ACCESSORIES CHECK

Before use, check the below accessories were included in the package.

AC power cable

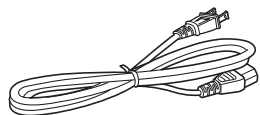

Remote control cable

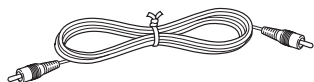

User Guide

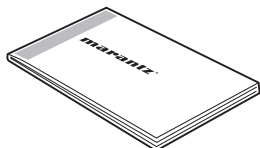

Warranty Card

USA × 1
Canada × 1

CONTENTS

INTRODUCTION	1	OPERATION	8
ACCESSORIES CHECK	1	TURNING ON THE POWER	8
CONTENTS	1	TURNING THE POWER OFF	8
FEATURES	2	ADVANCED CONNECTIONS	9
BEFORE USE	2	BI-AMPLIFIER CONNECTIONS	9
NAMES AND FUNCTION	3	MULTI ZONE SPEAKER CONNECTIONS	10
FRONT PANEL	3	MULTI ZONE CONNECTIONS	11
REAR PANEL	3	REMOTE CONTROL CONNECTIONS	12
BASIC CONNECTIONS	4	CONNECTIONS WITH EXTERNAL CONTROL	
PREPARING THE CONNECTION CABLES	4	COMPONENTS	12
INPUT CONNECTOR SWITCHING	4	TROUBLESHOOTING	13
AV8003 CONNECTIONS	5	RESETTING THE AMPLIFIER	13
SPEAKER CONNECTIONS	6	OTHERS	14
POWER CABLE CONNECTION	7	SPECIFICATIONS	14
USING AC OUTLETS	7		

FEATURES

This 8-channel power amplifier comes with upgraded functions and supports the latest format of surround sound without compromising the design technology of Marantz's flagship models.

Current feedback type of discrete power amplifier with high sound quality

The MM8003 features in all 8 channels the current feedback type of power amplifier, which uses the complementary push-pull circuitry incorporated in Marantz's SM-11S1 Hi-Fi Power Amplifier. This improves the model's operating stability and enables it to achieve high-density, high-speed sound reproduction across a wide sound range.

In the rear section the power amplifier is a current/voltage conversion amplifier unit that employs a Wilson current mirror circuit for amplifying sound up to the treble range at low distortion levels.

Improved instantaneous current supply capability

In the rear section of the power amplifier is the LAPT (high-performance power transistor), which is featured in Marantz's model SM-11S1 Hi-Fi Power Amplifier. This device improves the instantaneous current supply capability.

Copper bus bars are featured in the unit that supplies the power to each channel.

The power supply unit has a large toroidal transformer that delivers low levels of noise and leakage flux thanks to its internal structural features such as its laminated core, silicon steel-plated core ring, etc., and the use of its shielded casing.

Original Marantz parts with a combined capacitance of 100,000 μF (50,000 μF /71V \times 2), which have been specially crafted to achieve the maximum in terms of sound quality, are employed in the block capacitor, a key component of the power supply unit.

Thanks to the improvements in the current supply capability of these parts, you can enjoy high-powered sound brimming with ambiance.

High-sound-quality design based on the pure surround concept

A chimney-type heat sink and extremely quiet cooling fan deal with the heat that is discharged from the 8-channel amplifier to a high degree of efficiency. A high-precision temperature sensor IC is used to adjust the rotational speed of the cooling fan in response to the changes in the amount of heat generated by the amplifier.

These features together make for lavish specifications well suited to the amplifier's use in high-end theater systems, which are engineered to ensure virtually noiseless operation.

The amplifier's chassis is copper-plated to protect the analog audio circuitry from high-frequency noise. This is an important technological aspect for reproducing sound without compromising the delicately nuanced sound fields of Super Audio.

In addition, top-of-the-line audio capacitors, film capacitors and other high-quality components are used to achieve a high-sound-quality design.

BALANCED/UNBALANCED switching function

This function makes it possible to select BALANCED or UNBALANCED input each channel depending on the application.

Remote power control

By connecting the amplifier to Marantz's model AV8003 AV pre-tuner, the amplifier's power can be switched on or off in tandem with the power on/off operation of the AV8003 using the remote power control function.

A floating ground connection that doesn't form a ground loop is used for the connection with the AV8003 so the sound quality is not adversely affected.

Other functions

Also provided are an IR flasher input connector to support customized installation, and DC trigger input connector and output connectors.

BEFORE USE

This section must be read before any connection is made to the mains supply.

EQUIPMENT MAINS WORKING SETTING

Your Marantz product has been prepared to comply with the household power and safety requirements that exist in your area.

MM8003 can be powered by 120V AC only.

COPYRIGHT

Recording and playback of any material may require consent. For further information refer to the following:

- Copyright Act 1956
- Dramatic and Musical Performers Act 1958
- Performers Protection Acts 1963 and 1972
- Any subsequent statutory enactments and orders

DO NOT LOCATE IN THE FOLLOWING PLACES

To ensure long-lasting use, do not locate the unit where:

- Exposed to direct sunlight.
- Near to sources of heat such as heaters.
- Highly humid or poorly ventilated.
- Dusty.
- Subjected to mechanical vibrations.
- On wobbly, inclined or otherwise unstable surfaces
- Radiated heat is blocked such as in cramped audio racks.

To ensure proper heat radiation, ensure the below clearance from walls and other equipment.

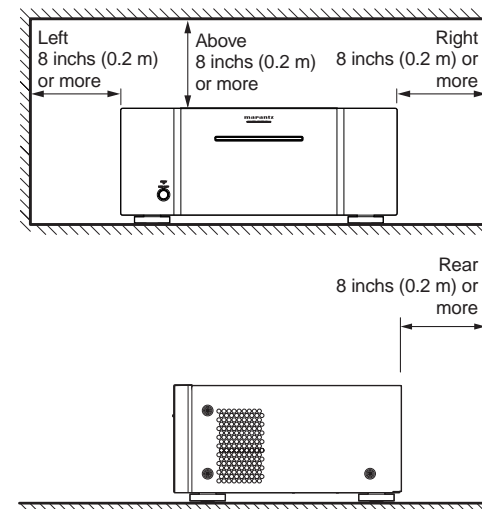

KEEP OBJECTS OFF

Keep objects off the unit. Blocking the vent can result in accident and damage.

DO NOT TOUCH HOT SPOTS DURING AND IMMEDIATELY AFTER USE

During and immediately after use, the unit is hot in areas other than the controls and rear panel connection jacks. Do not touch hot spots and especially the top panel. Contact with hot areas can cause burns.

NAMES AND FUNCTION

For a more detailed description of the functions of each part, refer to the pages given in ().

FRONT PANEL

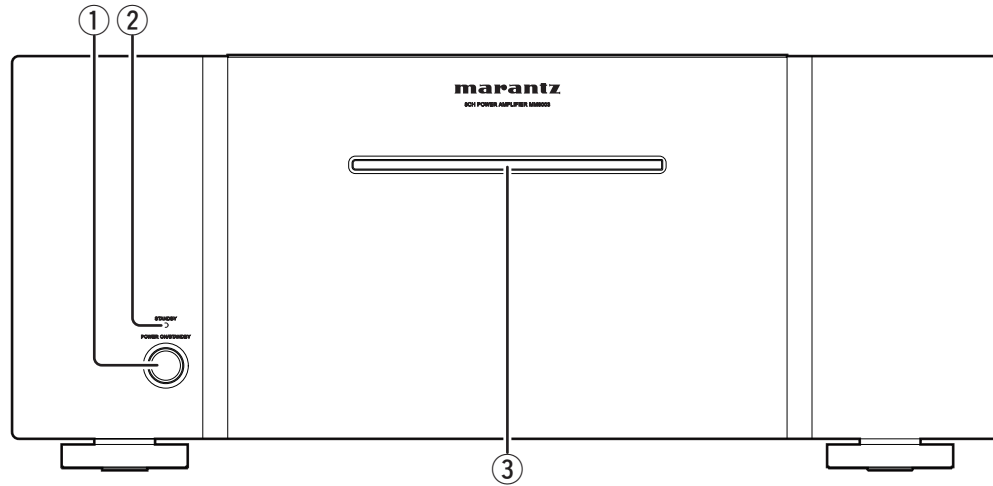

- ① POWER ON/STANDBY button (page 8)
- ② STANDBY indicator (page 8)
- ③ Illumination lamp (page 8)

REAR PANEL

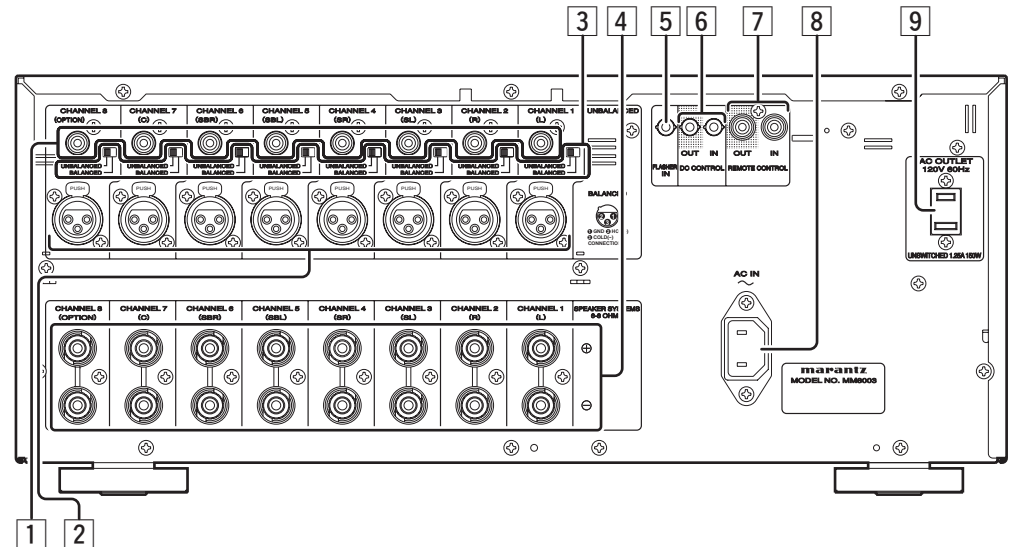

- ① UNBALANCED (RCA) input connectors (page 5)
- ② BALANCED (XLR) input connectors (page 5)
- ③ Input selector switches (page 4)
- ④ SPEAKER SYSTEMS output connectors (page 6)
- ⑤ Flasher input connector (page 12)
- ⑥ DC CONTROL IN/OUT connectors (page 12)
- ⑦ REMOTE CONTROL IN, OUT connectors (page 12)
- ⑧ AC IN socket (page 7)
- ⑨ AC OUTLET (page 7)

BASIC CONNECTIONS

PREPARING THE CONNECTION CABLES

Provide the cables required by the component to be used.

BALANCED CONNECTIONS

XLR audio cable



① This amplifier uses XLR connectors, which are widely used in professional audio applications, for the BALANCED connectors. Their features are described below.

- Due to their 3-pin construction, the music signals can be transmitted as balanced signals, and the effects of extraneous noise are minimal.
- Their connect/disconnect locking mechanism minimizes any shakiness in the connector area and performs high reliability.

② For professional audio applications, the XLR connectors can be connected in the following two ways.

1. European system (pin ② = hot, pin ③ = cold)

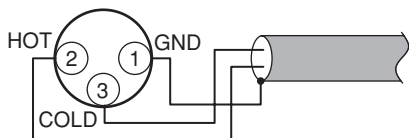

2. U.S. system (pin ② = cold, pin ③ = hot)

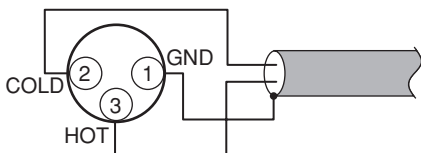

③ The XLR connectors on this amplifier use the European system in 1. above. If a pre-amplifier or control amplifier with connectors using the U.S. system is connected to this amplifier using balanced cables, the signal phase will be reversed.

To correct the signal phase, reverse the connections of pins ② and ③ of the XLR connector at one end of the cable.

UNBALANCED CONNECTIONS

RCA audio cable



REMOTE CONTROL CONNECTIONS

RCA cable (accessory)

(This cable is required to connect the AV8003 or other Marantz component to this amplifier.)



SPEAKER CONNECTIONS

Speaker cable

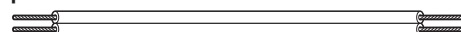

INPUT CONNECTOR SWITCHING

A BALANCED or UNBALANCED input for the input connectors can be selected for each channel.

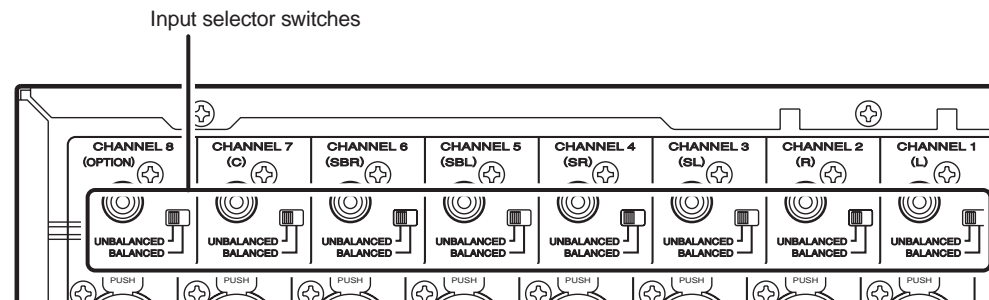

BALANCED:

The XLR audio cable is used for connection with the control amplifier.

UNBALANCED:

The RCA audio cable is used for connection with the control amplifier.

Notes:

- Select the input, whether balanced or unbalanced, before turning on the power. Failure may occur if it is selected after the power has already been turned on.
- If the amplifier input and input selector switch settings are incorrectly matched, no sound will be output from the amplifier.

AV8003 CONNECTIONS

The connection example given below shows the connections between the amplifier and AV8003 AV pre-tuner for basic sound reproduction through 7 channels. When using the **BALANCED** inputs, use the XLR audio cables; when using the **UNBALANCED** inputs, use the RCA audio cables. Connect the **PRE OUT** connectors on the control amplifier to the input connectors on this amplifier. Use this connection example as a reference when a control amplifier other than the AV8003 is to be used.

Notes:

- Do not connect the power cables of this amplifier and other components to the AC outlet until all the connections have been completed.
- Insert the plugs on the connecting cables firmly into the connectors. Noise may be caused by improper connections.
- For details on the components connected to this amplifier, refer to the operating instructions of each component.

BALANCED CONNECTIONS

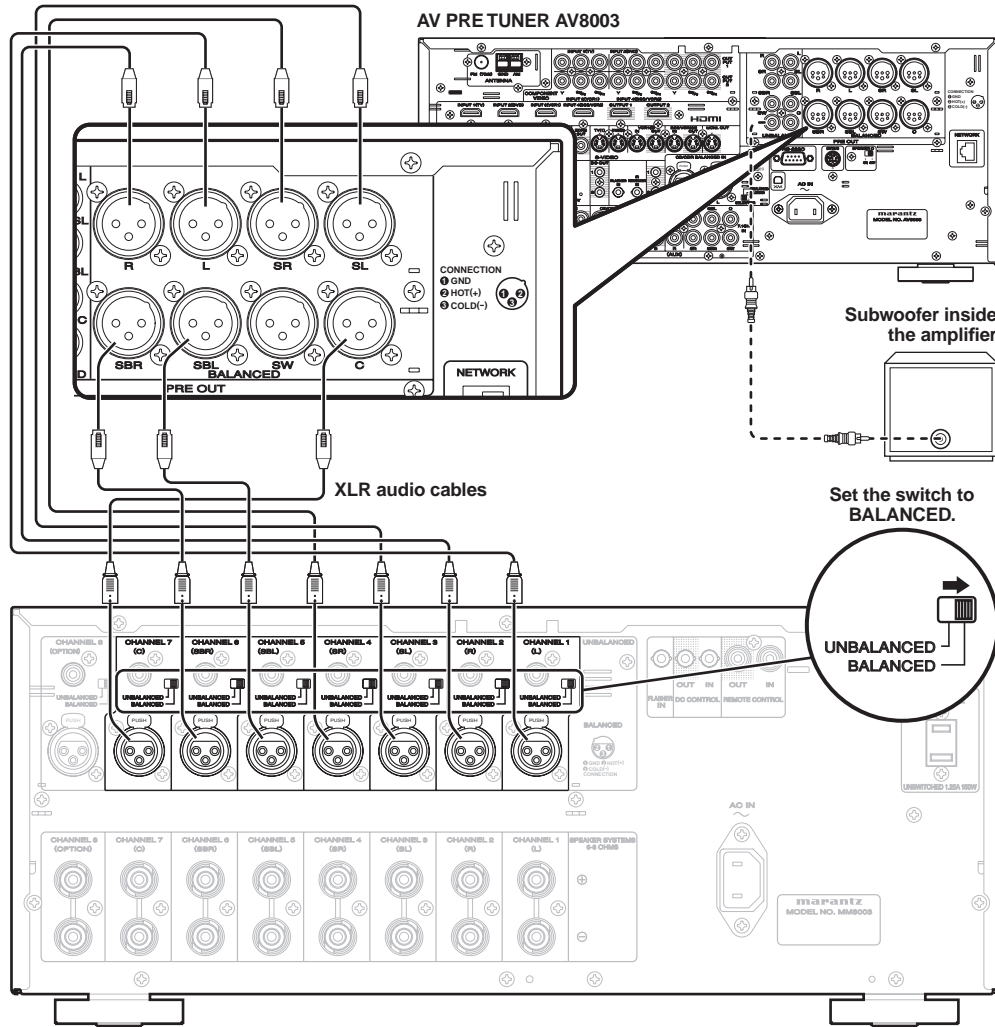

UNBALANCED CONNECTIONS

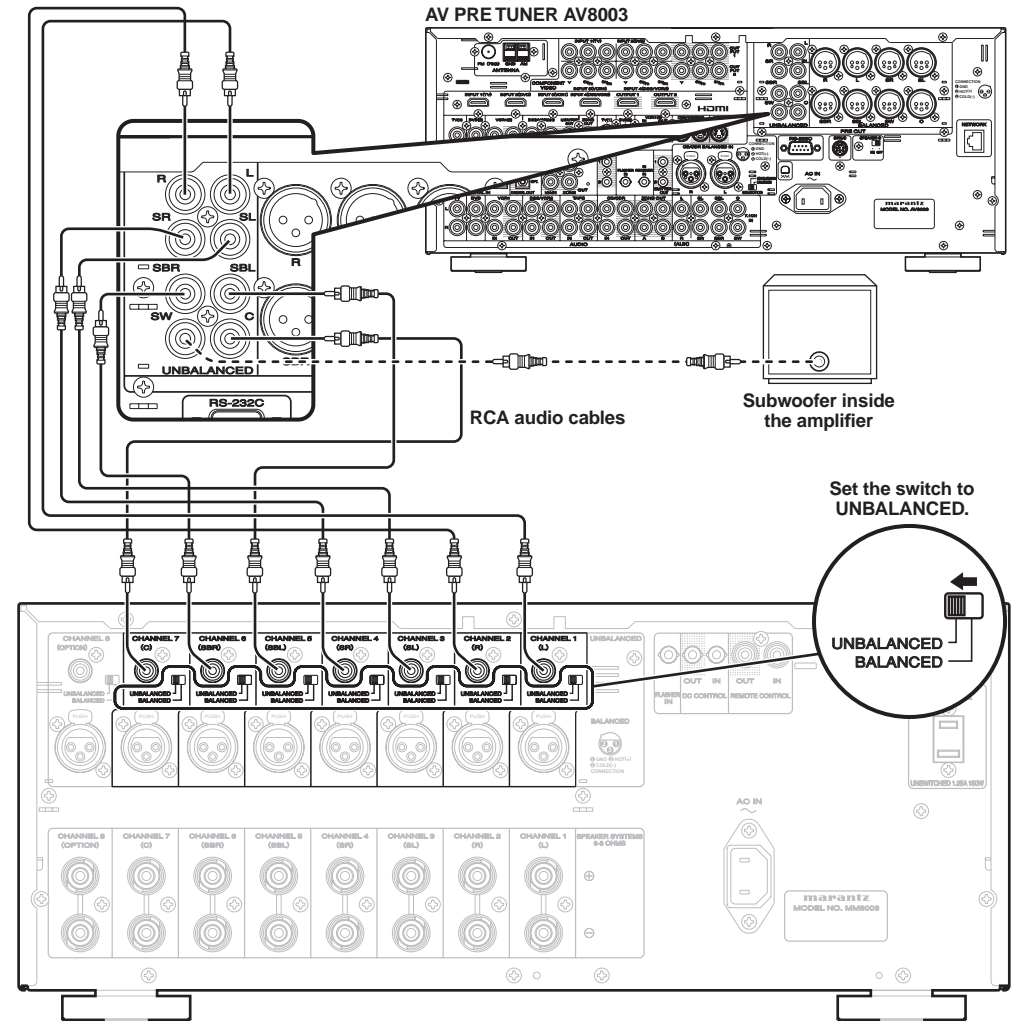

NAMES AND FUNCTION

BASIC CONNECTIONS

OPERATION

ADVANCED CONNECTIONS

TROUBLESHOOTING

OTHERS

SPEAKER CONNECTIONS

SPEAKER CONNECTIONS

Refer to the figure below, and connect the speakers to the amplifier.

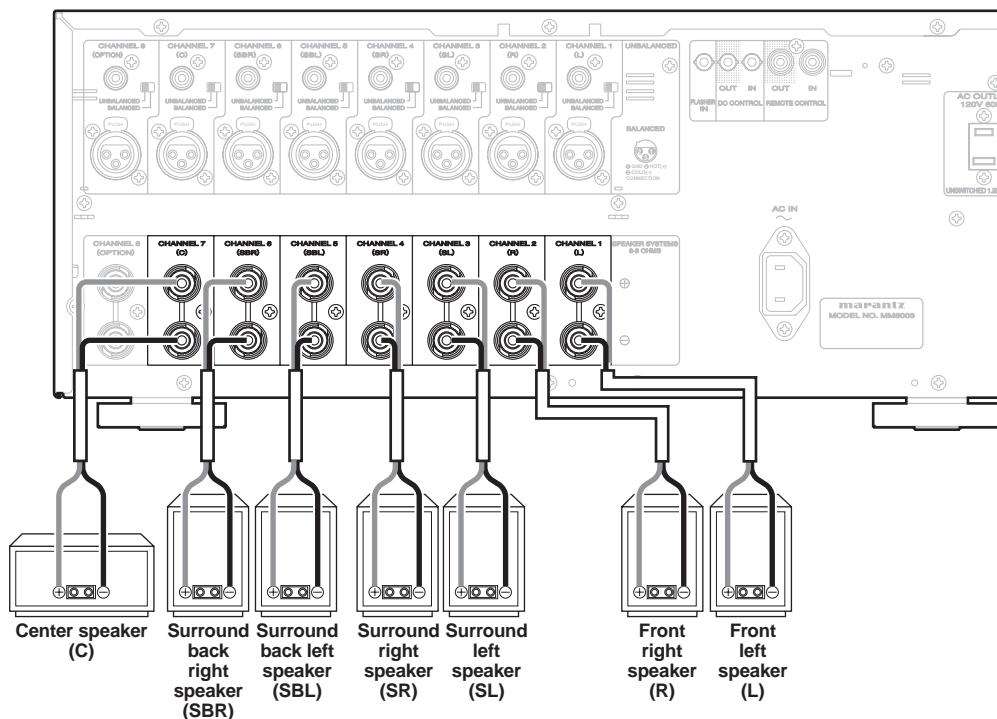

Notes:

- Speakers come with "+" and "-" terminals. When connecting the speakers to the amplifier, connect their "+" terminals to the "+" connectors on the amplifier and, similarly, connect their "-" terminals to the "-" connectors. If a "+" terminal is connected to a "-" connector, the signal phase will be reversed, and the music played through the speakers will sound unnatural. Refer to the operating instructions of the speakers, and properly reconnect the speakers.
- Connect speaker systems with an impedance of at least 6 Ω to the amplifier. If speakers with an impedance of under 6 Ω are used and sound is played at high volume levels for prolonged periods, the amplifier may experience an extreme rise in temperature, tripping the protection circuit.
- If the AV8003 AV pre-tuner is connected to the amplifier and one surround back speaker is to be used, connect the speaker to the surround back left channel (SBL).
If this is the case, the setting must be performed on the AV8003. (For details, refer to the operating instructions of the AV8003.) When using a control amplifier other than the AV8003, follow the operating instructions of the amplifier used, and connect the speaker properly.

SPEAKER CABLES

1. Remove about 10 mm of the covering from the end of the speaker cable.
2. Twist the bare part of the cable tightly to prevent short-circuiting.
3. Turn the speaker connector counterclockwise to loosen it.
4. Insert the bare part of the speaker cable into the hole at the side of the speaker connector.
5. Turn the speaker connector clockwise to tighten it up.

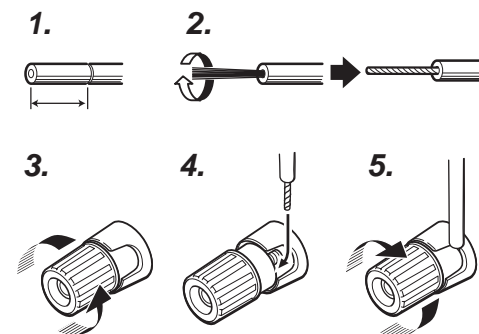

Notes:

- To protect the circuitry from damage, do not connect two bare speaker cables together or allow them to touch any metal parts of the amplifier.

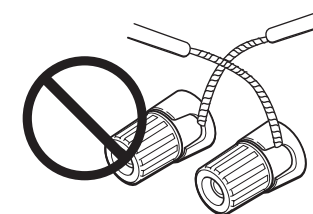

- Due to the risk of electric shock, do not touch the speaker connectors while the power is supplied.

TIPS ON SPEAKER PLACEMENT

How the speakers should be placed depends on the room size and other factors. An example of how the speakers are normally placed and some placement tips are given here.

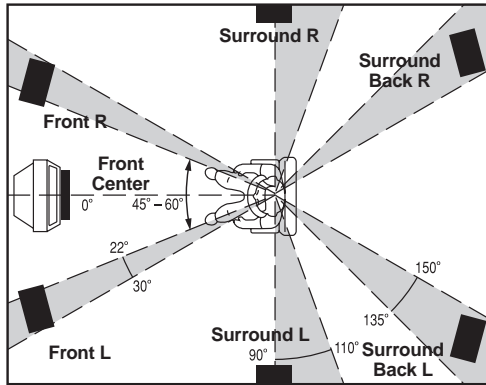

• Front left and right speakers

It is recommended that the front left and right speakers be positioned at an angle of 45 to 60 degrees from each other as viewed from the listening position.

• Center speaker

This speaker is placed so that its front panel is in line with the front panels of the front left and right speakers or slightly behind them.

Height at which to place the front left and right speakers and center speaker

Place the three front speakers (left, right and center) so that their mid-range and high-range units will be positioned at more or less the same height from the floor as much as possible.

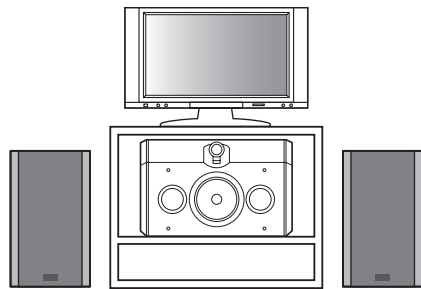

Note:

When placing speakers close to a TV set, use magnetically shielded speakers for the front left and right speakers and center speaker.

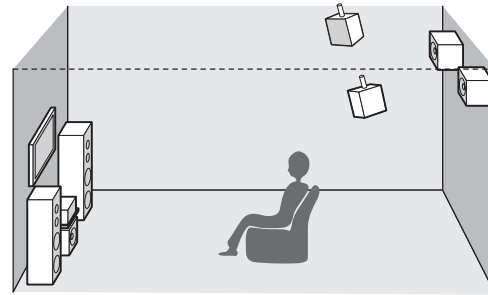

• Surround left and right speakers

These speakers are needed to play surround sound. Place them against the walls in line with the listening position or slightly behind it. Position them so that the center of the speaker front panels point toward the center the room.

• Surround back left and right speakers

Place these speakers behind the listening position as shown in the figure.

Height at which to place the surround left and right speakers and surround back left and right speakers

Place these speakers at a height of 70 cm to 1 meter above the listener.

By placing the speakers at this height, the sound source will not be localized at any specific position, and the listener will feel more surrounded and enveloped by the sound.

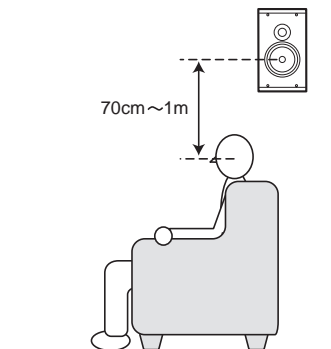

POWER CABLE CONNECTION

Connect the power cable after all the connections have been completed.

1. Plug the accessory power cable into the AC IN socket on the rear panel of the amplifier.

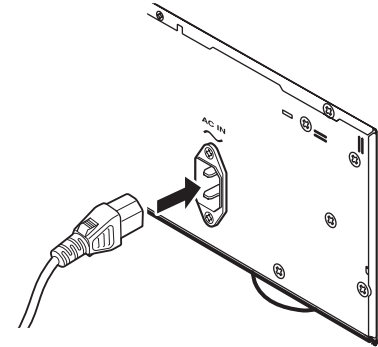

2. Connect the plug on the power cable to the wall socket (AC 120 V, 60 Hz).

* Ensure that the total power consumption of the amplifier and other components connected to the socket does not exceed the capacity of the socket.

Notes:

- Insert the power plug firmly. Noise may be caused by an incomplete connection.
- Do not connect the amplifier to the AC outlet of another product. Product malfunctioning may occur if the capacity of the AC outlet is exceeded.

USING AC OUTLETS

Power can be supplied from the amplifier's AC outlet (UNSWITCHED) to another component up to a maximum power consumption of 150 W. The amplifier's AC outlet is an UNSWITCHED (unswitched) type, which means that the power can be supplied at all times regardless of whether the amplifier power is on or off.

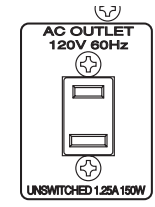

Warning:

Do NOT connect a component that exceeds the absolute allowable power rating. Doing so may cause a fire and/or electric shock.

OPERATION

TURNING THE POWER ON

1. Press the **POWER ON/STANDBY** switch.
2. Sound is output after the standby indicator goes off and the illumination lamp has blinked for about 7 seconds.
The sound output is delayed because of the activation of the muting circuit, which prevents noise from being output until the amplifier's circuitry operates stably after the power has been turned on.
(The illumination lamp is lit while the amplifier is operating.)

Note:

Before turning the power on, turn down the volume controls on the connected components.

TURNING THE POWER OFF

1. Press the **POWER ON/STANDBY** switch.
2. The illumination lamp goes off, the standby indicator lights, and the amplifier goes into standby mode.

Note:

Power is still supplied to some circuits even while the amplifier is in standby mode.

Disconnect the power cable plug from the power outlet when you leave home for a prolonged period.

Make sure you can disconnect the plug from the power outlet at any time in order to prevent possible accidents.

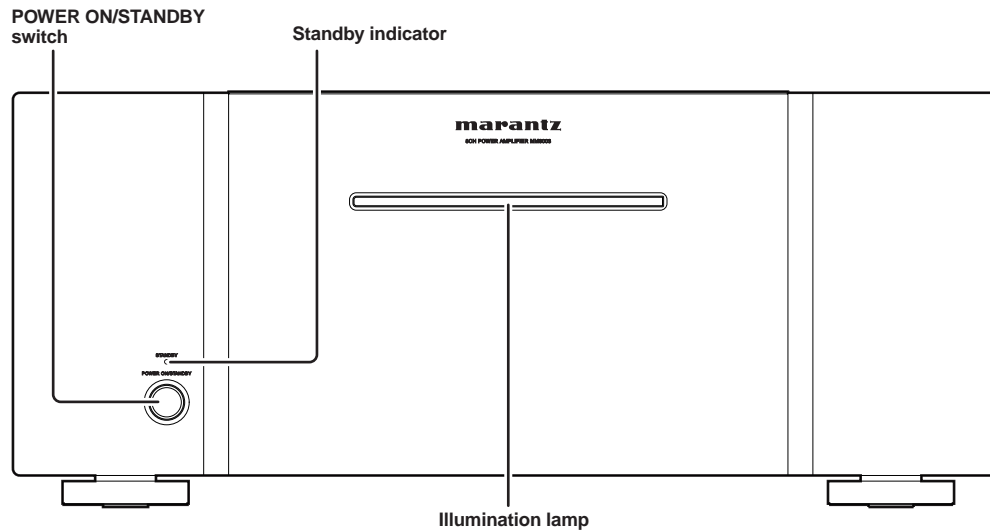

ADVANCED CONNECTIONS

BI-AMPLIFIER CONNECTIONS

Four channels of this unit's power amplifiers are used to achieve bi-amplifier connections to the front speaker systems.

Before connecting the speaker systems, check that they support bi-amplifier connections.

What are "bi-amplifier connections"?

This is a technique for enhancing sound quality, and it involves connecting separate power amplifiers to the bass and mid-range/treble speakers.

By adopting this technique, interference in the mid-range and treble sound caused by the back electromotive force generated by the bass speaker unit can be minimized, improving the sound that can be delivered through the front speakers.

Notes:

- Balanced cables are used in the connection example shown. (Unbalanced cables can also be used for bi-amplifier connections.)
- If the front speaker systems are used in combination with the AV8003 in a bi-amplifier connection, sound will no longer be heard from the surround back channels.

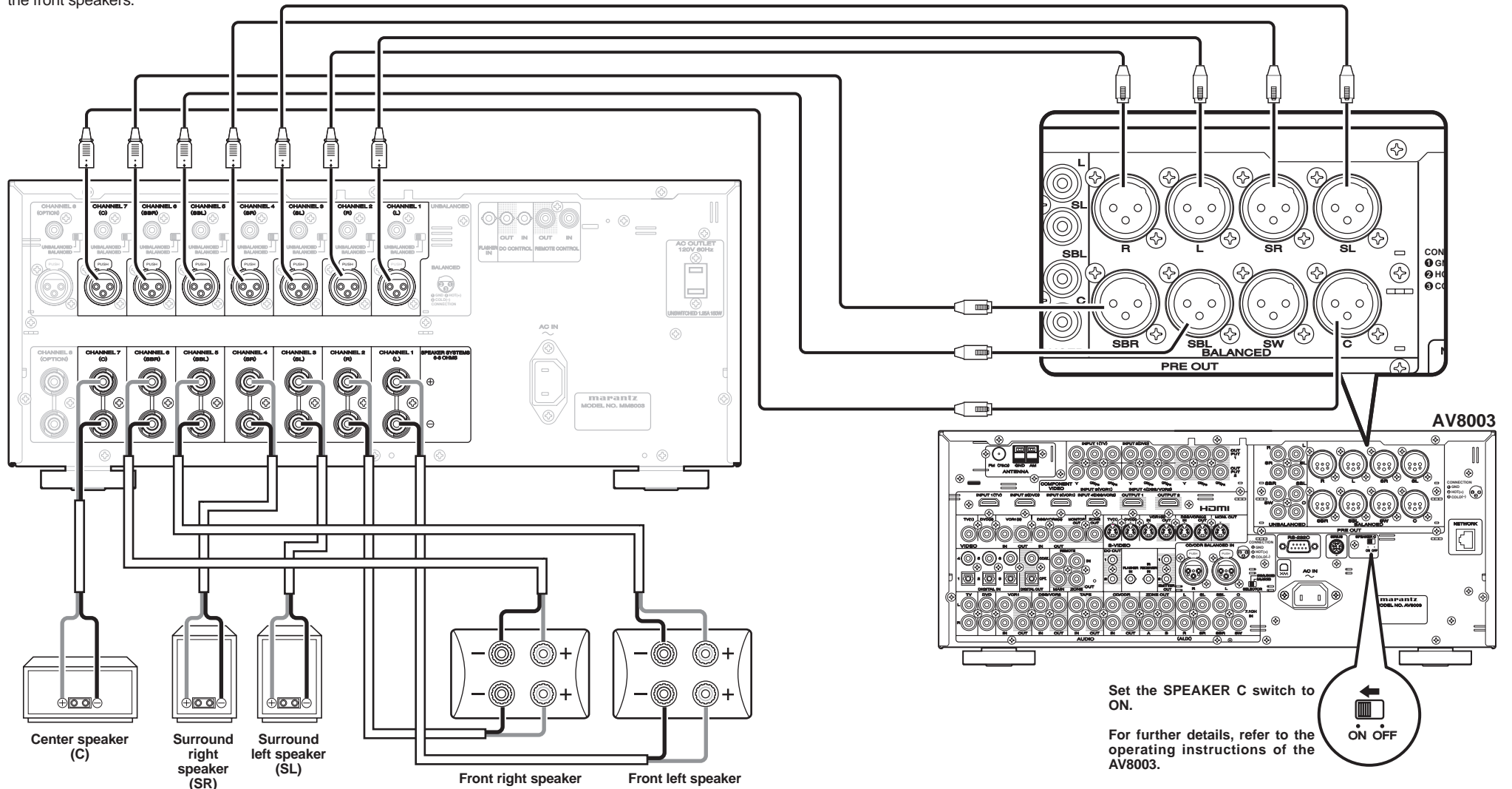

NAMES AND FUNCTION

BASIC CONNECTIONS

OPERATION

ADVANCED CONNECTIONS

TROUBLESHOOTING

OTHERS

MULTI ZONE SPEAKER CONNECTIONS

The example given here shows the connections performed when two pairs of this unit's power amplifiers are used for multi zone speakers in combination with the AV8003. For details on the multi zone speaker function, refer to the operating instructions of the AV8003.

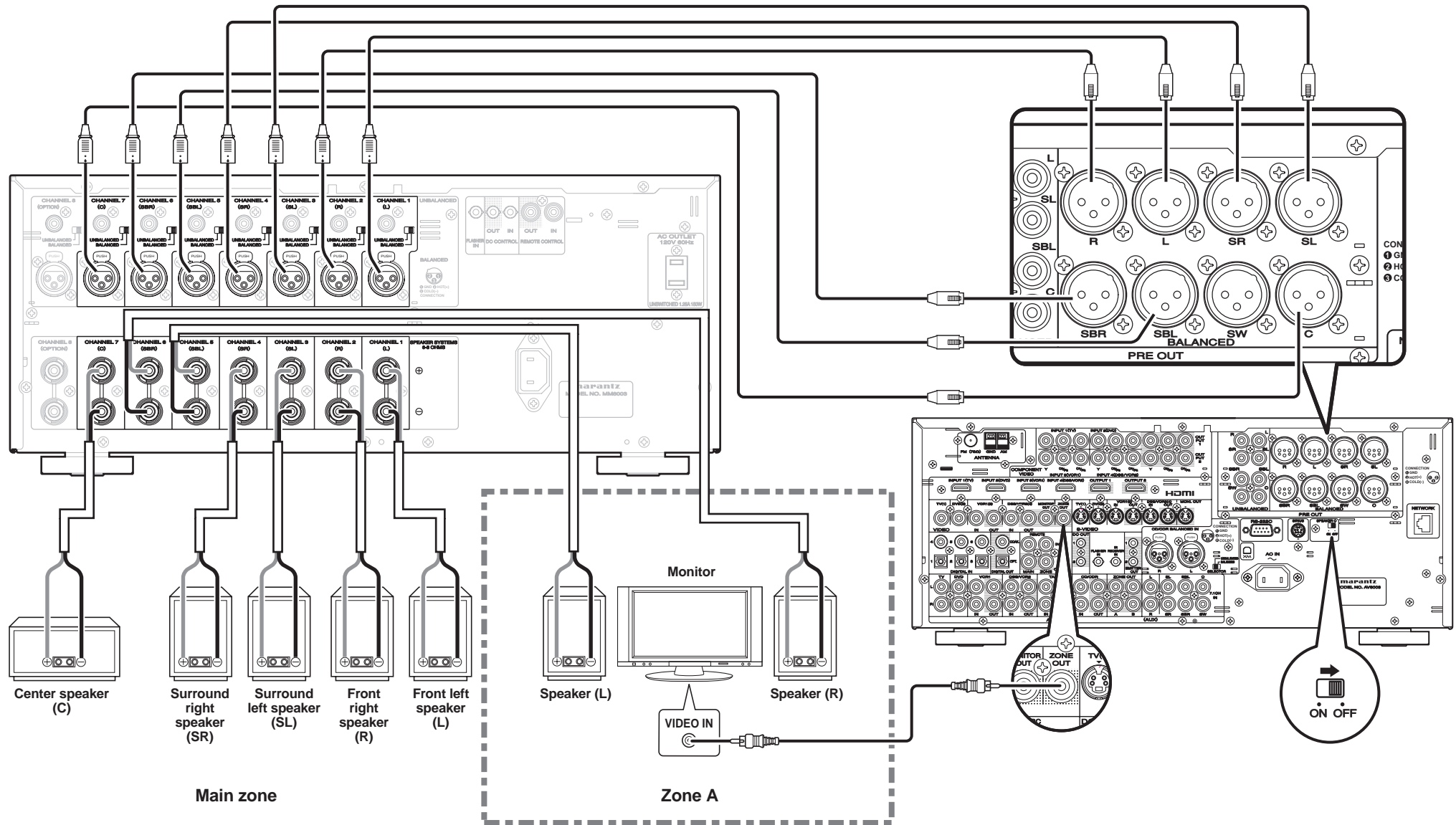

- NAMES AND FUNCTION
- BASIC CONNECTIONS
- OPERATION
- ADVANCED CONNECTIONS
- TROUBLESHOOTING
- OTHERS

MULTI ZONE CONNECTIONS

The example given here shows the connections performed where six pairs of this unit's power amplifiers are connected in combination with the AV8003 for multi zone use. These connections allow the sound to be played in stereo in up to four rooms, including the main room. For details on the multi zone function, refer to the operating instructions of the AV8003.

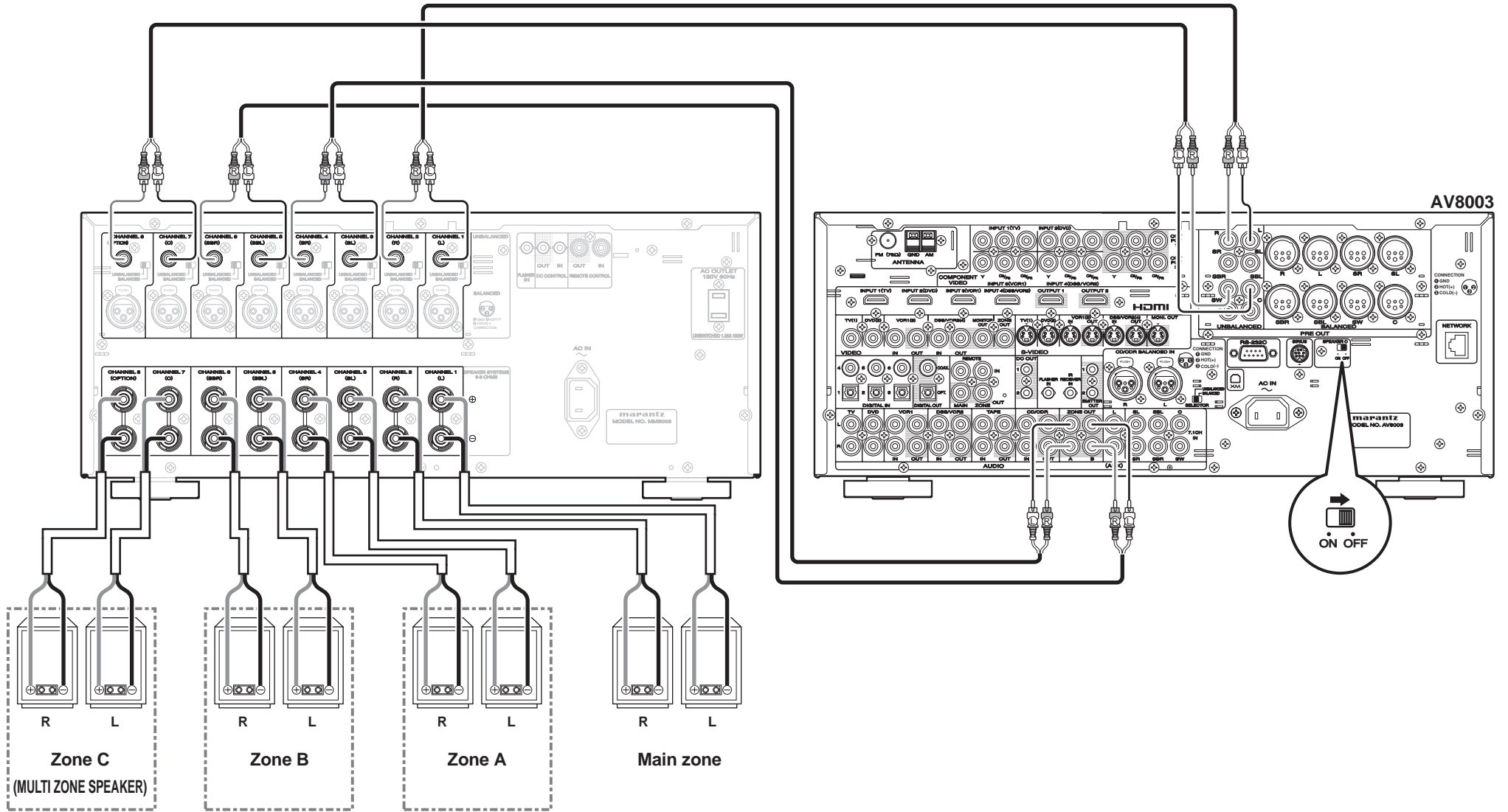

NAMES AND FUNCTION

BASIC CONNECTIONS

OPERATION

ADVANCED CONNECTIONS

TROUBLESHOOTING

OTHERS

REMOTE CONTROL CONNECTIONS

By connecting the remote control connectors on the AV8003 and this amplifier, the amplifier can be set to STANDBY ON/OFF synchronized with the STANDBY ON/OFF operations of the AV8003. For the connection, use the accessory RCA cable to connect the REMOTE CONTROL OUT connector on the AV8003 and the REMOTE CONTROL IN connector on this amplifier. For details on operation, refer to the operating instructions of the AV8003.

AV PRE TUNER AV8003

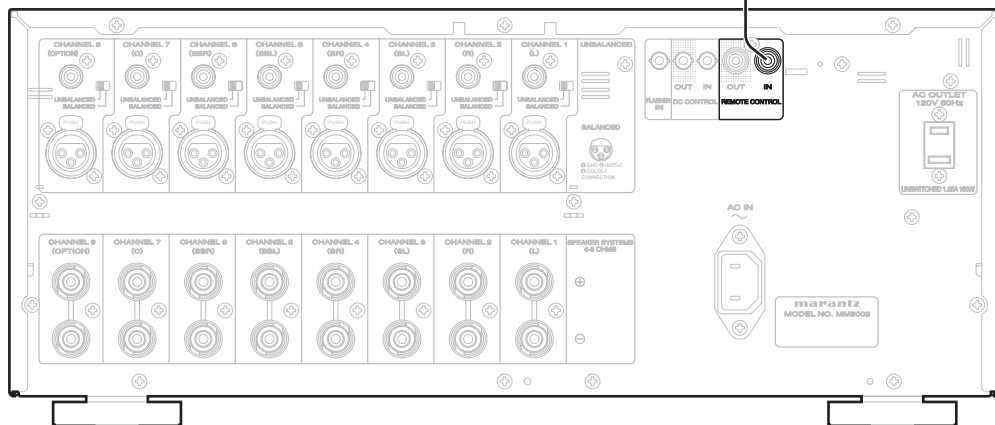
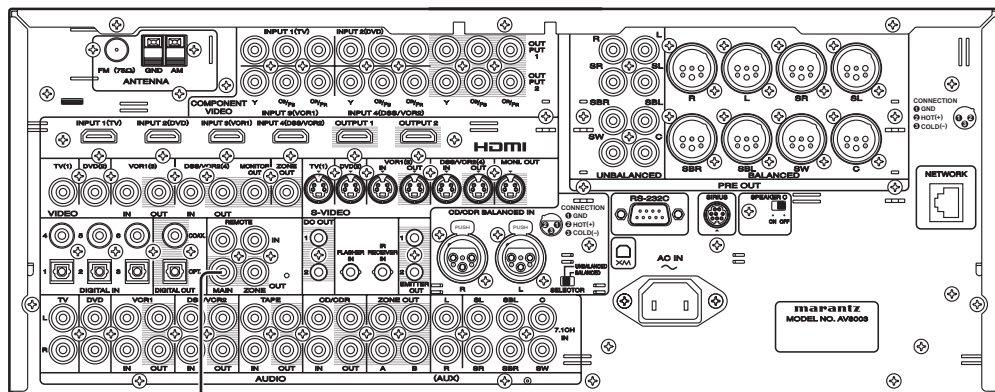

CONNECTIONS WITH EXTERNAL CONTROL COMPONENTS

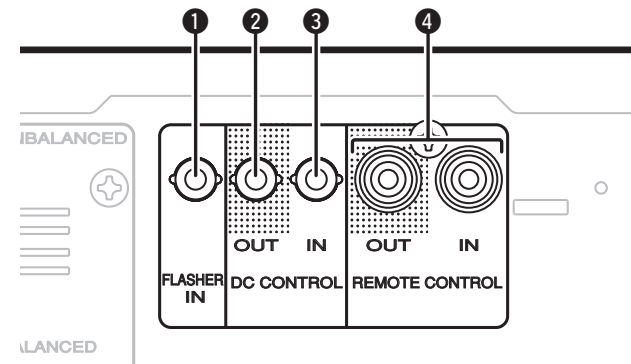

1 Flasher input connector

This is used to control the amplifier from the rooms using a key pad or other device.

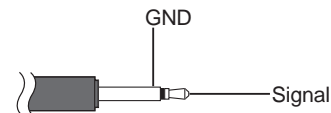

2 DC CONTROL OUT connector

This is used to control external components in tandem with the power on/off operation of this amplifier.

When the amplifier power is OFF, a voltage of 0 V is output from the DC CONTROL OUT connector; when it is ON, a DC 12 V voltage is output.

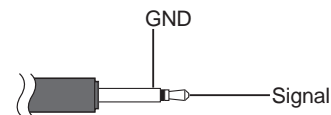

Notes:

- The maximum output current of the DC CONTROL OUT connector is 44 mA. Check the operating instructions of the components to be connected before performing the connections.
- Do not use the DC CONTROL OUT connector as the power supply for external components.

3 DC CONTROL IN connector

This is connected to an external component equipped with a DC CONTROL OUT connector. The amplifier's power on or standby mode can be selected in tandem with the power on/off operation of the component that has been connected to this connector. For details, refer to the operating instructions of the connected component.

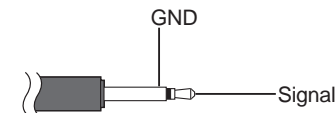

Note:

The amplifier's power is turned on when a voltage in the range of DC 5-15 V is input to the DC CONTROL IN connector. (Standby mode is established with a 0 V input.)

Bear in mind that malfunctioning may result when a voltage higher than 15 V is input.

4 Remote control connector

This is used when configuring a system with another Marantz product and using it to control this amplifier. Connect the REMOTE CONTROL OUT connector of the other Marantz product to the REMOTE CONTROL IN connector of the amplifier and the REMOTE CONTROL IN connector of the Marantz product to the REMOTE CONTROL OUT connector of the amplifier.

Note:

By connecting the amplifier to the AV8003, the amplifier's power can be set to on or standby in tandem with the power on/standby operations of the AV8003. For details, refer to the operating instructions of the AV8003.

TROUBLESHOOTING

If you believe something is wrong with your amplifier, check the following points. Unintentional errors in operation or mistakes made in the connections are sometimes misinterpreted as failure.

If the failure persists even after checking the below points, contact your dealer, your nearest Marantz Consumer Marketing office or customer center, or a Marantz service center.

Symptom	Cause	Remedy	Related page
The amplifier's power fails to come on.	The power plug is not connected.	Insert the power plug into the wall outlet.	7
No sound can be heard from the speakers.	The connecting cables (input) or speaker cables have been incorrectly connected.	Check the cable connections.	5, 6
	The setting of one or more of the input selector switches does not correspond to the input connector (BALANCED or UNBALANCED) to which the cable has been connected.	Set the input switch to the position that corresponds to the input connected to the amplifier.	4
The power suddenly goes off, and the standby indicator blinks slowly (about two times a second).	The temperature inside the amplifier has risen, tripping the protection circuit.	<ul style="list-style-type: none"> Turn off the power, and wait until the amplifier's temperature has fallen to a low enough level before turning the power back on. Check whether the amplifier has been installed in a position that interferes with the dissipation of its heat. 	2
	The protection circuit has been tripped because two conductors ("+" and "-") of a speaker cable are touching each other or because the conductors have made contact with the rear panel or another metal part.	<ul style="list-style-type: none"> Turn the power off, and check the speaker cable connections. Re-process the ends of the conductors of the speaker cables. 	6
	Sound is being played at a volume higher than the performance of the amplifier can deliver.	Turn the power off, turn down the volume control on the control amplifier connected to this amplifier, then turn the power back on.	-
	Speakers with an impedance below the specified rating (6 Ω) are being used.	Use speakers with the specified impedance.	6
The power suddenly goes off, and the standby indicator blinks rapidly (about eight times a second).	The amplifier's protection circuit has been tripped.	Disconnect the power plug from the power outlet, and ask your nearest service center to repair the amplifier.	14

RESETTING THE AMPLIFIER

This amplifier features a microcontroller. The microcontroller can be reset by following the steps below.

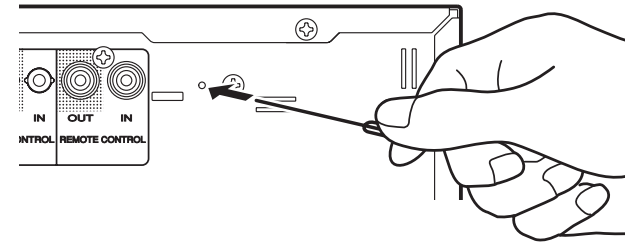

1. Set the amplifier to standby or turn its power on.
2. Use the tip of a needle or other sharp-pointed object to press the reset switch in the hole indicated by the arrow for at least 1 second.
3. When the amplifier power is already on, the amplifier is first set to standby mode, after which the microcontroller is initialized, and the power is turned back on.
When the microcontroller is reset with the amplifier in standby mode, it is initialized, then the power is turned back on.

OTHERS

SPECIFICATIONS

Rated power output (from 20 Hz to 20 kHz/THD = 0.08 % two channels driven)

.....	140 W / ch 8 Ω
.....	170 W / ch 6 Ω

Output bandwidth (8-Ω load, 0.09%)

.....	5 Hz – 40 kHz
-------	---------------

Frequency response (1 W, 8 Ω)

.....	8 Hz – 100 kHz (± 3 dB)
-------	-------------------------

Damping factor

.....	100
-------	-----

Input sensitivity/impedance

.....	1.2 V/ 22 k Ω (UNBALANCED)
.....	2.4 V/30 k Ω (BALANCED)

Signal-to-noise ratio (IHF-A)

.....	105 dB
-------	--------

Voltage amplification level

.....	29 dB
-------	-------

Supply voltage

.....	AC120V 60 Hz
-------	--------------

Power consumption

.....	800 W
-------	-------

Standby power

.....	0.4 W
-------	-------

Weight

.....	17.9 kg
-------	---------

Accessories

Power cable	1
Remote control cable	1
Warranty card	
USA	1
Canada	1
Operating instructions (this document)	1

OUTSIDE DIMENSIONS

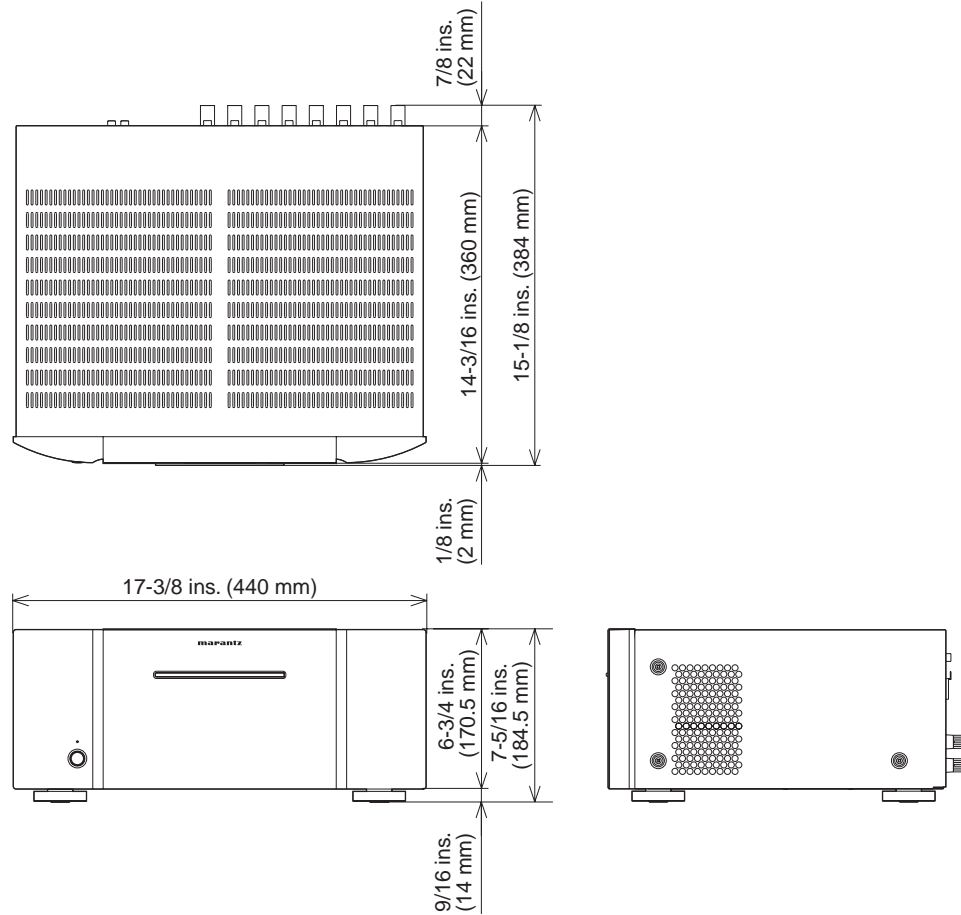

The section describes the care and maintenance tasks that must be performed to optimize the operation of your Marantz equipment.

CLEANING OF EQUIPMENT EXTERNAL SURFACES

The exterior finish of your unit will last indefinitely with proper care and cleaning. Never use scouring pads, steel wool, scouring powders or harsh chemical agents (e.g., lye solution), alcohol, thinner, benzene, insecticide or other volatile substances as these will mar the finish of the equipment. Likewise, never use cloths containing chemical substances. If the equipment get dirty, wipe the external surfaces with a soft, lint-free cloth.

If the equipment becomes heavily soiled:

- dilute some washing up liquid in water, in a ratio of one part detergent to six parts water.
- dip a soft, lint free in the solution and wring the it is damp.
- wipe the equipment with the damp cloth.
- dry the equipment by wiping it with a dry cloth.



REPAIRS

Only the most competent and qualified service technicians should be allowed to service the factory-trained warranty station personnel have the knowledge and special facilities needed for repair and calibration of this precision equipment. After the warranty period has expired, repairs will be performed for a charge if the equipment can be returned to normal operation.

In the event of difficulty, refer to your dealer or write directly to the nearest location to you that is listed on the Marantz Authorized Service Station list. If writing, please include the model and serial number of the equipment together with a full description of what you think is abnormal about the equipment's behaviour.

www.marantz.com

You can find your nearest authorized distributor or dealer on our website.

marantz[®] is a registered trademark.

