

GB

English

N321IX

Index

Operating principle, 4

User's instructions

Installation, 4
Use, 4
Maintenance, 6

Installer's instructions

Installation, 8
Positioning, 8
Electrical connection, 8

Assistance, 10

THIS APPLIANCE IS CONCEIVED FOR DOMESTIC USE ONLY. THE MANUFACTURER SHALL NOT IN ANY WAY BE HELD RESPONSIBLE FOR WHATEVER INJURIES OR DAMAGES ARE CAUSED BY INCORRECT INSTALLATION OR BY UNSUITABLE, WRONG OR ABSURD USE.

Dear customer,

We thank you and congratulate you on your choice. This new carefully designed product, manufactured with the highest quality materials, has been carefully tested to satisfy all your cooking demands. We would therefore request you to read and follow these easy instructions which will allow you to obtain excellent results right from the start. May we wish you all the very best with your modern appliance!

THE MANUFACTURER

GB

User's Instructions

GB

Operating Principle (Fig. 1)

It exploits the electromagnetic properties of most cooking vessels. The coil (inductor) which produces the electromagnetic field is operated and controlled by the electronic circuit. The heat is transmitted to food by the cooking vessel itself. The cooking process takes place as described below.

- loss of heat is minimum (high efficiency)
- the system stops automatically when the vessel is removed or even just lifted from the hob
- the electronic circuit guarantees maximum flexibility and fine adjustments.

Installation

All operations relative to installation (electric connection) should be carried out by skilled personnel in conformity with the rules in force.

As for the specific instruction see part pertaining to installer.

IMPORTANT: This apparatus is not suitable for use by persons (children included) with reduced mental and physical capacity or with lack of experience and knowledge unless having previously received suitable training for its use by persons responsible for their safety.

It must be ensured that children do not play with the apparatus

Use

First place the pan in the chosen cooking zone. If the pan  is not present the system can not be switched on.

On/off of the Touch Control (Fig. 2 e 2a)

 The electronic Touch Control is activated by means of the ON/OFF button and switches from the OFF mode to the Standby mode. To do so it is necessary to press the ON/OFF button for 1 second. A short Beep will be heard. When in standby, "0" is displayed on the display of the cooking zone. This display may go into background due to a residual heat or error signal.

If a cooking zone is activated during the standby time (10 sec.), the control switches over to the On mode.

If no introduction is made within the 10 sec., the control automatically switches to OFF with a short beep.

The electronics can be switched to the OFF mode at any time during the ON mode or the Standby mode by pressing the ON/OFF button. The Off function has priority when operating, meaning that the control switches off even by activating several buttons at the same time.

Switching on a cooking zone

When in the Standby or On mode, a cooking zone can be switched on by means of the Plus/Minus button, as long as the cooking zone is not in the timer programming mode at that moment (see Timer chapter).

If starting with the "+" button, the cooking level changes from "0" to "4". If starting with the "-" button, the cooking level changes from "0" to "9".

Switching off a cooking zone

- a) Pressing the "+" and "-" buttons of the desired cooking zone at the same time
- b) Selecting cooking level "0" of the desired cooking zone with the "-" button

If the last cooking zone is switched off, the control switches to the OFF mode after 10 sec. if nothing else is switched on.

All cooking zones are switched off immediately by pressing the ON/OFF button.

Cooking and power levels

The cooking and power levels of the cooking zones are shown on the display with 7 allotted segments. In accordance with standards, the power levels are displayed with numbers from "1" to "9".

Residual heat indicator



Indicates to the user that the glass is at a dangerous temperature if in contact with the area over the cooking zone. The temperature is determined by means of a mathematical model and possible residual heat is indicated by "H" on the corresponding 7 segment display.

Heating and cooling are calculated based on:

- The selected power level (from "0" to "9");
- The relay activation time after the cooking zone has been switched off.

The corresponding display shows "H" until the zone temperature drops below the critical level (< 60 °C) according to the mathematical model.

Timer function

  The Timer function can be used as a cooking zone timer or independent alarm but never for both functions. The two 7 segment displays of the respective cooking zones are used to view the remaining time in minutes up until the timer alarm is activated.

Timer selection

- To program a timer, the touch control must be in the Standby or On mode.
- The timer button is pressed in order to select a timer function for the cooking zone.
- LED 8 signals the timer programming by means of the +/- buttons. The flashing timer LED signals that the 7 segment display value refers to the timer and can be modified. When a timer continues to function in the OFF mode, the timer LED remains on. This indicates that the value on the display is related to the timer, but cannot be directly modified at that particular moment; to do so, the control must be reactivated.
- The activation of the timer button depends on the

conditions of the previously set function:

- a) The cooking zone corresponding to the timer is on (cooking level > 0): The timer is programmed in reference to the cooking zone; the cooking zone automatically switches off when reset; an independent timer cannot be selected. The cooking level setting is accessed when the timer button is pressed again.
- b) The cooking zone corresponding to the timer is off (cooking level = 0): The timer is independently programmed and continues to function even in OFF. The cooking zone cannot be activated until the timer is functioning.

Setting of the Timer value

- Following the selection of the time, the related LED flashes as described above. The countdown time of the desired timer can be set by means of the +/- buttons.
- Starting with the plus button, the first value displayed is "01" and progressively increases from 1 to a maximum value of "99" (upper limit).
- Starting with the minus button, the value displayed on the indication is "30" and diminishes to "01" (first lower limit). When this value is reached, an acoustic signal is emitted. By pressing the minus button again, the display "00" will not be modified (second lower limit).
- Setting can be performed by permanently pressing the plus or minus buttons or by intermittently pressing them (selection: press button, release, press button, release, etc).
- If the button is permanently pressed, the regulation speed automatically accelerates, meaning that the time between one step and the next is reduced, until the button is released.
- If the Plus or Minus buttons are not pressed within 10 sec. (parameter), after having selected the timer of the current cooking zone (the display remains on "00"), the indication and allocation of the +/- buttons automatically switch to the cooking zone.
- When a timer is used as an alarm, the indication and allocation of the buttons does not switch to the cooking zone, being that this cannot be activated.
- The timer normally starts in countdown, if programmed with two values that are not 0. For example: the timer starts when the Plus button is released after the timer value has been set at "01".
- The timer settings have priority over the delimitation of the operating time if high cooking levels have been set.
- If only one alarm has been programmed, the control remains at first in the standby mode (no other cooking zone is on). If no other new values are introduced, the TC behaves as described above and switches to the OFF mode.

Timer laps/timer alarm and confirmation

- The last 10 sec. before the timer lapses are displayed (countdown up to alarm).
- Once the set time of the timer has lapsed, the timer alarm is activated and the assigned cooking zone is

switched off.

- The display and the selected timer LED flash alternating the cooking level from "00" to "H", if there is residual heat.
- The warning alarm lasts for at least 2 minutes if the user does not switch it off before.
- The alarm signal switches off after the 2 minutes is up or if any button is pushed. The buzzer and the timer control light are switched off.

Timer off /Modification of the timer setting

- The timer settings can be modified in the Standby or On mode at any time after the selection has been made by pressing the Plus or Minus buttons.
- The timer can be switched off, setting it to value "00", by pressing the Minus button or by pressing the Plus and Minus buttons together.

Key Lock (child safety)

● Locking/unlocking of the Key Lock



The keypad is blocked when the Key Lock button is pressed in the Standby or On mode; the Key-Lock LED "9" lights permanently. The control continues to operate in the previously set mode but can no longer be controlled by other buttons, except by the Key-Lock button or the ON/OFF button. Switching off with the ON/OFF button is also possible when locked. The Key-lock button LED switches off when the Touch control and Key-Lock function are switched off. The LED lights again if reactivated (within 10 sec.) until it is deactivated by pressing the Key-Lock button once again. The activation/deactivation of the Key-Lock function is not possible in the OFF mode.

Unlocking/deactivation of the Key Lock

The keypad is unlocked and the Key-Lock LED is switched off when the Key-Lock button is pressed again in the Standby or On mode. All sensor buttons can once again be activated.

Keep- warm function (Lo Temp)



The keep-warm function serves to keep the food on a cooking zone warm. To do so, the selected cooking zone is supplied with a lower power. The keep-warm function is activated by setting the cooking level between 0 and 1. The "Lo" symbol is thereby indicated on both cooking zone displays (see above). Lowering the cooking temperature with the "-" button pressed, the temperature stops on the keep-warm cooking level. Push the button again to switch to "0".

Precautions

- in case you detect a crack, however small, in the hob surface, immediately disconnect the power supply

- when the hob is in use keep all magnetizable objects away (credit cards, floppy disks, calculators and so on)
- do not use any aluminium foil or place any foodstuffs wrapped in aluminium foil directly on the hob
- do not place any metal objects such as knives, forks, spoons and lids on the hob surface as they will heat up
- when cooking in a nonstick pan without seasoning, do not exceed 1-2 minutes' pre-heating time
- when cooking food that may easily stick, start at a low power output level and then slowly increase while regularly stirring.
- after cooking is finished, switch off using the control provided (turn down to "0"), and do not rely on the pan sensor.

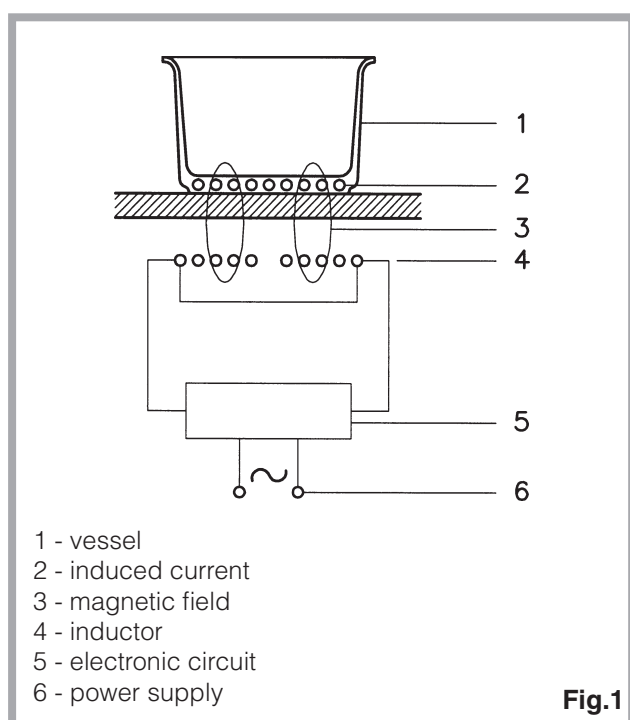

Cooking vessels (Fig. 3)

- a magnet attracting vessel may be a suitable vessel for induction cooking
- prefer vessels which are especially declared to be suitable for induction cooking
- flat and thickbottomed vessels
- a vessel with a 20 centimeter diameter ensures the maximum exploitation of power
- a smaller vessel reduces power exploitation, but does not cause any energy loss We would anyhow not recommend the use of vessels with diameters smaller than 10 cm.
- stainless-steel vessels with multilayer or ferritic stainless-steel bottoms when specifically suited for induction cooking
- cast iron preferably enamel bottomed vessels to avoid scratching the pyroceram surface
- we do not recommend the use of any glass, ceramic, earthenware, aluminium, copper or non-magnetic (austenitic) stainless-steel vessels.

Maintenance (Fig. 4)

By means of a scraper immediately remove any aluminium foil bits, food spills, grease splashes, sugar marks and other high sugarcontent food from the surface in order to avoid damaging the hob.

Subsequently clean the surface with some paper towel and SIDOL or STANFIX, rinse with water and dry by means of a clean cloth.

Under no circumstance should sponges or abrasive cloths be used; also avoid using aggressive chemical detergents such as oven sprays and spot removers.

DO NOT USE STEAM CLEANERS

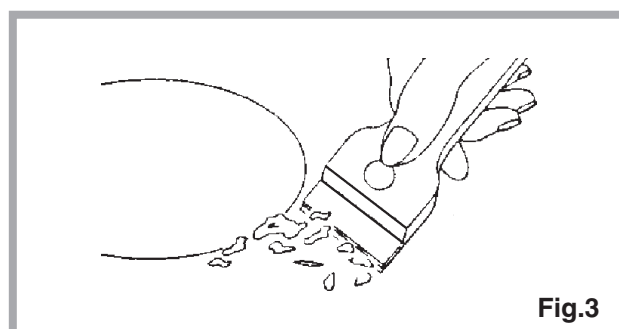
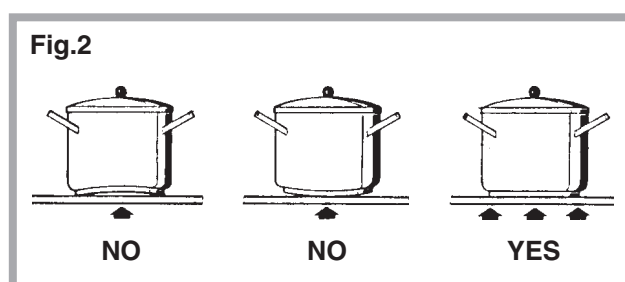
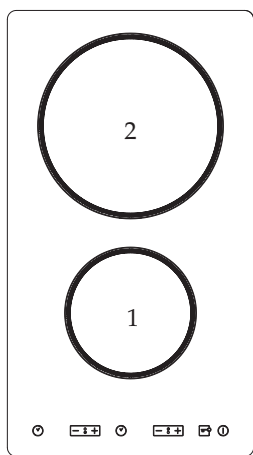
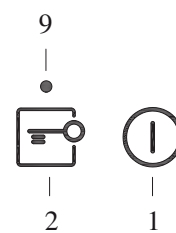
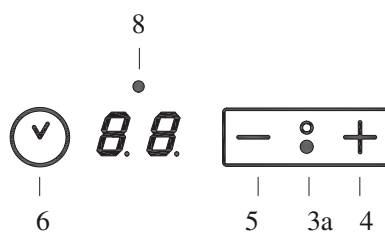
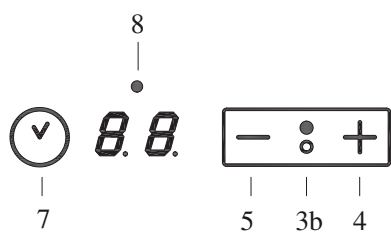

Fig.4



- 1. cooking zone Ø 160/1400W
- 2. cooking zone Ø 200/2300W

- 1. On/Off
- 2. Child safety (key lock)
- 3. Cooking zone indication
- 4. Power increase
- 5. Power Decrease
- 6. Timer/a
- 7. Timer/b
- 8. Timer Led
- 9. Key lock Led



Installer's Instructions

GB

Installation

These Instructions are for the qualified technician, as a guide to installation, adjustment and maintenance, according to the laws and standards in force. These operations must always be carried out when the appliance has been disconnected from the electric system.

Positioning (Fig. 5)

The fixture is especially designed for fitting into a worktop as shown in the corresponding figure.

Place the supplied sealing agent along the hob perimeter.

Do not install the hob over an oven; incase you do, make sure of the following:

- the oven is equipped with an appopriate cooling system
- there isno warm-air leakage from the oven to wards the hob
- suitable air-inlets are provided as shown in the figure.

Electrical connection (Fig. 6)

Prior to carrying out the electrical connection, please ensure that:

- the plant characteristics are such as to follow what is indicated on the matrix plate placed atthe bottom of the working area;
- that the plant is fitted with an efficient earth connection, following the standards and law provisions in force. The earth connection is compulsory interns of the law.

Should there beno cable and/or plug on the equipment, use suitable absorption material for the working temperature as well, as indicated on the matrix plate. Under no circumstance must the cable reach a temperature above 50°C of the ambient temnerature.

If connecting directly to the mains power supply, fita multi-poie switch ofa suitable size for the rated capacity with a clearance distance which completely disconnects the power line under over voltage category III conditions, consistently with the rules of installation (the yellow/green earth wir must not be interrupted). The plug or omnipolar switch must be easily reached on the installed equipment.

N.B.: The manufacturers decline any responsibility in the event of non-compliance with what is described above and the accident prevention norms not being respected and followed.

To avoid all risk, if the power cable becomes damaged, it must only be replaced by the manufacturer, by an authorised service centre, or by a qualified electrician.

Fig.6

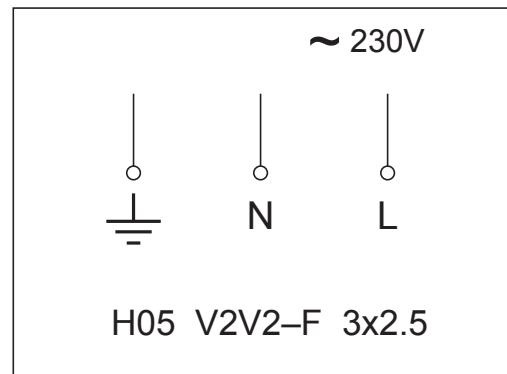

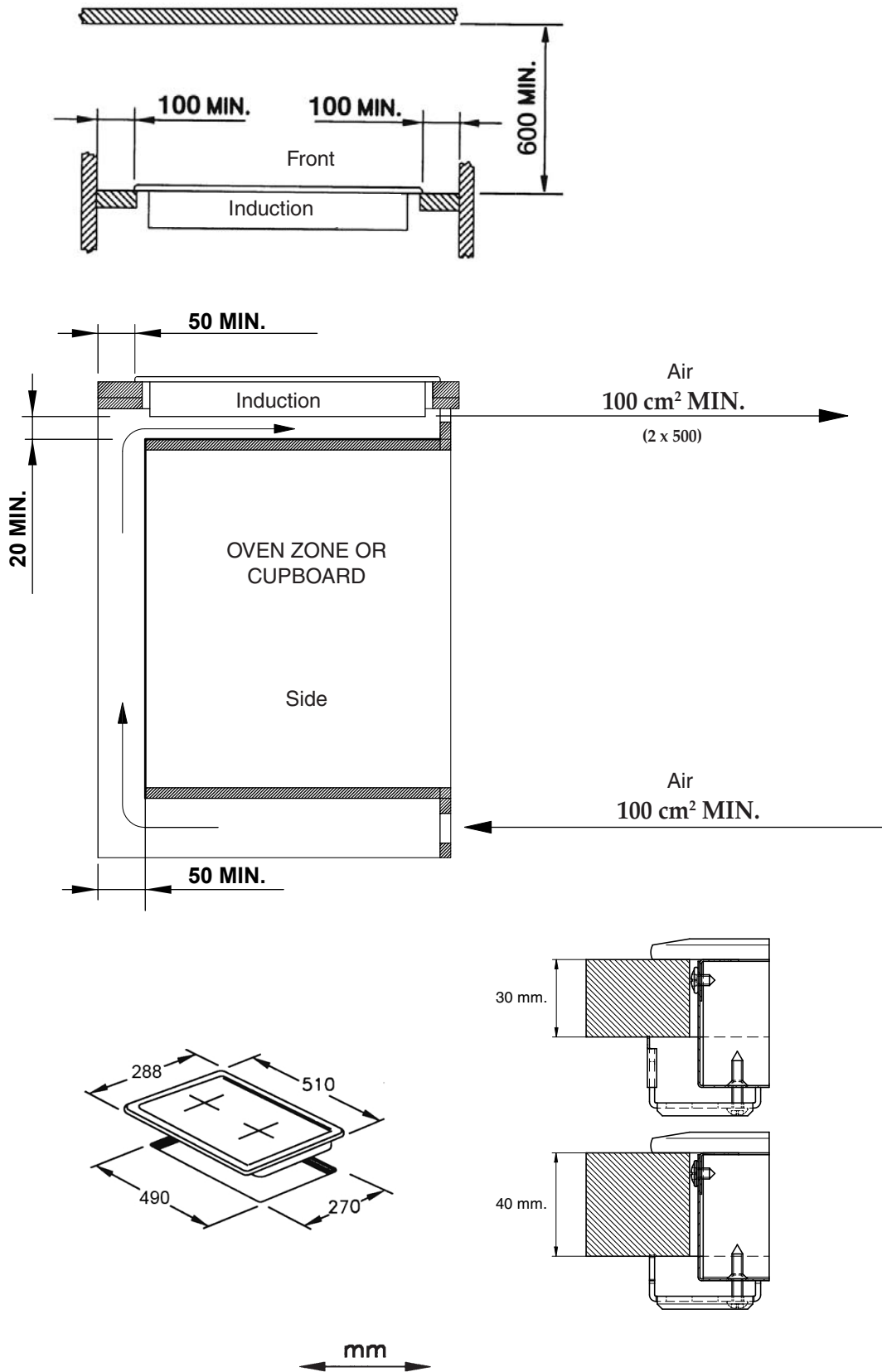

Fig.5

Assistance

GB

Before contacting After-Sales Service:

1. See if you can solve the problem yourself.
2. Switch the appliance on again to see if the problem has been solved. If it has not, disconnect the appliance from the power supply and wait for about an hour before switching on again.
3. If the problem persists after this course of action, contact After-Sales Service.

Specify:

- the nature of the fault,
- the model
- the service number (the number after the word SERVICE on the rating plate on the rear of the appliance)
- your full address,
- your telephone number and area code.

Never call on unauthorized technicians and always refuse to purchase non-original spare parts.

The manufacturer declines all responsibility for possible inaccuracies contained in this pamphlet, due to printing or copying errors. We reserve the right to make on our own products those changes to be considered necessary or useful, without jeopardizing the essential characteristics.

