

Hotpoint Service Offices

SERVICE CALL: If you have a problem with your appliance ring your local Service Office. SPARES and ACCESSORIES: To purchase spares and accessories send your Accessories Order Form to your Spares Centre. If the accessory or spare part you want is not on the form then contact your Spares Centre for prices and availability. Please address all correspondence to Hotpoint Spares Centre or Hotpoint Service Office as applicable.

Service Offices and Spares Centres are open between 8.30am-5.00pm Monday to Friday, except on Public Holidays. 8.30am-12.30pm Saturdays

EASTERN

- **NORWICH:** 92 Inner St, Giles Street, NR2 1LT. Tel: Norwich (0603) 620581.
- **PETERBOROUGH:** Cella Road, PE2 9JR. Tel: Peterborough (0733) 64741.
- **LUTON:** 50 Cowley Road, LU1 1HX. Tel: Luton (0582) 462211.
- **CHELMSFORD:** Industrial Buildings, Beehive Lane, CM2 9TE. For postal orders, RM 16. Reimsford (0245) 492433. Reimsford (0245) 268331. Chelmsford (0245) 268331.

EAST MIDLANDS

- **LEICESTER:** 65 Belgrave Gate, LE1 3HR. Tel: Leicester (0533) 514485.
- **WELLINGBOROUGH:** 395 Cambridge Street, NN8 1DW. Tel: Wellingborough (0933) 223669.
- **NOTTINGHAM:** Ashington Street, NG2 3JB. Tel: Service Office Nottingham (0602) 662431. Spares Centre Nottingham (0602) 660387.

LONDON and SOUTH EAST

- **Sutton:** 2 St. Nicholas Road, SM1 1EH. Tel: 081-649 0921.
- **HAINSLHAM:** 1 Kingswood, North Street, BN7 1DD. Tel: Hainslam (0323) 842733.
- **WEMBLEY:** 68 East Lane, HA9 7ZD. Tel: Offices for S. Herts and Middlesex 081-904 4309. Office for NW, VIC: SW 1, 3, 5, 6, 7, 10 081-904 1250. N-E: EC 081-908 4722. SE and SW: 081-904 0200.
- **LARKFIELD:** Larkfield Trading Estate, Newlynite, ME20 6SN. Tel: Service Office Maidstone (0622) 716571. Spares Centre Maidstone (0622) 716681.

CHANNEL ISLANDS

— Service provided by agents

The normal United Kingdom guarantees apply and all services schemes are available.

- **JERSEY:** 19 Don Street, St. Helier. Tel: (0534) 21025.
- **Clos D'Ormes, Pontac, St. Clements:** Tel: (0534) 548006.
- **GUERNSEY & SARK:** Valpays Stores, Grande Rue, St. Martin, Guernsey. Tel: (0481) 38422.
- **15 Le Poller, St. Peter Port, Guernsey:** Tel: (0481) 23311.
- **Lowlands, Braye Road, Vale, Guernsey:** Tel: (0481) 48264.
- **ALDERNEY:** 32 High Street, Alderney. Tel: (0481) 822686.

Spares and accessories may be ordered from Hotpoint Spares Administration Dept., Celta Road, Peterborough, PE2 9JB.

In accordance with its policy of progressive product design, the Company reserves the right to alter specifications. Hotpoint Ltd, Peterborough, PE2 9JB, England

E9503

HOTPOINT SLOT-IN COOKER

USER HANDBOOK AND INSTALLATION INSTRUCTIONS MODEL 6511



- Service Office and Spares Centre
- Service Office only

SOUTH MIDLANDS

- **DIDCOT:** 224 Broadway, OX11 8BS. Tel: Didcot (0235) 617711. Spares and accessories may be ordered from either Aldridge or Wembley Centres.

SOUTH WEST

- **BRISTOL:** 3/5 Brislington Hill, Brislington, BS4 5SD. Tel: Bristol (0272) 714471.
- **PLYMOUTH:** 69 Mutley Plain, PL4 6JH. Tel: Plymouth (0752) 262631.
- **TOTTON:** South Hampshire Industrial Park, Salsbury Road, SO4 3SA. Tel: Service Office Totton (0703) 861981. Spares Centre Totton (0703) 867933.

WALES

- **LLANDUDNO JUNCTION:** Conwy Road, LL31 9RZ. Tel: Llandudno (0492) 582626.
- **BRIDGENY:** 18 Western Avenue, Bridgend Industrial Estate, CF31 3SL. Tel: Service Office Bridgend (0656) 664121. Spares Centre Bridgend (0656) 766111.

WEST MIDLANDS

- **STOKE ON TRENT:** West Avenue, Nelson Estate, Talke, ST7 1TN. Tel: Stoke (0782) 774511.
- **ALDRIDGE:** Westgate, WS9 8UX. Tel: Service Office Aldridge (0922) 743374. Service Office for Postal Codes B (0922) 743376. All other postal codes (0922) 743605. Spares Centre Aldridge (0922) 743377.

IRELAND

- **Northern Ireland:** 256 Ormeau Road, Belfast, BT7 2FZ. Tel: Belfast (0232) 647111.
- **Fire:** 49 Airways Ind Estate, Dublin 17. Service Office (0001) 426088. Spares Centre (0001) 426086. Spares and accessories may be ordered from either address.

Ref No. 4847 00021

Hotpoint®

Before you operate your new Hotpoint Slot-In Cooker

Please read these instructions fully.

1. Ensure that the cooker is installed by a qualified electrician following the instructions below. Your cooker should **not** be located adjacent to a gas heater as flames from the burners could cause damage to your cooker.
2. For your own safety and to get the best results from your cooker it is important to read right through this Handbook **before** using your cooker for the first time.
3. Before using the ceramic hob for the first time wipe the ceramic area with the Ceramic Hob Cleaner-Conditioner (Hotpoint Part No. 6004 – obtainable either through a local Hotpoint Service Centre or retailer).

Installation

- **Unpacking the appliance**
The cooker should be carefully unpacked and checked for damage. Ensure that no packaging material is left inside the oven cavities.
- **Siting the Cooker**
The cooker is designed to be flush between standard kitchen units spaced a minimum 500mm apart. The clearance either side need only be sufficient to allow withdrawal of the cooker for servicing. It can be used with cabinets on one side or both, as well as in a corner setting. It can also be used freestanding. Adjacent side walls which project above the hob level should be protected by heat resistant material, but in any case should not be nearer to the cooker than 100mm. Any overhanging surface or cooker hood should not be nearer than 650mm.
- Any electrical wiring must be carried out in compliance with the appropriate IEE and electricity board regulations by a qualified electrician, eg. your local electricity board or a contractor who is on the roll of the National Inspection Council for Electrical Installation Contracting (NICEIC).
- **WARNINGS – INCORRECT INSTALLATION COULD AFFECT THE SAFETY OF THE APPLIANCE.**
 - **ALL APPLIANCES MUST BE EARTHED.**
 - **BEFORE CONNECTING OR INSTALLING THE COOKER THE ELECTRICITY SUPPLY MUST BE SWITCHED OFF.**
- **IMPORTANT: The earth connection on this appliance must be made using a box spanner to avoid strain on adjacent terminals.**
- The installer **must** check that the voltage shown on the rating plate corresponds with the house electricity supply.
- The cooker **must** be connected to a suitable double pole isolating switch (cooker control unit) having a contact separation of at least 3mm in all poles placed in a readily accessible position adjacent to the cooker.
- Access to the mains terminals is gained by removing the rear access cover.
- The mains cable must pass through the cable clamp adjacent to the terminal block. Sufficient cable should be used to allow the cooker to be pulled out for servicing.
- The main cooker control unit **must** be switched **ON** for any part of the cooker to function. In houses fitted with a 30 milliamp RCCB, the combined use of your slot-in cooker and other domestic appliance may occasionally cause the RCCB to trip. In the unlikely event of the RCCB repeatedly tripping contact your local Hotpoint Service Office. In some instances it may be necessary to fit a 100 milliamp RCCB.
- **Height Adjustment:**
The delivered height of your cooker is set at 902mm to the top of the hob side trims. The minimum height of the cooker is 900mm if the plastic feet under the plinth are removed, with care, using a suitable tool.
Levelling washers/height adjustment washers – 1 x 10mm and 2 x 2mm for each foot (packed in a polythene bag) are provided for use when the cooker is sited on an uneven floor. You can increase the height, by plugging the levelling washers into the plastic feet (under the plinth) to 902, 904, 910, 912 or 914mm to ensure that the cooker is level and does not 'rock'. A second person should hold the cooker whilst it is lifted backwards to gain access to the feet.
The cooker should not be installed with the hob height below the worktop height.
Before sliding the cooker into position, measure that height of the units next to the cooker from the floor to the worktop at front and back.
Lower top oven door, place hands on the top oven roof avoiding any damage to the grill elements and carefully locate cooker into position.
Check the level of the cooker by placing a spirit level on the top of the cooker fascia taking care not to scratch the surface. Make any adjustments necessary.
The maximum loading of your cooker is 11.16kW.

NOTE: Children should not be allowed to play with the appliance or tamper with the controls.

Hotpoint Service Cover

Satisfaction Guaranteed or Your Money Back

Hotpoint gives you a unique 'Satisfaction Guaranteed' promise – valid for ninety days after you have purchased your Hotpoint product. If there is a problem with your Hotpoint appliance just call your Hotpoint Service Office. If necessary we will arrange for an engineer to call. If the problem is not resolved by us under this Guarantee, Hotpoint will replace your appliance or, if you prefer, give you your money back. This Guarantee is additional and subject to the terms of Hotpoint's Five Year Parts Guarantee.

Hotpoint's Free Five Year Guarantee

From the moment your appliance is delivered, Hotpoint guarantees it for **FIVE YEARS**.

- In the Five Years all replacement parts are **FREE** provided they are fitted by our own Service Engineer. During the first year our Engineer's time and labour is also free.
- After the first year we will charge for our Engineer's time and labour. We do, however, operate a range of Service Plans (see opposite) which for an annual payment enables you to cover any repair costs which may be necessary.
- All of our service repairs are guaranteed for twelve months in respect of our labour and any parts fitted.
- The appliance must be used in the United Kingdom and must not be tampered with or taken apart by anyone other than our own Service Engineer.
- You may, however, buy parts which can be safely fitted without specialist knowledge or equipment. The correct fitting of such parts, provided they are genuine Hotpoint spares, will not affect your Guarantee. Parts are available from our main Hotpoint Spares Centres (see back page).
- Our Guarantee does not cover the cost of any repair which is needed because of power cuts, accidents or misuse. Nor does it cover the cost of any visit to advise you on the use of the appliance. Please read the instruction book thoroughly.
- If at any time during the Guarantee period we are unable to repair your appliance, we will refund any repair costs paid to us in the previous twelve months. We will also offer you a new appliance at a reduced charge instead of a repair.
- Our Guarantee is in addition to and does not affect your legal rights.
- Should you need independent advice on your consumer rights, help is available from Your Consumer Advice Centre, Law Centre, Trading Standards Department and Citizens Advice Bureau.

Contents

Before you operate your new Hotpoint Slot-In Cooker	2
The main parts of your Cooker	4
Changing the Main Oven door hinging	5
The cooking systems in your Cooker	6
The Controls	7-8
The Timer	9-10
Use and Care of the Ceramic Hob	11-13
Top Oven – Grilling	14
Top Oven – Conventional Cooking	15
Main Oven – Fan Cooking	16
Temperature Conversion Chart	17
Care and Cleaning of the Cooker	18-20
If something goes wrong	21
If it still won't work	21
Hotpoint Service Cover	22
Hotpoint Service Offices and Spares Centres	back page

Retention of this Instruction Book

This Instruction Book must be kept handy for reference as it contains important details on the safe and proper use of the appliance.

If you sell or pass the appliance to someone else, or move house and leave it behind, make sure this Book is also provided so the new owner can become familiar with the appliance and safety warnings.

If the Book is lost or damaged a copy must be obtained from Hotpoint Ltd, Celta Road, Peterborough, PE2 9JB.

- All Hotpoint servicing is done by our own Service Organisation located throughout the United Kingdom and Southern Ireland. It will be happy to deal with any problems.

Hotpoint's Service Care

Whether you have just one or a number of Hotpoint appliances in your kitchen, Hotpoint has a range of Service Schemes to give you complete peace of mind.

Service Cover

A single payment covers you for all repairs during the period of cover, which can be from 1 to 4 years. There is also an option of Service Cover with Maintenance at an additional cost. This includes an annual Electrical and Safety check and replacement of any parts as necessary. For 1 year contracts this takes place towards the end of the contract period.

Kitchen Cover

An annual payment covers you for all repairs for all your Hotpoint appliances which are less than 10 years old. It also covers the cost of loss of food up to £250 in our refrigeration and freezer products. There is also the option of Kitchen Cover with Maintenance at an additional cost. Any additional Hotpoint appliances purchased after you have joined Hotpoint Kitchen Cover will automatically be included during the annual period of cover without further charge.

Appliance Registration

To ensure that you have the opportunity to benefit from any of the above Service Schemes you should complete and return immediately the Appliance Registration Form supplied with your appliance. Full details and costs of our Service Schemes together with an application form will be sent to you at the end of the first year of the guarantee.

Annual Safety/Maintenance Checks

Hotpoint strongly recommends that all its appliances are regularly checked for electrical and mechanical safety whether or not they are covered by a Service Plan.

Proof of Purchase

For future reference please attach your purchase receipt to this booklet and keep it in a safe place.

Spares and Accessories

Spares and accessories can be ordered from your local Hotpoint Spares Centre (listed on the back page), using the order form enclosed.

The Main Parts of your Cooker

WARNING: DO NOT TOUCH THE OVEN DOORS WHEN THE OVEN IS IN USE AS THESE AREAS CAN BECOME HOT.

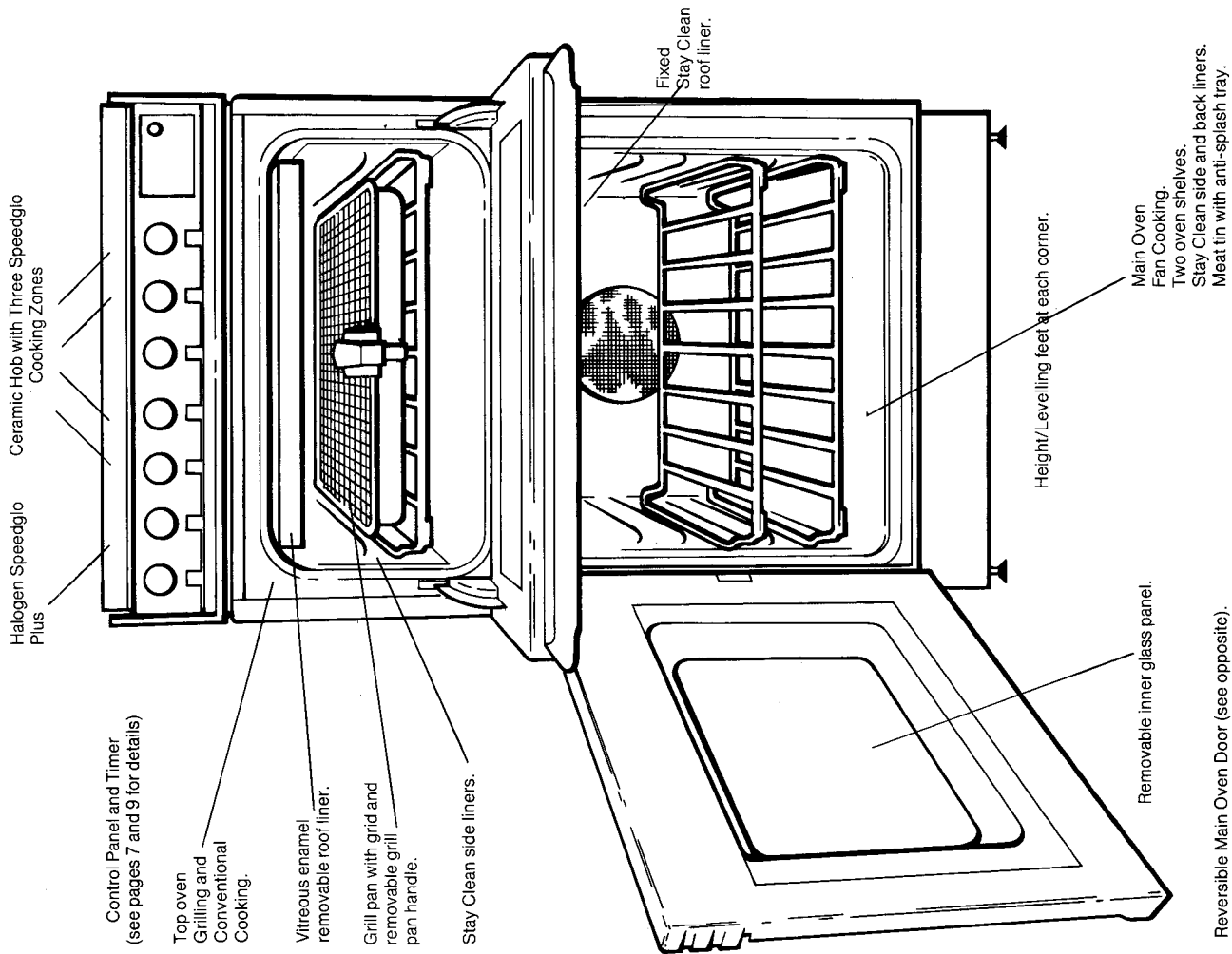

Halogen Speedglo Plus
Ceramic Hob with Three Speedglo Cooking Zones

Control Panel and Timer
(see pages 7 and 9 for details)

Top oven
Grilling and
Conventional
Cooking.

Vitreous enamel
removable roof liner.

Grill pan with grid and
removable grill
pan handle.

Stay Clean side liners.

Fixed
Stay Clean
roof liner.

Height/Levelling feet at each corner.

Removable inner glass panel.

Main Oven
Fan Cooking.
Two oven shelves.
Stay Clean side and back liners.
Meat tin with anti-splash tray.

If something goes wrong . . .

First, don't panic! There may be nothing wrong. Check the points below before calling your Hotpoint Service Office.

1. Check that the mains supply is switched on.
2. Check that the Automatic Cooking Programme has not been selected; if it has switch the oven back to Manual control (see page 10).
3. If using the Grill in the Top Oven make sure that the Top Oven Control is set to 'O' Off (see page 7).

Spare Parts

Please remember your new appliance is a complex piece of equipment. 'DIY' repairs or unqualified and untrained service people may put you in danger, could damage the appliance and might mean you lose cover under Hotpoint's Parts Guarantee.

If you do experience a problem with the appliance don't take risks; call in Hotpoint's own Service Engineer. The address and telephone number of your nearest Hotpoint Service Office is in your local telephone directory.

Our spare parts are designed exclusively to fit only Hotpoint appliances. Do not use them for any other purpose as you may create a safety hazard.

If it still won't work . . .

Contact the Service Office

If there is still a problem with your Cooker after checking the points above:

1. Switch off the Cooker at the cooker control panel.
2. Call your nearest Hotpoint Service Office or local importer (outside the UK). The telephone number is shown on the back page. Note the number down in the space below:

.....

When you contact us we will want to know the following:

1. Your name, address and post code.
2. Your telephone number.
3. Clear and concise details of the fault.
4. The model number (6511), serial number (situated on the front of the cooker below the main oven door) and the colour.
5. The date of purchase. Enter the date here:

6. If you have taken out one of the Hotpoint Service Schemes.

Please make sure you have all these details ready when you call.

Changing the Main Oven door hinging

WARNING: Switch off the electricity supply to the cooker at the cooker control unit before changing the door hinging.

A pack of fittings is supplied with the information pack in the cooker. This contains:

- 50mm double sided tape
 - Door pull sticker
- You will need a No.2 Posidriv screwdriver.

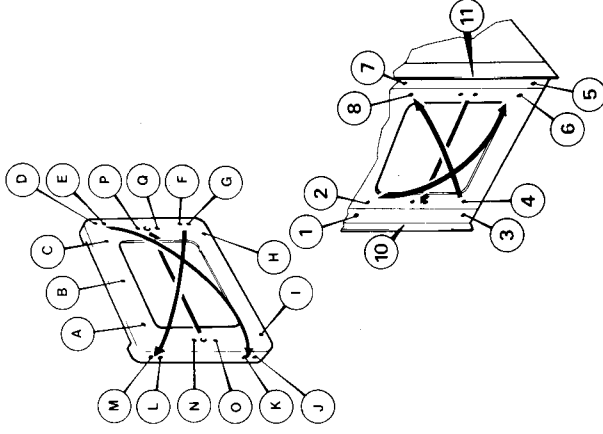

- Remove screws A, B, C, H and I to remove the inner panel from the outer glass and handle.
- Remove door catch N and O and blanking plate P and Q and replace on opposite sides of the door. A 7 mm spanner may be required.
- Remove screws M and L, K and J. Also remove screws D, E, F and G holding door side hinges and replace at J, K, L and M as shown in illustration. Screws D, E, F and G should then be placed in positions M, L, K and J. **Note:** Hinges replaced diagonally, do this one at a time to avoid confusion.
- Replace the glass and inner panel and replace screws H and I. Place the handle into position and replace screws A, B and C. **Note:** If round door spacers at the handle have become dislodged, replace using the double sided tape provided. Replace all fibre washers.

- Transfer the door striker from the right '11' side to the left '10' side by interchanging the door striker and upper blanking screw only. Do not remove the adjacent lower screw fixings.
Place door on bottom hinge and place top hinge in position, tighten screws No. 5 and No. 6. Replace screw No. 8 and tighten screw No. 7.

- Some adjustment of the door striker may be necessary at this stage. With the door moved to a position where the door catch meets the striker, the striker must be located in the centre of the door catch aperture. If the striker does not locate centrally in the door catch, vertical adjustment may be obtained by slackening the door striker locknut and the posi-screw, then the striker can be moved up or down as required. With the door closed, the head of the striker must be fully engaged by the door catch. It is important after changing the door over, to check the door seal by closing the door onto a 2 in wide strip of paper (newspaper thickness), there should be resistance to the withdrawal of paper at all points around the seal, if the door seal does not grip the paper, or if it is too tight, adjustment can be obtained by slackening the locking nut on the striker and screwing it in or out as necessary then relocking the nut.

- Remove the 'door pull' sticker from its original position and reposition new sticker at the end of the handle away from the hinges.

- Open the door fully. Place padding under the door to support the door during the removal of the hinges.
- Unscrew screws and remove hinge and hinge shim at positions 1 and 2. Replace hinge at 5 and 6, replace hinge shim at 7 and 8. **Note:** The screws in the hinges should be removed and replaced one at a time. Only loosely fit screws No. 5 and No. 6 at this stage, to allow you to slot the door into position.
- Unscrew and remove hinge and hinge shim at positions 3 and 4. Replace hinge at 7 and 8, replace hinge shim at 5 and 6. **Note:** Replace steel washer on the lower hinge. Only loosely fit screw No. 7 at the top to allow you to slot the door into position. Retain screw No. 8 on one side for use later.
- Place the door on a flat surface.

Top Oven/Grill Cleaning
Clean grill pan and grid as soon after use as possible to prevent stains being burnt on when the grill pan is used again.

Wipe up any spillages as soon as possible to prevent them from being burnt on.

Cleaning the Exterior of the Cooker

The outside of the cooker should be cleaned regularly to keep it looking like new.

Wipe over with a soft cloth wrung out in hot water and dry with a soft clean cloth.

You can use mild non abrasive cleaners but always read the manufacturer's instructions first. Always test their suitability on a small area of the cooker not noticeable in normal use.

NOTE: DO NOT use scouring pads or abrasive cleaners which will scratch the glass.

Where protective gloves when cleaning any part of your cooker.

Replacement of the interior, main oven light

WARNING: BEFORE REPLACING THE OVEN LIGHT, SWITCH COOKER OFF AT THE COOKER CONTROL PANEL (and allow it to cool if it has been used).

Unscrew the glass cover and remove carefully ensuring that the metal washer is not mislaid. Unscrew the existing light bulb and remove. Screw the new bulb into position and replace the glass cover, with metal washer, until positioned securely.

The cooking systems in your Cooker

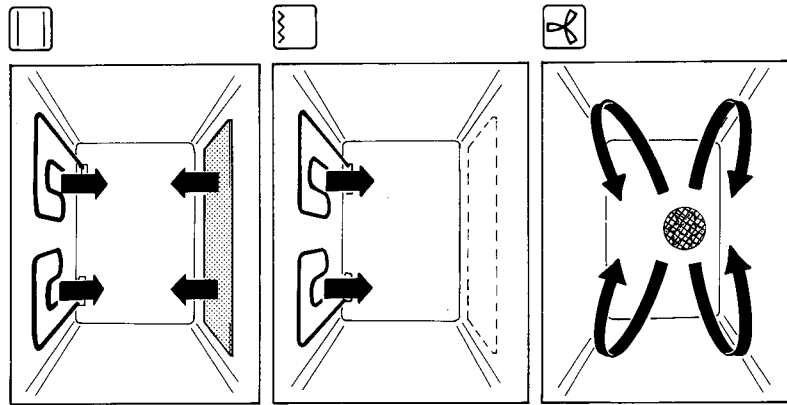

Your new cooker is equipped with three different cooking systems:

1. **Conventional Heating** [Top Oven] – with upper and lower heat. This system is particularly suitable for roasting and baking on one shelf only.

2. **Variable Grilling** [Top Oven] – the oven can also be used for conventional grilling with a full or half width fully controllable grill.
Note: The Top Oven Door should be open when grilling.

3. **Fan Cooking** [Main Oven] – the fan oven operates by constantly blowing heated air, from an element wrapped around the fan, into the oven. This gives improved efficiency and, in general, enables the use of lower temperatures for cooking. It also means that there is less need to be particular about shelf positions and that you can bake at more than one level simultaneously (Batch Baking).

These three systems of cooking are described more fully in the separate Recipe Book and we would suggest you read right through the Introductory Section of that book **before** using the oven.

PLEASE NOTE that when the cooker is used for the first time a slight odour may be emitted due to the 'burning off' of any temporary finish on oven fittings and elements and the removal of moisture absorbed by the lagging. The odour will cease after a short period of use. Ensure that the room is well ventilated (eg open a window or door) and that persons who may be sensitive to the odour avoid any fumes. It is suggested that any pets be removed from the room until the 'new smell' has ceased.

To remove, open the top and main oven door fully and, using a coin or screwdriver, turn the two discs anti-clockwise to the position shown below (Fig. a). Part close the door to approx. 45°, unhook the lower hinge fingers upwards, then pull the door away from the body of the cooker.

To replace, insert the lower fingers and hooked ends of the door stays, ensuring that the slots in the lower fingers engage with the front frame (Fig. b). Fully open the door and turn the discs clockwise to their normal working positions (Fig. c).

NOTE: Take care not to trap your fingers. Ensure that assistance is at hand should it be required.

Wipe over with a soft cloth wrung out in hot soapy water and dry with a soft clean cloth. Wear protective gloves. **DO NOT** use scouring pads or abrasive cleaners as they may scratch the surface.

Oven Interiors

To clean the oven interiors remove all the oven fittings and if necessary the 'Stay Clean' liners.

All types of oven cleaners can be used, but **do not** allow abrasive cleaners or oven spray to come into contact with the 'Stay Clean' liners. Use a fine steel wool soap pad to remove stubborn stains.

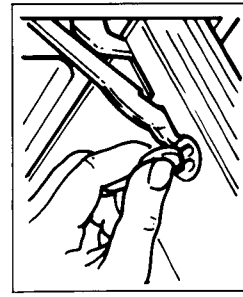

Fig. a

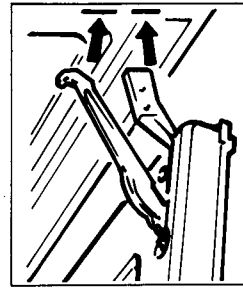

Fig. b

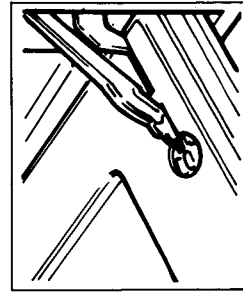

Fig. c

Care and Cleaning of the Oven

WARNING: BEFORE CLEANING SWITCH THE COOKER OFF AT THE COOKER CONTROL PANEL AND ALLOW IT TO COOL. IT IS ESSENTIAL THAT OVENS ARE CLEANED AND KEPT FREE FROM FATS; OIL AND GREASE.

'Stay Clean' Liners

'Stay Clean' liners are fitted to the sides of the Top Oven, and to the roof, sides and back of the Main Oven. All the liners except the roof panel of the Main Oven can be removed to be cleaned and to allow cleaning of the oven.

'Stay Clean' liners are covered with a special enamel which absorbs cooking soils. At higher temperatures the soiling is slowly destroyed. In most cases normal cooking at higher temperatures will permit this cleaning to take place automatically.

However, if higher cooking temperatures are not used regularly then it may be necessary, in order to prevent heavy soiling, to run the oven at maximum temperature for at least two hours, from time to time.

Should it be necessary, the 'Stay Clean' sides and back panels can be removed by unscrewing each panel.

The 'Stay Clean' liners can then be washed in warm soapy water followed by rinsing in clear water. Dry well with a soft cloth.

NOTE: Do not use enzyme washing powder, harsh abrasives or chemical oven cleaners of any kind.

Do not wash them in a dishwasher.

Oven Fittings

The shelves can be removed for cleaning either in a dishwasher or by using a fine steel wool soap pad.

The grill and meat pans can be cleaned either in warm soapy water using a fine steel wool soap pad to remove stubborn stains or in a dishwasher. They should be cleaned after each use.

Oven Door Cleaning – Main Oven

The inner door glass panel on the Main Oven can be removed for easy cleaning as follows:

- Open the door fully.
- Unscrew the two retaining screws taking care not to lose the two washers fitted underneath the screw head. Also take care not to drop the glass as you are taking it off.

The glass can now be cleaned at the sink. Stubborn stains can be removed with a fine steel wool soap pad.

After cleaning, rinse and dry with a soft cloth and refit the door:

NOTE: DO NOT use scouring pads or abrasive powder which will scratch the glass.

Take particular care when cleaning the inner surface which is coated with a heat reflecting surface.

- Make sure that the face marked 'IMPORTANT. This Face Towards Oven' is facing inwards.
- Refit the two screws with the two washers. Do not overtighten the screws.

WARNING: DO NOT RUN THE OVEN WITHOUT THE INNER DOOR GLASS PANEL FITTED.

Oven Door Cleaning – Top Oven/Grill

The Top Oven door is removable to facilitate the occasional cleaning of heavy soiling from the oven floor and from the door itself.

The Controls

Switch on the electricity supply to the cooker at the Cooker Control Unit.

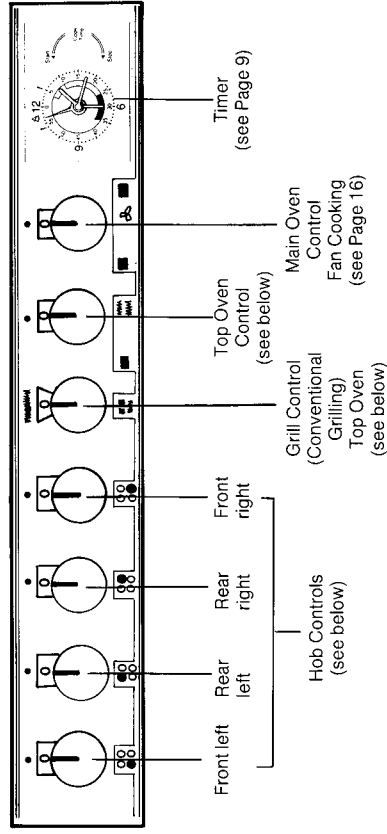

Hob Controls

As each control knob is turned clockwise figures from Lo, 1-5 then Hi appear in the window above the control knob.

Setting Hi is the highest/hottest and gives 100% power. Setting Lo is the lowest/coolest and gives about 7% power (see page 11 for ratings).

Variable power is obtainable on each of the heating areas by selecting any number between Lo, 1-5 then Hi. The 'off' position is identified by a red 'O'.

The control knobs for the hob heating areas can be rotated in either direction to provide fully variable heat control.

Grill Control – Top Oven

The grill will not operate unless the top oven control is in the 'O' off position.

The grill control provides fully variable heat control for either the

twin grill or single (left hand side) grill by selecting any number between 1 to 4 and Hi.

When turned clockwise the twin grill will be switched on and any power setting from 1 to 4 and Hi can be selected. The power level numbers are indicated in black on red background. When turned anti-clockwise the single grill will be switched on and any power level from 1 to 4 and Hi can be selected. The power level numbers are indicated in black on green background. The 'off' position is identified by a red 'O'.

Top Oven Control

This control switches on the top and bottom heating elements in the top oven.

The temperature in the top oven can be set anywhere between 100°C and 220°C.

The red thermostat light will glow initially and remain on until the oven

Temperature Conversion Chart

- operation (see page 10).
- The oven shelf in the top oven can be removed and used in the main oven if required.
 - To remove the oven shelves – pull the shelf towards the user until the 'arrest' position is reached.
Lift the shelf slightly and withdraw. To replace – lift the shelf and ensure that the shelves are firmly in position between the shelf runners. Lower the shelf and push into position.

reaches the required temperature. It will then cycle off and on as the oven thermostat maintains the correct temperature.
The 'off' position is identified by a red 'O'.
The top oven control can only be turned clockwise.

Main Oven Control

This control switches on the Main Oven and is also used to select the Fan Cooking option.

1. To select Fan Cooking:

Turn the control clockwise and select any temperature between 70°C and 230°C.
As the control is turned the fan will start, the oven interior light and the red Main Oven thermostat light will come on and the element around the fan will start heating. The fan and oven interior light will remain on throughout cooking. The red thermostat light will come on and remain on until the oven reaches the required temperature. It will then cycle off and on as the oven thermostat maintains the correct temperature.

Notes

- Never** operate **both** the top oven grill control and top oven control together. The grill will not operate unless the top oven control is in the 'O' off position.
- When the main oven door is opened a switch automatically disconnects the fan and heating element. These are reconnected when the door is closed.
- If either oven does not switch on when the control is turned check that the timer is in Manual

Conventional Electric		Slot-In Fan Mode	Gas Mark
°F	°C	°C	
200°	100°	80°	1/4
225°	110°	90°	1/4
250°	130°	110°-120°	1/2
275°	140°	120°	1
300°	150°	130°-140°	2
325°	160°	140°	3
340°-350°	170°-180°	160°	3-4
350°-375°	180°-190°	160°-180°	4-5
375°-400°	190°-200°	170°-190°	5-6
400°-440°	200°-225°	190°-200°	6-7
450°-500°	230°-250°	210°-220°	8-9

Temperatures

The recommended temperatures given are for conventional and fan ovens. When using a fan oven it will be necessary to reduce the cooking time by 10 minutes per hour, and lower the temperature by up to 30°C. Also, in the majority of cases, it is not necessary to pre-heat the oven. However, pre-heating is recommended when cooking items which require less than 25 minutes cooking time and such items as Yorkshire puddings, whisked sponges and bread. Your experience with the cooker will enable you to select the cooking time and temperature best suited for your recipe.

Condensation

Condensation may become evident on the inner door and water may drip through the vent. This is normal when heat and moisture are present and may be a result of any of the following:

- Kitchen temperature and ventilation.
- The moisture content of the food eg meat, roast potatoes, Yorkshire pudding, roasting meat, etc.
- The quantity of the food being cooked at any one time.

Main Oven – Fan Cooking

The heat for Fan Cooking in the Main Oven is provided by an element situated at the back of the oven, around the fan.

Fan cooking is ideal for large poultry or joints of meat, reducing cooking times and often eliminating the need for preheating the oven. It is also ideal for batch cooking where food is cooked on more than one level, because the forced circulation of hot air gives an even temperature from the top to the bottom of the oven.

The operation of the controls is covered on pages 7 and 8. Detailed charts covering suggested temperatures and shelf positions for Fan Cooking are given in the recipe book supplied.

To use the oven proceed as follows:

- Set the Main Oven control to the required temperature. Pre-heating is not normally necessary, but some foods such as bread, scones and Yorkshire pudding do benefit from being placed in a hot oven (see recipe book supplied).
- Place the food to be cooked in the centre of each shelf to allow for even air circulation around the food.
- When roasting use the anti splash tray beneath the meat to avoid excessive splashing of the oven.

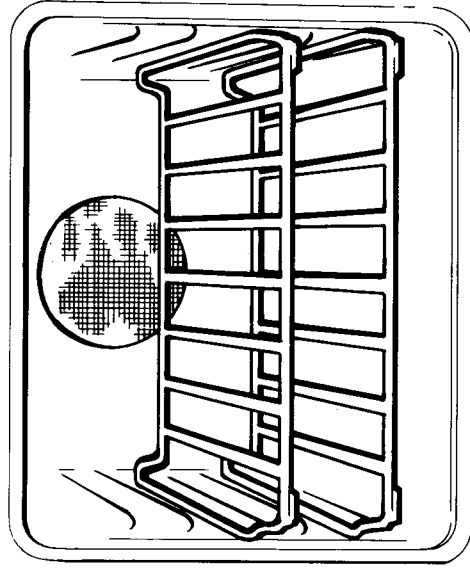

The Timer and its operation

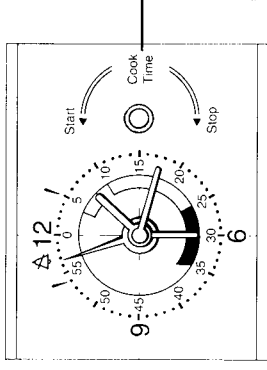

Outer knob – clockwise
Cooking completion time
Outer knob anti-clockwise
Cooking duration

The Timer can be used to automatically switch on either oven independently or both ovens simultaneously. It can also be used as a minute minder and clock.

Hints on Automatic Cooking

1. Select foods which will take about the same time to cook, and require approximately the same oven temperature.
2. Foods which discolour should be protected by coating in cooking oil, or tossing in water to which lemon juice has been added.
3. Foods should be well sealed in dishes, to prevent the loss of liquid during cooking. Aluminium foil makes a good seal.

Switching On – manual operation

1. Make sure the cooker is switched **On** at the main cooker control unit.
2. Check that the timer is showing the correct time of day.

1. **Setting Time of Day**
Push in the small inner knob and turn clockwise or anti-clockwise as required.

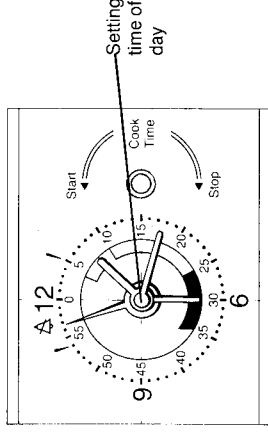

2. **Setting on Automatic Cooking Programme**
Setting cooking completion time

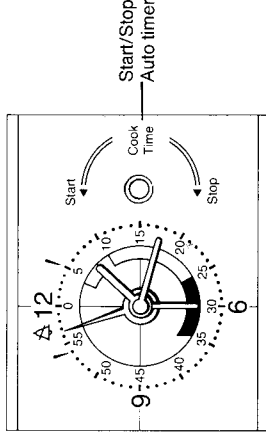

Turn the larger outer knob clockwise until the smaller circular stud is opposite the required end time. A maximum end time of up to 11 hours ahead and a minimum end time of 30 mins ahead can be set.

Top Oven – Conventional Cooking

Setting cooking duration

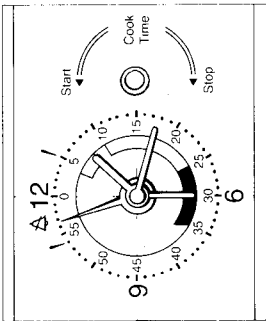

Turn the larger outer knob anti-clockwise. The red arc will appear on the clockface. Turn the knob until the required duration has been set. The start of the red arc denotes the cooking start time. Whilst the cooking programme is running, the red arc turns back with the hour hand, slowly disappearing. At the end of the cooking programme, the symbol 'O' appears in the window.

To reset the timer to Manual

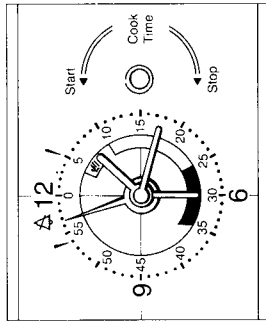

To reset the timer to manual operation, turn the larger outer knob until the hand symbol appears in the window.

Note: The maximum cooking duration which can be set is 3 hours.
IMPORTANT: Before using your oven for non-automatic timed cooking, ALWAYS make sure that the timer has been set to MANUAL operation (see paragraph above). Unless this is done the oven

cannot heat up. Before seeking assistance, make sure you have done this.

3. Minute Minder

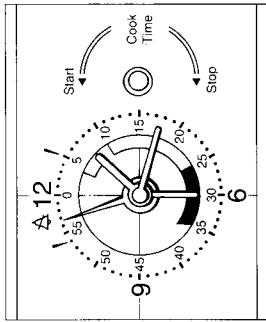

The minute minder operates independently from the automatic cooking programme. Turn the small inner knob (without pushing in) clockwise or anti-clockwise and set the time required up to 55 minutes. When the time set has elapsed there is an audible signal, which can be stopped by turning the knob to the symbol 'bell off'.

Before setting commences, the red pointer should always be in the 'bell off' position.
 Point to note: When one oven is set to operate on the automatic cooking programme the other oven cannot be used manually.

The heat for conventional cooking in the Top Oven is provided by the grill element and the element under the floor of the oven. It is ideal for the slow cooking of cheaper cuts of meat in casseroles etc but can also be used for small joints of meat up to 1.5kg (3lb).

The operation of the controls is covered on pages 7 and 8.

Detailed charts covering suggested temperatures and shelf positions for cooking are given in the recipe book supplied.

The Top Oven can be used either independently to cook small quantities of food or in conjunction with the Main Oven to provide additional cooking space.

To use the oven proceed as follows:

- The shelf should be positioned in the first or second runner from the bottom.
- Set the Top Oven control to the required temperature and wait for the thermostat light to go off indicating that the oven has reached the right temperature.
- The food to be cooked should be placed in the centre of the shelf with a gap of at least 25mm (1 in) between it and the grill element. This should avoid burning and ensure even cooking.

- **Do not place food or dishes on the floor of the oven.**

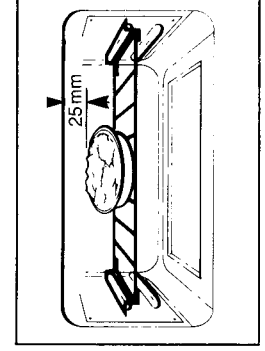
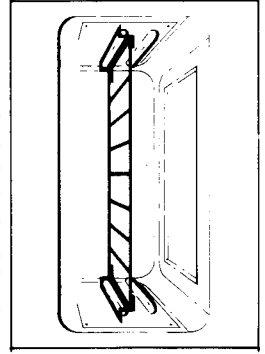

Platwarming in the Top Oven
 Plates and dishes placed on the floor of the Top Oven will be heated when the Main Oven is in use. When the Main Oven is not in use (for instance when a meal is being cooked on the hob) place the plates and serving dishes on the shelf using the lower runner, and turn the Top Oven control to approximately 100°C. A maximum time of 10-12 minutes is all that is required to heat the plates and dishes.

Do not operate the grill control when using the Top Oven for cooking or for warming plates and dishes.

WARNING: DO NOT PUT DELICATE CHINA OR ITEMS WHICH COULD BE AFFECTED BY HEAT INTO THE OVEN.

Top Oven – Grilling

Grilling must be done with the Top Oven door open. Control knobs may become hot during grilling. **CAUTION: ACCESSIBLE PARTS MAY BECOME HOT WHEN THE GRILL IS IN USE – CHILDREN SHOULD BE KEPT AWAY.**

The operation of the grill controls is covered on page 7. Remember that the grill will not operate until the Top Oven control is in the 'O' off position.

- To operate the grill proceed as follows:
- Open the Grill/Top Oven door.
 - When toasting or grilling, the rod shelf should be placed in either the first or second runner from the bottom.
 - Preheat the grill on setting HI for approximately 5 minutes, using either the half or full width setting depending upon the amount of food to be cooked (see page 7).

Fixing the grill pan handle.

Ensure that the handle is secure before use (see Figs. 1, 2 and 3 below). The food to be cooked should be placed on the grill pan/grill pan grid. Place the grill pan on the shelf and push back until the grill pan is correctly positioned beneath the grill element.

Fixing the Grill Pan Handle

The grill pan handle is detachable from the pan, to facilitate cleaning and storage. Fix the grill pan handle securely in position before use.

The handle fits onto the grill pan edge with the small recess, Fig. 1.

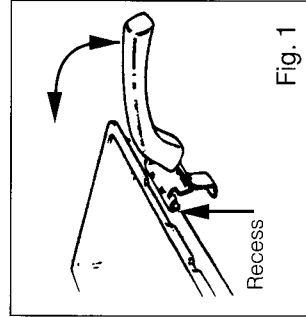

Fig. 1

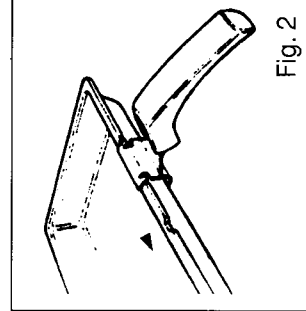

Fig. 2

Tilt the handle over the recess and slide it towards the centre, Fig. 2.

Ensure the handle is fully located, Fig. 3. Insert the washer and fixing screw and tighten fully to ensure handle is secured, Fig. 3.

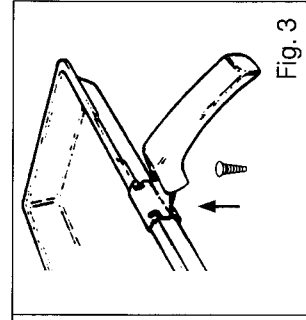
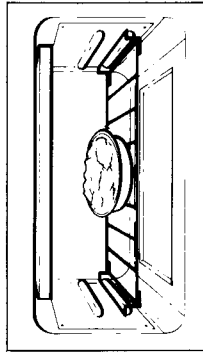
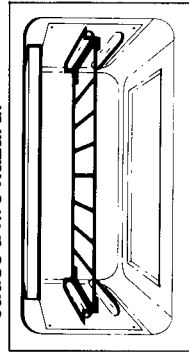

Fig. 3

- Food which only requires browning should be placed directly on the shelf in the first runner from the bottom.
- Leave the control on setting HI for toast and for the sealing and fast cooking of foods. For thicker foods requiring longer cooking turn the control to a lower setting after the initial sealing, on both sides, on setting HI. The thicker the food the lower the control should be set.

Warning: Take care as oven/grill will be hot – always wear oven gloves. Always ensure that the grill pan is clean BEFORE use. Excess fat build up in the bottom of the pan could cause a fire hazard.



Using the Ceramic Hob

WARNING: DO NOT USE THE HOB IF IT IS CRACKED. SWITCH OFF AT THE COOKER CONTROL PANEL IMMEDIATELY AND CONTACT YOUR NEAREST HOTPOINT SERVICE OFFICE (SEE BACK PAGE).

Ratings of Cooking Zones

Front Left
Halogen Speedglo plus 1800W
180mm diameter

Front Right
Speedglo 1200W
145mm diameter

Back Left
Speedglo 1200W
145mm diameter

Back Right
Speedglo 1800W
180mm diameter

The Working of the Heating Zones

Heating only occurs within the marked circular cooking zones. Each heating zone is equipped with a thermal limiter which is a safety cut-out which prevents the ceramic glass from overheating. After several minutes at full power the thermal limiter will switch the heating elements off and on automatically to avoid any damage to the ceramic glass.

Choice of Saucepans

It is essential that the saucepans you use on the ceramic hob are suitable.

DO USE:

- Good quality pans with smooth, flat, heavy bases.
- Saucepans manufactured from aluminium (enamelled or machined) or stainless steel.

- Correct size saucepans. The base of the pan must cover the heating zone completely.
- Saucepans with lids which are well fitting to reduce cooking time and energy use.

DO NOT USE:

- Pans with thin, distorted or uneven bases as these will extend cooking times, waste electricity and cause damaging, local hotspots on the glass surface.
- Pans with ridged or recessed bases.
- Pans with damaged or rough bases which could scratch the glass surface.

If detachable handle is required, do not insert screw fixing but retain screw and washer for possible future use.

Care of the Ceramic Hob

In order to keep your Ceramic Hob in good condition follow these simple guidelines:

- **Do not** use the surface for chopping and cutting as this will damage the smooth surface.
- **Do not** cook directly on the surface of the glass.
- **Do not** slide pans across the hob, as this could cause scratches. **Always** lift pans when moving them.
- **Do not** leave heating zones uncovered when they are on.
- **Do not** allow aluminium foil or plastic items to come into contact with the hot surface.
- **Do not** place anything between the saucepan base and ceramic glass surface (eg. cooking mats, etc).
- **Ensure** that the bottom of the pan is both clean and dry. Dirt or moisture between the pan and the hob can cause pitting of the surface of the glass.
- **Always** cover the heating zone completely with the saucepan.
- Clean spills immediately. (See below for advice.) If the hob is reused before cleaning, spillage will be baked on and be very difficult to remove.
- Take extra care when cooking foods with a high sugar content eg. jam as spillage will cause damage to the surface of the glass.

Cleaning the Ceramic Hob

Always switch the cooker **OFF** at the cooker control panel.

To minimise cleaning always

- Avoid spills.
- Use a Ceramic Hob Cleaner-Conditioner before using hob initially and subsequently whenever cleaning is done. The Cleaner-Conditioner forms a protective film on the hob and contains a mild detergent which makes cleaning easier. Hotpoint has a Cleaner-Conditioner which can be obtained either through a local Hotpoint Service Centre or retailer, part No. 6004.

To clean off stubborn stains the following can be used when the surface has cooled:

1. Jif, non-scratch cream cleaner.
2. Heavy soil can be shaved off the surface by **carefully** using a glass scraper.
3. Hard water stains, grease spots and any discolouration having a metallic sheen can be removed with Solvol Autosol Super or any **non abrasive** stainless steel cleaner.

After cleaning, always use the Cleaner-Conditioner and finish it off by polishing with a clean, dry paper towel.

Never use abrasive or chemical oven cleaners as they can damage the surface of the Hob.

The visual effect of any scratches which may occur in use can be minimised by the use of Cleaner-Conditioner. Such scratches cannot be removed but do not affect the function of the hob in any way.

Safety Requirements for

Deep Fat Frying

The following recommendations should be followed:

- a) **Never** leave the pan unattended on the heat, eg. to answer the telephone.
- b) Always use a deep pan large enough to cover the cooking zone.
- c) **Never** fill the pan more than one third full with oil or fat. On no account mix oil and fat.
- d) **Do not** overload the pan by trying to fry too much. The pan containing oil and food should **not** be more than two thirds full.
- e) Always dry food thoroughly before frying and lower it slowly into the oil.
- f) **Do not** use a lid on the pan.
- g) Always keep the outside of the pan clean and free from fat and oil.
- h) **Do not** allow excessive splashing of oil onto the hob.

In the event of fire follow these steps:

1. If a saucepan or chip pan catches fire **TURN OFF THE HEAT IF SAFE TO DO SO**, using the control on the front of the cooker.
2. **DO NOT** attempt to move the pan, this may cause the fire to spread to other areas.
3. **DO NOT** use **WATER** to put out the fire. If available use only an **APPROVED FIRE EXTINGUISHER** for the purpose, ie. **DRY POWDER, CO₂**, or **HALON**.

4. If a **FIRE EXTINGUISHER** is **NOT** available, smother the flames with a **DAMP CLOTH; SAUCEPAN LID** or **FIRE BLANKET**.

When smothering the flames **DO ENSURE** that your **FACE AND ARMS** are **WELL PROTECTED** from the flames to save you from becoming hurt.

5. After the fire has been extinguished **DO NOT MOVE OR TOUCH** the pan for at least 30 minutes.
6. If you **FAIL** to put the fire out call the fire brigade immediately.



Key Contacts

After Sales Service

Over 1100 trained specialists, directly employed by us, ensure that you have complete confidence in both the appliances and services we offer.

Repair Service

UK: 08709 066 066

(Open 8 to 8 Mon - Fri, 8 to 6 Sat & 10 to 4 Sun)

www.theservicecentre.co.uk

Republic of Ireland: 1850 302 200

Note: Our Service Operators will require the following information:

Model Number

Serial Number

Extended Warranties

UK: 08709 088 088

(Open 8 to 6 Mon - Fri)

www.theservicecentre.co.uk

Republic of Ireland: 1850 502 200

Genuine Parts and Accessories

UK: 08709 077 077

(Open 8-30 to 5-30 Mon - Fri, 8-30 to 12 Sat)

www.theservicecentre.co.uk

Republic of Ireland: (01) 842 6836