

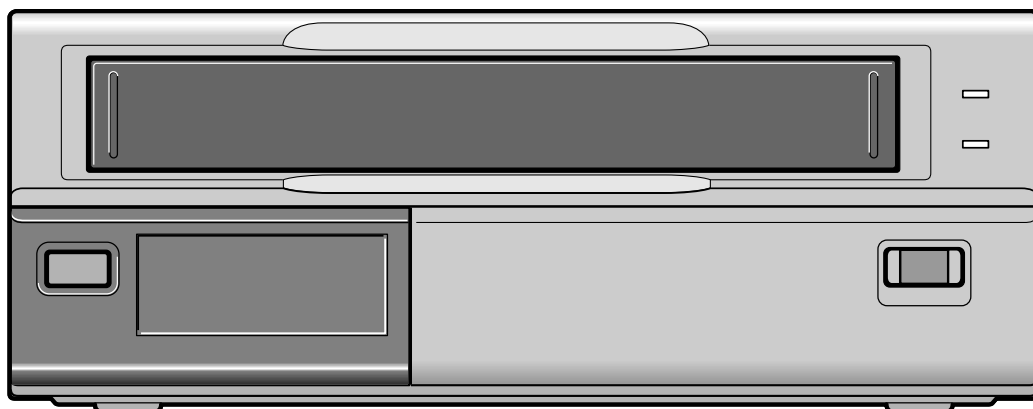

INSTRUCTION MANUAL

TLS-224P

Time Lapse Video Cassette Recorder	English	GB
Time Lapse Videorecorder	Deutsch	D
Magnétoscope time lapse à cassette	Français	F
Videograbador en lapsos de tiempo	Español	E
Videoregistratore a cassette, a fotogrammi differenziati	Italiano	I
时延录像机	中国简体	CS



PRECAUTIONS

WARNING: TO REDUCE THE RISK OF FIRE OR ELECTRIC SHOCK, DO NOT EXPOSE THIS APPLIANCE TO RAIN OR OTHER MOISTURE.

To avoid electrical shock, do not open the cabinet.

Refer servicing to qualified personnel only.

If the power supply cord (power cord) of this appliance is damaged, it must be replaced.

CAUTION: Do not put your hand or other objects in the cassette loading slot because of risk of injury or accident. Be sure to keep small children away from the VCR.

Location

For safe operation and satisfactory performance of your VCR, keep the following in mind when selecting a place for its installation:

- Shield it from direct sunlight and keep it away from sources of intense heat.
- Avoid dusty or humid places.
- Avoid places with insufficient ventilation for proper heat dissipation. Do not block the ventilation holes of the VCR. Do not place the unit on a carpet because this will block the ventilation holes.
- Install the VCR in a horizontal position only.
- Avoid locations subject to strong vibrations.
- Avoid moving the VCR between cold and hot locations (see "Moisture Condensation Problems", this page).
- Do not place the VCR directly on top of the TV, as this may cause playback or recording problems.

Avoiding Electrical Shock and Fire

- Do not handle the power cord with wet hands.
- Do not pull on the power cord.
- If any liquid is spilled on the VCR, unplug the power cord immediately and have the unit inspected at a factory-authorized service centre.
- Do not place anything directly on top of this VCR.

Moisture Condensation Problems

Cause:

When the VCR is first installed, moved from a cold area to a warm area or placed in a location with high humidity, dew (moisture) may form in the unit. The Dew indicator (d d d d) blinks. If you operate the VCR with dew inside, damage may result.

Prevention:

- 1 Make all necessary connections.
- 2 Plug the power cord.
- 3 Do not operate the VCR for approximately 2 hours.

When the VCR reaches room temperature, the Dew indicator (d d d d) will turn off and the VCR will be ready to operate.

Power on/stand-by mode

The power on/stand-by mode is selected by pressing the **STANDBY/ON** button.

VCR display

Stand-by mode

Power on mode



"Stand-by mode" is the condition in which only the time is displayed.

Do not forget that even in the stand-by mode there is an electrical voltage inside the VCR.

Disconnect the power cord if the VCR is not to be used for a long time.

Bij dit produkt zijn batterijen geleverd. Wanneer deze leeg zijn, moet u ze niet weggooien maar inleveren als KCA.

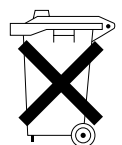

FEATURES

- Clog detection
- High-speed Fast forward/Rewind
- Field recording/playback
- 3, 12, 24-hour mode recording audio playback
- Autorepeat recording
- Alarm recording function
- On-screen mode setting
- Integrated time date generator
- Alarm scan function
- Forward field advance function
- 30-day memory backup
- Security lock
- Recording check function
- Head-cleaning function

What is Time-Lapse Video?

A standard VCR records 50 images (fields) per second, while this time lapse VCR can record at different rates. This feature makes it possible to record up to 27 hours on a single video tape. As a result, this unit is extremely useful for long-term monitoring or recording changes that take place slowly over an extended period of time (such as the blooming of a flower).

CONTENTS

PRECAUTIONS	1
FEATURES.....	2
LOCATIONS OF CONTROLS AND INDICATORS	3
CONNECTIONS	6
TYPES OF ON-SCREEN DISPLAYS AND DISPLAY SEQUENCE	7
SETTING THE LANGUAGE AND CLOCK	8
CHANGING THE ON-SCREEN DISPLAY	9
VIDEO CASSETTE TAPES	10
NORMAL RECORDING	11
AUTOREPEAT RECORDING.....	13
ALARM RECORDING.....	14
PROGRAMME TIMER RECORDING.....	17
RECORDING USING AN EXTERNAL TIMER INPUT	20
NORMAL PLAYBACK.....	21
SPECIAL PLAYBACK.....	22
SETTING THE SECURITY LOCK	23
SETTING THE BUZZER.....	23
CHECKING USAGE DURATION	24
CHECKING POWER FAILURE AND FAILURE DUE TO CONDENSATION	24
OUTPUT TERMINALS	25
MAINTENANCE	27
TROUBLESHOOTING GUIDE	28
SPECIFICATIONS	29

GB

LOCATIONS OF CONTROLS AND INDICATORS

Front Panel

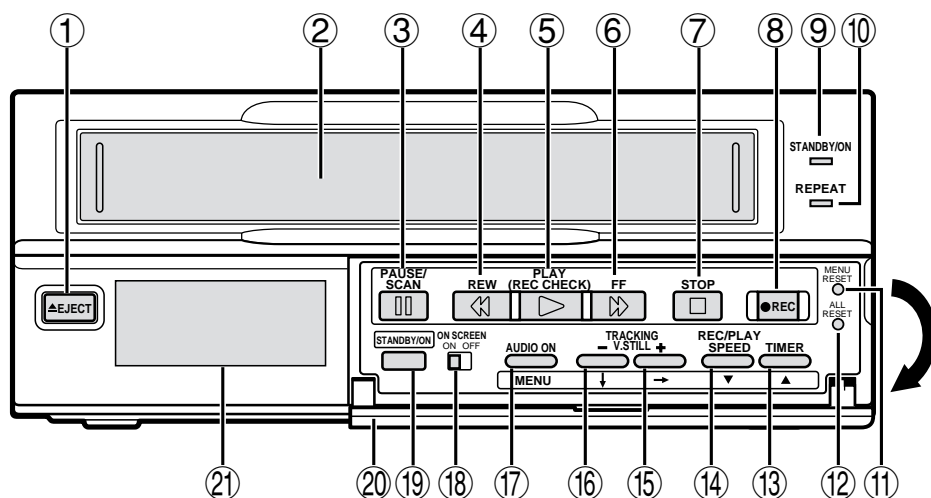

- ① **EJECT** button
- ② Cassette loading slot
- ③ **PAUSE/SCAN** button
- ④ **REW** (rewind/review) button
- ⑤ **PLAY (REC CHECK)** button
- ⑥ **FF** (fast forward/cue) button
- ⑦ **STOP** button
- ⑧ **REC** (record) button
- ⑨ **STANDBY/ON** LED
- ⑩ **REPEAT** LED (autorepeat recording indicator)
- ⑪ **MENU RESET** button
- ⑫ **ALL RESET** button
- ⑬ **TIMER** button
- ⑭ **REC/PLAY SPEED** button
(recording/playback speed)
- ⑮ **TRACKING/V. STILL +** button
- ⑯ **TRACKING/V. STILL -** button
- ⑰ **AUDIO ON/MENU** button
Press this button to display the menu.
Buttons ⑬, ⑭, ⑮ and ⑯ are used for menu control.
- ⑱ **ON SCREEN** switch
- ⑲ **STANDBY/ON** button
- ⑳ Front door
- ㉑ Digital display panel

GB

LOCATIONS OF CONTROLS AND INDICATORS

Digital Display

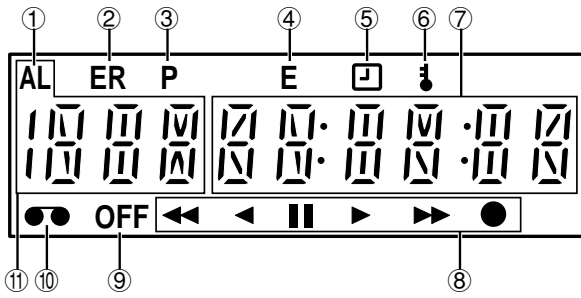

① Alarm indicator

Flashes when an alarm is being recorded:



Comes on after the alarm has been recorded:

AL

② Error indicator **ER**

Comes on in case of a problem

③ Power failure indicator **P**

Comes on after a power failure.

④ External input indicator **E**

Comes on when recording using the **EXT TIMER IN** input terminal.

⑤ Timer Recording indicator

Comes on when in timer recording stand-by mode, or during a timer recording.

⑥ Security lock indicator

Comes on when the security lock is engaged.

⑦ Counter display

• Time display

00:00

• Linear time counter display





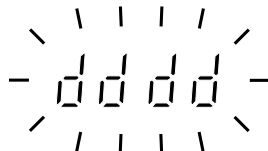



0:00:00

• Dew display



⑧ Operation Indicators

• They display the actual operation mode.

Operation Mode	Indicator
Record (REC)	●
Record pause (REC PAUSE)	● + 
Playback (PLAY)	
Still image (STILL)	
Fast forward (FF)	
Rewind (REW)	
Cue (CUE)	
Review (REVIEW)	
Field shift forward (FIELD SHIFT +)	

• Clog detection indicator 

Flashes when the recording quality deteriorates due to dirty VCR heads.

⑨ OFF indicator **OFF**

Comes on when the tape end has been reached after a recording, except during autorepeat recording mode.

NOTE:

• The buzzer will be heard as long as "OFF" is displayed on the digital display.
To cancel the "OFF" display, press the **EJECT**, **PLAY**, **STOP**, **FF** or **REW** button.

⑩ Cassette indicator

Comes on when a cassette is loaded.

⑪ Mode display

• Recording/playback speed mode

24

• Alarm scan mode

AL
518

GB

LOCATIONS OF CONTROLS AND INDICATORS

Back Panel

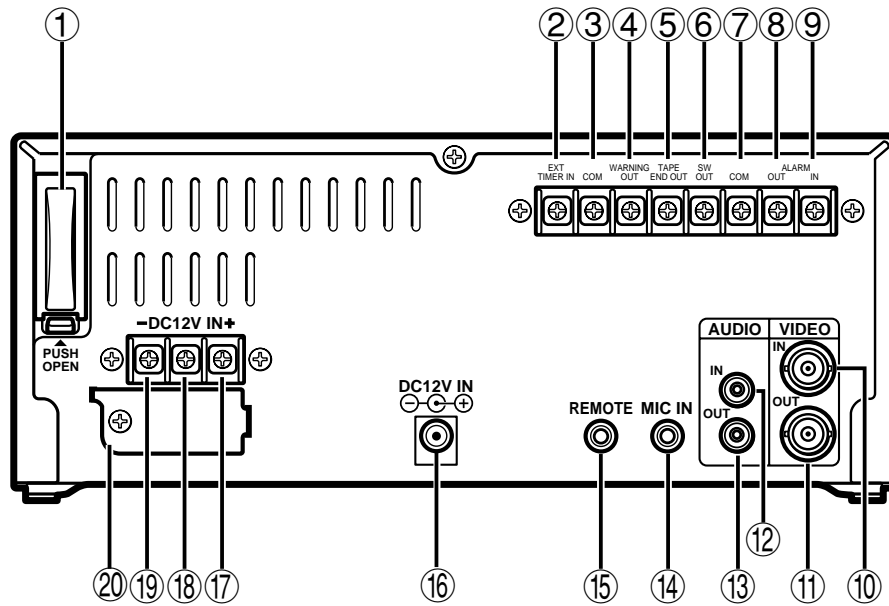

- | | |
|--|---|
| <ul style="list-style-type: none"> ① Battery compartment cover ② EXT TIMER IN (external timer input) terminal ③ COM (common) terminal ④ WARNING OUT (warning output) terminal ⑤ TAPE END OUT (tape end output) terminal ⑥ SW OUT (switch output) terminal ⑦ COM (common) terminal ⑧ ALARM OUT (alarm output) terminal ⑨ ALARM IN (alarm input) terminal | <ul style="list-style-type: none"> ⑩ VIDEO IN (video input) jack ⑪ VIDEO OUT (video output) jack ⑫ AUDIO IN (audio input) jack ⑬ AUDIO OUT (audio output) jack ⑭ MIC IN (microphone input) jack ⑮ REMOTE (remote control input) jack ⑯ DC 12 V IN (DC 12 V input) jack ⑰ DC 12 V IN “+” input terminal ⑱ Do not use ⑲ DC 12 V IN “-” input terminal ⑳ Fuse cover |
|--|---|

NOTES:

- This terminal board may be damaged by 5 kg-cm or more torque and using $\phi 6$ mm-tip or more size screwdrivers.
- Pay attention to the polarity of the DC 12 V input terminal (“+”: red screw, “-”: black screw).
- When both the DC 12 V IN jack and the DC 12 V IN terminals are connected, the input with the highest voltage will have priority.

CONNECTIONS

Connect the video camera and monitor TV as shown in the figure below.

NOTE: Before making the connections, make sure all the devices are disconnected from the DC power supply.

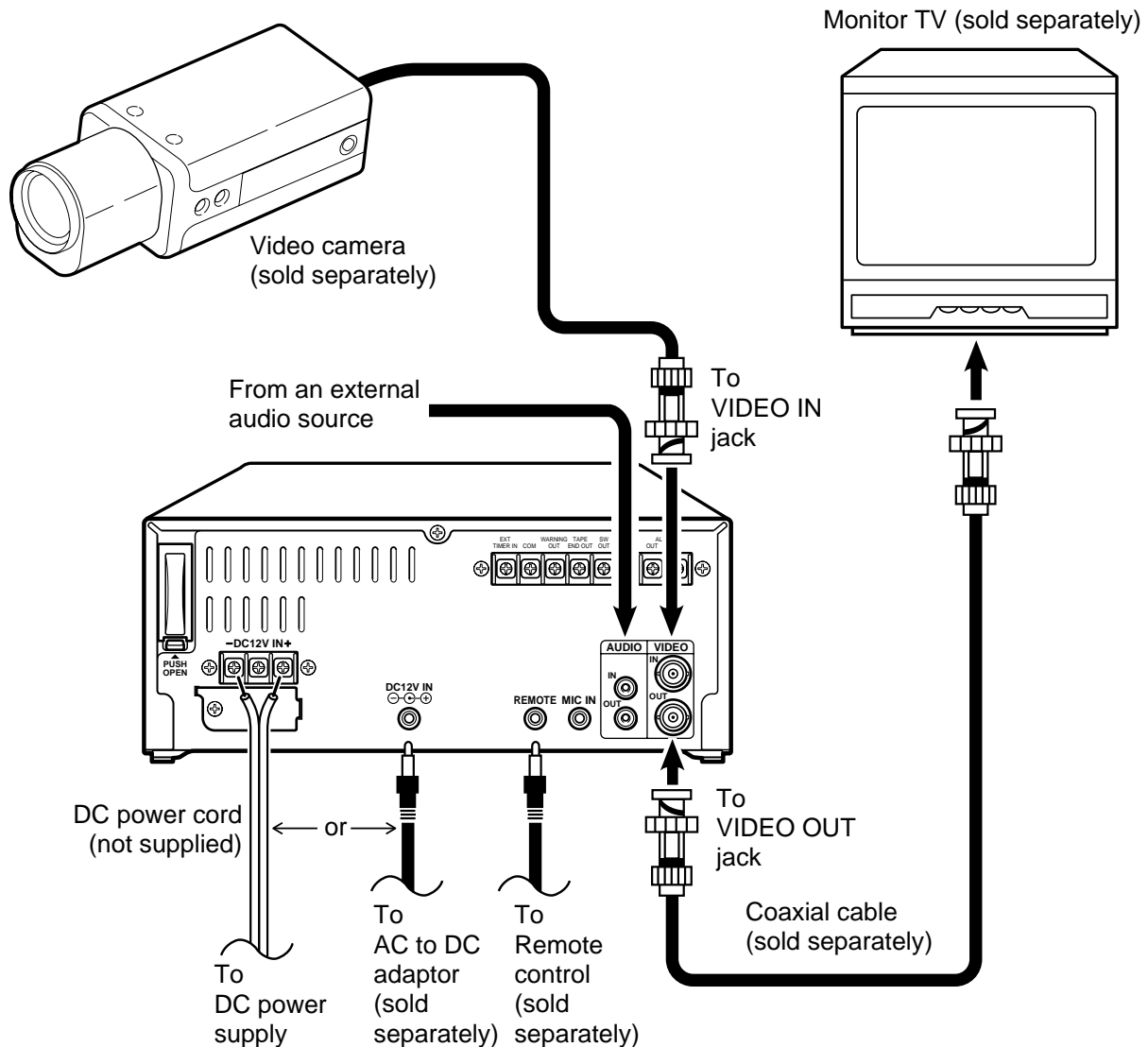

About the memory reset

If the VCR location is changed or to cancel previous settings, please reset the memory as described below.

The time and date will be reset.

To reset the memory, press the **ALL RESET** button.

NOTES:

- For more details, please refer to the manuals accompanying all other devices. If the connections are not made properly, it may cause a fire or damage the equipment.
- Use a DC power cord rated A.W.G 16 (1.3 mm²) or more, of a maximum length of 6 m.
- The DC power supply source should be able to supply 8 A or more. If the power supply is not sufficient, the VCR may not operate properly.
- You can use a VA-RMN01 Remote Control Unit (sold separately) to control remotely the VCR.

GB

TYPES OF ON-SCREEN DISPLAYS AND DISPLAY SEQUENCE

NOTES:

- When a menu is displayed, recording will not be possible.
- Press the **PAUSE/SCAN** or **AUDIO ON/MENU** button, the setting procedure is now completed.
- During recording or playback the menus cannot be displayed.
- To reset the settings of a menu to their original values, select the desired menu then press the **MENU RESET** button. The (USED TIME) menu data cannot be reset.
- To enter the settings use the ↓, →, ▼ or ▲ buttons.

GB

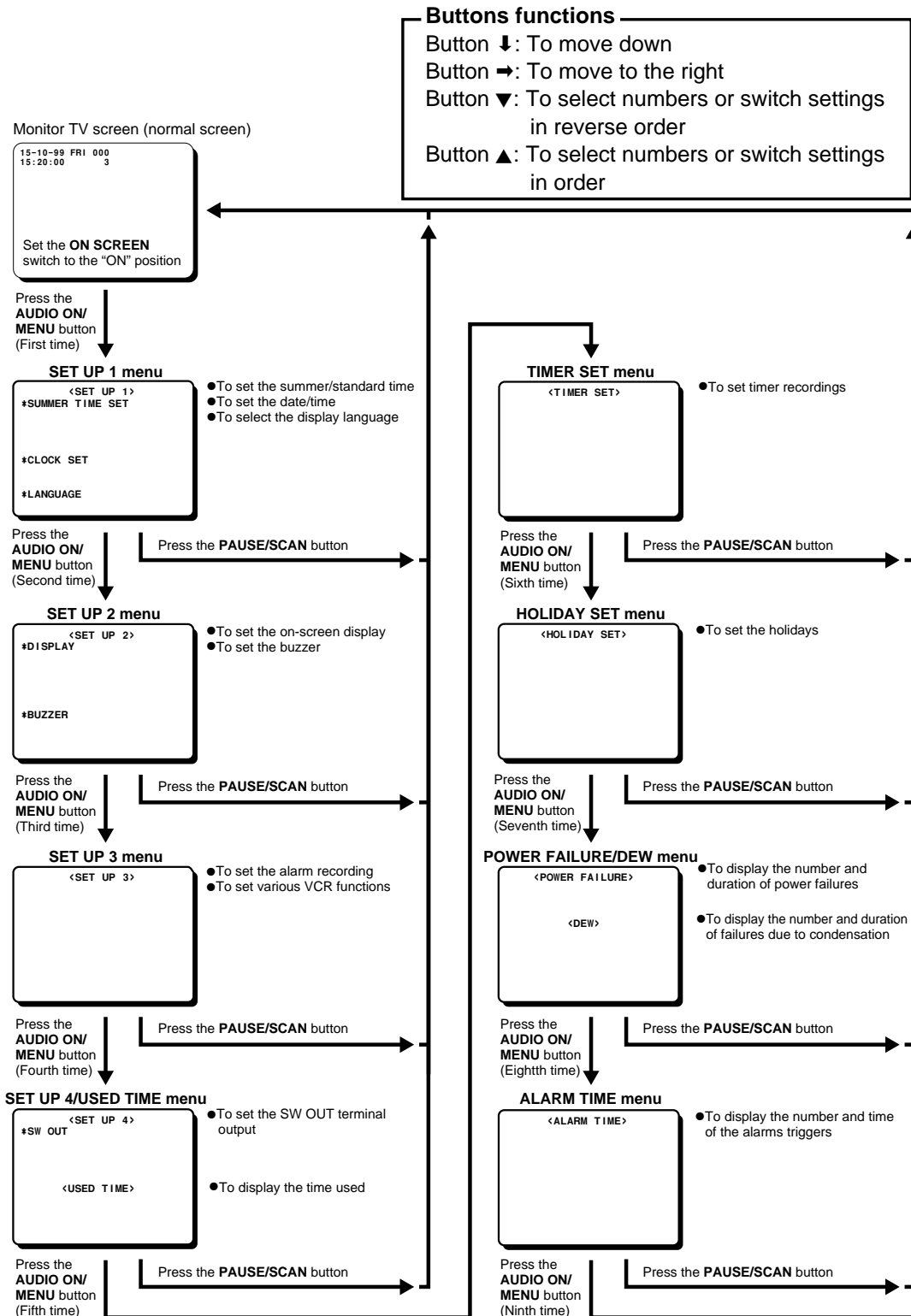

SETTING THE LANGUAGE AND CLOCK

Language Setting

English, French or German can be selected by the user.

- ❶ Turn the power on to all devices used.
- ❷ Press the **AUDIO ON/MENU** button to display the (SET UP 1) menu.

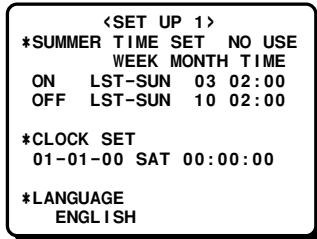

- ❸ Press the ↓ button, until "ENGLISH" is flashing.
- ❹ Press the ▼ (or ▲) button to select the language of your choice.
- ❺ Press the **PAUSE/SCAN** button to save the settings.

Clock setting

Example: To set the clock to October 15, 1999 at 3:20 PM (15:20).

- ❶ Press the **AUDIO ON/MENU** button to display the (SET UP 1) menu.
- ❷ Press the ▼ (or ▲) button, to set the auto summer time/standard time adjustment.

NO USE No summer time/standard time adjustment made.
 USE The auto summer time/standard time adjustment is made.

- ❸ Press the ↓ button.
- ❹ Set the day the summer time adjustment is made.
 - Press the ▼ (or ▲) button to set the week, then press the → button.
 1ST, 2ND, 3RD, 4TH or LST (first, second, third, fourth or last)
 - Press the ▼ (or ▲) button to set the day of week, then press the → button.
 SUN, MON, TUE, SAT (Sunday, Monday, Tuesday....Saturday)
- ❺ Press the ▼ (or ▲) button to set the month the summer time adjustment is made, then press the → button.
 01, 02,.....11, 12 (for January, February.....November, December)
- ❻ Press the ▼ (or ▲) button to set the time the summer time adjustment is made.
- ❼ Press the ↓ button.

- ❽ Following the same procedure as above (steps ❹ to ❻), set when the time is changed back from summer time to standard time.
- ❾ Press the ↓ button.
- ❿ Press the ▼ (or ▲) button to set the day (ex: 15), then press the → button.
 - *The day of week is set automatically.*
- ⓫ Press the ▼ (or ▲) button to set the month (ex: 10), then press the → button.
- ⓬ Press the ▼ (or ▲) button to set the year (ex: 99 for 1999), then press the → button.
 - *The last 2 digits only are displayed.*
- ⓭ Press the ▼ (or ▲) button to set the hours (ex: 15 for 3 PM), then press the → button.
- ⓮ Press the ▼ (or ▲) button to set the minutes (ex: 20), then press the → button.
- ⓯ For accurate clock setting, press the ▼ button timed with a time broadcast, or other accurate time signal, this will start the seconds counting from 00.

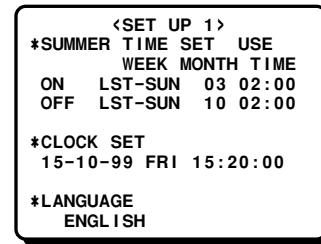

- ⓰ When finished, press the **PAUSE/SCAN** button to save the settings.

GB

CHANGING THE ON-SCREEN DISPLAY

Selecting the On-screen Display

You can select to display or not the date, time, the number of alarm triggers and tape speed.

- 1 Turn the power on to all devices used.
- 2 Press the **AUDIO ON/MENU** button until the (SET UP 2) menu is displayed.

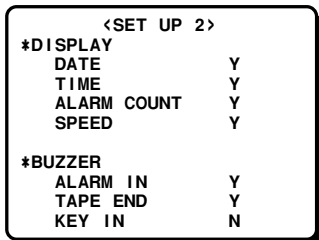

- 3 Press the ↓ button, until the desired item for which the display function will be set is flashing.
- 4 Press the ▼ (or ▲) button to set “Y” for the functions described below.
 - DATE The date is displayed
 - TIME The time is displayed
 - ALARM COUNT . . The number of alarm triggers is displayed
 - SPEED The recording/playback speed is displayed
- 5 Press the **PAUSE/SCAN** button, the normal screen is displayed.
 - *The setting procedure is now completed.*

NOTE:

- If the **ON SCREEN** switch is set to the “ON” position, the items for which “Y” is set are recorded. The items for which “N” was set at step 4 above are not recorded.

Changing the Date/Time Display Position

- 1 Turn the power on to all devices used.
- 2 Set the **ON SCREEN** switch to the “ON” position.
 - *The date and time are displayed.*

Date/Time display

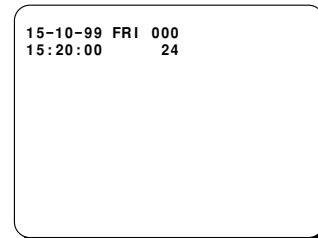

- 3 Press the → (or ↓) button.
 - *The display will move towards the right (or the bottom).*

NOTES:

- If the → (or ↓) button is kept pressed for 1 second or more the display will move at a faster speed.
- The display position cannot be changed while recording.

VIDEO CASSETTE TAPES

Use only video cassette tapes bearing the **VHS** logo. This VCR was primarily designed for use with E-180 cassette tapes, it is recommended to use E-180 VHS video cassette tapes for optimal performance.

Handling Cassette Tapes

The cassette tapes should always be stored vertically, in their cases, away from high temperatures, magnetic fields, direct sunlight, dirt, dust and locations subject to mold formation.

Do not tamper with the cassette mechanism and never touch the tape with your fingers.

Protect the cassette tapes from shocks or strong vibrations.

To Protect your Recordings

After having recorded a tape, if you wish to keep the recording, use a flathead screwdriver to break off the erasure-prevention tab on the cassette.

To record again on a tape without erasure-prevention tab, cover the hole with adhesive tape.

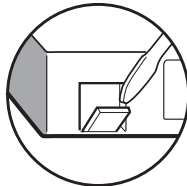
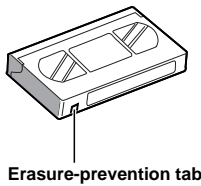

Loading

- 1 Place the cassette, label side up, in the loading slot. Gently push the centre of the cassette until it is loaded automatically.

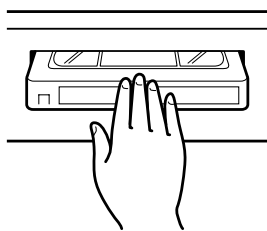

- When the cassette is loaded, the cassette indicator “●●” will light on the digital display.
- The time display will switch to the reset counter “0:00:00” display.

NOTE:

- If you try to record on a cassette without erasure-prevention tab, the VCR will eject the cassette.

Unloading

- 1 In STOP mode, press the **EJECT** button.
 - The cassette is automatically ejected.

NOTES:

- Do not insert any object in the cassette loading slot, as that may cause injury and damages to the VCR.
- If your hand gets stuck in the cassette loading slot, unplug the power cord and consult the dealer where the unit was bought. Do not forcibly pull the hand out as that may cause severe injuries.

Setting the Action to Take When a Cassette is Loaded

In the (SET UP 3) menu, you can set the mode the VCR will go into when a cassette is loaded.

- 1 Press the **AUDIO ON/MENU** button until the (SET UP 3) menu is displayed.

<SET UP 3>	
ALARM MODE	Y1
ALARM SPEED	3H
ALARM DURATION	20S
TAPE IN MODE	STOP
TAPE END MODE	REW
TAPE END OUT	-3M
CLOG DETECT.	Y

- 2 Press the **↓** button, until the “TAPE IN MODE” setting is flashing.
- 3 Press the **▼** (or **▲**) button, to set the desired mode.
 - STOP Stays in stop mode
 - REC Goes into recording mode
- 4 Press the **PAUSE/SCAN** button to save the setting.

GB

NORMAL RECORDING

Normal Recording

- ❶ Turn the power on to all devices used.
- ❷ Load a cassette tape with erasure-prevention tab.

NOTE:

- If in the (SET UP 3) menu, TAPE IN MODE is set to "REC", recording will start.

- ❸ Set the **ON SCREEN** switch to the "ON" position.
- ❹ Press the **REC/PLAY SPEED** button to set the recording speed.

- *The recording speed is displayed on-screen and on the digital display.*

- ❺ Press the **REC** button.

- *The Record indicator (●) lights.*
- *Recording starts.*

- ❻ To stop recording, press the **STOP** button.

NOTES:

- A tape recorded on this VCR cannot be played back on a time lapse VCR produced by another manufacturer.
- If you press on the **REC** button and the loaded cassette has no erasure-prevention tab, the VCR will eject the cassette.
- During recording, the **AUDIO ON/MENU** button will not function (the menu cannot be displayed).
- During recording, the tape speed cannot be changed.

[Recording Speed]

Recording speed	Maximum recording duration (with an E-180 cassette tape)	Recording interval	Audio recording	Tape motion
3	Standard mode	3 hours	Possible	Continuous
12	Time lapse mode	15		
24		27		
		1/50 second		
		0.1		
		0.18		

TAPE COUNTER NOTES:

- There is no tape counter indication for the blank portions of the tape.
- In the 3-hour recording speed mode only, the tape counter indicates real hours, minutes and seconds.
- In the other recording speed modes, the tape counter indication is a ratio of the 3-hour mode base indication. (In 12-hour recording mode, each "second" of the tape counter actually represents approximately $(12/3)+1 = 5$ real seconds.)
- There may be a slight discrepancy between the position shown on the tape counter and the actual tape position.
- When rewinding the tape past the "0:00:00" position, a minus (-) sign will be displayed.

Record Pause

Recording can be interrupted temporarily.

- ❶ Press the **PAUSE/SCAN** button during recording.
 - *The Pause/Still indicator (||) blinks.*

NOTES:

- The image appears on-screen but it is not recorded.
 - If a recording pause continues for 5 minutes or more, the VCR will go into stop mode to avoid damaging the tape.
- ❷ To resume recording, press the **REC** button, or press the **PAUSE/SCAN** button again.

NORMAL RECORDING

Recording Check

The image being recorded can be checked.

- ① During recording, press the **PLAY (REC CHECK)** button.
 - *The tape will be rewound and then played back. The VCR will then return to the previous recording mode.*

NOTE:

- During recording check operations, recording is suspended momentarily.

Clog Detection

This VCR is equipped with a clog detection function.

The recording quality is monitored automatically. When the heads are dirty and the recording quality deteriorates, the output at the WARNING OUT terminal becomes 0V (Low), the “●” indicator flashes on the digital display, and the buzzer sounds.

If in the (SET UP 3) menu, CLOG DETECT. is set to “N”, the recording quality is not monitored.

NOTES:

- To cancel the “●” indicator display and reset the WARNING OUT terminal output, press the **STOP** or **EJECT** button.
- Clog detection is not possible if recording in 3-hour recording mode.

AUTOREPEAT RECORDING

Autorepeat Recording

The same tape can be recorded over many times.

- 1 Press the **AUDIO ON/MENU** button until the (SET UP 3) menu is displayed.
 - The "ALARM MODE" setting is flashing.

<SET UP 3>	
ALARM MODE	Y1
ALARM SPEED	3H
ALARM DURATION	20S
TAPE IN MODE	STOP
TAPE END MODE	REW
TAPE END OUT	-3M
CLOG DETECT.	Y

- 2 Press the ↓ button, until the "TAPE END MODE" setting is flashing.
- 3 Press the ▼ (or ▲) button to set to "R 1" or "R 2". (See "Setting the Mode at the End of the Tape")
- 4 Press the **PAUSE/SCAN** button, the normal screen is displayed.
 - The REPEAT LED will light.
 - The setting procedure is now completed.
- 5 Press the **REC** button.
 - Recording will start. When the tape end is reached, the VCR will rewind it to the beginning, and recording will resume.

NOTES:

- If during autorepeat recording there is an alarm trigger, "AL" is displayed on the digital display and alarm recording will take place. (Please refer to page 14, "ALARM RECORDING".)
- If the "TAPE END MODE" setting is R 1, the REPEAT LED will go off if there is an alarm trigger. The recording will continue to the end of the tape then it will be rewound to the beginning and stop. "OFF" will be displayed on the digital display.

Setting the Mode at the End of the Tape

In the (SET UP 3) menu, you can set the mode of the VCR mode when the tape reaches the end during recording.

- 1 Press the **AUDIO ON/MENU** button until the (SET UP 3) menu is displayed.

<SET UP 3>	
ALARM MODE	Y1
ALARM SPEED	3H
ALARM DURATION	20S
TAPE IN MODE	STOP
TAPE END MODE	REW
TAPE END OUT	-3M
CLOG DETECT.	Y

- 2 Press the ↓ button, until the "TAPE END MODE" setting is flashing.
- 3 Press the ▼ (or ▲) button, to set the desired mode.
 - REW. Rewinds the tape to the beginning, then goes to stop mode
 - STOP Goes to stop mode
 - EJECT The cassette is ejected
 - R1. The autorepeat mode is automatically canceled if there was an alarm trigger
 - R2. Autorepeat mode is active even if there was an alarm trigger
- 4 Press the **PAUSE/SCAN** button to save the setting

GB

ALARM RECORDING

By connecting the **ALARM IN** terminal to a door switch, an interphone, etc., a recording can be done only when necessary.

Alarm Recording Setting

Alarm recording is performed when there is an input (trigger) at the **ALARM IN** terminal, "AL" is displayed on the digital display.

- 1 Make all necessary connections.
- 2 Press the **AUDIO ON/MENU** button until the (SET UP 3) menu is displayed.
 - o The "ALARM MODE" setting is flashing.

<SET UP 3>	
ALARM MODE	Y1
ALARM SPEED	3H
ALARM DURATION	20S
TAPE IN MODE	STOP
TAPE END MODE	REW
TAPE END OUT	-3M
CLOG DETECT.	Y

- 3 Press the ▼ (or ▲) button to set the desired alarm mode, then press the ↓ button.
 - Y1 Alarm recording is done when there is an alarm trigger.
 - Y2 Alarm recording is done only when there is an alarm trigger during programmed timer recording.
 - Y3 Alarm recording is done only if there is an alarm trigger and the VCR is not in programmed timer recording mode.
 - N Alarm recording is not performed even if there is an alarm trigger.
- 4 Press the ▼ (or ▲) button, to set the desired alarm recording speed, then press the ↓ button.
 - 3H 3-hour mode recording
 - 12H 12-hour mode recording
 - NC Recording at the speed already set

- 5 Press the ▼ (or ▲) button, to select the desired alarm recording duration (20S, 40S, 1M, 2M, 3M, 5M, CC or TRIG).
 - 20S-5M . . . Recording only for the displayed duration
 - CC Recording as long as the alarm signal is being input (minimum recording of 5 seconds)
 - TRIG Will switch between recording pause and recording every time an alarm trigger is received during recording
- 6 Press the **PAUSE/SCAN** button, the normal screen is displayed.
 - o The setting procedure is now completed.

NOTES:

- During alarm recording all buttons are disabled.
- If "OFF" is displayed on the digital display, alarm recording is not possible in order to prevent the recorded tape to be recorded over. To cancel the "OFF" display, press the **EJECT, PLAY, STOP, FF** or **REW** button.
- If an alarm trigger is received while alarm recording is in progress, recording duration for the second alarm will be calculated from that point. The alarm counter will register the alarm, but it will not be found during an alarm scan search.
- If there is a power failure during alarm recording, and the power is restored within the recording set duration, alarm recording will continue.
- If the alarm scan function will be used to review the recordings, set the recording speed to 3-hour mode and the recording duration to 20 seconds or more.

ALARM RECORDING

Alarm Recording Counter Display

- During alarm recording, "AL" will be flashing on the digital display.
- If the **ON SCREEN** switch is set to the "ON" position, the number of alarms will flash on the monitor screen.
- The maximum display number of alarm triggers is "999", at the next alarm recording the counter will indicate "000".
- When the (ALARM TIME) menu is displayed, press the **MENU RESET** button to reset the alarm counter to "000" (all the data of the (ALARM TIME) menu is reset).

GB

Connections to the ALARM IN/OUT Terminals

- Alarm input signal
Connect a make-contact (no voltage) switch between the **ALARM IN** and **COM** terminals.
- Alarm output signal
Normally DC 5V are output between the **ALARM OUT** and the **COM** terminals. When an alarm input (trigger) is received and the unit is recording, the output falls to 0V. Once the alarm recording is over, the output returns to DC 5V.

Checking the Alarm Recordings Time

- 1 Press the **AUDIO ON/MENU** button until the (ALARM TIME) menu is displayed.
 - *The number of alarm triggers, and the 8 most recent alarm recording times are displayed.*

Example

<ALARM TIME>		
008	12-12	19:00
	12-11	23:00
	12-11	15:00
	11-10	08:00
	11-10	06:00
	10-09	20:00
	10-09	16:35
	10-09	10:52

NOTE:

- The data for the previous alarm recordings is erased.
- 2 Press the **PAUSE/SCAN** button, the normal screen is displayed.

NOTE:

- If the **MENU RESET** button is pressed while the (ALARM TIME) menu is displayed, the displayed data is erased.
"AL" will be erased from the digital display.

ALARM RECORDING

Alarm Scan

To look for an alarm recording by viewing the first 5 seconds of each alarm recording.

- ❶ Press the **PAUSE/SCAN** button during stop mode.
 - *“AL SCAN” will be displayed on screen.*
- ❷ Press the **FF** (or **REW**) button.
 - *The unit will advance (or rewind) the tape at high speed and playback the first 5 seconds of every alarm recording.*
 - *To cancel the alarm scan mode, press the **STOP** button.*
- ❸ While the desired recording is being played back, press the **PLAY** button.
 - *Playback will start, alarm scan mode is cancelled.*

PROGRAMME TIMER RECORDING

There are two programme timer recording methods, daily recording or recording on certain days of the week.

Example 1: To record on every Saturday from 9:00 AM to 5:00 PM (17:00), in 24-hour mode (recording speed).

- 1 Make sure that the set date and time are correct.
- 2 Load a cassette tape with erasure-prevention tab.
- 3 Press the **AUDIO ON/MENU** button until the (TIMER SET) menu is displayed.
 - o "SUN" (Sunday) will be flashing.

<TIMER SET>			
WEEK	START	STOP	SPD
SUN	---	---	--- N
MON	---	---	--- N
TUE	---	---	--- N
WED	---	---	--- N
THU	---	---	--- N
FRI	---	---	--- N
SAT	---	---	--- N
DLY	---	---	--- N
EXT	****	****	--- N

- 4 Press the **↓** button, until "SAT" (Saturday) is flashing.
- 5 Press the **→** button.
 - o The recording start hour position starts flashing.
- 6 Press the **▼** (or **▲**) button to set the recording start hour (ex: 09), then press the **→** button.
 - o The recording start minutes position starts flashing.
- 7 Press the **▼** (or **▲**) button to set the recording start minutes (ex: 00), then press the **→** button.
 - o The recording stop hour position starts flashing.
- 8 Press the **▼** (or **▲**) button to set the recording stop hour (ex: 17), then press the **→** button.
 - o The recording stop minutes position starts flashing.

NOTE:

- If the set stop time is earlier than or the same time as the set start time, the VCR will consider the stop time to be the following day, and "T" will be displayed next to the recording stop time.

- 9 Press the **▼** (or **▲**) button to set the recording stop minutes (ex: 00), then press the **→** button.
 - o The "SPD" (recording speed) position will start flashing.
- 10 Press the **▼** (or **▲**) button to select the recording speed (ex: 24), then press the **→** button.
 - o "N" will start flashing.
- 11 Press the **▼** (or **▲**) button to select "Y".
 - Y. recording will take place
 - N. recording will not take place

<TIMER SET>			
WEEK	START	STOP	SPD
SUN	---	---	--- N
MON	---	---	--- N
TUE	---	---	--- N
WED	---	---	--- N
THU	---	---	--- N
FRI	---	---	--- N
SAT	09:00	17:00	24 Y
DLY	---	---	--- N
EXT	****	****	--- N

- 12 Repeat steps 4 to 11 to programme timer recordings for other days of the weeks.
- 12 Press the **PAUSE/SCAN** button, the normal screen is displayed.
- 13 Press the **TIMER** button.
 - o The timer recording indicator "□" will light on the digital display, the VCR is now in timer recording stand-by mode.

NOTES:

- To modify, cancel or stop timer recording, press the **TIMER** button to cancel the timer recording mode.
- A timer recording of more than 24 hours can only be set on the 7th and 8th lines. On the 7th line, set the recording start time and set "*" for the rest of the line. On the 8th line, set "*" for the START time position, then set the recording stop time, recording speed, and select "Y" or "N".
- To record everyday at the same time, at step 4 select the "DLY" line.

GB

PROGRAMME TIMER RECORDING

Setting the Holidays

By setting the holidays, timer recording will be conducted on those days, as set for Sundays.

- 1 Press the **AUDIO ON/MENU** button until the (HOLIDAY SET) menu is displayed.

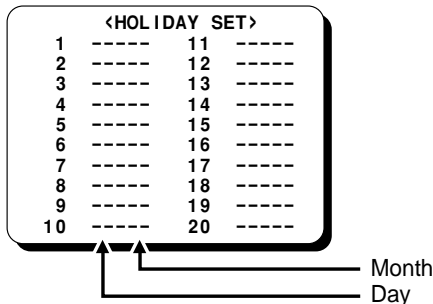

- 2 Press the ▼ (or ▲) button to set the day of the holiday, then press the → button.
- 3 Press the ▼ (or ▲) button to set the month of the holiday.
- 4 Press the → (or ↓) button, the next line to set starts flashing.
 - Repeat steps 2 to 4 to set up to 20 holidays.
- 5 Press the **PAUSE/SCAN** button, the normal screen is displayed.
 - The setting procedure is now completed.

NOTE:

- If setting holidays, be sure that a timer recording is set for Sunday. If not, this function will not operate.

Changing a Programme Timer Recording

- 1 Press the **AUDIO ON/MENU** button until the (TIMER SET) menu is display.
- 2 Press the → (or ↓) button, until the setting to correct is flashing.
- 3 Press the ▼ (or ▲) button, to correct the setting.
- 4 Press the **PAUSE/SCAN** button, the normal screen is displayed.
- 5 Press the **TIMER** button.

To Cancel a Programme Timer Recording

- 1 Press the **AUDIO ON/MENU** button until the (TIMER SET) menu is displayed.
- 2 Press the → (or ↓) button, until the "Y" corresponding to the timer recording to cancel is flashing.
- 3 Press the ▼ (or ▲) button, to select "N".
- 4 Press the **PAUSE/SCAN** button, the normal screen is displayed.
- 5 Press the **TIMER** button.

To Cancel all Programme Timer Recordings

- 1 Press the **AUDIO ON/MENU** button until the (TIMER SET) menu is displayed.
- 2 Press the **MENU RESET** button.
 - All programmed timer recordings are erased.
- 3 Press the **PAUSE/SCAN** button, the normal screen is displayed.

PROGRAMME TIMER RECORDING

NOTES:

- During timer recording or timer recording stand-by, all the buttons on the VCR, except the **TIMER** button, are disabled.
- If the power fails, the recording will be interrupted. When the power is restored, the recording will resume if the stop time has not yet been reached, and "P" will be displayed on the digital display. The VCR internal battery is completely recharged after the VCR has been connected to a live outlet for 48 hours, and it will maintain all the VCR settings memory for up to 30 days.
- Set the timer recordings so that the recording times do not overlap. If they do, the one with the earliest recording start time will have priority. (See chart below.)

GB

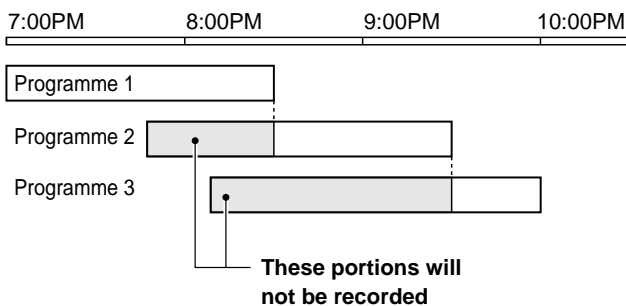

- To set two or more timer recordings for a same day of the week, press the → (or ↓) button, until the day of the week for the second recording is flashing, then press the ▼ (or ▲) button, to set the desired day of the week.
- If no timer recording is set or a cassette without erasure-prevention tab is loaded, when the **TIMER** button is pressed the timer recording indicator "□" will start flashing and a buzzer will be heard.
- If "OFF" is displayed on the digital display, timer recording is not possible in order to prevent the recorded tape to be recorded over.

RECORDING USING AN EXTERNAL TIMER INPUT

Recording can be controlled by an external start/stop signal input at the **EXT TIMER IN** terminal.

Example 2: To record using the signal input at the **EXT TIMER IN** terminal, in 12-hour mode.

NOTE:

- External timer input recording can only be set on the 9th line ("EXT") of the (TIMER SET) menu.
- Follow steps 1 to 3 under "PROGRAMME TIMER RECORDING" on page 17.

<TIMER SET>			
WEEK	START	STOP	SPD
SUN	---:--	---:--	--- N
MON	---:--	---:--	--- N
TUE	---:--	---:--	--- N
WED	---:--	---:--	--- N
THU	---:--	---:--	--- N
FRI	---:--	---:--	--- N
SAT	---:--	---:--	--- N
DLY	---:--	---:--	--- N
EXT	*****	*****	--- N

← 9th line

- Press the ↓ button, until "EXT" (External) setting is flashing.
 - The "SPD" (recording speed) position will start flashing.
- Press the ▼ (or ▲) button to select the recording speed (ex: 12), then press the → button.
 - "N" will start flashing.
- Press the ▼ (or ▲) button to select "Y".

<TIMER SET>			
WEEK	START	STOP	SPD
SUN	---:--	---:--	--- N
MON	---:--	---:--	--- N
TUE	---:--	---:--	--- N
WED	---:--	---:--	--- N
THU	---:--	---:--	--- N
FRI	---:--	---:--	--- N
SAT	---:--	---:--	--- N
DLY	---:--	---:--	--- N
EXT	*****	*****	12 Y

- Follow steps 12 and 13 under "PROGRAMME TIMER RECORDING" on page 17.
 - When an external signal is input, "E" will light on the digital display and recording will take place.

NOTES:

- Other timer recordings using the standard procedure can also be programmed.
- When there is a signal being input at the **EXT TIMER IN** terminal, "E" will be displayed on the digital display and recording is conducted.

NORMAL PLAYBACK

Normal Playback

- ❶ Turn on the power to the VCR and TV monitor.
- ❷ Load the video cassette tape.
- ❸ Press the **REC/PLAY SPEED** button to select the playback speed.
 - *The selected playback speed is displayed on the digital display.*

NOTE:

- A slow motion effect or accelerated playback effect can be achieved by using a slower or faster playback speed than the speed used for recording.

- ❹ Press the **PLAY** button.
 - *Playback starts.*
 - *If necessary, adjust the tracking to eliminate the noise from the picture.*
- ❺ To stop playback, press the **STOP** button.
 - *To advance or rewind the tape, press the **FF** or **REW** button.*

NOTES:

- A tape recorded on a time lapse VCR produced by another manufacturer can not be played back on this unit.
- A tape recorded on this VCR cannot be played back on a time lapse VCR produced by another manufacturer.

Tracking Control

If there is noise in the image during playback,

- ❶ While looking at the playback picture, press and hold the **TRACKING/V. STILL+** button to minimize the noise.
- ❷ If it cannot be minimized, press the **TRACKING/V. STILL-** button.

Vertical Lock Control

During still image mode,

- ❶ Press and hold the **TRACKING/V. STILL+** button to reduce the vertical rolling of the image.
- ❷ If it cannot be corrected, press the **TRACKING/V. STILL-** button.

Audio Playback

- The playback speed has to be the same as the recording speed, for normal playback of the audio.
- For a tape recorded in 12-hour and 24-hour recording modes, to playback the audio, press the **AUDIO ON/MENU** button after pressing the **PLAY** button. "A" will be displayed to the left of the playback speed on the digital display.

NOTE:

- Noise will appear in the image when audio playback is used in 12- or 24-hour modes.

SPECIAL PLAYBACK

Picture Search

- 1 Press the **FF** (or **REW**) button, during normal playback.
 - *The image can be seen while the tape is advanced (or rewound) at high speed.*
- 2 To return to normal playback, press the **PLAY** button.

NOTES:

- During picture search, noise (horizontal bars) will appear in the picture.
- The sound is muted.

Still Image

- 1 Press the **PAUSE/SCAN** button, during normal playback.
 - *A still image can be viewed.*
- 2 To return to normal playback, press the **PLAY** button.

NOTES:

- If still mode continues for 5 minutes or more, the VCR will go into stop mode to avoid damaging the tape.
- If the image is unstable (rolling vertically), adjust the vertical lock control to correct.

Frame Advance

- 1 Press the **FF** button, during still image mode.
 - *The still image is advanced of one image (field).*
- 2 To return to normal playback, press the **PLAY** button.

SETTING THE SECURITY LOCK

The security lock function is designed to prevent accidental stopping of recording if the **STOP** button is pressed inadvertently.

- 1 While holding the **TRACKING/V.STILL +** button, press the **REC/PLAY SPEED** button.
 - "1" is displayed on the digital display.

To cancel the security lock, while holding the **TRACKING/V.STILL +** button, press the **REC/PLAY SPEED** button, "1" will be erased from the digital display.

NOTES:

- While the security lock is engaged all commands, except the one to cancel the security lock, are disabled.
- The security lock cannot be engaged while a menu is displayed.

GB

SETTING THE BUZZER

If desired a buzzer can warn you when an alarm recording is taking place, when the tape has reached the end or when buttons are being pressed on the VCR.

- 1 Press the **AUDIO ON/MENU** button until the (SET UP 2) menu.

<SET UP 2>	
*DISPLAY	
DATE	Y
TIME	Y
ALARM COUNT	Y
SPEED	Y
*BUZZER	
ALARM IN	Y
TAPE END	Y
KEY IN	N

- 2 Press the **↓** button, until the desired item for which the buzzer function will be set is flashing.
- 3 Press the **▼** (or **▲**) button to set "Y" for the functions described below.

ALARM IN The buzzer will be heard during alarm recording.

TAPE END The buzzer will be heard when the end of the tape is reached during recording.

KEY IN The buzzer will be heard when one of the VCR buttons is pressed.

- 4 Press the **PAUSE/SCAN** button, the normal screen is displayed.
 - The setting procedure is now completed.

NOTES:

- If "N" is set, the buzzer will not be heard.
- During timer recording mode, security lock engaged mode and alarm recording mode, the buzzer will not be heard when a button related to one of these modes is pressed, even if "Y" is set for the "KEY IN" item.

CHECKING USAGE DURATION

- 1 Press the **AUDIO ON/MENU** button until the (USED TIME) menu is displayed.

(USED TIME) The video heads usage duration and the power on duration are displayed.

- 2 Press the **PAUSE/SCAN** button, the normal screen is displayed.

NOTE:

- The (USED TIME) data cannot be reset.

Example

<SET UP 4>	
*SW OUT	
FIELD	01
TIMING	FIELD
3H	Y
<USED TIME>	
VIDEO	00003H
POWER	00007H

CHECKING POWER FAILURE AND FAILURE DUE TO CONDENSATION

GB

- 1 Press the **AUDIO ON/MENU** button until the (POWER FAILURE) and (DEW) menu is displayed.

(POWER FAILURE) The number of power failures, and the date and time of the most recent power failure and recovery are displayed.

(DEW). The number of failures due to condensation, and the date and time of the most recent failure and recovery are displayed.

- 2 Press the **PAUSE/SCAN** button, the normal screen is displayed.

NOTE:

- If the **MENU RESET** button is pressed while the (POWER FAILURE) and (DEW) menu is displayed, the data is erased.
"P" will be erased from the digital display.

Example

<POWER FAILURE>		
002	FAILURE	11-10 07:15
	RECOVERY	11-10 07:30
<DEW>		
001	FAILURE	10-10 11:00
	RECOVERY	10-10 12:00

OUTPUT TERMINALS

TAPE END OUT Terminal

- During recording, when the end of the tape is reached or when the tape counter reading indicates 2 hours 57 minutes or more, the output becomes 0V (Low).
- During autorepeat recording, when the end of the tape is reached, the output become 0V (Low) for about 2 seconds only.
- To reset the output, press the **STOP** or **EJECT** button.

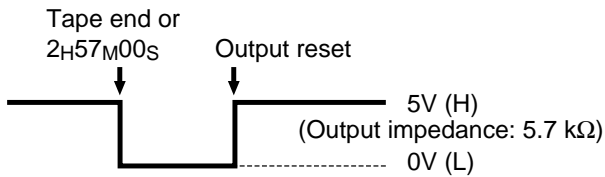

TAPE END OUT Terminal Output Setting

- 1 Press the **AUDIO ON/MENU** button until the (SET UP 3) menu is displayed.

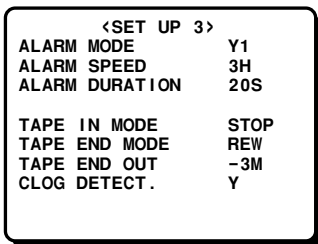

- 2 Press the ↓ button, until the “TAPE END OUT” setting is flashing.
- 3 Press the ▼ (or ▲) button, to select the desired output mode.
 - 3M. The output become 0 V (Low) when the tape counter reaches “2:57:00” and/or when the tape reaches the end.
 - END The output become 0 V (Low) when the tape reaches the end.
- 4 Press the **PAUSE/SCAN** button, the normal screen is displayed.

WARNING OUT Terminal

- If the tape stops or other problem, the output becomes 0V (Low).
- To reset the output, unplug the power cord then plug it back in or press the **ALL RESET** button.

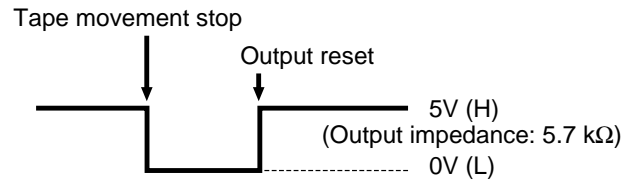

NOTE:

- If the output is 0V (Low) due to the clog detect function, it can be reset by simply pressing the **STOP** button.

COM Terminal

- Common GND (ground) terminal when connecting other terminals to external devices.

GB

OUTPUT TERMINALS

SW OUT Terminal

When recording, a pulse signal is output at the **SW OUT** terminal.

This terminal is usually connected to the switch input (SW IN) of devices like a camera switcher unit, or a quad compressor.

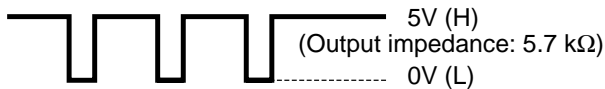

SW OUT Terminal Output Setting

- Press the **AUDIO ON/MENU** button until the (SET UP 4) menu is displayed.
 - The **FIELD** (or **FRAME**) setting is flashing.

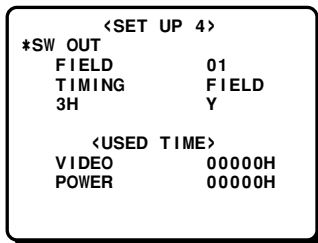

NOTE:

- If "TIMING" is set to FRAME (see step 4), "FRAME" will be indicated instead of "FIELD".
- Press the **▼** (or **▲**) button, to set the pulse signal interval.

Available settings are:

FIELD 01, 02, 03, 04, 05, 10, 30 or 60 field

FRAME 01, 02, 03, 04, 05, 10, 30 or 60 frame
 - Press the **↓** button to select the output timing.
 - Press the **▼** (or **▲**) button, to set "FIELD" or "FRAME".

FIELD 1 pulse is output after each set number of fields.

FRAME 1 pulse is output after each set number of frames.
 - Press the **↓** button.
 - The "3H" setting starts flashing.
 - Press the **▼** (or **▲**) button, to set the "3H".

Y When recording in 3-hour mode, a pulse signal is output.

N When recording in 3-hour mode, a pulse signal is not output.
 - Press the **PAUSE/SCAN** button, the normal screen is displayed.

REMOTE Jack

- You can use a VA-RMN01 Remote Control Unit (sold separately) to control remotely the VCR.
- Remote control of the VCR is possible by connecting a remote controller with a circuit such as indicated below, to the **REMOTE** jack.

NOTES:

- Use a 3.5 mm mini-jack type plug.
- The connection should be done using a shielded cable no more that 5 meters long.

Remote control circuit

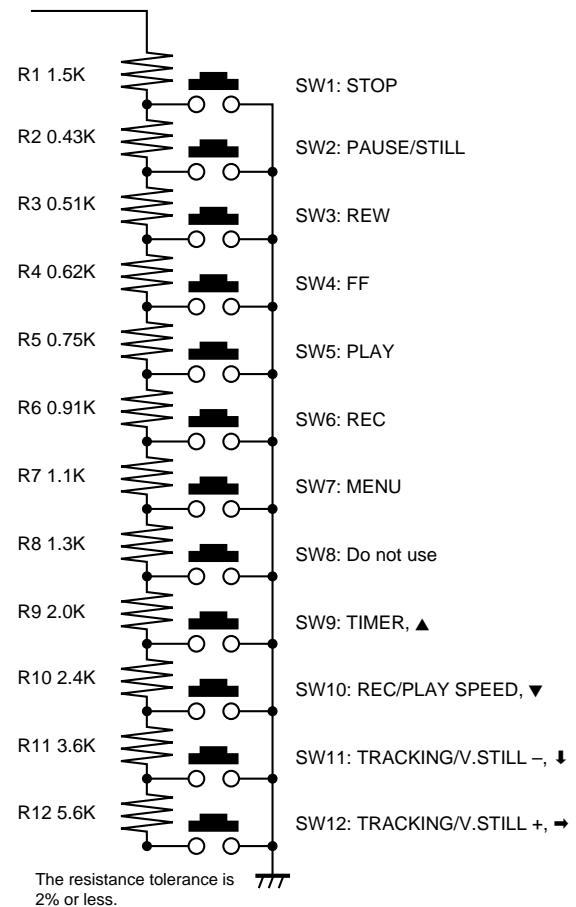

NOTES:

- The functions not available on the VCR will not operate.
- The **REC/PLAY SPEED ▲** button on the VA-RMN01 will function as the **TIMER** button on the VCR.

GB

MAINTENANCE

Daily Inspection

The following daily inspections are recommended in order to assure long-term and trouble-free operation of the unit.

The daily inspections are particularly important if using autorepeat recording.

Inspection Procedure

- ❶ Turn on the power to the VCR, camera, TV monitor and other connected devices.
- ❷ Check that the image received on the TV monitor is correct.
- ❸ Check that the on-screen display of the date and time is correct.
- ❹ To check the recording condition of the previous day, rewind the recorded tape a few seconds.
- ❺ Press the **PLAY** button and check that the playback image is correct.
 - Check in particular playback of time lapse recording.
- ❻ Check that the recorded date and time are correct.

NOTES:

- If the security lock is engaged, it has to be released before proceeding to the inspection.
- If any problem is discovered during the inspection, turn off the VCR, unplug the power cord then consult your dealer.

Periodic Inspection

Periodic inspection and maintenance should be referred to your dealer.

If there is noise in the playback picture, and it cannot be corrected using the tracking control, it may indicate that the video heads need cleaning.

The video heads should be inspected every 1,000 hours of use to determine if they need to be replaced.

The video heads usage can be checked using the (USED TIME) menu.

Head Care and Cleaning

The VCR has a built-in automatic head cleaner. Under normal conditions, the heads should not require additional cleaning.

Cabinet Cleaning

Clean the outside of the cabinet with a clean, soft cloth, moistened with lukewarm water and wrung dry.

DO NOT USE SOLVENTS OR OTHER TYPES OF CLEANERS. THESE CHEMICALS CAN CRACK OR DISCOLOR THE CABINET.

TROUBLESHOOTING GUIDE

If the unit does not operate normally when you follow the instructions indicated in the manual, please refer to the table below.

SYMPTOM	POSSIBLE CAUSE	CORRECTIVE ACTION
No power	The power cord is not connected	Connect the power cord
No image displayed on the monitor TV	The connections are not correct	Check that all connections are correct
	The power to the camera and/or monitor TV is not turned on	Turn all connected devices power on
The buttons do not respond	A cassette tape is not loaded	Load a cassette and turn the power on
	All functions are suspended due to condensation	Wait for the "dd dd" indicator to go off
	Alarm recording	Wait for the alarm recording to end
	The security lock is engaged	Cancel the security lock
Recording is not possible (the tape is ejected)	The loaded cassette has no erasure-prevention tab	Load a cassette tape with erasure-prevention tab or cover the tab hole with adhesive tape
Autorepeat recording is not possible	"AL" is displayed on the digital display	Display (ALARM TIME) menu, then press the MENU RESET button to turn off the "AL" indicator
Timer recording is not possible	The date and time are not set correctly	Set the date and time correctly
	The unit is not set to timer recording stand-by mode	Press the TIMER button to display "□" on the digital display
	"N" is selected for the timer recordings	Be sure to select "Y" for the programmed timer recordings
Alarm recording is not possible	"OFF" is displayed on the digital display	Press the EJECT, STOP, FF, REW or PLAY button to turn the indicator off
Noise in the playback picture	The video heads need cleaning	Clean the video heads
The date and time are not recorded	The ON SCREEN switch is set to the "OFF" position	Set the ON SCREEN switch to the "ON" position
The cassette tape cannot be ejected	Problem with the system	Turn the power off, then on again

GB

After a Power Failure

If after a power failure the recording speed is reset to 3-hour mode, it is due to insufficient backup battery charge. This is not a malfunction.

System Down

If the unit does not function at all, try the following.

- ❶ Unplug the power cord then plug it back in.
- ❷ Reset the memory. (Press the **ALL RESET** button. Under normal conditions, do not touch the **ALL RESET** button.)
- ❸ If the problem is not corrected after performing steps ❶ and ❷ a few times, consult your dealer.

SPECIFICATIONS

General Specifications

Recording method	Dual-azimuth 2-head rotating helical scanning system
Audio recording	In 3-, 12-, and 24-hour modes
Tape speed	23.39 mm /sec (3-hour mode)
Specified video cassette tape	VHS 1/2 inch
Recording/playback time	3, 12, and 24 hours (when using E-180 tape)
Fast forward/rewind time	approximately 2 minutes 45 seconds (when using E-180 tape)
Standard	CCIR PAL colour

Video

Recording method	Luminance signal: FM recording Chrominance signal: Down-converted direct recording
Video input	1 Vp-p, BNC, 75 Ω , unbalanced
Video output	1 Vp-p, BNC, 75 Ω , unbalanced
Horizontal resolution	Black & white mode 350 line or more Colour mode 250 line or more

GB

Audio

Input	-8 dBs, RCA pin jack, 27 k Ω , unbalanced
Output	-8 dBs, RCA pin jack, 600 Ω , unbalanced
Microphone input	-60 dBs, 3.5 mm mini jack, 10 k Ω , unbalanced

Connectors

Alarm input	Low level active (0V)
Alarm output	DC 5 V (± 0.5)/5.7 k Ω , Low at alarm
Tape end output	DC 5 V (± 0.5)/5.7 k Ω , Low at tape end
Warning output	DC 5 V (± 0.5)/5.7 k Ω , Low at warning
Switch output	DC 5 V (± 0.5)/5.7 k Ω , Low at switching
Ext timer input	Low level active (0V)
DC 12 V "+" input	DC 12 V
DC 12 V "-" input	DC 0 V
Common	0 V (GND)
Remote control input	3.5 mm mini jack
DC 12 V input	Mini jack

Other Specifications

Operating temperature range	5°C to 40°C
Operating humidity range	80% or less
Power requirements	DC 12 V (10 V to 16 V)
Power consumption	14 W
Dimensions	240 (W) x 96.5 (H) x 335 (D) mm
Weight	approximately 3.8 kg

NOTE: The specifications and external appearance of this unit are subject to change without notice.

SANYO

SANYO Electric Co., Ltd.