

Model:
VRTIKL-AU
FREESTANDING STOVE

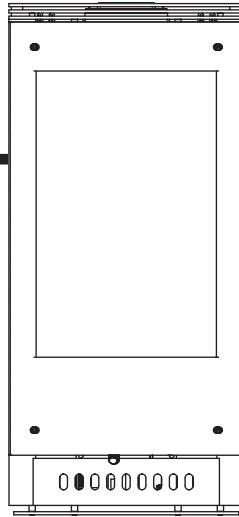

Installation & Operation Instructions

AUSTRALIAN GAS ASSOCIATION CERTIFIED

Certificate Number: 7153



CAUTION

DO NOT DISCARD THIS MANUAL

- Important operating and maintenance instructions included.
- Read, understand and follow these instructions for safe installation and operation.
- Leave this manual with party responsible for use and operation.



⚠ WARNING: If the information in these instructions is not followed exactly, a fire or explosion may result causing property damage, personal injury, or death.

- Do not store or use gasoline or other flammable vapors and liquids in the vicinity of this or any other appliance.
- **What to do if you smell gas**
 - Do not try to light any appliance.
 - Do not touch any electrical switch. Do not use any phone in your building.
 - Immediately call your gas supplier from a neighbor's phone. Follow the gas supplier's instructions.
 - If you cannot reach your gas supplier, call the fire department.
- Installation and service must be performed by a qualified installer, service agency, or the gas supplier.



⚠ WARNING

HOT! DO NOT TOUCH.
SEVERE BURNS MAY RESULT.
CLOTHING IGNITION MAY RESULT.

Glass and other surfaces are hot during operation and cool down.

- Keep children away.
- CAREFULLY SUPERVISE children in same room as appliance.
- Alert children and adults to hazards of high temperatures.
- Do NOT operate with protective barriers open or removed.
- Keep clothing, furniture, draperies and other combustibles away.

Installation and service of this gas stove should be performed by qualified personnel.

Table of Contents

1 Listing and Code Approvals

- A. Design and Installation Considerations 4
- B. Non-Combustible Materials Specification 4
- C. Combustible Materials Specification 4
- D. Inspect Appliance and Components 4

2 Framing and Clearances

- A. Selecting Appliance Location 5
- B. Clearances to Combustibles 5
- C. Optional Stone Surround Installed 6

3 Termination Locations

- A. Flue Termination Minimum Clearances 7

4 Flue Information

- A. Flue Components 9
- B. Use of Elbows 9
- C. Measuring Standards 9
- D. Flue Diagrams 10
- E. Horizontal Termination 15
- F. Slim Line Heat Shield 16
- G. Vertical Termination 18
- H. Vertical Flue Restrictor 20

5 Gas Information

- A. Gas Pressure Requirements 21
- B. Gas Connection 21

6 Electrical Information

- A. Ignition System Wiring 22

7 Appliance Setup

- A. Remove Glass Door 23
- B. Remove Shipping Materials 23
- C. Unbolting Appliance from the Pallet 23
- D. Leveling and Lagging Down the Appliance 23
- E. Accessories 24
- F. Top to Rear Flue Conversion 24
- G. Positioning the Logs 26
- H. Placing Mineral Wool 26

8 Operating Instructions

- A. Before Lighting Appliance 27
- B. Lighting the Appliance 28
- C. After Appliance is Lit 29
- D. Frequently Asked Questions 29

9 Maintaining and Servicing Appliance

- A. Front Door Glass Assembly Removal 30
- B. Maintenance Tasks 31

10 Troubleshooting

- A. Electronic Ignition System 32

11 Reference Materials

- A. Appliance Dimension Diagram Without Stone Surround 33
- B. Appliance Dimension with Stone Surround Diagram 34
- C. Flue Components List 35
- D. Service Parts 36
- E. Warranty Policy 39
- F. Contact Information 40

5 Gas Information

A. Gas Pressure Requirements

Pressure requirements for VRTIKL-AU Stoves are shown in Table 1 below.

Two taps are provided on the right hand side of the gas control for a test gauge connection to measure the inlet and outlet pressures. See **Section 10: Maintaining and Servicing the Appliance.**

The stove and its individual shut-off valve must be disconnected from the gas supply piping system during any pressure testing of the system at test pressures in excess of 60 mbar.

If the stove must be isolated from the gas supply piping system by closing an individual shut-off valve, it must be of the handle-less type.



 WARNING	
	<p>Fire Risk. Explosion Hazard. High pressure will damage valve.</p> <ul style="list-style-type: none"> • Disconnect gas supply piping BEFORE pressure testing gas line at test pressures above 6 kPa. • Close the manual shutoff valve BEFORE pressure testing gas line at test pressures equal to or less than 6kPa..
	

Table 1



	Natural Gas	Propane
Minimum Inlet Pressure	1.13 kPa	2.75 kPa
Outlet Pressure	.80 kPa	2.40 kPa
Max. Gas Consumption	26.7 mJ	24.5 mJ
Burner Injector	2.53 mm	1.45 mm

B. Gas Connection

Note: Have the gas supply line installed in accordance with local building codes by a qualified installer approved and/or licensed as required by the locality.

Note: Before the first firing of the stove, the gas supply line should be purged of any trapped air.

Leak test all gas line points and the gas control valve prior to and after starting the gas stove.

 WARNING	
	<p>CHECK FOR GAS LEAKS Explosion Risk Fire Risk Asphyxiation Risk</p> <ul style="list-style-type: none"> • Check all fittings and connections. • Do not use open flame. • After the gas line installation is complete, all connections must be tightened and checked for leaks with a commercially-available, non-corrosive leak check solution. Be sure to rinse off all leak check solution following testing.
	<p>Fittings and connections may have loosened during shipping and handling.</p>

6 Electrical Information

A. Ignition System Wiring

- This gas stove is equipped with an electronic ignition system which operates on a 6 volt system.
- The batteries are located within the ignition module which is located behind the glass door assembly. A wiring diagram is shown in Figure 7.1.
- The ignition module requires four AA batteries (not included).



⚠ WARNING

Shock hazard.

- Replace damaged wire with type 105° C rated wire.
- Wire must have high temperature insulation.

CAUTION

Label all wires prior to disconnection when servicing controls. Wiring errors can cause improper and dangerous operation. Verify proper operation after servicing.

CAUTION

Battery polarity must be correct or module damage will occur.

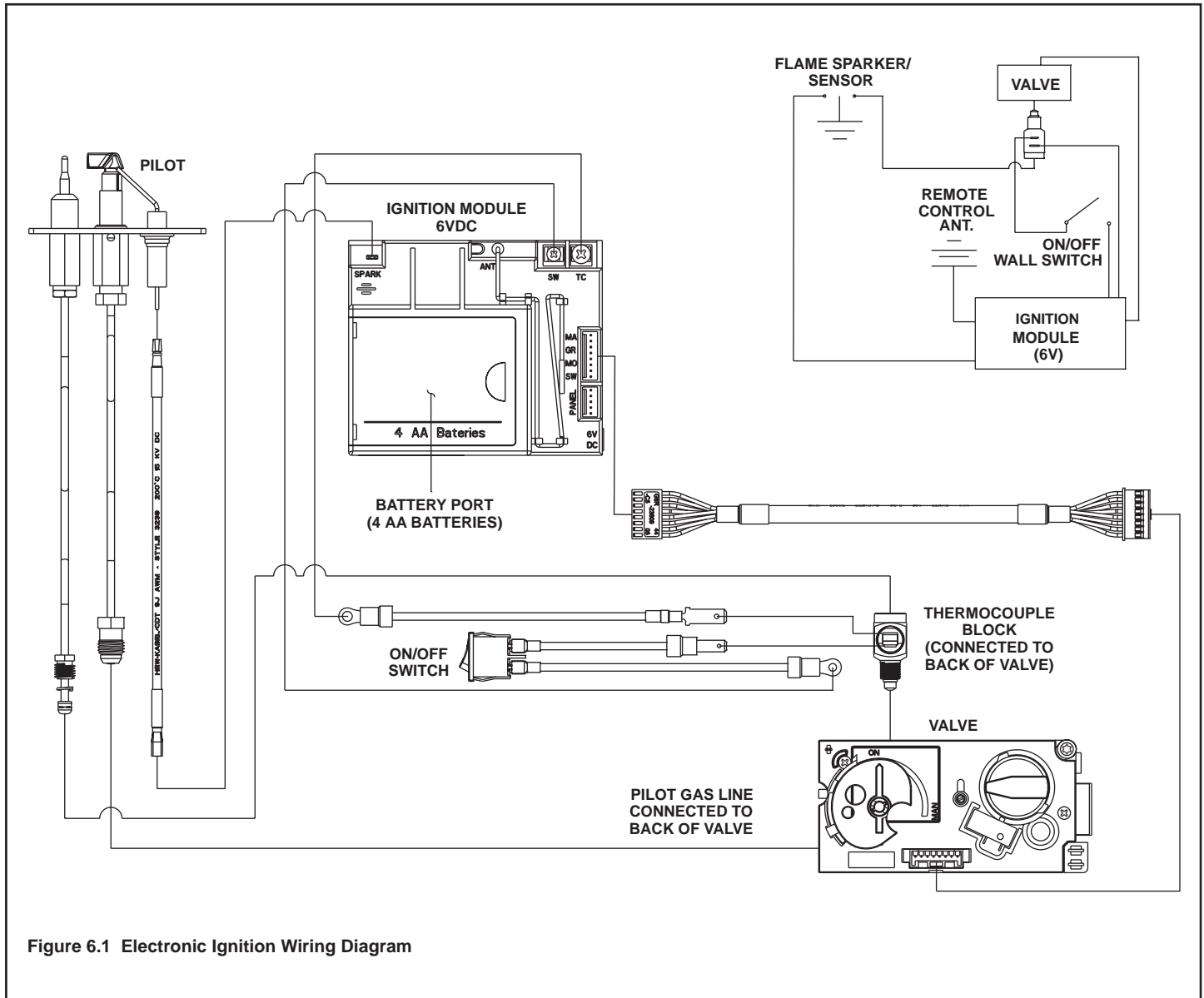

Figure 6.1 Electronic Ignition Wiring Diagram

7 Appliance Setup

A. Remove Glass Door

Remove the front door assembly by pulling bottom of front away from gas stove and lifting it off of the hooks on top of the stove. Set door assembly aside.

B. Remove Shipping Materials

Remove shipping materials from inside or underneath the firebox.

The gas line is shipped inside back panel. To access the gas line remove the top plate from the gas stove. Remove and retain the two Allen head screws that hold the back panel in place. Replace panel when finished.

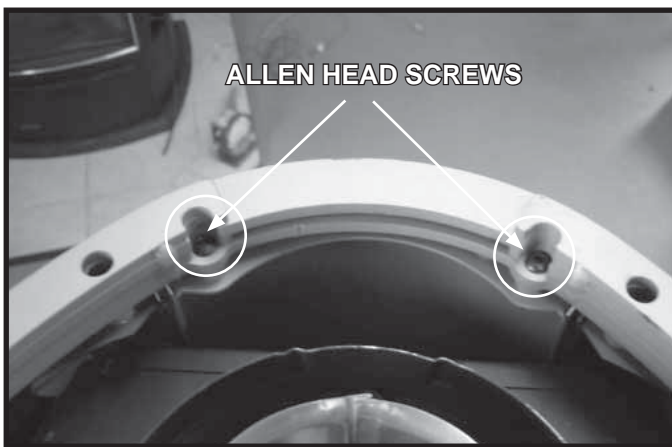

Figure 7.1

C. Unbolting Appliance from the Pallet

The gas stove is bolted and screwed to the pallet for shipping. Use a 1/2 in. socket to remove the bolt in center of bottom plate. Use a Phillips screwdriver to remove the two screws in the front of the bottom plate and the two screws holding the metal strap across the back of the gas stove. Refer to **Figure 7.2** for locations.

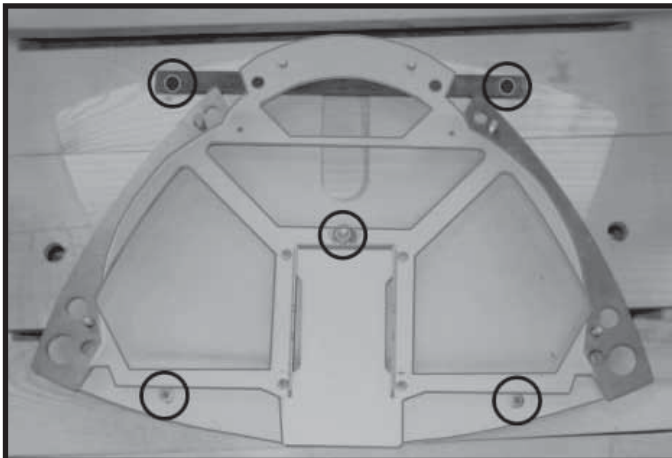



Figure 7.2

D. Leveling and Lagging Down the Appliance

SECURING THE GAS STOVE IS REQUIRED.

⚠ WARNING	
	Fire Risk.
	Odor Risk.
	Tipping Risk
	<ul style="list-style-type: none">• Install gas stove on a stable, level platform/floor strong enough to support gas stove without tipping.• <u>USE</u> wood flooring, ceramic tile, brick hearth or high pressure laminate flooring applied directly over the sub-flooring material.

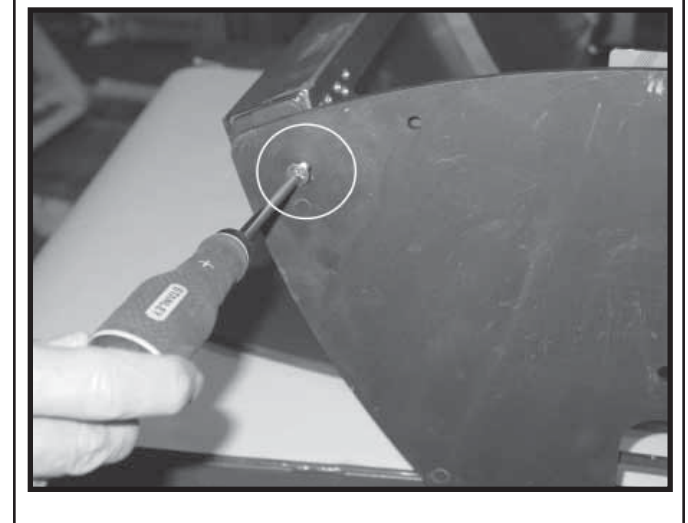
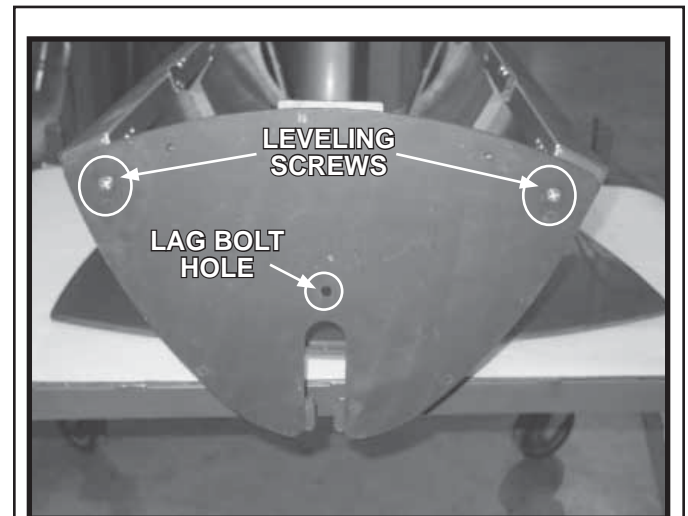

Figure 7.3

After unbolting the gas stove from the pallet, insert two 1/4 20 x 1-1/2 (or equivalent) counterscrews.

Using pliers, adjust the counterscrews to level the gas stove.

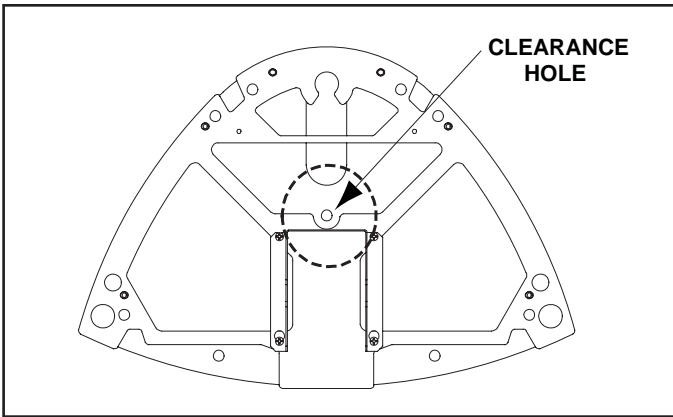

Figure 7.4

The manufacturer recommends securing the lag bolt from the component bag in the center hole in the bottom plate (clearance hole). This bolt will help to prevent tipping forward.

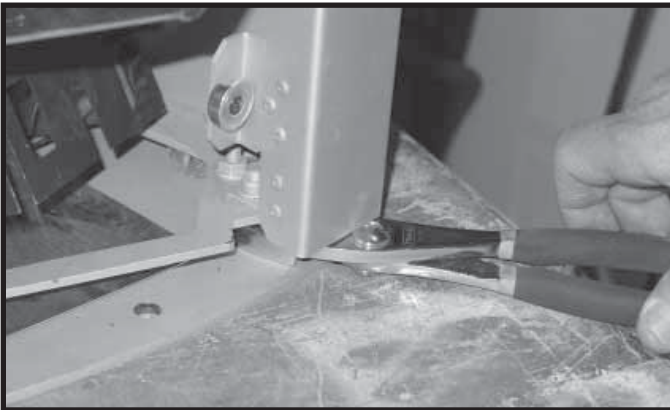

Figure 7.5

Using pliers, adjust the counter screws to level the gas stove.

E. Accessories

Install approved accessories per instructions included with accessories.

	<p>⚠ WARNING</p> <p>Shock or fire risk.</p> <p>Use ONLY optional accessories approved for this appliance.</p>
	<ul style="list-style-type: none"> • Using non-listed accessories voids warranty. • Using non-listed accessories may result in a safety hazard. • Only Hearth & Home Technologies approved accessories may be used safely.

F. Top to Rear Flue Conversion

KIT CONTENTS: Top cover (without hole);
Back panel (with hole).

1. Remove the front door assembly by pulling bottom of front away from gas stove and lifting it off of the hooks on top of the gas stove. Set door aside.

ON TOP OF APPLIANCE:

2. Remove the top plate with hole and discard. (Figure 7.7)



Figure 7.7

3. Remove and retain the Allen head screws that hold the solid back panel in place (Figure 7.8). Remove and discard the solid back panel.

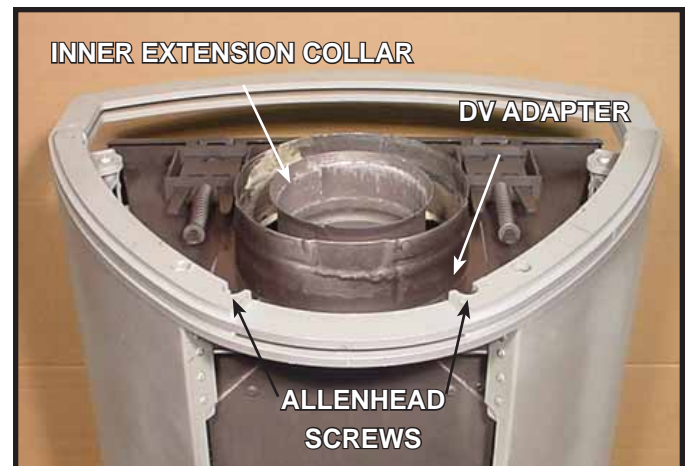

Figure 7.8

4. Remove the inner extension collar (Shown in Figure 7.8) and set aside.
5. Remove the four screws from the DV adapter collar (Figure 7.8). Set aside DV adapter collar and screws.

ON BACK OF APPLIANCE:

6. Remove the four screws from the cover plate on rear of gas stove. Set cover plate aside. Retain screws. (See **Figure 7.9**). Attach DV adapter collar in its place. Install the inner extension collar.

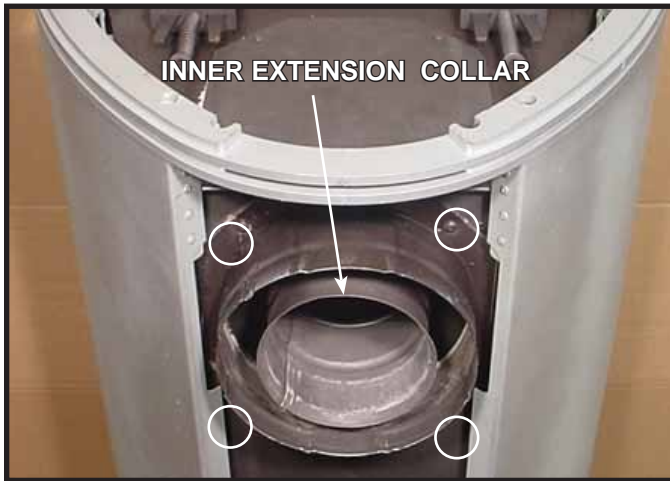

Figure 7.9

7. Install the cover plate with gasket to the top of gas stove with screws previously removed (**Figure 7.10**).



Figure 7.10

ON TOP OF APPLIANCE:

8. Install the new back panel (without hole) to the rear of gas stove. Replace the Allen head screws removed in Step 3 to hold the back panel in place.
9. Install the new top as shown in Figure 7.11.



Figure 7.11

G. Positioning the Logs

While still breakable, the logs do not become fragile until after the gas stove is burned and they have cured. After curing, any handling must be done with care as breakage can easily occur.

PLEASE NOTE: Logs have been designed to work specifically with the burner of this gas stove. Exact placement will ensure proper operation of your gas stove.

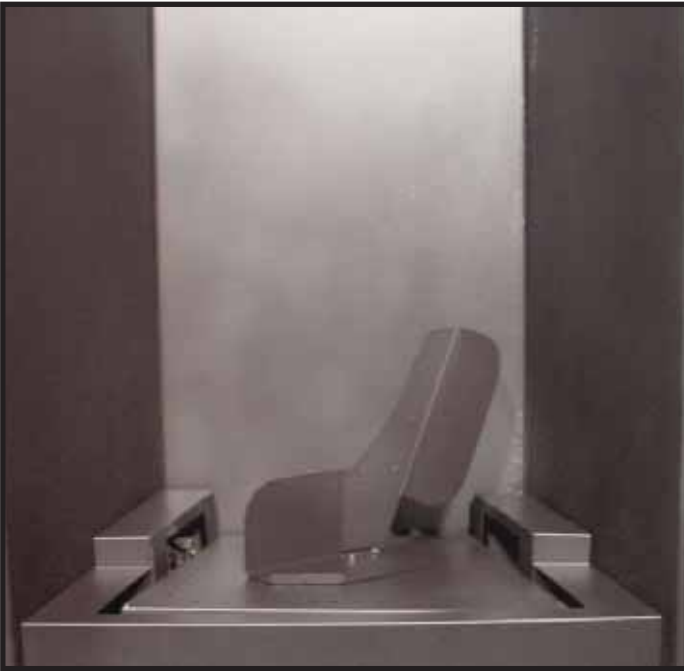

Figure 7.13



Figure 7.14

Place log #1 into the cradle in the burner. Lean the log back towards right corner of firebox.



Figure 7.15

Locate log #2 over the pin in log #1 and into notch in log #1. Lean the log back toward the left corner of the fire-box.

H. Placing Mineral Wool

⚠ WARNING



Explosion Risk.

- Follow ember placement instructions in manual.
- Do NOT place embers directly over burner ports.
- Replace ember material annually.

Improperly placed embers interferes with proper burner operation.

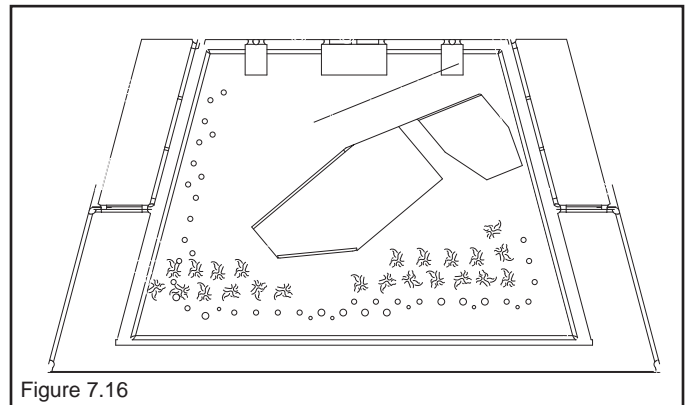

Figure 7.16



Apply 15 mm size pieces sparingly along ports as shown. Do not block ports.



8 Operating Instructions



A. Before Lighting Appliance

Read this entire manual prior to using the appliance. Failure to follow the instructions may result in property damage, bodily injury, or even death.

- Remove all shipping materials from inside and/or underneath the firebox.
- Review proper placement of logs and mineral wool.
- Check the wiring.
- Check the baffle adjustment.
- Ensure that there are no gas leaks.
- Ensure that the glass is sealed and in the proper position.
- Ensure that the flow of combustion and ventilation air is not obstructed (front grilles and flue terminations).



	⚠ WARNING
	Glass door must be in place when appliance is operating. Risk of: <ul style="list-style-type: none">• Combustion Fumes• Fire Do NOT operate appliance with glass door removed. <ul style="list-style-type: none">• Open viewing glass for servicing only.
	<ul style="list-style-type: none">• Glass door MUST be in place and sealed before operating appliance.• Only use glass door certified for use with appliance.• Glass replacement should be done by qualified technician.

	⚠ WARNING
	Risk of Fire Risk of Burns <ul style="list-style-type: none">• Do not remove guard. The guard is fitted to this appliance to reduce the risk of fire or injury from burns and no part of it should be permanently removed. For protection of young children or the infirm, a secondary guard is required.

	⚠ WARNING	
	HOT! DO NOT TOUCH. SEVERE BURNS MAY RESULT. CLOTHING IGNITION MAY RESULT.	
	Glass and other surfaces are hot during operation and cool down. <ul style="list-style-type: none">• Keep children away.• CAREFULLY SUPERVISE children in same room as appliance.• Alert children and adults to hazards of high temperatures.• Do NOT operate with protective barriers open or removed.• Keep clothing, furniture, draperies and other combustibles away.	

⚠ WARNING
Improper installation, adjustment, alteration, service or maintenance can cause injury or property damage. Refer to the owner's information manual provided with this appliance. For assistance or additional information consult a qualified installer, service agency or the gas supplier.

⚠ WARNING
Do NOT use this appliance if any part has been under water. Immediately call a qualified service technician to inspect the appliance and to replace any part of the control system and any gas control which has been under water.

	⚠ WARNING
	Risk of Fire Risk of Burns <ul style="list-style-type: none">• Do not place articles on or against this appliance.• Do not use or store flammable materials near this appliance.• Do not spray aerosols in the vicinity of this appliance while it is in operation.

B. Lighting the Appliance

Electronic Ignition

FOR YOUR SAFETY READ BEFORE LIGHTING

WARNING: If you do not follow these instructions exactly, a fire or explosion may result causing property damage, personal injury or loss of life.

- A.** This heater is equipped with an electronic pilot ignition device which automatically lights the burner. Do not try to light the burner by hand.
- B. BEFORE LIGHTING**, smell all around the heater area for gas. Be sure to smell next to the floor because some gas is heavier than air and will settle on the floor.
- WHAT TO DO IF YOU SMELL GAS**
- Do not try to light any appliance.
 - Do not touch any electric switch; do not use any phone in your building.
 - Immediately call your gas supplier from a neighbor's phone. Follow the gas supplier's instructions.
 - If you cannot reach your gas supplier, call the fire department.
- C.** Do not use this fireplace if any part has been under water. Immediately call a qualified service technician to inspect the heater and to replace any part of the control system and any gas control which has been under water.

WARNING:

Improper installation, adjustment, alteration, service or maintenance can cause injury or property damage. Refer to the owner's information manual provided with this fireplace.

This heater needs fresh air for safe operation and must be installed so there are provisions for adequate combustion and ventilation air.

If not installed, operated, and maintained in accordance with the manufacturer's instructions, this product could expose you to substances in fuel or fuel combustion.

Keep burner and control compartment clean. See installation and operating instructions accompanying heater.

CAUTION:

Hot while in operation. Do not touch. Keep children, clothing, furniture, gasoline and other liquids having flammable vapors away.

Do not operate the heater with panel(s) removed, cracked or broken. Replacement of the panel(s) should be done by a licensed or qualified service person.



NOT FOR USE WITH SOLID FUEL

For use with natural or propane gases.

LIGHTING INSTRUCTIONS

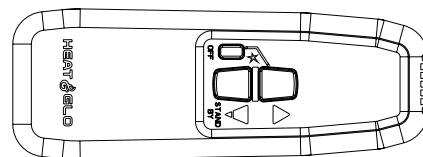
- This heater is equipped with an ignition device which automatically lights the burner. Do not try to light the burner by hand.
- Wait five (5) minutes to clear out any gas. Then smell for gas, including near the floor. If you smell gas, STOP! Follow "B" in the Safety Information located on the left side of this page. If you don't smell gas, go to next step.



- To light the burner, simultaneously press the star  and up  arrow buttons on the remote control until a short acoustic signal confirms the start sequence has begun.
- If the heater will not operate, check the batteries then follow the instructions "To Turn Off Gas to Heater" and call your service technician or gas supplier.

TO TURN OFF GAS TO HEATER

- Push the 'OFF' button on remote.
- Remove batteries from receiver.



C. After Appliance is Lit

Initial Break-in Procedure

When you light the appliance, you may notice that it produces heat which does have an associated odor or smell. If you feel this odor is excessive it may require the initial three to four hour continuous burn on high followed by a second burn up to 12 hours to fully drive off any odor from paint and lubricants used in the manufacturing process. Condensation of the glass is normal.



NOTE: The appliance should be run three to four hours on the initial start-up. Turn it off and let it cool completely. Remove and clean the glass. Replace the glass and run the appliance for an additional 12 hours. This will help to cure the products used in the paint and logs.

During this break-in period it is recommended that some windows in the house be opened for air circulation. This will help avoid setting off smoke detectors, and help eliminate any odors associated with the appliance's initial burning.

 WARNING	
	<p>Fire Risk. High Temperatures. Keep combustible household items away from appliance. Do NOT obstruct combustion and ventilation air.</p> <ul style="list-style-type: none"> Do NOT place combustible items on top of or in front of appliance. Keep furniture, draperies away from appliance.

CAUTION
<ul style="list-style-type: none"> Prevent accidental appliance operation when not attended. Unplug or remove batteries from remote control if absent or if appliance will not be used for an extended period of time. Property damage possible from elevated temperatures.

CAUTION
<p>Smoke and odors released during initial operation.</p> <ul style="list-style-type: none"> Open windows for air circulation. Leave room during initial operation. Smoke may set off smoke detectors. <p>Smoke and odors may be irritating to sensitive individuals.</p>

 WARNING	
	<p>Fire Hazard. Keep combustible materials, gasoline and other flammable vapors and liquids clear of appliance.</p> <ul style="list-style-type: none"> Do NOT store flammable materials in the appliance's vicinity. Do NOT use gasoline, lantern fuel, kerosene, charcoal lighter fluid or similar liquids in this appliance. Combustible materials may ignite.

D. Frequently Asked Questions

ISSUE	SOLUTIONS
Condensation on the glass	This is a result of gas combustion and temperature variations. As the gas stove warms, this condensation will disappear.
Blue flames	This is a result of normal operation and the flames will begin to yellow as the gas stove is allowed to burn for 20 to 40 minutes.
Odor from gas stove	When first operated, this gas stove may release an odor for the first several hours. This is caused by the curing of the paint and the burning off of any oils remaining from manufacturing.
Film on the glass	This is a normal result of the curing process of the paint and logs. Glass should be cleaned within 3 to 4 hours of initial burning to remove deposits left by oils from the manufacturing process. A non-abrasive cleaner such as gas stove cleaner may be necessary. See your dealer. Ensure glass has cooled before cleaning.
Metallic noise	Noise is caused by metal expanding and contracting as it heats up and cools down, similar to the sound produced by a furnace or heating duct. This noise does not affect the operation or longevity of the gas stove.

9 Maintaining and Servicing Appliance

Although the frequency of appliance servicing and maintenance will depend on use and the type of installation, a qualified service technician should perform an appliance checkup at the beginning of each heating season.

⚠ WARNING

Risk of injury or property damage.

Before servicing:

- Turn off gas.
- Remove batteries from remote control to disable it.
- Ensure appliance is completely cooled.

After servicing:

- Replace any screen or barrier that was removed.
- Reinstall and reseal any flueing removed for servicing.
- Replace batteries in remote control.

A. Front Door Glass Assembly Removal

Remove the front door assembly by pulling bottom of front away from gas stove and lifting it off of the hooks on top of the gas stove (see **Figure 8.18**).

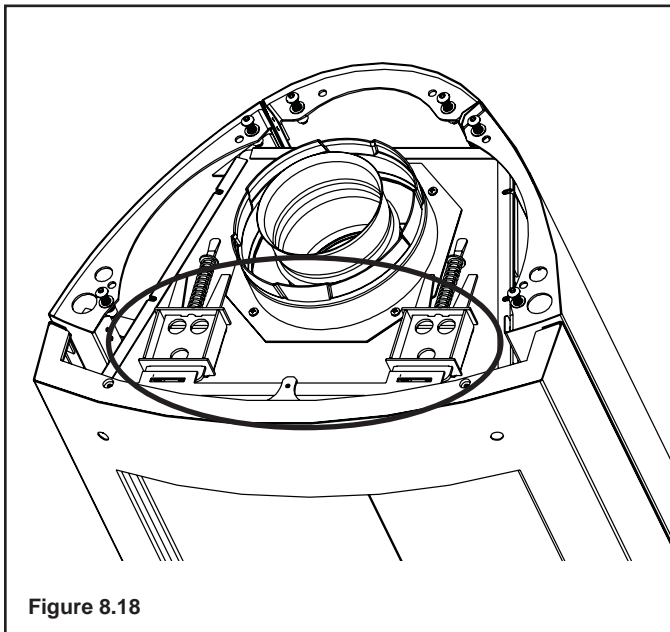

Figure 8.18

⚠ WARNING

Annual inspection by qualified technician recommended.

Check:

- Condition of glass, glass assembly and glass seal.
- Obstructions of combustion and ventilation air.
- Burner ignition and operation.
- Burner air shutter adjustment
- Gas connections and fittings.
- Obstructions of termination cap.

Clean:

- Glass
- Air passageways, grilles, control compartment
- Burner, burner ports

Risk of:

- Fire
- Delayed ignition or explosion
- Exposure to combustion fumes
- Odors



CAUTION

Handle glass assembly with care.

NOTE: Clean glass after initial 3-4 hours operation. **Longer operation without cleaning glass may cause a permanent white film on glass.**

When cleaning glass door:

- Avoid striking, scratching or slamming glass.
- Do NOT use abrasive cleaners.
- Use a hard water deposit glass cleaner on white film.
- Do NOT clean glass when hot.
- Turn off appliance after 3-4 hours of operation and **ALLOW TO COOL.**
- Remove and clean glass assembly.
- Replace glass assembly and operate appliance for additional 12 hours.

Refer to maintenance instructions.

⚠ WARNING



Inspect external vent cap regularly.

- Ensure no debris blocks cap.
- Combustible materials blocking cap may ignite.
- Restricted air flow affects burner operation.



B. Maintenance Tasks

Inspect	Maintenance Tasks
Doors	1. Inspect for scratches, dents or other damage and repair as necessary.
	2. Verify no obstructions to air flow.
	3. Verify maintenance of proper clearance to combustible household objects.
Gasket Seal, Glass Assembly and Glass	1. Inspect gasket seal and its condition.
	2. Inspect glass for scratches and nicks that can lead to breakage when exposed to heat.
	3. Confirm there is no damage to glass or glass frame, Replace as necessary.
	4. Verify that latches engage properly and glass attachment components are intact and operating properly. Replace as necessary.
	5. Clean glass. Replace glass assembly if severely coated with silicate deposits that cannot be removed.
Valve Compartment and Firebox Top	1. Vacuum and wipe out dust, cobwebs, debris or pet hair. Use caution when cleaning these areas. Screw tips that have penetrated the sheet metal are sharp and should be avoided.
	2. Remove any foreign objects.
	3. Verify unobstructed air circulation.
Logs	1. Inspect for broken, damaged, or missing logs. Replace as necessary.
	2. Verify correct log placement and no flame impingement causing sooting. Correct as necessary.
Firebox	1. Inspect for paint condition, warpage, corrosion or perforation. Sand and repaint as necessary.
	2. Replace gas stove if firebox has been perforated.
Burner Ignition and Operation	1. Verify burner is properly secured and aligned with pilot or igniter.
	2. Clean off burner top, inspect for plugged ports, corrosion or deterioration. Replace burner if necessary.
	3. Replace ember material with new 15 mm pieces. Do not block ports or obstruct lighting paths.
	4. Check for smooth lighting and ignition carryover to all ports. Verify there is no ignition delay.
	5. Inspect for lifting and other flame problems.
	6. Inspect orifice for soot, dirt or corrosion.
	7. Verify manifold and inlet pressures. Adjust regulator as required.
	8. Inspect pilot flame strength. Clean or replace orifice as necessary.
	9. Inspect thermocouple sensor rod for soot, corrosion and deterioration. Clean with emery cloth or replace as required.
	10. Verify millivolt output. Replace as necessary.
Flueing	1. Inspect flueing for blockage or obstruction such as bird nests, leaves, etc.
	2. Confirm that termination cap remains clear and unobstructed by plants, etc.
	3. Verify that termination cap clearance to subsequent construction (building additions, decks, fences or sheds) has been maintained.
	4. Inspect for corrosion or separation.
	5. Verify weather stripping, sealing and flashing remains intact.
Remote Control	1. Verify operation of remote.
	2. Replace batteries in remote transmitters and battery-powered receivers.

10 Troubleshooting

With proper installation, operation, and maintenance your gas appliance will provide years of trouble-free service. If you do experience a problem, this troubleshooting guide will assist a qualified service person in the diagnosis of a problem and the corrective action to be taken. This troubleshooting guide can only be used by a qualified service technician.

A. Electronic Ignition System

Symptom		Possible Causes	Corrective Actions
1.	No transmission, motor does not turn.	A. Receiver must learn new code.	Press and hold the receiver's reset button until you hear 2 acoustic signals. After the second longer acoustic signal, release the reset button and within the subsequent 20 seconds, press the down arrow on the remote handset until you hear an additional long acoustic signal confirming the new code is set.
2.	No ignition. No tone.	A. Receiver	Replace receiver and reprogram code.
3.	No ignition; one 5 seconds continuous tone (7 shorts beeps might be heard prior to the 5 seconds tone).	A. ON/OFF switch is in OFF position.	Push switch to ON position.
		B. Loose wire.	Secure wire.
		C. Receiver.	Replace receiver and reprogram.
		D. Bent pins on 8 wire connector.	Straighten pins on 8 wire connector.
		E. Valve.	Replace valve.
4.	No pilot flame and control continues to spark.	A. Air in the pilot supply line.	Purge the line or start ignition several times.
		B. Thermocouple circuit wired incorrectly.	Check polarity of the thermocouple wires.
		C. No spark at pilot burner.	Check spark gap, check wiring connection. Check for spark in location along cable.
		D. Valve.	Replace valve. Do not over tighten.
		E. Over tightened thermocouple interrupter.	Replace valve and thermocouple interrupter.
		F. Receiver.	Replace receiver and reprogram code.
5.	Pilot is lit and control continues to spark. Valve shuts off after 10-30 seconds. Valve operates manually.	A. Receiver.	Replace receiver and reprogram code.
6.	Pilot is lit, sparking stops if a flame is present. Valve shuts off after 10-60 seconds. Valve does not work manually.	A. Thermocouple.	Replace thermocouple.
		B. Low inlet pressure to valve.	Confirm sufficient inlet pressure to the valve. Adjust or replace inlet regulator if necessary.
		C. Valve.	Replace valve. Do not tighten the thermocouple interrupter.
7.	3 short beeps while the motor turns.	A. Batteries are low.	Replace batteries - quality alkaline recommended. WARNING: Creating an electrical short between the batteries/battery box and metal parts of the appliance may render the receiver inoperable.
8.	Pilot flame lights but there is no main gas flow.	A. Manual override know (if equipped) is in MAN position.	Turn Manual override know to ON position.
		B. Valve turned don to pilot flow.	Turn flame to high fire by pressing up button on remote handset.
		C. Low inlet pressure to valve.	Confirm sufficient inlet pressure to the valve. Adjust or replace inlet regulator if necessary.
		D. Valve.	Replace valve.
9.	Pilot sparks, but pilot will not light.	A. Correct gas supply.	Verify that incoming gas line ball valve is "open". Verify that inlet pressure reading is within acceptable limits, inlet pressure must not exceed 5 kPa.
		B. Ignitor gap is too large.	Verify that spark gap from ignitor to pilot hood is .43 cm.
		C. Module is not grounded.	Verify module is securely grounded to metal chassis of stove.

11 Reference Materials

A. Appliance Dimension Diagram Without Stone Surround

Dimensions are actual appliance dimensions. Use for reference only. For framing dimensions and clearances refer to Section 3.

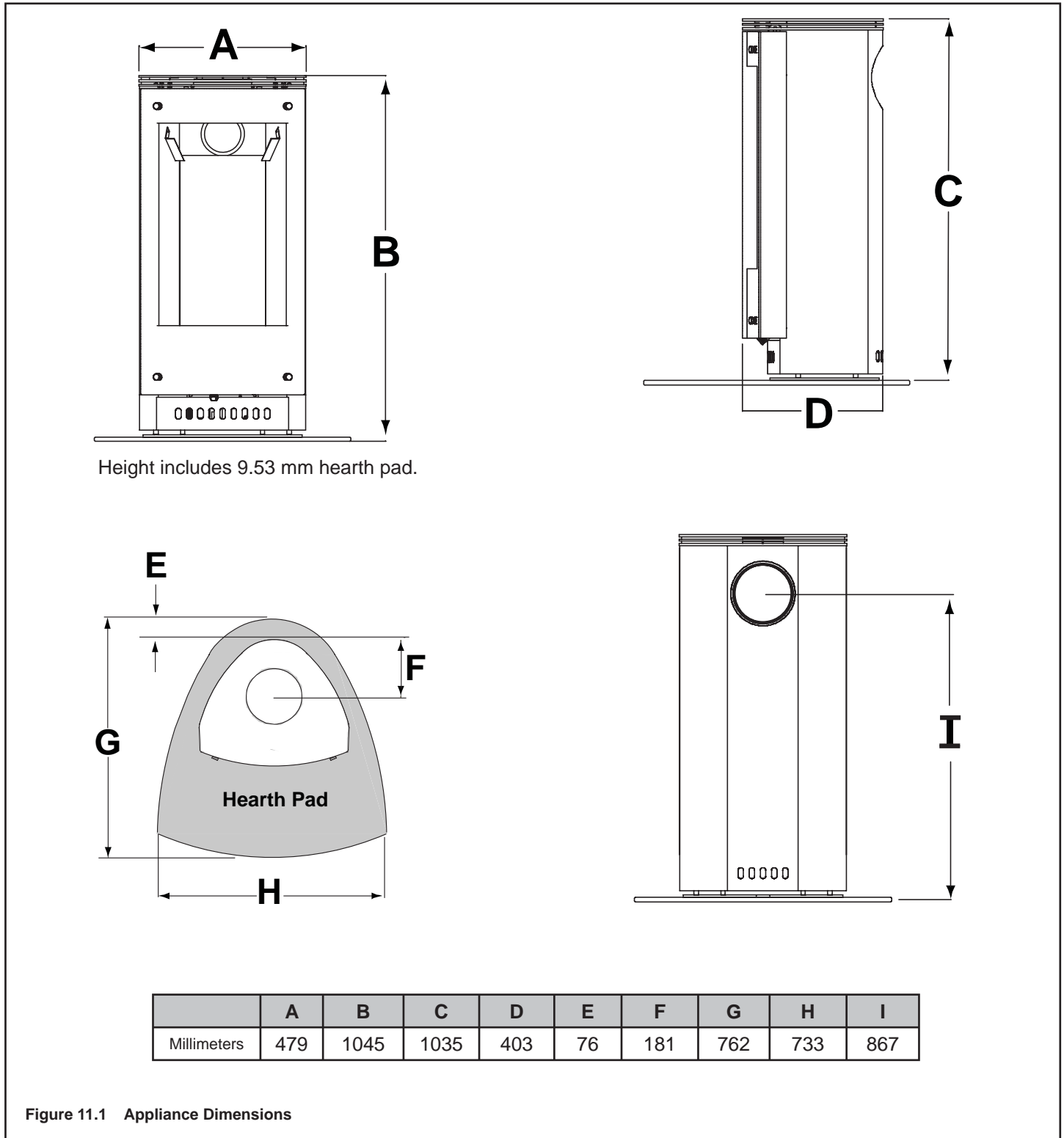

Figure 11.1 Appliance Dimensions

B. Appliance Dimension with Stone Surround Diagram

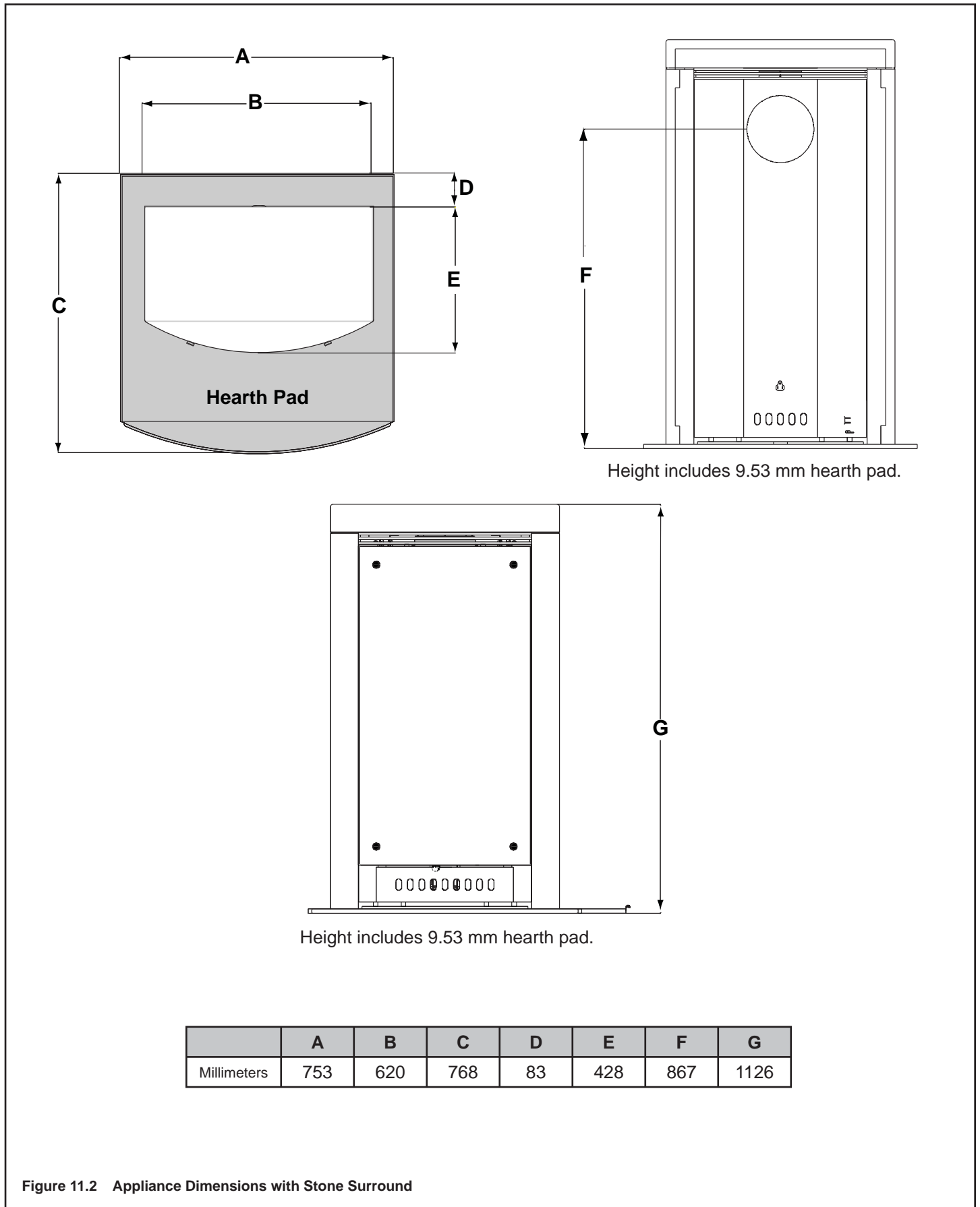
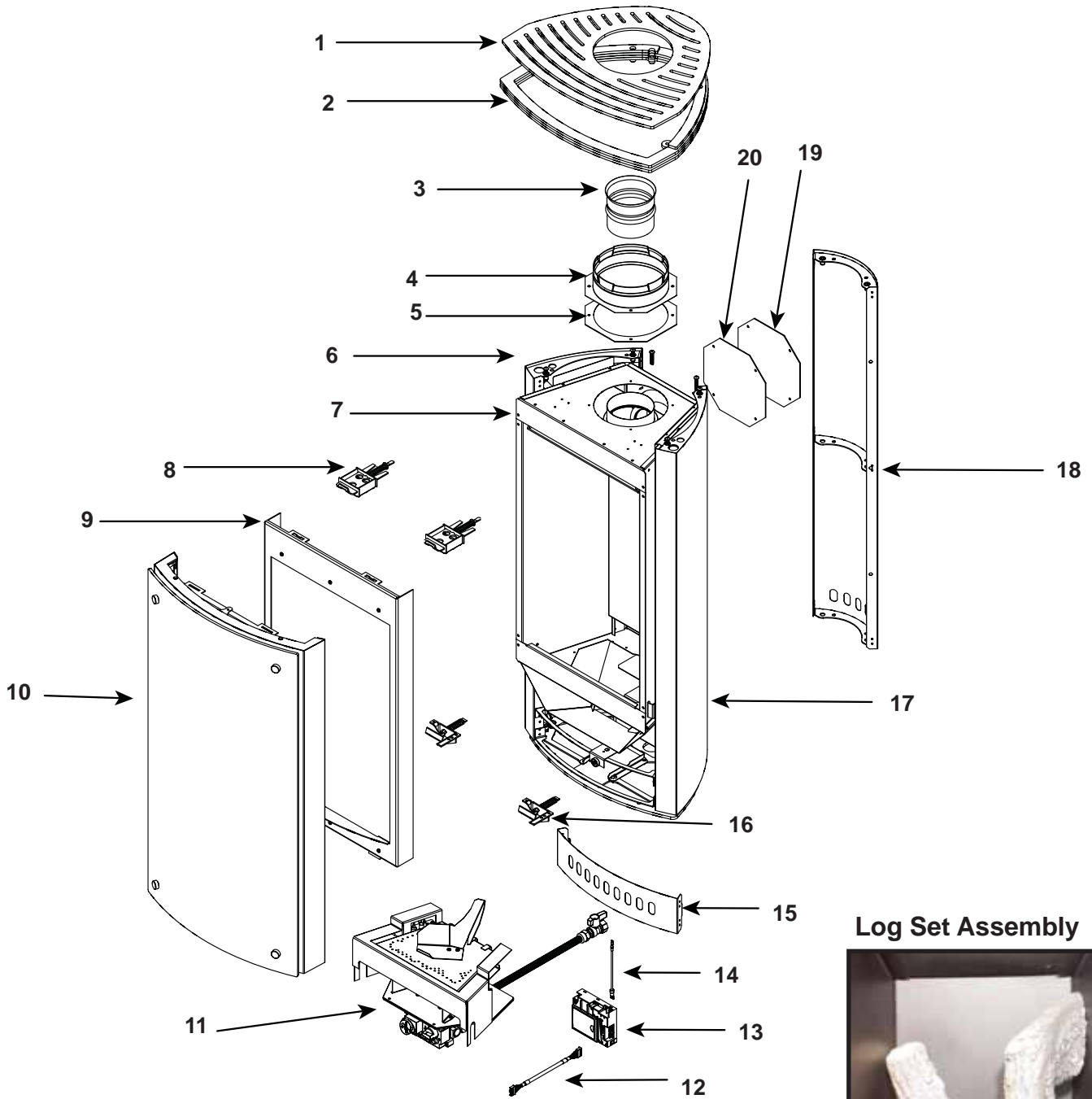

Figure 11.2 Appliance Dimensions with Stone Surround

C. Flue Components List

COMPONENTS	
Ceiling Support / Wall Thimble, Black	656-230
150 mm Pipe Length, Black	908B
220 mm Pipe Length, Black	907B
310 mm Pipe Length, Black	906B
600 mm Pipe Length, Black	904B
910 mm Pipe Length, Black	903B
1210 mm Pipe Length, Black	902B
280 - 370 mm Pipe Length, Black	911B
310 - 430 mm Pipe, Adjustable, Black	912B
90 degree Elbow, Black	990B
150 mm Pipe	SL-06D
220 mm Pipe	SL-09D
310 mm Pipe	SL-12D
600 mm Pipe	SL-24D
910 mm Pipe	SL-36D
1210 mm Pipe	SL-48D
90 degree Elbow	SL-90D
Storm Collar	SL-SCD
Ceiling Firestop	SL-FCD
Wall Firestop	SL-FWD
Pipe Support Strap	SL-PSD
Decorative Radius Cover	DRC-RADIUS
Slim Line Heat Shield	HTI-DV-WT
TERMINATION KITS	
Trapezoid Termination Kit 197 mm - 280 mm, 2 Firestops	SLK-01TRD
Vertical Termination Cap - High Wind	SLK-991DA



Log Set Assembly



Part number list on following page.

IMPORTANT: THIS IS DATED INFORMATION. The most current information is located on your dealers' VIP site. When ordering, supply serial and model numbers to ensure correct service parts.

ITEM	DESCRIPTION	SERIAL #	PART NUMBER
	Log Set Assembly		7031-033
1	Removable Top		2123-012
2	Top Assembly		7031-013
3	Adaptor 4 inch flue collar		200-2470
4	DV Adaptor		7000-162
5	Adaptor Gasket		460-0610
6	Side Assembly Left		2123-027
7	Firebox Assembly		2123-004
	Heat Shield		2123-124
8	Latch Assembly Upper		2123-120
9	Glass Frame Assembly		2123-005
10	Front Door Assembly, Bronze		2123-028
	Front Door Assembly, Gray		2123-016
11	Firebox Bottom Assembly N		2123-002
	Firebox Bottom Assembly P		2123-003
12	Control Cable, 8 Pin Connector		2098-143
13	Control Module		2098-142
14	Control Wire		2098-148
15	Access Door assembly		7031-023
16	Latch Assembly Lower		386-122A
17	Side Assembly Right		2123-026
18	Back Panel Assembly		7031-021
19	Cover Plate		7010-159
20	Cover Plate Gasket		7010-160
	Bottom Plate Assembly		2123-015
	Blower Bracket		7000-194
	Air Deflector		2123-157
	Multi-Function Remote		REM-DLX-CE
	Multi-Function Wall Switch		WSK-DLX-CE
	Front Glass, Gray		PAL-GLS-GY
	Front Glass, Bronze		PAL-GLS-BZ
	Hearth Pad, Gray		HP-PAL-GY
	Hearth Pad, Bronze		HP-PAL-BZ
	Blower With Rheostat		GFK-240V
	Adaptor Plug 240V-6V		2098-144
	Power Cord-240V		546-251A
	Top Vent Conversion Kit		TR-VRT-AU
	Touch Up Paint (Pewter)		TUPP-12
	Conversion Kit (N to P)		N2P-VRT-AU
	Conversion Kit (P to N)		P2N-VRT-AU
	Pilot Orifice N		2098-518
	Pilot Orifice P		2098-512

Additional service part numbers may appear on following page.

Valve Assembly

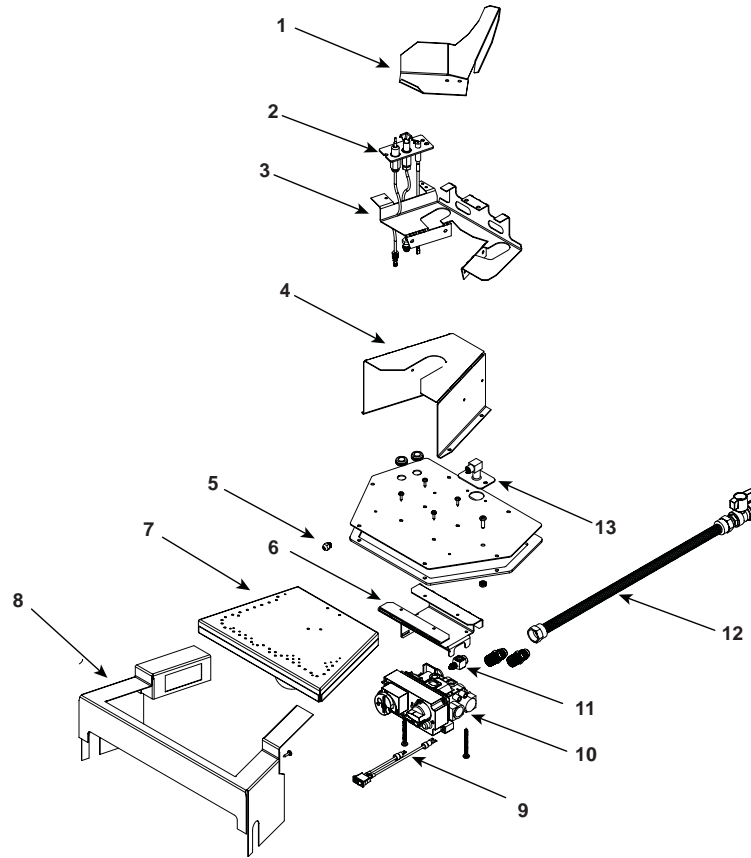

IMPORTANT: THIS IS DATED INFORMATION. The most current information is located on your dealers' VIP site. When ordering, supply serial and model numbers to ensure correct service parts.

ITEM	DESCRIPTION	SERIAL #	PART NUMBER
1	Log Bracket		7031-282
2	Pilot Assembly N		2098-050
	Pilot Assembly P		2098-051
3	Pilot Bracket		7031-280
4	Burner Support		7031-279
5	Orifice N (#39C)		582-839
	Orifice P (.057C)		582-057
6	Valve Bracket		2111-186
7	Burner N		2123-017
	Burner P		2123-022
8	Burner Shelf		2123-126
9	Switch Assembly, Maxitrol		2098-145
10	Valve N		2098-130
	Valve P		2098-131
11	Thermocouple Block		2098-146
12	Flex Gas Connector		2098-022
13	Flex Tube Assembly		7000-156

E. Warranty Policy

HEAT & GLO LIMITED 10 YEAR WARRANTY



In order to presumptively establish the dates to which your HEAT & GLO Limited Warranty runs, you must mail the completed warranty card to HEAT & GLO, 20802 Kensington Boulevard, Lakeville, MN 55044, USA, within 60 days of the date of the stove installation. If you fail to do so, you may be required to prove the date of installation before warranty work can be performed.

The warranty exclusions and limitations of liability are effective upon installation of the stove.

Subject to the conditions set forth herein, HEAT & GLO, a brand of Hearth & Home Technologies, Inc. ("HEAT & GLO") extends the following warranty with respect to HEAT & GLO.

If HEAT & GLO is reasonably satisfied that any part or portion of the stove covered by this Limited Warranty is defective in material or workmanship under normal use and service as described in the User's Manual, HEAT & GLO will take the following actions:

1. If the defect is reported during the first year from the date of installation (stainless steel burners and fiber logs are covered for 3 years), HEAT & GLO will replace or repair the defective components at its sole expense. The decision whether to replace a component shall be made at HEAT & GLO's sole discretion. This Limited Warranty does not cover components broken during shipping, misuse or careless handling. HEAT & GLO shall not be responsible for any indirect, incidental, or consequential damages or for any costs other than those incurred by HEAT & GLO to repair or replace the defective component. If components (including venting) other than factory approved components are used, all warranty and liability on the stove is voided. Defects reported after the first year will not be covered by warranty unless they fall within the purview of paragraph 2 or 3 below.
2. If the following defects are reported during the second year after the date of installation, HEAT & GLO will supply replacement parts at the current wholesale price: defective electrical or manual components, optional components or accessories, and glass panels (not including glass panels broken during misuse or careless handling). HEAT & GLO shall not be responsible for any labor, transportation or other costs. Furthermore, it shall not be liable for any indirect, incidental or consequential damages.
3. HEAT & GLO will replace or repair a defective firebox or heat exchanger, at any time during the 10 years from the date of installation. The decision whether to replace the defective component shall be made at HEAT & GLO's sole discretion. HEAT & GLO shall not be responsible for any indirect, incidental or consequential damages or for any costs other than those incurred by HEAT & GLO to repair or replace the defective component.

This Limited Warranty is the exclusive remedy available to you. If HEAT & GLO cannot effectively resolve a warranty problem in an expedient and cost-effective manner, it can discharge its entire warranty liability by refunding the price of the product to you.

Products made by other manufacturers, whether sold with the stove or added thereafter, are NOT covered by this Limited Warranty. The use of other unauthorized components will make this warranty null and void. This Limited Warranty will also be void if the appliance is not installed by a qualified installer in accordance with the Installation Instructions. Furthermore, the Limited Warranty will be void if the stove is not operated, at all times, according to the User's Manual furnished with the stove. Any service work must be performed by authorized service representatives.

EXCEPT TO THE EXTENT PROVIDED BY LAW, NO OTHER EXPRESS OR IMPLIED WARRANTIES, INCLUDING WARRANTIES OF MERCHANTABILITY OR FITNESS FOR A PARTICULAR PURPOSE, SHALL APPLY TO THE FIREPLACE PRODUCT. In States that do not allow limitations on how long an implied warranty lasts, or do not allow exclusion of indirect damages, those limitations or exclusions may not apply to you. You may also have additional rights not covered in this Limited Warranty.

HEAT & GLO reserves the right to make changes at any time, without notice, in design, material, specifications and prices. It also reserves the right to discontinue styles and products.

Please complete this information and retain this warranty in a safe place for future reference:



Installation Date: _____ Model # _____ Serial # _____ Installing Contractor: _____

F. Contact Information



Where everything comes together

Heat & Glo, a brand of Hearth & Home Technologies, Inc.
20802 Kensington Boulevard
Lakeville, MN 55044, USA

	CAUTION
	Do NOT discard this manual. <ul style="list-style-type: none">• Important operating and maintenance instructions included.• Read, understand and follow these instructions for safe installation and operation.• Leave this manual with party responsible for use and operation.

Please contact your Heat & Glo dealer with any questions or concerns.
For the location of your nearest Heat & Glo dealer, please visit www.heatnglo.com

For Service or Replacement Parts Contact:

Melbourne
Jetmaster
444 Swan Street
Richmond 3121
(03) 9429-5573

Perth
Fireplace Corner
277 Lord Street
East Perth 6000
(08) 9228-2600

Sydney
Jetmaster
10 Martin Avenue
Arncliffe 2205
(02) 9597-7222



Your Records for Model:

VRTIKL-AU Balanced Flue Gas Appliance

DEALERSHIP WHERE PURCHASED:

SERIAL NUMBER: _____

DATE PURCHASED: _____

DATE INSTALLED: _____

DEALER TELEPHONE: _____

THIS PRODUCT MAY BE COVERED BY ONE OR MORE OF THE FOLLOWING PATENTS:

(United States) 4593510, 4686807, 4766876, 4793322, 4811534, 5000162, 5016609, 5076254, 5113843, 5191877, 5218953, 5263471, 5328356, 5341794, 5347983, 5429495, 5452708, 5542407, 5601073, 5613487, 5647340, 5688568, 5762062, 5775408, 5890485, 5931661, 5941237, 5947112, 5996575, 6006743, 6019099, 6048195, 6053165, 6145502, 6170481, 6237588, 6296474, 6374822, 6413079, 6439226, 6484712, 6543698, 6550687, 6601579, 6672860, 6688302B2, 6715724B2, 6729551, 6736133, 6748940, 6748942, D320652, D445174, D462436; (Canada) 1297749, 2195264, 2225408; (Australia) 543790;586383; (Mexico) 97-0457; (New Zealand) 200265; or other U.S. and foreign patents pending.