

AEG

# LAVAMAT 61-81-102

Ekolojik Otomatik amařır Makinesi  
The environmentally friendly washing-machine

Kullanım kılavuzu  
Instruction booklet

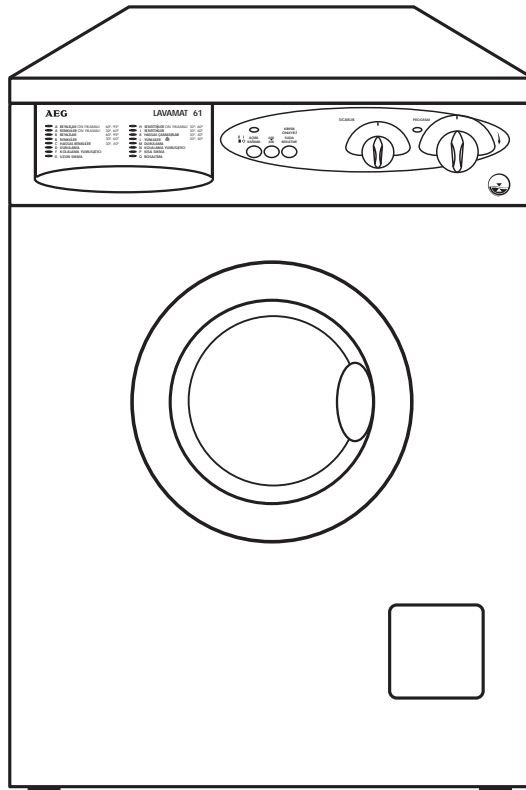

AUS ERFAHRUNG GUT

## Dear customer,

Please read these operating instructions carefully and pay particular attention to the safety notes indicated in the first pages. We recommend that you keep this instruction booklet for future reference and pass it on to any future owners.

 The warning triangle and/or the key words (Warning!, Caution!) emphasize information that is particularly important for your safety or correct functioning of the appliance.

 This symbol guides you, step by step, in the operation of the appliance.

 The information marked with this symbol provides additional instructions and practical tips on the use of the appliance.

 Tips and information about economical and ecological use of the machine are marked with the clover symbol.

Should any problems arise, this booklet provides instructions on how to solve them by yourself; see section "Something not working?".

If this information is not sufficient, please contact our nearest Service centre (address and telephone numbers are indicated on the enclosed leaflet).

Printed on recycled paper.  
People who think ecologically, act accordingly...

# Contents

<b>Safety instructions</b> .....	41
<b>Discarding</b> .....	43
<b>Tips for environmental protection</b> .....	44
<b>Main features of your washing machine</b> .....	45
<b>Description of the appliance</b> .....	46
Control panel .....	47
Programme selector dial .....	47
Temperature selector dial .....	47
ON/OFF button (AÇMA KAPAMA) .....	48
Spin reduction button .....	48
Anticrease button (stop with water in drum) KIRIÇIK ÖNLEYİCİ (SUDA BEKLETME) .....	48
Mains-on light .....	48
Detergent and additive dispenser drawer .....	49
<b>Before the first wash</b> .....	49
<b>Preparing the wash cycle</b> .....	50
Sorting out and preparing the laundry .....	50
Weight of laundry .....	51
Types of fabric and care labels .....	51
Detergents and additives .....	53
Which detergent and additive? .....	53
How much detergent? .....	53
Liquid detergent .....	53
Adding a water softener .....	53
Information on water hardness .....	53
<b>How to wash</b> .....	54
Load the laundry .....	54
Add detergent and additive .....	54
Select the wash programme and temperature .....	54
Select the required option .....	55
Start the programme .....	55
End of the programme .....	55
<b>Programme charts</b> .....	56-57
<b>Consumption data and duration of main programmes</b> .....	58

## Contents

<b>Cleaning and maintenance</b> .....	59
After each use .....	59
Periodical cleaning .....	59
Bodywork .....	59
Detergent dispenser drawer .....	59
Drain filter .....	60
Water inlet filter .....	60
Emergency emptying out .....	61
Frost precautions .....	61
<b>Something not working?</b> .....	62
Troubleshooting .....	62
Unsatisfactory washing results .....	65
<b>Technical data</b> .....	66
<b>Service</b> .....	67
<b>Instructions for installation and electrical connection</b> .....	68
Safety instructions .....	68
<b>Dimensions of the appliance</b> .....	69
Front view and side view .....	69
Rear view .....	69
<b>Installation</b> .....	70
Unpacking .....	70
Positioning .....	71
Levelling .....	71
Water inlet .....	72
Water drainage .....	72
Electrical connection .....	73
Permanent connection .....	73



## Safety instructions

The safety of AEG appliances complies with the industry standards and with legal requirements on the safety of appliances. However, as manufacturers, we feel it is our duty to provide the following safety notes.

### General notes

- Repairs to the machine must be carried out only by qualified personnel. Repairs carried out by inexperienced persons could cause serious danger. Contact our Service Centre or your AEG dealer.
- Never start the machine if the electrical supply cable is damaged or the control panel or worktop are so damaged that inner components can be reached.
- Unplug the appliance before carrying out any cleaning or maintenance operations.
- Never pull the power supply cable to remove the plug from the socket; always take hold of the plug itself.
- Never spray the washing machine with a jet of water. Danger of electrocution!
- During high temperature wash programmes the door glass may get hot. Do not touch it!
- Let the water cool down before carrying out emergency emptying or before opening the door in an emergency.
- Small animals can gnaw electric wires and water hoses causing electrocution hazard and damage due to water leaks.

### Positioning, connection, starting up

- Follow the **instructions for positioning and connection**.
- Carry out a first wash without laundry (COTTONS 60, with half the amount of detergent) in order to remove any manufacturing residue from the tub and the drum.
- Should the machine be purchased in winter, when temperatures can be below 0°, leave the appliance for 24 hours at ambient temperature before starting it.

## Safety instructions

**Child safety**

- Children are often not aware of how dangerous electrical appliances can be. When the machine is working, they should be carefully supervised and not be allowed to play with the appliance - there is a risk that they could become trapped inside.
- The packaging components (e.g. plastic film, polystyrene) can be dangerous to children - danger of suffocation! Keep them out of children's reach.
- Make sure that children or pets do not climb into the drum.
- When the appliance is disposed of, pull the plug out of the socket, cut off the electrical supply cable and destroy the plug with the remaining cable. Disable the door catch in order to prevent children from becoming trapped inside while playing.

**Proper use**

- This appliance is designed for domestic use only. If the machine is used for any other purposes or is not used correctly, the manufacturer accepts no responsibility for any possible damage that might occur.
- For safety reasons, the appliance must not be modified.
- Use only detergents suitable for washing machines and follow the manufacturer's instructions.
- Laundry must not have any trace of inflammable solvents; be particularly careful when washing items that have been previously dry cleaned.
- Dyes and bleaching agents may only be used if specifically permitted by the manufacturer of these products. We cannot be held responsible for any damage.
- Use only water supplied from the rising mains. Rainwater or industrial water may only be used if the requirements of standards DIN 1986 and DIN 1988 are complied with.



## Discarding

### Packaging materials

The materials marked with the symbol  are recyclable.

This means that they can be recycled by disposing of them properly in appropriate collection containers.

For information regarding waste collection points, please contact your local authorities.

>PE<=polyethylene

>PS<=polystyrene

>PP<=polypropylene

### Machine

To dispose of the appliance correctly, contact the local body responsible for collection.



## Tips for environmental protection

- Lightly soiled laundry may be washed without prewashing in order to save detergent, water and time (the environment is protected too!).
- The machine works more economically if it is fully loaded.
- When small loads are washed, use only half to two thirds of the recommended amount of detergent.
- With adequate pre-treatment, stains and limited soiling can be removed; the laundry can then be washed at a lower temperature.
- Try not to use fabric softeners. If the laundry is machine dried, it will remain soft even without using fabric softeners.
- If the water has a medium or high degree of hardness (starting from degree of hardness II, see "Detergents and additives") water softeners must be added.
- The amount of detergent can then be adjusted to degree of hardness I (= soft).



## Main features of your washing machine

- Temperature regulated by selector knob.
- The speed of the final spin can be reduced both with cottons and with synthetics, delicates and woollens.
- The **stop with water in drum** function can be selected for synthetics, delicates and woollens: the laundry is left immersed in the final rinse water to avoid the formation of creases.
- Because of its gentle washing action, the **special wool cycle** washes your garments with extreme care, without felting them.
- **3-compartment drawer** for detergent and fabric softener.
- **Unbalance detection device**: secure position and silent operation of the appliance.

# Description of the appliance

## Front view

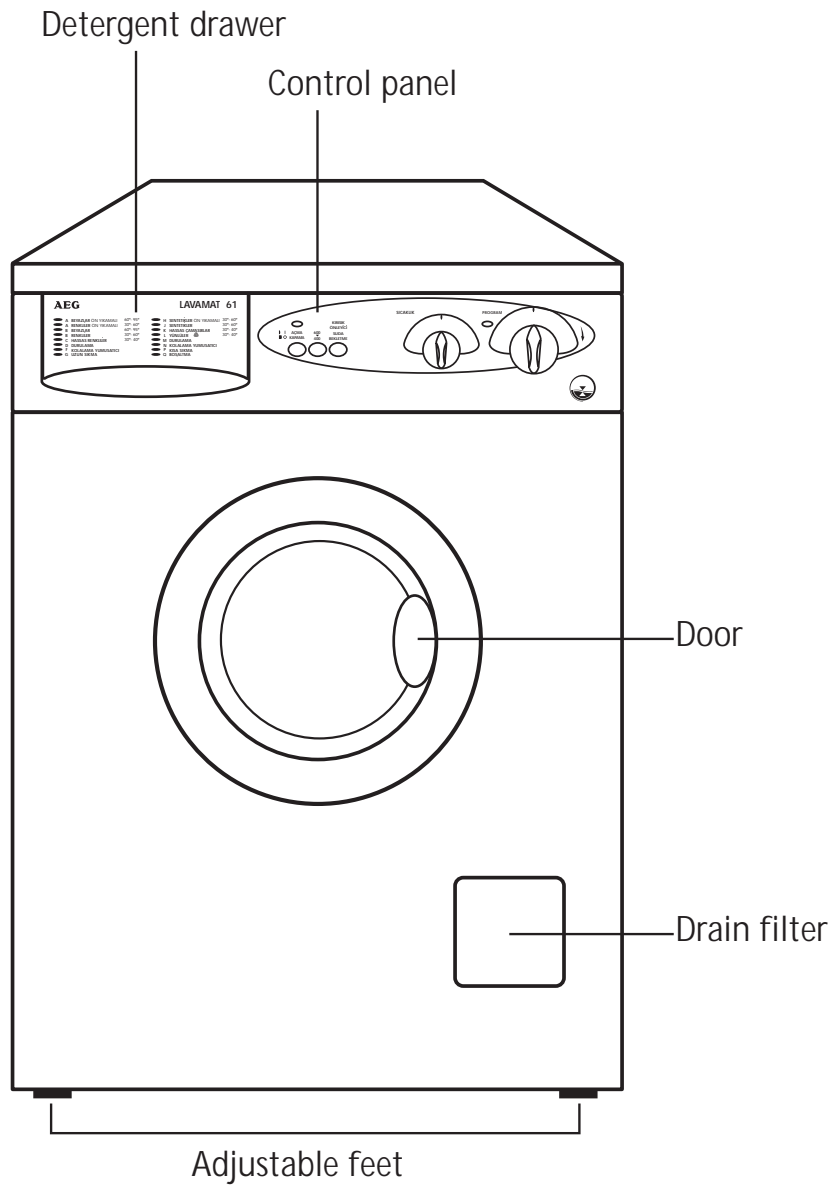

## Control panel

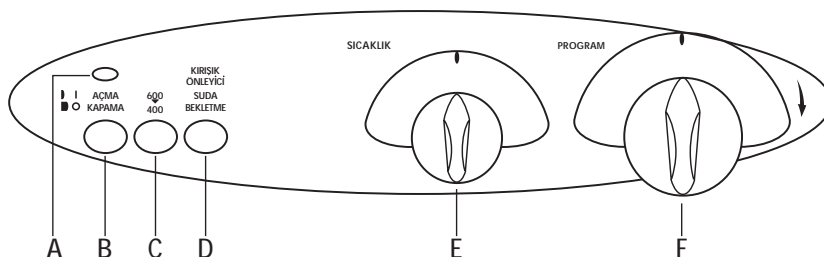

- A = Mains-on light
- B = ON/OFF button
- C = Spin reduction button
- D = Anticrease button (stop with water in drum)
- E = Temperature selector dial
- F = Programme selector dial

### Programme selector dial

The programme selector determines the type of washing cycle (e.g. water level, drum movement, number of rinses, spin speed) according to the type of laundry.

**Warning!** It must only be turned clockwise.



### Temperature selector dial

Graduated from COLD (SOĞUK) to 95°C it enables selection of the most suitable temperature for each type of laundry.

It can be turned clockwise and anticlockwise.

In the COLD position, the machine operates with cold water. This is particularly recommended for very delicate items, such as curtains.

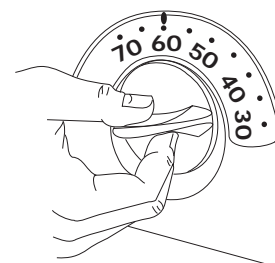

## Description of the appliance

**ON/OFF button (AÇMA KAPAMA) **

Press this button to start the programme. Press it again to interrupt the programme and to switch the machine off at the end of the programme.

**Warning!**

**Before selecting a programme or modifying a programme already started, the machine must be switched off by pressing the ON/OFF button.**

**Spin reduction button **

When this button is pressed, the spin speed will be reduced to 600 or 400 rpm (according to the model) in programmes for cottons and to 400 rpm in programmes for synthetics, delicates and woollens.

**Antcrease button (stop with water in drum) KIRIÇIK****ÖNLEYİCİ (SUDA BEKLETME)**

When this button is pressed with programmes H-J-K-L-M-N, the last rinse water is not emptied out, to prevent the fabrics from creasing.

To empty out water:

- press the button again: the machine will perform a short spin after emptying.
- Select the drain programme **Q**.

If the button is **not** pressed, at the end of the programme the machine will perform a short spin at 550 rpm, or at 400 rpm if the spin reduction button is pressed.

**Mains-on light**

This light comes on when the ON/OFF (AÇMA KAPAMA) button is pressed, and goes out at the end of the cycle.

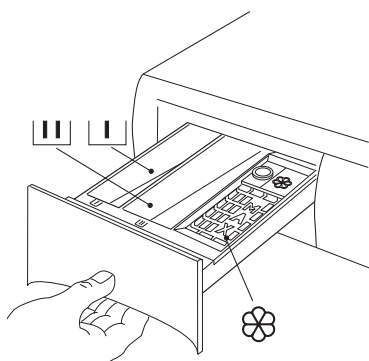

## Detergent and additive dispenser drawer

Lavamat 61-81

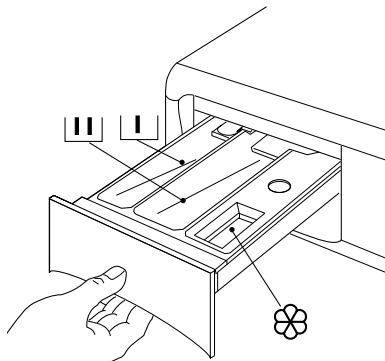

Lavamat 102



-  Compartment for prewash detergent. It is emptied at the beginning of the wash programme.
-  Compartment for powder or liquid detergent used for main wash. It is emptied at the beginning of the wash cycle.
-  Compartment for liquid additives (fabric softener, starch). It is emptied at the last rinse.

**The quantity of additives must not exceed the «MAX» mark in the drawer.**

## Before the first wash

Before your first wash, we recommend that you run a cotton cycle at 60°C, **without any laundry in the machine**, to remove any manufacturing residue from the drum and tub.

Pour 1/2 a measure of detergent into the dispenser drawer and start the machine.

## Preparing the wash cycle

### Sorting out and preparing the laundry

- Sort out the laundry according to type of fabrics and care labels (see "Types of fabric and care labels").
- Empty pockets.
- Remove any metal parts (safety pins, clips, etc.).
- To prevent the laundry from getting damaged and forming bundles, it is advisable to close zips, button up pillowcases and quilt covers and tie up loose straps such as those of aprons.
- Turn double faced items inside out (sleeping bags, anoraks, etc.)
- Turn coloured knitted fabrics, woollens and fabrics with trim inside out.
- Wash small and delicate items (baby socks, tights) inside a laundry net or in a pillow case closed with a zip, or in larger socks.
- Treat curtains with special care. Remove all metal or plastic hooks or put them in a net or a bag. We decline any responsibility in case of damage.
- Whites and coloureds must be washed separately: white items can lose their whiteness.
- New coloured fabrics often have excess dyes; it is advisable to wash them separately for the first time.
- Wash small and large items together; this improves the washing result and the laundry is better distributed during spinning.
- Shake out garments before putting them into the machine.
- Insert each garment separately.

## Weight of laundry

Sort of laundry	Approximate dry weights
Bathrobes	1200 g
Work shirts	300-600 g
Quilt covers	700 g
Sheets	500 g
Blouses	100 g
Hand towels	200 g
Tea towels	100 g
Shirts	200 g
Pillowcases	200 g
Night-gowns/Pyjamas	200-250 g
Tablecloths	200-300 g
Underwear	250 g

## Types of fabric and care labels

The labels on garments help you to select the most suitable wash programme. The laundry should be sorted out according to the type of fabric and the instructions indicated on care labels.

Temperatures indicated on labels are always maximum temperatures.

### Whites

Linen and cottons marked with this symbol can be washed at high temperatures.

### Coloureds

Linen and cottons marked with this symbol are colourfast and can be washed at 60°C.

### Coloureds

Garments marked with these symbols have delicate colours, therefore the washing temperature must not exceed these values.

### Synthetics

Mixed and synthetic fabrics marked with these symbols require a delicate wash programme and they must therefore be washed using the specific programme.

## Preparing the wash cycle

**Delicates**  

Microfibres, synthetics or curtains marked with these symbols require a particularly delicate treatment.



The DELICATES programme (HASSAS ÇAMAÇIRLAR) is suitable for this type of fabric.

**Woollens and particularly delicate items** 

Fabrics such as wool, wool mix or silk marked with this symbol are particularly sensitive to machine washing.

The WOOLLENS programme (YÜNLÜLER) is suitable for this type of fabric.

Fabrics marked with the  symbol (wool) can be machine washed only if the label indicates "does not felt" or "machine washable".

If the label has the symbol  (hand wash) or  (do not wash), garments must not be machine washed!



## Detergents and additives

### Which detergent and additive?

Use only detergents and additives for washing machines. Follow the manufacturer's instructions.

### How much detergent?

The quantity depends on:

- the load:  
if the manufacturer does not provide any indications on the amount of detergent for small loads, use about one third less than the suggested amount for half loads and half the amount for very small loads;
- the degree of soil:  
use a small amount of detergent for lightly soiled garments. Judge the amount according to the detergent manufacturer's instructions and size of the load;
- the water hardness:  
the harder the water, the more detergent required. Instructions according to water hardness are given on the detergent pack.

### Liquid detergent

Liquid detergent can be poured directly into the main wash compartment of the dispenser drawer **immediately** before starting the programme, or a special dispenser can be used that is placed directly in the drum. Measure the detergent according to the manufacturer's instructions.

### Adding a water softener



A water softener must be added when water has a medium-high degree of hardness (from degree of hardness II). Follow the manufacturer's instructions. The quantity of detergent can then always be adjusted to degree of hardness I (= soft). Information on water hardness can be obtained from your local water supply authority.

### Information on water hardness



Degree of hardness	German degrees °dH	French degrees °TH
I=Soft	0-7	0-15
II=Medium	7-14	16-25
III=Hard	14-21	26-37
IV=Very hard	more than 21	more than 37

## **i** How to wash

### Load the laundry



-  Open the door.
-  Place the laundry in the drum, one item at a time. Distribute laundry as evenly as possible. Close the door.

### Add detergent and additive

-  Pull the drawer out till it stops.
  -  Pour the main wash detergent into compartment III.
- If you wish to perform a pre-wash, pour detergent also into compartment II.

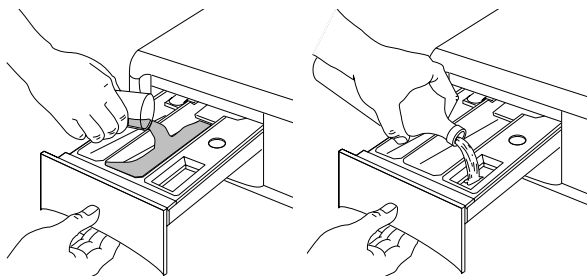
Lavamat 102



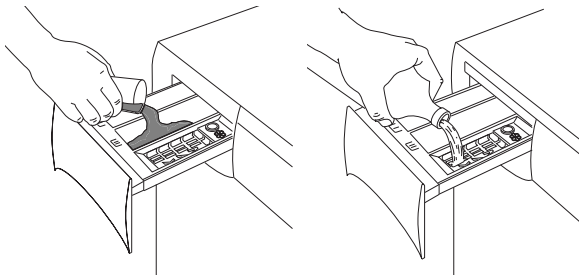

-  Pour the fabric softener into compartment  without exceeding the "MAX" mark.

Lavamat 61-81



-  Close the drawer, pushing it fully in.

### Select the wash programme and temperature

-  Turn the programme selector dial **to the right** to the required programme.
-  Turn the temperature selector dial to the required setting.

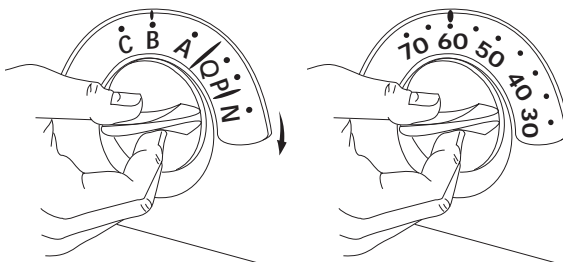

## Select the required option

-  Press the  $\frac{1000}{600}$   $\frac{800}{400}$   $\frac{600}{400}$  button according to the model or the anticrease button KIRIÇIK ÖNLEYICI (SUDA BEKLETME) if required.

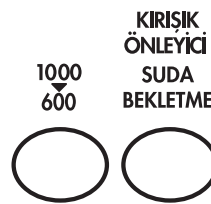

## Start the programme



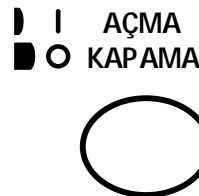



-  Press the ON/OFF (AÇMA KAPAMA) button: the mains-on light comes on and the programme starts.



## End of the programme

The machine stops automatically.

The mains-on light goes out.

-  If the anticrease option has been selected, empty out the water before opening the door:
- press the anticrease KIRIÇIK ÖNLEYICI(SUDA BEKLETME) button for a short spin after emptying, or
  - select the drain programme (BOÇALTMA).
-  Press the ON/OFF (AÇMA KAPAMA) button again to switch the machine off.
-  Release any buttons which have been pressed.
-  Open the door.  
Wait two minutes before opening the door to give the safety locking device time to release.
-  Remove the laundry.
-  Check that the drum is completely empty, by rotating it manually, in order to avoid any garments left in the drum being damaged (for example shrunk) during a subsequent wash, or their colour running into a subsequent load of laundry.
-  Close the water tap(s) and unplug the appliance. Leave the door ajar to let air circulate in the drum.

## Programme chart

### Energetic programmes for cottons and linen

Maximum load: 5 kg

Progr.	Temp.	Type of laundry	Cycle description	Possible option
A	60°-95°	Whites with prewash Beyazlar ön yıkamalı	Prewash Wash at 60°-95°C 4 rinses Long spin	1000 800 600 400 600 400
A	30°-60°	Coloureds with prewash Renkliler ön yıkamalı	Prewash Wash at 30°-60° C 4 rinses Long spin	1000 800 600 400 600 400
B	60°-95°	Whites Beyazlar	Wash at 60°-95°C 4 rinses Long spin	1000 800 600 400 600 400
B (*)	30°-60°	Fast coloureds Renkliler hızlı yıkama	Wash at 30°-60°C 4 rinses Long spin	1000 800 600 400 600 400
C	30°-40°	No fast coloureds Hassas renkliler	Wash at 30°-40°C 4 rinses Long spin	1000 800 600 400 600 400
D		Rinses Durulama	4 rinses with additive Long spin	1000 800 600 400 600 400
F		Rinse with softener Kolalama yumuşatıcı	1 Rinse with additive Long spin	1000 800 600 400 600 400
G		Long spin Uzun sıkma	Empty and long spin	1000 800 600 400 600 400

The temperatures indicated are the most suitable for each programme and depend on the type of laundry and the degree of soil.

(\*) Wash programme B at 60°C is the reference programme for the Energy Label data, in compliance with standard EEC 92/75.

## Programme chart

Delicate programmes for synthetics, mixed fabrics,  
delicates, woollens

Maximum load: 2 kg - wool 1 kg

Progr.	Temp.	Type of laundry	Cycle description	Possible option
H	30°-60°	Synthetics with prewash Sentetikler ön yıkamalı	Prewash Wash at 30°-60° C 3 rinses Short spin	Anti-crease Kırıcıık önleyici (Suda bekletme) 1000 800 600 600 400 400
J	30°-60°	Synthetics Sentetikler	Wash at 30°-60°C 3 rinses Short spin	Anti-crease Kırıcıık önleyici (Suda bekletme) 1000 800 600 600 400 400
K	30°-40°	Delicates Hassas çamaçırılar	Wash at 30°-40°C 3 rinses Short spin	Anti-crease Kırıcıık önleyici (Suda bekletme) 1000 800 600 600 400 400
L	30°-40°	Wool  Yünlüler	Wash at 30°-40°C 3 rinses Short spin	Anti-crease Kırıcıık önleyici (Suda bekletme) 1000 800 600 600 400 400
M		Rinses Durulama	3 rinses with additive Short spin	Anti-crease Kırıcıık önleyici (Suda bekletme) 1000 800 600 600 400 400
N		Rinse with softener Kolalama yumuçatıcı	1 Rinse with additive Short spin	Anti-crease Kırıcıık önleyici (Suda bekletme) 1000 800 600 600 400 400
P		Short spin Kısa sıkma	Empty and short spin	1000 800 600 400 600 400
Q		Drain Boçaltma		

The temperatures indicated are the most suitable for each programme and depend on the type of laundry and the degree of soil.



## Consumption data and duration of main programmes

The values shown in the chart have been obtained in laboratory tests and have been estimated at a water supply temperature of 15°C. They may vary when the appliance is used at home, but they can be used as indicative values.

Programme/ Temperature	Maximum quantity	Water litres	Energy kWh	Duration minutes
Whites at 95°C Beyazlar	5 kg	64	2.2	130
Fast coloureds at 60°C Renkliler hızlı yıkama	5 kg	64	1.30	130
No fast coloureds at 40°C Hassas renkliler	5 kg	64	0.8	110
Synthetics at 60°C Sentetikler	2 kg	52	0.7	75
Delicates at 40°C Hassas çamaşırlar	2 kg	52	0.5	55
Wool at 40°C Yünlüler	1 kg	52	0.5	50

## Cleaning and maintenance

### After each wash

-  At the end of the wash programme, pull the dispenser drawer out a little to let it dry.
-  Leave the door ajar to allow air to circulate.

### If the machine is not used for a prolonged period:

-  Close the water tap and unplug the appliance.

### Periodical cleaning

#### Bodywork

Clean the outside of the machine with warm water and a neutral, non-abrasive household detergent. Rinse with clean water and dry with a soft cloth.

**Important:** do not use methylated spirits, solvents or similar products to clean the bodywork.

#### Detergent dispenser drawer

After a while, detergents and fabric softeners leave deposits in the drawer.

Clean the drawer, from time to time, by rinsing it under a running tap. To remove the drawer from the machine, press the button in the rear left-hand corner.

To facilitate cleaning, the top part of the additive compartment can be removed.

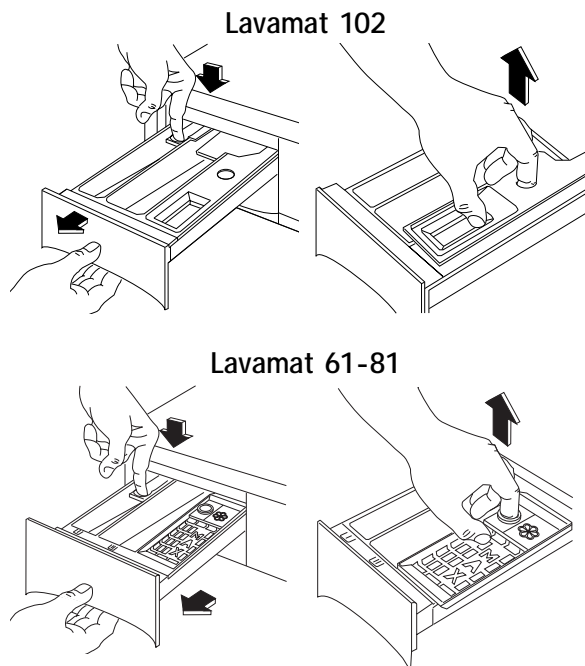

## Cleaning and maintenance

Detergent can also accumulate inside the drawer recess: clean it with an old tooth-brush. Refit the drawer after cleaning.

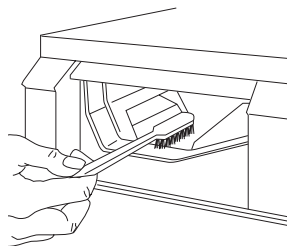

### Drain filter

The drain filter collects threads and small objects inadvertently left in the laundry. Check regularly that the filter is clean.

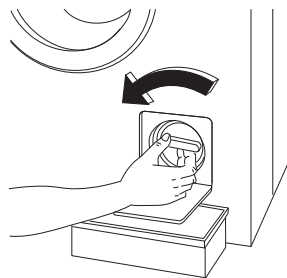
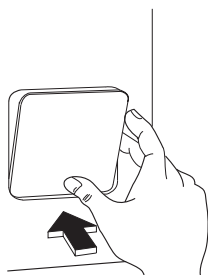

Open the filter door.

Place a container under the filter and unscrew it; some water will come out of the filter.

Pull out the filter.

Clean the filter under a running tap, then refit it, screwing it fully in.

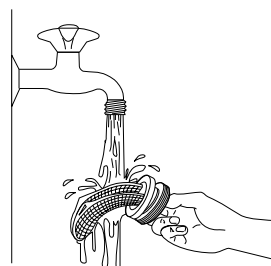
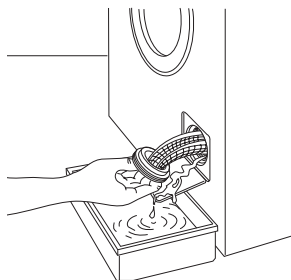

### Water inlet filter

If you notice that the machine is taking longer to fill, check that the filter in the water inlet hose is not blocked.

Turn off the water tap.

Unscrew the hose from the tap and remove the filter.

Clean it with a stiff brush.

Refit the filter and screw the hose back onto the tap.

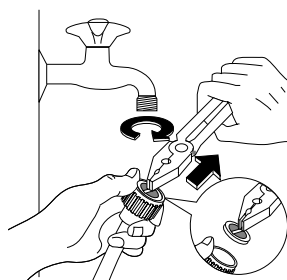



## Emergency emptying out

If the water is not discharged (pump is blocked, filter or drain hose are clogged), proceed as follows to empty out the machine:

- pull out the plug from the power socket;
- close the water tap;
- if necessary, wait until the water has cooled;
- place a bowl on the floor;
- put the drain hose end into the bowl and let the water come out.

Should it not be possible to have access to the drain hose because, for example the appliance is built in the kitchen furniture, slightly loosen the drain filter after placing a bowl on the floor to let the water come out slowly.

At the end screw the filter again.

## Frost precautions

If the machine is installed in a place where the temperature could drop below 0°C, proceed as follows:

- Close the water tap and unscrew the water inlet hose from the tap.
- Place the end of the drain hose and that of the inlet hose in a bowl placed on the floor.
- Select the draining programme and run it until the machine stops.
- Remove the plug from the socket.
- Screw the water inlet hose back on and put the drain hose back in its place.

By doing this, any water remaining in the machine is removed, avoiding the formation of ice and, consequently, breakage of the affected parts.

When you use the machine again, make sure that the ambient temperature is above 0°C.

## Something not working?

- i** If, during the spin cycle, the machine makes an unusual whistling noise, different from the noise made by traditional washing machines, this is due to a new type of motor.

If water is not visible in the drum, this is due to the modern technology of new washing machines that use less water than traditional machines.

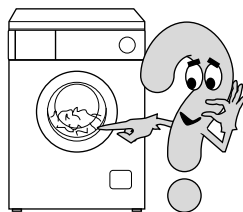

### Troubleshooting

If a problem arises, you can try to solve it yourself following the instructions below. If you call out an engineer when one of the following problems arises, or to repair a fault due to incorrect use, the call-out will be charged even if requested within the guarantee period.

Problem	Possible cause	Solution
The machine does not work	The plug is not connected.	Insert the plug.
	The main electrical fuse has blown.	Replace the fuse.
	The door is not properly closed.	Close the door; the click of the lock should be heard.
	The ON/OFF button has not been pressed.	Press the button.
	The programme selector dial has not been set correctly.	Set the selector dial to the chosen programme.
The machine does not fill	The water tap is closed.	Open the water tap.
	The water inlet hose is squashed or kinked.	Check the whole length of the hose and remove the kink.
	The small filter of the water inlet hose is clogged.	Clean the filter.
	The door is not properly closed.	Close the door.
The machine fills then empties immediately	The end of the drain hose is too low.	Place the hose at the right height (see Installation section).

## Something not working?

Problem	Possible cause	Solution
The machine does not empty and/or does not spin	The drain hose is squashed or kinked.	Check the whole length of the hose and remove the kink.
	The drain filter or the drain hose are clogged.	Clean the filter or check the hose.
	The "antcrease" KIRIÇIK ONLEYİCİ (SUDA BEKLETME) option has been selected.	Empty out the water by pressing the button again or selecting the drain programme (Boçaltma).
	The laundry is not evenly distributed inside the drum.	Redistribute the laundry manually in the drum.
There is water on the floor	Too much detergent has been used.	Measure detergent according to the manufacturer's instructions.
	An unsuitable detergent has been used that creates too much foam.	Use a suitable washing machine detergent.
	One of the connectors on the water inlet hose is leaking.	Check that the hose is firmly screwed on at both ends.
	The drain filter has not been properly screwed on after cleaning.	Fully screw the filter into place.
The machine vibrates or is noisy	The transit bolts have not been removed.	Check that the machine has been unpacked as described in the Installation section.
	The feet have not been adjusted.	Carefully level the machine.
	There is little laundry in the drum.	Correct operation of the machine is not affected.
	The machine is in contact with the wall or furniture.	Move the machine slightly away from the wall or furniture.

## Something not working?

Problem	Possible cause	Solution
The door will not open	The programme is still running.	Wait until the end of the programme before opening the door.
	The door lock has not yet released.	Wait about 2 minutes for the door lock to release.
	The "antcrease" KIRIÇIK ÖNLEYİCİ (SUDA BEKLETME) option has been selected.	Empty out water in order to be able to open the door.
Spinning starts late or the machine does not spin	The unbalance detection device that prevents excessive vibration during spinning and ensures a stable position has cut in.	<p>If the laundry is not evenly distributed inside the drum at the beginning of the spin cycle, the machine detects this and tries to redistribute it more evenly by means of a few drum rotations.</p> <p>Only when the laundry is more evenly distributed, the spin cycle will be performed.</p> <p>If, after about 6 minutes, the laundry is still tangled, the machine will not spin. Therefore, if the laundry is still wet at the end of the cycle, it is advisable to redistribute it manually inside the drum and to select the spin programme again.</p>

Something not working?

## Unsatisfactory washing results

### If the laundry looks grey and lime scale is found in the drum

- Too little detergent has been used.
- An unsuitable detergent has been used.
- Stubborn stains have not been treated prior to washing.
- The programme or the temperature have not been correctly selected.

### If grey stains remain on the laundry

- Laundry stained with ointments, grease or oil has been washed with an insufficient amount of detergent.
- The temperature selected for the wash programme was too low.
- Fabric softener - especially the concentrated type - has come into direct contact with the laundry. Wash these stains immediately and pour fabric softener carefully.

### Foam is still visible even after the last rinse

- Modern detergents often produce foam, even in the last rinse. However the laundry has been completely rinsed.

### White residue is left on the laundry

- This is due to insoluble components in modern detergents and is therefore not the result of insufficient rinsing. Shake or brush the laundry. In future, it may be better to turn garments inside out before washing them. Check the choice of detergent; try using liquid detergents.

## Technical data

Height x Width x Depth	85x60x54 cm
Depth with door opened	91 cm
Height adjustment	± 13 mm approx.
Net weight	74 kg approx.
Load (depending on programme)	5 kg max.
Use	domestic
Drum speed during washing	max. 55 rpm
Drum speed during spinning	1000/800/600 rpm max.
Water pressure	1 - 10 bar (=10-100N/cm <sup>2</sup> = 0.1-1.0Mpa)

- CE** This appliance complies with the following EC directives:
- 73/23/EEC of 19.2.1973 "Low voltage directive", including directive 93 / 68 / EEC
  - 89/336/EEC of 3.5.1989 "Electromagnetic Compatibility Directive".

## Service

In the section "Something not working?" some problems that can be solved by yourself are listed. Read this section in the event of problems. If you are not able to find a solution, contact the Service centre. (Addresses and telephone numbers are given on the enclosed leaflet).

In all cases, set your speech before calling, in order to facilitate troubleshooting: the engineer will be able to decide whether a service call is necessary.

Take note of the serial number (F-Nr.) and the product number (Prod. No.) indicated on the rating plate.

F-Nr. ....

Prod. No. ....

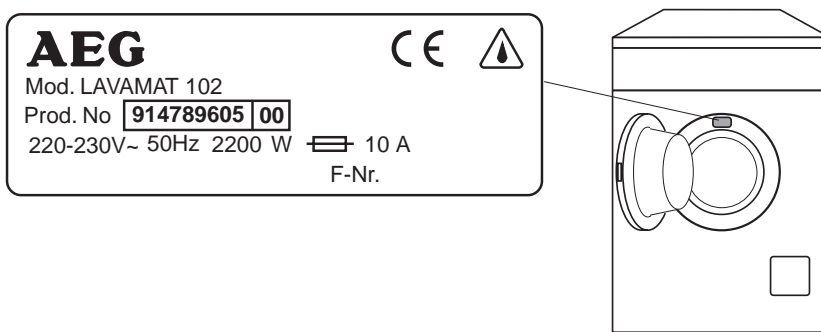

Furthermore, try to specify, as precisely as possible:

- The symptoms of the fault
- When the fault occurs

### When can a service visit be charged during the guarantee period?

- when it should have been possible to solve the problem by yourself, with the help of the troubleshooting chart (see section "Something not working?")
- when the engineer has to come out several times because he has not been given all the relevant information he needs and so, for example, has to fetch spare parts. Repeated trips can be avoided if you prepare your call to the Service centre as described above.

## Instructions for installation and electrical connection



### Safety instructions

- When unpacking the appliance, check that it is not damaged. If in doubt, do not use it and contact the retailer.
- All internal packing must be removed before using the appliance. Serious damage may be caused to the machine or adjacent furniture if the protective transit devices are not removed or are not completely removed. Refer to the relevant paragraph.
- Any electrical work required to install this appliance must be carried out by a qualified electrician.
- Any plumbing work required to install this appliance must be carried out by a qualified plumber.
- After having installed the machine, check that it is not standing on its electrical supply cable.
- If the appliance is placed on a carpeted floor, ensure that air can circulate freely between the adjustable feet and the floor.
- The power supply cable must be replaced only by our Service Centre.



# Dimensions of the appliance

## Front view and side view

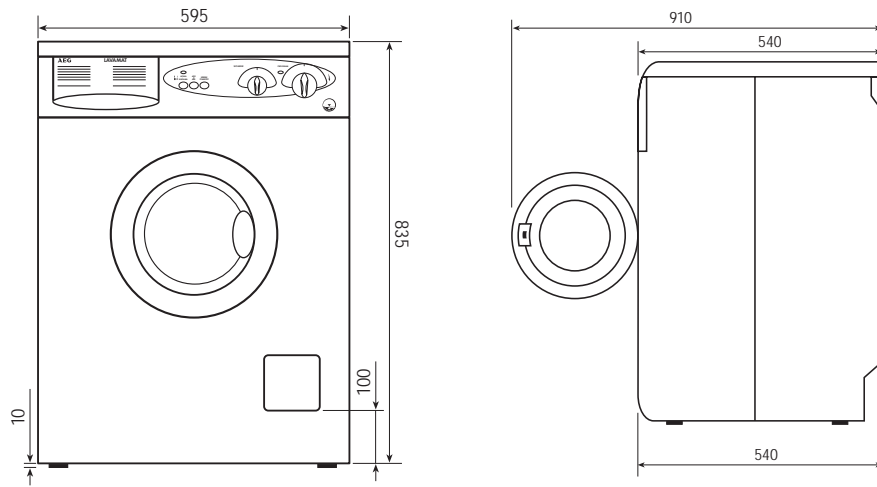

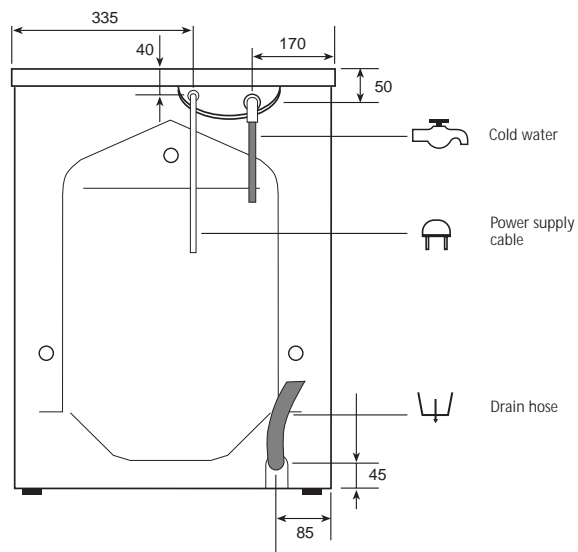

## Rear view





## Installation

### Unpacking

 All transit bolts and packing must be removed before using the appliance.

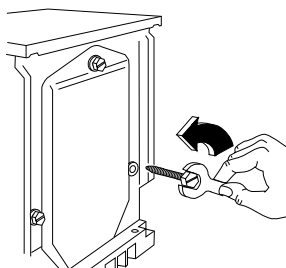
 Using a spanner, unscrew and remove the rear right-hand bolt and lay the machine on its back, taking care not to squash the hoses. This can be avoided by placing one of the corner packing pieces between the machine and the floor.



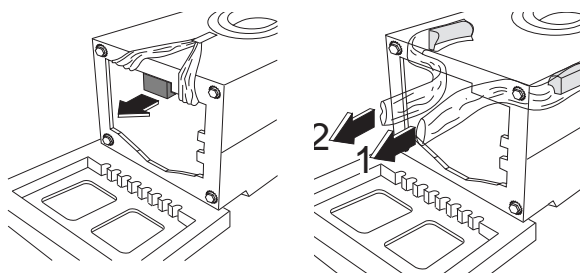

 Remove the polystyrene block from the bottom of the machine and release the two plastic bags by removing the adhesive strip.

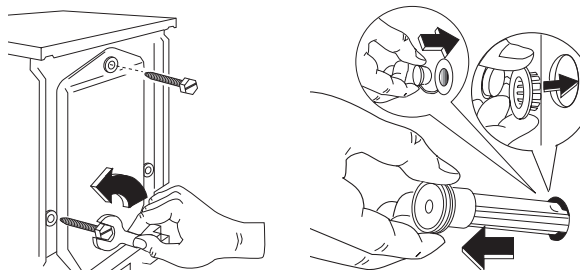

 Carefully remove the right-hand bag (1) then the left-hand bag (2) by pulling them towards the centre of the machine.

 Set the machine upright and remove the two remaining bolts from the back.



 Pull out the three plastic spacers from the holes into which the bolts were fitted.

 Plug the open holes with the plugs which you will find at the back of the appliance.

You are advised to keep all transit devices so that they can be refitted if the machine ever has to be transported again.

## Positioning

Install the machine on a flat hard floor.

Make sure that air circulation around the machine is not impeded by carpets, rugs etc. Check that the machine does not touch the wall or other kitchen units.

- The floor surface must be clean and dry, without any wax or polish residue to avoid any possibility of sliding. Do not use viscous substances to move the appliance into place by sliding it across the floor.
- It is inadvisable to place the machine on long-haired rugs or carpet or on layers of foam-rubber as this would affect its stability.
- Before placing it on small tiles, apply a rubber coating.
- If the appliance is positioned on flexible floors, especially wooden beams with flexible floorboards, use a 15 mm thick, water resistant panel of wood, screwed to at least two of the floor beams. If possible, position the machine in a corner of the room, where the beams are more solidly fixed and tend to be more stable.
- Never try to correct any unevenness in the floor by putting pieces of wood, cardboard or similar materials under the machine.
- If it is impossible to avoid positioning the machine next to a gas cooker or coal-burning stove, an insulating panel (85x57 cm) covered with aluminium foil on the side facing the cooker or stove, must be inserted between the two appliances;
- The machine must not be installed in rooms where the temperature can drop below 0.
- The water inlet hose and the drain hose must not be kinked.

## Levelling

Carefully level by screwing the adjustable feet in or out. Never place cardboard, wood or similar materials under the machine to compensate for any unevenness in the floor.

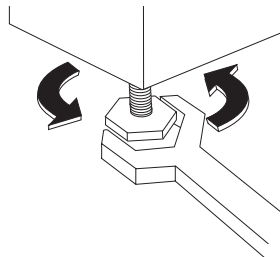

## Installation

**Water inlet**

Connect the water inlet hose to a separate tap with a 3/4" thread after having inserted the small filter "A" supplied with the machine.

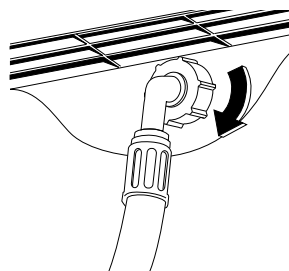
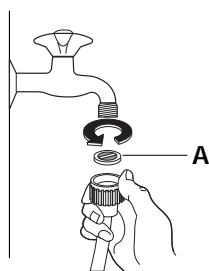

The other end of the inlet hose which connects to the machine can be turned in any direction. Simply loosen the fitting, rotate the hose and retighten the fitting, making sure there are no water leaks.

The inlet hose must not be lengthened. If it is too short and you do not wish to move the tap, you will have to purchase a new, longer hose specially designed for this type of use.

**Water drainage**

The end of the drain hose can be positioned in three ways:

**Hooked over the edge of a sink using the plastic hose guide supplied with the machine.** In this case, make sure the end cannot come unhooked when the machine is emptying.

This could be done by tying it to the tap with a piece of string or attaching it to the wall.

**In a sink drain pipe branch.** This branch must be above the trap so that the bend is at least 60 cm above the ground.

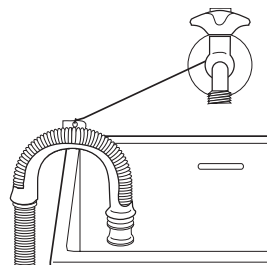

**Directly into a drain pipe at a height** of not less than 60 cm and not more than 90 cm.

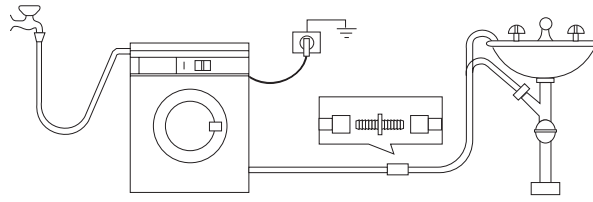

The end of the drain hose must always be **ventilated**, i.e. the inside diameter of the drain pipe must be larger than the outside diameter of the drain hose. The drain hose must not be kinked. Run it along the floor; only the part near the drainage point must be raised.

## Electrical connection

This machine is designed to operate on a 220-230 V, single-phase, 50 Hz supply.

Check that your domestic electrical installation can take the maximum load required (2.2 kW), also taking into account any other appliances in use.

**Connect the machine to an earthed socket.**



The manufacturer declines any responsibility for damage or injury through failure to comply with the above safety precaution.

## Permanent connection

In the case of a permanent connection it is necessary that you install a double pole switch between the appliance and the electricity supply (mains), with a minimum gap of 3 mm between the switch contacts and of a type suitable for the required load in compliance with the current electrical regulations.

The switch must not break the yellow and green earth cable at any point.

This operation has only to be performed by a qualified electrician.

ELECTROLUX DAYANIKLI TÜKETİM  
MALLARI SAN. VE TIC. A.Ç.  
TARLABAÇI BULVARI NO: 35  
80080 - TAKSİM / İSTANBUL  
TEL: 0212 674 20 10 (5 hat) - 0800 211 61 69  
FAX: 0212 674 20 17

© Copyright by AEG

H124.975.532-02-0398