



Electronic Touch Control Cooktop

Safety Instructions 2-4

Operating Instructions

Cookware Tips10, 11
Dual Surface Element 7
Features of Your Cooktop5
Kitchen Timer9
Locking the Cooktop9
Pan Detection Feature9
Pan Sizing Feature9
Surface Elements 6-9
Warmer Surface Element7

Care and Cleaning

Control Lock Pad 13
Glass Cooktop 13, 14
Packaging Tape 12

Troubleshooting Tips 15, 16

Consumer Support

Consumer Support ... Back Cover
Product Registration 17, 18
Warranty 19

Owner's Manual

JP950
JP980

Write the model and serial numbers here:

Model # _____

Serial # _____

You can find them on a label under the cooktop.



IMPORTANT SAFETY INFORMATION. READ ALL INSTRUCTIONS BEFORE USING.

WARNING!

For your safety, the information in this manual must be followed to minimize the risk of fire or explosion, electric shock, or to prevent property damage, personal injury, or loss of life.

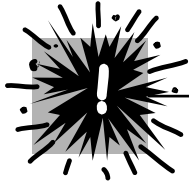

SAFETY PRECAUTIONS

When using electrical appliances, basic safety precautions should be followed, including the following:

- Use this appliance only for its intended use as described in this manual.
- Do not attempt to repair or replace any part of your cooktop unless it is specifically recommended in this manual. All other servicing should be referred to a qualified technician.
- Before performing any service, disconnect the cooktop power supply at the household distribution panel by removing the fuse or switching off the circuit breaker.
- Be sure your appliance is properly installed and grounded by a qualified technician in accordance with the provided installation instructions.
- Have the installer show you the location of the circuit breaker or fuse. Mark it for easy reference.
- Do not leave children alone—children should not be left alone or unattended in an area where an appliance is in use. They should never be allowed to sit or stand on any part of the appliance.
- Teach children not to play with the controls or any other part of the cooktop.
- Do not allow anyone to climb, stand or hang on the cooktop.
- **CAUTION:** Items of interest to children should not be stored in cabinets above a cooktop—children climbing on the cooktop to reach items could be seriously injured.
- Always keep combustible wall coverings, curtains or drapes a safe distance from your cooktop.
- Always keep dish towels, dishcloths, pot holders and other linens a safe distance away from your cooktop.
- Always keep wooden and plastic utensils and canned food a safe distance away from your cooktop. They may become hot and could cause burns.
- Never wear loose-fitting or hanging garments while using the appliance. Flammable material could be ignited if brought in contact with hot surface elements and may cause severe burns.
- Use only dry pot holders—moist or damp pot holders on hot surfaces may result in burns from steam. Do not let pot holders touch hot surface elements. Do not use a towel or other bulky cloth. Such cloths can catch fire on a hot surface element.
- Do not use water on grease fires. Never pick up a flaming pan. Turn the controls off. Smother a flaming pan on a surface element by covering the pan completely with a well-fitting lid, cookie sheet or flat tray. Use a multi-purpose dry chemical or foam-type extinguisher.
- Flaming grease outside a pan can be put out by covering with baking soda or, if available, by using a multi-purpose dry chemical or foam-type fire extinguisher.
- When preparing flaming foods under the hood, turn the fan on.



COOK MEAT AND POULTRY THOROUGHLY...

Cook meat and poultry thoroughly—meat to at least an INTERNAL temperature of 160°F and poultry to at least an INTERNAL temperature of 180°F. Cooking to these temperatures usually protects against foodborne illness.



⚠ WARNING! SAFETY PRECAUTIONS

- Do not touch glass ceramic surface elements while cooking. This surface may be hot enough to burn even though it may appear dark in color. During and after use, do not touch, or let clothing or other flammable materials contact the cooking surface. Note the hot indicator lights and allow sufficient time for cooling first.
- Hot surfaces may include both the cooktop and areas facing the cooktop.
- To minimize the possibility of burns, ignition of flammable materials and spillage, the handle of a container should be turned toward the center of the cooktop without extending over any nearby surface elements.
- Always turn off the surface element control before removing the cookware.
- Use proper pan size—select cookware having flat bottoms large enough to cover the surface element heating element. The use of undersized cookware will expose a portion of the surface element to direct contact and may result in ignition of clothing. Proper relationship of cookware to surface element will also improve efficiency.
- Never leave surface elements unattended at high heat settings. Boilovers may cause smoking and greasy spillovers may ignite.
- Glass and ceramic cookware is not recommended for use with your radiant ceramic glass cooktop.
- Keep an eye on foods being fried at high or medium-high heat settings.
- Foods for frying should be as dry as possible. Frost on frozen foods or moisture on fresh foods can cause hot fat to bubble up and over the sides of the pan.
- Avoid placing any objects on or near the keypads in order to prevent accidental activation of the cooktop controls.
- Use little fat for effective shallow or deep-fat frying. Filling the pan too full of fat can cause spillovers when food is added.
- If a combination of oils or fats will be used in frying, stir together before heating, or as fats melt slowly.
- Always heat fat slowly, and watch as it heats.
- Use a deep-fat thermometer whenever possible to prevent overheating fat beyond the smoking point.
- Never try to move a pan of hot fat, especially a deep-fat fryer. Wait until the fat is cool.
- Do not store flammable materials near the cooktop.
- Keep the hood and grease filters clean to maintain good venting and to avoid grease fires.
- Do not store or use combustible materials, gasoline or other flammable vapors and liquids in the vicinity of this or any appliance.
- Clean only parts listed in this Owner's Manual.
- Do not leave paper products, cooking utensils or food on the cooktop when not in use.
- Keep cooktop clean and free of accumulation of grease or spillovers which may ignite.
- Never heat unopened food containers. Pressure buildup may make container burst and cause injury.
- Never leave jars or cans of fat drippings on or near your cooktop.
- Never use your appliance for warming or heating the room.

IMPORTANT SAFETY INFORMATION. READ ALL INSTRUCTIONS BEFORE USING.

⚠ **WARNING!**



RADIANT SURFACE ELEMENTS

Use care when touching the cooktop. The glass surface of the cooktop will retain heat after the controls have been turned off.

- Avoid scratching the glass cooktop. The cooktop can be scratched with items such as sharp instruments, rings or other jewelry.
- Never use the glass cooktop surface as a cutting board.
- Do not place or store items on top of the glass cooktop surface when it is not in use.
- Be careful when placing spoons or other stirring utensils on glass cooktop surface when it is in use. They may become hot and could cause burns.
- Avoid heating an empty pan. Doing so may damage the cooktop and the pan.
- Do not allow water, other liquids or grease to remain on the cooktop.
- Do not operate the glass surface elements if the glass is broken. Spillovers or cleaning solution may penetrate a broken cooktop and create a risk of electrical shock. Contact a qualified technician immediately should your glass cooktop become broken.
- Spilled or burnt-on foods may cause accidental activation or deactivation of the keypad. Clean the keypad thoroughly, and controls will resume normal operation.
- To prevent accidental activation of the cooktop, do not place any objects on or near the keypad.
- Clean the cooktop with caution. Always lock the control panel using the control lock feature and wait until the entire glass surface is cool before attempting to clean the cooktop. See the *Locking the Cooktop* section for details. If a wet sponge or cloth is used to wipe spills on a hot surface element, be careful to avoid steam burns. Some cleansers can produce noxious fumes if applied to a hot surface.
- When the cooktop is cool, use only CERAMA BRYTE® Ceramic Cooktop Cleaner and the CERAMA BRYTE® Cleaning Pad to clean the cooktop.
- To avoid possible damage to the cooking surface, do not apply the cleaning cream to the glass surface when it is hot.
- After cleaning, use a dry cloth or paper towel to remove all the cleaning cream residue.
- Read and follow all instructions and warnings on the cleaning cream labels.
- Large scratches or impacts to cooktops can lead to broken or shattered glass.
- Use care when touching the cooktop. The glass surface of the cooktop will retain heat after the controls have been turned **OFF**.
- Do not stand on the glass cooktop.

the cooktop. See the *Locking the Cooktop* section for details. If a wet sponge or cloth is used to wipe spills on a hot surface element, be careful to avoid steam burns. Some cleansers can produce noxious fumes if applied to a hot surface.

NOTE: We recommend that you avoid wiping any surface element areas until they have cooled and the indicator light has gone off. **Sugar spills are the exception to this.** Please see the *Cleaning the glass cooktop* section.



READ AND FOLLOW THIS SAFETY INFORMATION CAREFULLY.
SAVE THESE INSTRUCTIONS

Features of your cooktop.

www.GEAppliances.com

Throughout this manual, features and appearance may vary from your model.

Safety Instructions

Operating Instructions

Care and Cleaning

Troubleshooting Tips

Consumer Support

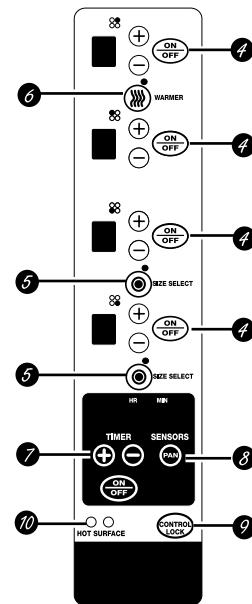
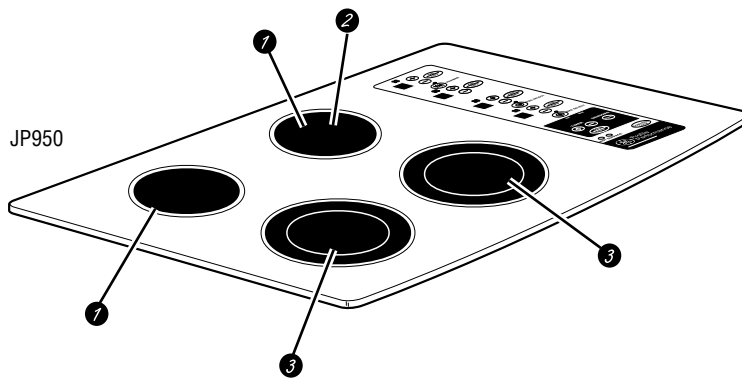
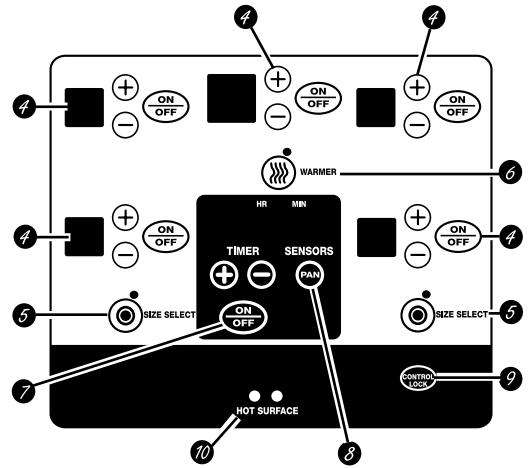
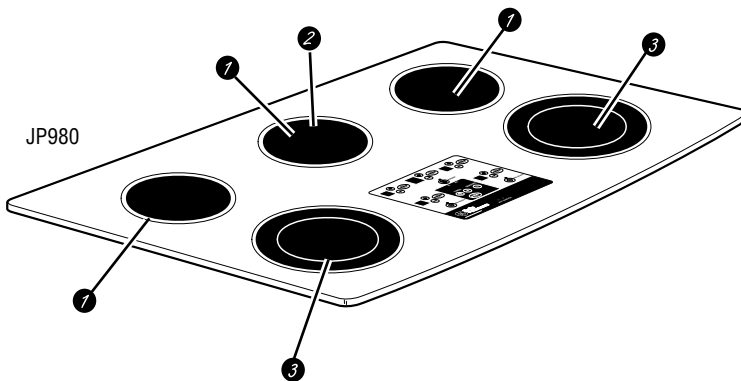

Feature Index (Features and appearances may vary.)	Explained on page
1 Single Surface Element	6
2 Warmer Surface Element	8
3 Dual Surface Element	7
4 Single Surface Element Control Pad	6
5 Dual Surface Element Control Pad	7
6 Warmer Surface Element Control Pad	8
7 Kitchen Timer Control Pad	9
8 Pan Sensor Control Pad	9
9 Control Lock Pad	9
10 Hot Surface Indicator Lights (one for each surface element)	9

Using the surface elements.

Your new Profile Cooktop makes an eloquent statement of style, convenience, and kitchen planning flexibility. Whether you chose it for its purity of design, assiduous attention to detail, or for both of these reasons—you'll find that your Profile cooktop's superior blend of form and function will delight you for years to come.

This cooktop contains several new features such as pan detection and pan sizing. The touch controls give you precise control of the surface elements. You can quickly switch between a steady low heat and full power or any setting in between. The information on the following pages will help you operate and maintain your cooktop properly.

NOTE: Throughout this manual, features and appearance may vary from your model.



Never cook directly on the glass. Always use cookware.



Always center the pan on the surface element you are using.



Do not slide cookware across the control or cooktop surface because it can scratch the glass. The glass is scratch-resistant, not scratchproof.

About the radiant surface elements...

The radiant cooktop features heating elements beneath a smooth glass surface.

Cooktop temperatures increase with the number of surface elements that are on. With 3 or 4 elements turned on, cooktop temperatures are high. Always use caution when touching it.

The indicator lights will come on next to the Warmer and Dual burners when activated. Lights also activate for the Pan Detect and Control Lock features when they are turned on. The indicator lights will go off when the surface element or feature is turned off.

The appropriate **HOT SURFACE** indicator light will glow when its corresponding radiant element is turned on and will remain on until the surface has cooled to approximately 150°F.

NOTE:

Hot surface indicator light will:

- Come on when the surface element is turned on.
- Stay on even after the element is turned off.
- Glow brightly until the element has cooled below 150°F.

NOTE: A slight odor is normal when a new cooktop is used for the first time. It is caused by the heating of new parts and insulating materials and will disappear in a short time.

It is safe to place hot cookware (from the oven or surface) on the glass cooktop when the surface is cool. **Never place cookware on the control area.**

Even after the surface elements are turned off, the glass cooktop retains enough heat to continue cooking. To avoid overcooking, remove pans from the surface elements when the food is cooked. Avoid placing utensils that could become hot or plastics that could melt on the surface element until it has cooled completely.

- Water stains (mineral deposits) are removable using the cleaning cream or full strength white vinegar.
- Use of window cleaner may leave an iridescent film on the cooktop. The cleaning cream will remove this discoloration.
- Don't store heavy items above the cooktop. If they drop onto the cooktop, they can cause damage.
- Do not use the surface as a cutting board.

Radiant Surface Elements

The controls for the radiant surface elements allow for 11 different heat settings: Low, 1–9 and High. The heating element may not visibly glow at low heat settings.

The surface heating element will cycle on and off to maintain your selected control setting.

Each radiant surface element has a temperature limiter which protects the glass cooktop from getting too hot.

NOTE: This cooktop has a rapid heat-up feature.

- If the cooktop is cool when turned on, it will glow red for a short period of time until the desired power setting is reached.
- If the cooktop is already warm, the rapid heat-up feature may not activate.

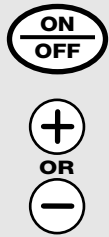

Single Surface Element

To turn on a single surface element:

- 1 Touch the **ON/OFF** pad, then touch the **(+)**/**(-)** pad.
- 2 Use the **(+)**/**(-)** pad to choose the desired power setting. The control will beep each time a pad is touched.

To turn off a single surface element, touch the **ON/OFF** pad again.

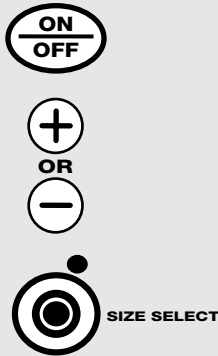

Dual Surface Element

The dual surface element has a pan sizing sensor which will automatically set the small or large surface element to match the size of your pan (see the *Using Pan Sizing* section). To override the automatic pan sizing sensor and select the small or large surface element:

- 1 Touch the dual surface element **ON/OFF** pad.
- 2 Use the **(+)**/**(-)** pad to set the desired power setting.

- 3 Touch the **SIZE SELECT** pad once to turn on the large surface element. Touch the pad again to turn on the small surface element.

When the indicator light next to the **SIZE SELECT** pad is on, the large surface element is on. When it is off, the small surface element is on.

To turn the dual surface element off, touch the **ON/OFF** pad.



Warmer Surface Element

To turn on the warmer surface element:

- 1 Touch the **ON/OFF** pad, then touch the **WARMER** pad. The surface element will turn on to warmer power setting W1 (low).
- 2 Use the **(+)**/**(-)** pad to choose additional settings of W2 (medium) and W3 (high).

To turn off the warmer power settings, touch the **ON/OFF** pad. To change from the warmer settings to regular cooking settings, press the **WARMER** pad. The surface element will be on power setting L (low). The surface element may then be set to the desired setting using the **(+)**/**(-)** pads. To turn off the surface element, touch the **ON/OFF** pad again.

CAUTION: Do not warm food on the **WARMER** for more than two hours.

Do not use plastic wrap to cover food. Plastic may melt onto the surface and be very difficult to remove.

Use only cookware recommended for top-of-range cooking.

The **WARMER** will keep hot, cooked food at serving temperature. Always start with hot food. Do not use to heat cold food. **Placing uncooked or cold food on surface warmer could result in foodborne illness.**

For best results, all food on the **WARMER** should be covered with a lid or aluminum foil. When warming pastries or breads, the cover should be vented to allow moisture to escape.

Always use potholders or oven mitts when removing food from the **WARMER** as cookware and plates will be hot.

A hot surface indicator light will glow when the glass surface is hot and will remain on until the surface has cooled below 150°F.

Food Type	Control Setting
Breads/Pastries	W1 (LOW)
Sauces	W2 (Medium)
Soups (cream)	W2 (Medium)
Stews	W2 (Medium)
Vegetables	W2 (Medium)
Hot Beverages	W3 (HIGH)
Soups (liquid)	W3 (HIGH)

The chart above shows initial suggested settings only. The temperature, type and amount of food, and the time held will affect the quality of the food.

Using the surface elements.

Fault Code (“F” and a number in the display)

If an error occurs in the control operation, a fault code will flash “F” with a number in the display and the control will produce an audible sound.

To correct:

- 1 Touch the **CONTROL LOCK** pad to reset the control.
- 2 Attempt to set the control to the desired cooking setting.
- 3 If the fault code is not cleared, allow the cooktop to cool completely.
- 4 After cooling, touch the **CONTROL LOCK** pad again to reset the control. Again attempt to set the control to the desired cooking setting.
- 5 If the fault code is still not cleared, turn off the cooktop power at the circuit breaker or fuse box for one minute.
- 6 If the fault code reappears, call for service.



How to Lock the Cooktop

IMPORTANT: As a convenience, you can lock the entire cooktop at any time when it is not in use or before cleaning. Locking the cooktop will prevent surface elements from being turned on accidentally.

To lock the cooktop:

Touch and hold the **CONTROL LOCK** pad for 3 seconds.

A two-beep signal will sound, the word “LOCK” will appear in the **TIMER** display,

and the Control Lock light will turn on, indicating that the cooktop is locked. If the cooktop is locked while the surface elements or timer are in use, they will automatically turn off.

To unlock:

Touch and hold the **CONTROL LOCK** pad again for 3 seconds.

A two-beep signal will sound, and the Control Lock light will go out, indicating that the cooktop is unlocked.

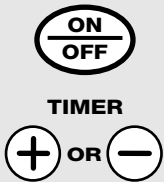

How to Operate the Kitchen Timer

NOTE: The kitchen timer will **NOT** turn off the surface elements when the time reaches 00:00.

To operate the kitchen timer, use the pads below the **TIMER** display.

Touch the **ON/OFF** pad and then touch the **(+)**/**(-)** pad to choose the desired time setting. If the **(+)**/**(-)** pad is held for several seconds, the timer will increase or decrease at a faster rate.

After you have chosen your desired time, the timer will automatically start to count down from the hours/minutes that you have selected. After the timer counts down to the last minute, it will count down in seconds until 00:00. After the time has run out, the control will beep twice every five seconds until the timer is turned off. Touch the **ON/OFF** pad to turn the timer off.



Using the Pan Detection Feature

This feature automatically turns off a surface element after 60 seconds if a pan is absent from the surface element. The power level display will flash until the surface element automatically turns off when the control detects the absence of a pan.

To activate and deactivate pan detection for all surface elements:

Touch the **PAN** pad. (At least one surface element must be on.) The display will flash “PAN ON” when the pan detection feature is on.

A signal will sound and a light next to the **PAN** pad will indicate whether the feature is active. If the light is on, pan

detection is on, and if the light is off, pan detection is off. When the pan detection feature is disabled, the pan sizing feature is also disabled.

NOTES:

- For this feature to work properly, the pan diameter must be greater than 4.0 inches and centered on the surface element.
- This feature may not operate properly with rounded, curved or warped pan bottoms (see the *Types of Cookware* section).
- This feature will not work with glass-ceramic/stoneware cookware (see the *Types of Cookware* section).



Using Pan Sizing

This feature is only used on the dual surface element when the pan detection feature is enabled. When a small pan is placed on the surface element, the small surface element will activate. When a pan larger than 6.0 inches is placed on the surface element, the large surface element will automatically activate. This feature may be overridden for a single cooking session while leaving the pan detection feature active (see *Dual Surface Element* section).

To turn off this feature and the pan detection feature:

Touch the **PAN** pad.

The light next to the pad will go out, indicating that pan features are turned off.

NOTE: The pan must be centered over the surface element for this feature to work properly.

Selecting types of cookware.

The following information will help you choose cookware which will give good performance on glass cooktops.

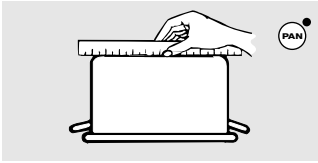

Check pans for flat bottoms by using a straight edge.

 Pan Detection/Sizing will work properly with these types of cookware.

 Pan Detection/Sizing will not work with these types of pans.

Stainless Steel:  recommended

Aluminum:  heavyweight recommended

Good conductivity. Aluminum residue sometimes appears as scratches on the cooktop but can be removed if cleaned immediately. Because of its low melting point, thin weight aluminum should not be used.

Copper: recommended

Copper Bottoms:  usable, but not recommended

Pans with copper bottoms may leave residue appearing as scratches. Remove any residue immediately after use. Do not let a pot boil dry. Overheated metal can bond to the glass cooktop and leave a permanent stain if it is not removed immediately.

Porcelain Enamel-Covered Cast Iron:  recommended

As long as the cookware is covered completely with porcelain enamel, this cookware is recommended. Caution is recommended for cast-iron cookware that is not completely covered with smooth porcelain enamel, since it may scratch the glass ceramic cooktop.

Glass-Ceramic/Stoneware:  not recommended

Poor performance. May scratch the surface.

NOTE: Use pans that match the diameter of the surface element. Cooking performance will not be as good if the cookware is either smaller or larger than the surface element.

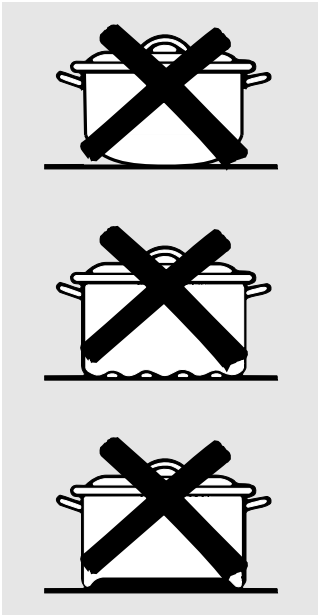

Pans with rounded, curved, ridged or warped bottoms are not recommended. Pan Detection/Sizing may not work properly with these types of pans.



Do not place wet pans on the glass cooktop.

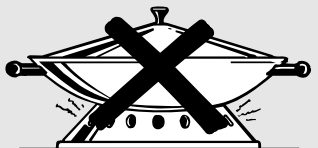

Do not use woks with support rings on the glass cooktop.



Use flat-bottomed woks on the glass cooktop.

For Best Results

- Place only dry pans on the surface elements. Do not place lids on the surface elements, particularly wet lids.
- Do not use woks that have support rings. This type of wok will not heat on glass surface elements.
- Use only a flat-bottomed wok, available from many popular cookware manufacturers. The bottom of the wok should have the same diameter as the surface element to insure proper contact.
- Some special cooking procedures require specific cookware such as pressure cookers, deep-fat fryers, etc. All cookware must have flat bottoms that match the size of the surface elements.

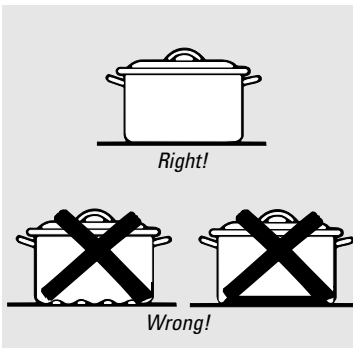

Note: Flat-bottomed canners are required for glass cooktops.

Observe the Following Points in Canning

When canning with water-bath or pressure canner, larger-diameter pots may be used. This is because boiling water temperatures (even under pressure) are not harmful to the cooktop surfaces surrounding the surface elements.

HOWEVER, DO NOT USE LARGE-DIAMETER CANNERS OR OTHER LARGE-DIAMETER POTS FOR FRYING OR BOILING FOODS OTHER THAN WATER. Most syrup or sauce mixtures—and all types of frying—cook at temperatures much higher than boiling water. Such temperatures could eventually harm the glass cooktop surfaces.

- 1 Be sure the canner fits over the center of the surface element. If your cooktop or its location does not allow the canner to be centered on the surface element, use smaller-diameter pots for good canning results.
- 2 Flat-bottomed canners must be used. Do not use canners with flanged or rippled bottoms (often found in enamelware) because they don't make enough contact with the surface elements and take a long time to boil water.
- 3 When canning, use recipes and procedures from reputable sources. Reliable recipes and procedures are available from the manufacturer of your canner; manufacturers of glass jars for canning, such as Ball and Kerr brand; and the United States Department of Agriculture Extension Service.
- 4 Remember that canning is a process that generates large amounts of steam. To avoid burns from steam or heat, be careful when canning.

NOTE: If your house has low voltage, canning may take longer than expected, even though directions have been carefully followed. The process time will be shortened by:

- (1) using a pressure canner, and
- (2) starting with **HOT** tap water for fastest heating of large quantities of water.

CAUTION:

- Safe canning requires that harmful microorganisms are destroyed and that the jars are sealed completely. When canning foods in a water-bath canner, a gentle but steady boil must be maintained for the required time. When canning foods in a pressure canner, the pressure must be maintained for the required time.
- After you have adjusted the controls, it is very important to make sure the prescribed boil or pressure levels are maintained for the required time.
- Since you must make sure to process the canning jars for the prescribed time, with no interruption in processing time, do not can on any cooktop surface element if your canner is not flat.

Safety Instructions
Operating Instructions
Care and Cleaning
Troubleshooting Tips
Consumer Support

Care and cleaning of the cooktop.

Be sure electrical power is off and all surfaces are cool before cleaning any part of the cooktop.

How to Remove Protective Shipping Film and Packaging Tape

Carefully grasp a corner of the protective shipping film with your fingers and slowly peel it from the appliance surface. Do not use any sharp items to remove the film. Remove all of the film before using the appliance for the first time.

NOTE: The adhesive must be removed from all parts before using the cooktop. It cannot be removed if it is baked on.

To assure no damage is done to the finish of the product, the safest way to remove the adhesive from packaging tape on new appliances is an application of a household liquid dishwashing detergent. Apply with a soft cloth and allow to soak.



Control Lock Pad

As a convenience, you can lock the entire cooktop at any time when it is not in use or before cleaning.

Locking the cooktop will prevent surface elements from being turned on accidentally.

Begin by locking the cooktop; see the *Locking the Cooktop* section. Use the same cleaning methods as those described for the glass-ceramic top.



Clean your cooktop after each spill. Use CERAMA BRYTE® Ceramic Cooktop Cleaner.

Normal Daily Use Cleaning

ONLY use CERAMA BRYTE® Ceramic Cooktop Cleaner on the glass cooktop. Other creams may not be as effective.

To maintain and protect the surface of your glass cooktop, follow these steps:

- 1 Before using the cooktop for the first time, clean it with CERAMA BRYTE® Ceramic Cooktop Cleaner. This helps protect the top and makes cleanup easier.
- 2 Daily use of CERAMA BRYTE® Ceramic Cooktop Cleaner will help keep the cooktop looking new.

- 3 Shake the cleaning cream well. Apply a few drops of CERAMA BRYTE® Ceramic Cooktop Cleaner directly to the cooktop.
- 4 Use a paper towel or CERAMA BRYTE® Cleaning Pad for Ceramic Cooktops to clean the entire cooktop surface.
- 5 Use a dry cloth or paper towel to remove all cleaning residue. No need to rinse.

NOTE: It is very important that you *DO NOT* heat the cooktop until it has been cleaned thoroughly.

Burned-On Residue

WARNING: DAMAGE to your glass surface may occur if you use scrub pads other than the pad included with your cooktop.

- 1 Allow the cooktop to cool.
- 2 Spread a few drops of CERAMA BRYTE® Ceramic Cooktop Cleaner on the entire burned residue area.
- 3 Using the included CERAMA BRYTE® Cleaning Pad for Ceramic Cooktops, rub the residue area, applying pressure as needed.

- 4 If any residue remains, repeat the steps listed above as needed.
- 5 For additional protection, after all residue has been removed, polish the entire surface with CERAMA BRYTE® Ceramic Cooktop Cleaner and a paper towel.

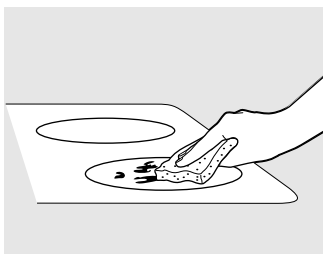

Use a CERAMA BRYTE® Cleaning Pad for Ceramic Cooktops.

Heavy, Burned-On Residue

- 1 Allow the cooktop to cool.
- 2 Use a single-edge razor blade scraper at approximately a 45° angle against the glass surface and scrape the soil. It will be necessary to apply pressure to the razor scraper in order to remove the residue.
- 3 After scraping with the razor scraper, spread a few drops of CERAMA BRYTE® Ceramic Cooktop Cleaner on the entire

burned residue area. Use the CERAMA BRYTE® Cleaning Pad to remove any remaining residue.

- 4 For additional protection, after all residue has been removed, polish the entire surface with CERAMA BRYTE® Ceramic Cooktop Cleaner and a paper towel.

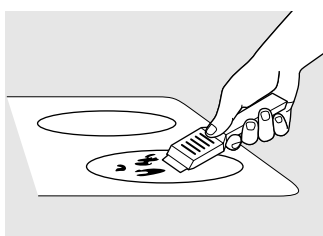

The CERAMA BRYTE® Ceramic Cooktop Scraper and all recommended supplies are available through our Parts Center. See instructions under "To Order Parts" section on next page.

NOTE: Do not use a dull or nicked blade.

Cleaning the glass cooktop.

Metal Marks and Scratches

- 1 Be careful not to slide pots and pans across your cooktop. It will leave metal markings on the cooktop surface.
- These marks are removable using the CERAMA BRYTE® Ceramic Cooktop Cleaner with the CERAMA BRYTE® Cleaning Pad for Ceramic Cooktops.

- 2 If pots with a thin overlay of aluminum or copper are allowed to boil dry, the overlay may leave black discoloration on the cooktop.
- This should be removed immediately before heating again or the discoloration may be permanent.

WARNING: Carefully check the bottom of pans for roughness that would scratch the cooktop.

Glass surface—potential for permanent damage.

Our testing shows that if you are cooking high sugar mixtures such as jelly or fudge and have a spillover, it can cause permanent damage to the glass surface unless the spillover is immediately removed.

Damage from Sugary Spills and Melted Plastic

- 1 Turn off all surface elements. Remove hot pans.
- 2 Wearing an oven mitt:
- Use a single-edge razor blade scraper (CERAMA BRYTE® Ceramic Cooktop Scraper) to move the spill to a cool area on the cooktop.
 - Remove the spill with paper towels.

- 3 Any remaining spillover should be left until the surface of the cooktop has cooled.
- 4 Don't use the surface elements again until all of the residue has been completely removed.

NOTE: If pitting or indentation in the glass surface has already occurred, the cooktop glass will have to be replaced. In this case, service will be necessary.

To Order Parts

To order CERAMA BRYTE® Ceramic Cooktop Cleaner and the cooktop scraper, please call our toll-free number:

National Parts Center 800.626.2002.

CERAMA BRYTE® Ceramic Cooktop Cleaner # WX10X300

CERAMA BRYTE® Ceramic Cooktop Scraper # WX10X0302

Kit # WB64X5027
(Kit includes cream and cooktop scraper)

CERAMA BRYTE® Cleaning Pads for Ceramic Cooktops # WX10X350

Before you call for service...



Troubleshooting Tips
Save time and money! Review the charts on the following pages first and you may not need to call for service.

Problem	Possible Causes	What To Do
Surface elements will not maintain a rolling boil or cooking is slow	Improper cookware being used.	<ul style="list-style-type: none"> Use pans which are absolutely flat and match the diameter of the surface element selected.
Surface elements do not work properly	Cooktop controls improperly set.	<ul style="list-style-type: none"> Check to see the correct control is set for the surface element you are using.
Scratches on cooktop glass surface	Incorrect cleaning methods being used.	<ul style="list-style-type: none"> Use recommended cleaning procedures. See the <i>Cleaning the glass cooktop</i> section.
	Cookware with rough bottoms being used or coarse particles (salt or sand) were between the cookware and the surface of the cooktop. Cookware has been slid across the cooktop surface.	<ul style="list-style-type: none"> To avoid scratches, use the recommended cleaning procedures. Make sure bottoms of cookware are clean before use, and use cookware with smooth bottoms.
Areas of discoloration on the cooktop	Food spillovers not cleaned before next use.	<ul style="list-style-type: none"> See the <i>Cleaning the glass cooktop</i> section.
	Hot surface on a model with a light-colored glass cooktop.	<ul style="list-style-type: none"> This is normal. The surface may appear discolored when it is hot. This is temporary and will disappear as the glass cools.
Plastic melted to the surface	Hot cooktop came into contact with plastic placed on the hot cooktop.	<ul style="list-style-type: none"> See the <i>Glass surface – potential for permanent damage</i> section in the <i>Cleaning the glass cooktop</i> section.
Pitting (or indentation) of the cooktop	Hot sugar mixture spilled on the cooktop.	<ul style="list-style-type: none"> Call a qualified technician for replacement.
Frequent cycling off and on of surface elements	Improper cookware being used.	<ul style="list-style-type: none"> Use only flat cookware to minimize cycling. See the <i>Radiant surface elements</i> section.
Unresponsive keypad	Keypad is dirty.	<ul style="list-style-type: none"> Clean the keypad.
	A fuse in your home may be blown or the circuit breaker tripped.	<ul style="list-style-type: none"> Replace the fuse or reset the circuit breaker.
Pan detection/sizing not working properly	Improper cookware being used.	<ul style="list-style-type: none"> Use a flat, metallic pan that is 4.0" or larger.
	Pan is improperly placed.	<ul style="list-style-type: none"> Make sure the pan is centered on the corresponding surface element.
	Cooktop control improperly set.	<ul style="list-style-type: none"> Check to see that the control is set properly.

Before you call for service...



Troubleshooting Tips

Save time and money! Review the charts on the following pages first and you may not need to call for service.

Problem	Possible Causes	What To Do
TEMP appears in the display	Cooktop too hot and the time-out feature activated.	<ul style="list-style-type: none"> • Allow the surface element(s) to cool for 1/2 to 1 hour before using again.
Surface element is glowing red when it should be on a low power setting	The rapid heat-up feature activated.	<ul style="list-style-type: none"> • The cooktop has a rapid heat-up feature and is designed to do this. See the <i>Radiant surface elements</i> section.
"F" and a number appear in the display and the cooktop produces an audible sound	You have a fault code.	<ul style="list-style-type: none"> • Write down the "F" and the number and touch the CONTROL LOCK pad. See the <i>Fault code</i> section.

GE Service Protection Plus™

GE, a name recognized worldwide for quality and dependability, offers you Service Protection Plus™—comprehensive protection on all your appliances—**No Matter What Brand!**

Benefits Include:

- Backed by GE
- All brands covered
- Unlimited service calls
- All parts and labor costs included
- No out-of-pocket expenses
- No hidden deductibles
- One 800 number to call

***We'll Cover Any Appliance.
Anywhere. Anytime.****

You will be completely satisfied with our service protection or you may request your money back on the remaining value of your contract. No questions asked. It's that simple.

Protect your refrigerator, dishwasher, washer and dryer, range, TV, VCR and much more—**any brand!** Plus there's no extra charge for emergency service and low monthly financing is available. Even icemaker coverage and food spoilage protection is offered. You can rest easy, knowing that all your valuable household products are protected against expensive repairs.

Place your confidence in GE and call us in the U.S. toll-free at **800.626.2224** for more information.

*All brands covered, up to 20 years old, in the continental U.S.

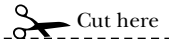

Please place in envelope and mail to:

General Electric Company
Warranty Registration Department
P.O. Box 32150
Louisville, KY 40232-2150

Consumer Product Ownership Registration

Dear Customer:

Thank you for purchasing our product and thank you for placing your confidence in us. We are proud to have you as a customer!

Follow these three steps to protect your new appliance investment:

1 Complete and mail your Consumer Product Ownership Registration today. Have the peace of mind of knowing we can contact you in the unlikely event of a safety modification.

2 After mailing the registration below, store this document in a safe place. It contains information you will need should you require service. Our service number is 800.GE.CARES (800.432.2737).

3 Read your Owner's Manual carefully. It will help you operate your new appliance properly.

Model Number

Serial Number

Important: If you did not get a registration card with your product, detach and return the form below to ensure that your product is registered, or register online at www.GEAppliances.com.

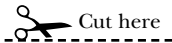

Consumer Product Ownership Registration



Model Number

Serial Number

Mr. Ms. Mrs. Miss

First Name _____

Last Name _____

Street Address _____

Apt. # _____

E-mail Address* _____

City _____

State _____

Zip Code _____

Date Placed In Use
Month _____

Day _____

Year _____

Phone Number _____-_____-_____



GE Appliances

GE Consumer & Industrial
Louisville, Kentucky
www.GEAppliances.com

* Please provide your e-mail address to receive, via e-mail, discounts, special offers and other important communications from GE Appliances (GEA).

Check here if you do not want to receive communications from GEA's carefully selected partners.

FAILURE TO COMPLETE AND RETURN THIS CARD DOES NOT DIMINISH YOUR WARRANTY RIGHTS.

For information about GEA's privacy and data usage policy, go to www.GEAppliances.com and click on "Privacy Policy" or call 800.626.2224.

GE Electric Cooktop Warranty.



All warranty service provided by our Factory Service Centers, or an authorized Customer Care® technician. To schedule service, on-line, 24 hours a day, visit us at www.GEAppliances.com, or call 800.GE.CARES (800.432.2737).

Staple your receipt here. Proof of the original purchase date is needed to obtain service under the warranty.

For The Period Of:	GE Will Replace:
One Year From the date of the original purchase	Any part of the cooktop which fails due to a defect in materials or workmanship. During this full one-year warranty , GE will also provide, free of charge , all labor and in-home service to replace the defective part.
Five Years From the date of the original purchase	A replacement glass cooktop if it should crack due to thermal shock, discolor, or if the pattern wears off. A replacement radiant surface element if it should burn out. During this limited additional four-year warranty , you will be responsible for any labor or in-home service.

What GE Will Not Cover:

- Service trips to your home to teach you how to use the product.
- Improper installation, delivery or maintenance.
- Failure of the product if it is abused, misused, or used for other than the intended purpose or used commercially.
- Damage to the glass cooktop caused by use of cleaners other than the recommended cleaning creams and pads.
- Damage to the glass cooktop caused by hardened spills of sugary materials or melted plastic that are not cleaned according to the directions in the Owner's Manual.
- Replacement of house fuses or resetting of circuit breakers.
- Damage to the product caused by accident, fire, floods or acts of God.
- Incidental or consequential damage caused by possible defects with this appliance.
- Damage caused after delivery.

This warranty is extended to the original purchaser and any succeeding owner for products purchased for home use within the USA. In Alaska, the warranty excludes the cost of shipping or service calls to your home.

Some states do not allow the exclusion or limitation of incidental or consequential damages. This warranty gives you specific legal rights, and you may also have other rights which vary from state to state. To know what your legal rights are, consult your local or state consumer affairs office or your state's Attorney General.

Safety Instructions
Operating Instructions
Care and Cleaning
Troubleshooting Tips
Consumer Support

Consumer Support.



GE Appliances Website

www.GEAppliances.com

Have a question or need assistance with your appliance? Try the GE Appliances Website 24 hours a day, any day of the year! For greater convenience and faster service, you can now download Owner's Manuals, order parts, catalogs, or even schedule service on-line. You can also "Ask Our Team of Experts™" your questions, and so much more...



Schedule Service

www.GEAppliances.com

Expert GE repair service is only one step away from your door. Get on-line and schedule your service at your convenience 24 hours any day of the year! Or call 800.GE.CARES (800.432.2737) during normal business hours.



Real Life Design Studio

www.GEAppliances.com

GE supports the Universal Design concept—products, services and environments that can be used by people of all ages, sizes and capabilities. We recognize the need to design for a wide range of physical and mental abilities and impairments. For details of GE's Universal Design applications, including kitchen design ideas for people with disabilities, check out our Website today. For the hearing impaired, please call 800.TDD.GEAC (800.833.4322).



Extended Warranties

www.GEAppliances.com

Purchase a GE extended warranty and learn about special discounts that are available while your warranty is still in effect. You can purchase it on-line anytime, or call 800.626.2224 during normal business hours. GE Consumer Home Services will still be there after your warranty expires.

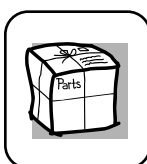

Parts and Accessories

www.GEAppliances.com

Individuals qualified to service their own appliances can have parts or accessories sent directly to their homes (VISA, MasterCard and Discover cards are accepted). Order on-line today, 24 hours every day or by phone at 800.626.2002 during normal business hours.

Instructions contained in this manual cover procedures to be performed by any user. Other servicing generally should be referred to qualified service personnel. Caution must be exercised, since improper servicing may cause unsafe operation.

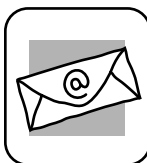

Contact Us

www.GEAppliances.com

If you are not satisfied with the service you receive from GE, contact us on our Website with all the details including your phone number, or write to: General Manager, Customer Relations
GE Appliances, Appliance Park
Louisville, KY 40225



Register Your Appliance

www.GEAppliances.com

Register your new appliance on-line—at your convenience! Timely product registration will allow for enhanced communication and prompt service under the terms of your warranty, should the need arise. You may also mail in the preprinted registration card included in the packing material.