

DOUBLE BURNER



Model Number:
169166
UPC: 681131691666

Customer Assistance

1 877 207 0923 (US)
1 877 556 0973 (Canada)



Thank you for purchasing this GE appliance.

In keeping with the GE ecomagination initiative, please consider the option to recycle the packaging material and donate any appliance you are no longer using.

To read more about GE's ecomagination commitment, visit:
ge.ecomagination.com

IMPORTANT SAFEGUARDS

When using electrical appliances, basic safety precautions should always be followed to prevent the risk of fire, electric shock, burns, or other injuries or damages.

- **Read all instructions before use.**
- Do not touch hot surfaces. Use handles or knobs.
- To protect against electrical shock do not immerse cord, plugs, or the appliance in water or other liquids.
- Close supervision is necessary when any appliance is used by or near children.
- Unplug from outlet when not in use and before cleaning. Allow it to cool before putting on or taking off parts and before cleaning the appliance.
- Do not operate appliance with a damaged cord or plug, or after the appliance malfunctions or has been dropped or damaged in any manner. Call our toll-free customer assistance number for information on examination, repair, or adjustment.
- The use of accessory attachments not recommended by the appliance manufacturer may cause injuries.
- Do not use outdoors or in a damp area.
- Do not let cord hang over edge of table or counter, or touch hot surfaces.
- Do not place on or near a hot gas or electric burner, or in a heated oven.
- Extreme caution must be used when moving an appliance containing hot oil or other hot liquids. Do not move during operation.
- To disconnect, turn the control dial fully counterclockwise to position ● (ill. (d)), then remove plug from the wall outlet.
- Do not use this appliance for anything other than its intended use.
- This appliance is for **HOUSEHOLD USE ONLY**.

SAVE THESE INSTRUCTIONS!

ADDITIONAL SAFEGUARDS

DO NOT OPERATE APPLIANCE IF THE LINE CORD SHOWS ANY DAMAGE OR IF APPLIANCE WORKS INTERMITTENTLY OR STOPS WORKING ENTIRELY.

EXTENSION CORDS

A short power-supply cord is to be provided to reduce the risk resulting from becoming entangled in or tripping over a longer cord. Longer detachable power-supply cords or extension cords are available and may be used if care is exercised in their use. If a longer detachable power-supply cord or extension cord is used,

- 1) The marked electrical rating of the cord set or extension cord should be at least as great as the electrical rating of the appliance, and
- 2) The extension cord should be a grounding-type 3-wire cord, and
- 3) The longer cord should be arranged so that it will not drape over the countertop or tabletop where it can be tripped over, snagged, or pulled on unintentionally (especially by children).

GROUNDING INSTRUCTIONS

This appliance must be grounded while in use.

CAUTION: To ensure continued protection against risk of electric shock, connect to properly ground outlets only.

GROUNDING INSTRUCTIONS – US ONLY

The appliance has a plug that looks like Figure A. An adaptor, as shown in Figure B, should be used for connecting a 3-prong grounding plug to a 2-wire receptacle. The grounding tab, which extends from the adaptor, must be connected to a permanent ground such as a properly grounded receptacle as shown in Figure C, using a metal screw.

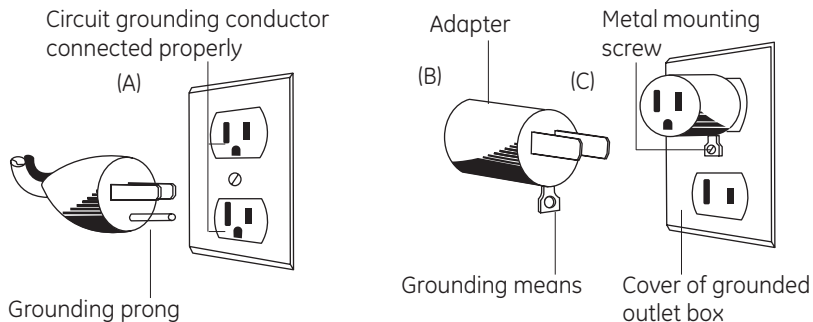

PARTS

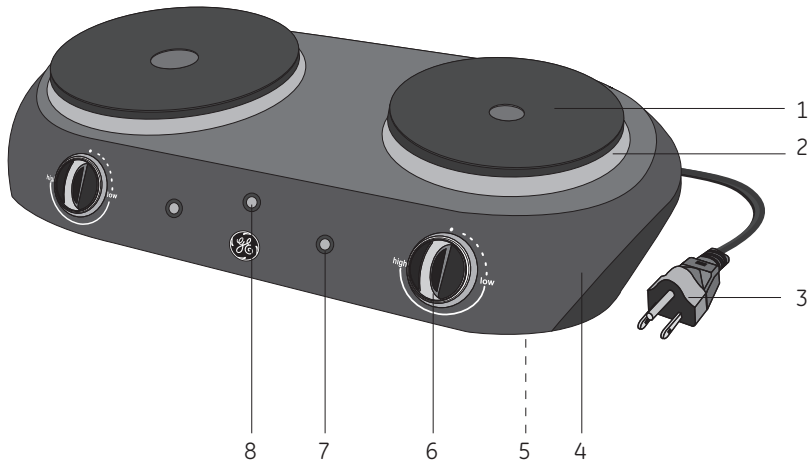

1. Burner
2. Burner Ring
3. Power plug
4. Housing unit
5. Anti-slip feet
6. Temperature control dial (main dial positions: ●, **low**, **high**)
7. Work indicator light
8. Power-on indicator light

ILLUSTRATIONS

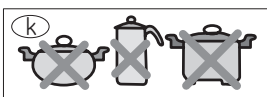
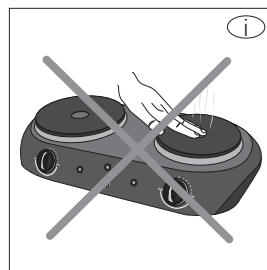
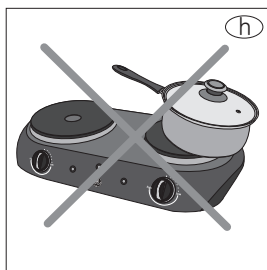
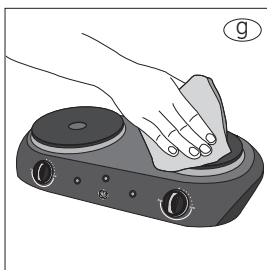
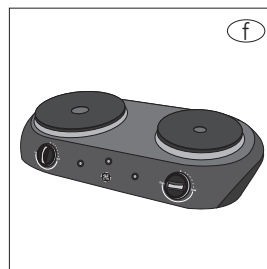
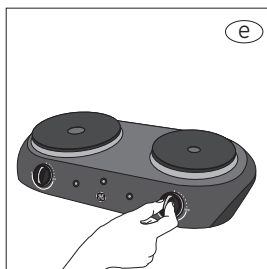
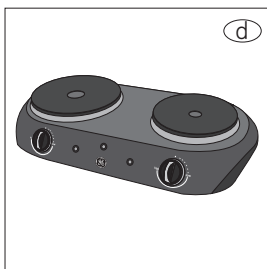
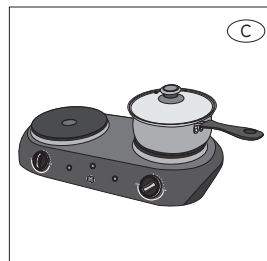
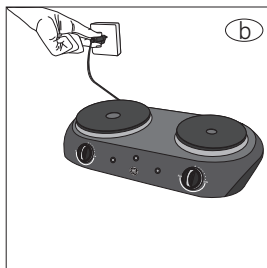
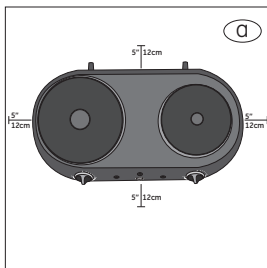

OPERATION

Before first use







- Remove all packaging materials, labels and/or stickers from your double burner.
- Clean your double burner thoroughly before using for the first time (↳ *Cleaning*).

NOTE: Due to the manufacturing process, the double burner may emit a slight burning odor when it is first activated. Use the double burner in a well-ventilated area, select the highest setting (*ill.* ) , and allow it to sit for a few minutes without any cooking utensils.

Operating instructions

There are 2 burner rings on the appliance. The larger burner is rated at 1000 W. The smaller burner is rated at 500 W. Use the larger burner for fast cooking, and use the small burner for simmering or warming.

Before plugging in your double burner, check to ensure that the electrical circuit is not overloaded with other appliances. This appliance should always be operated on a separate 120 V ~60 Hz, AC outlet.

- Place the double burner on a flat, even, and heat-resistant countertop surface.
- Be sure to leave at least 5 inches of space around the appliance for proper ventilation (*ill.* 
- Insert the plug **(3)** into the wall outlet. The blue power-on indicator light **(8)** illuminates immediately (*ill.* 
- Put a pot or pan on the center of one burner **(1)** (*ill.* 
- Always use a pot or pan the same size as the burner (*ill.* 
- Do not use pots or pans that are unstable and easily tipped (*ill.* h+k).
- Turn the temperature control dial **(6)** clockwise from the off position ● to the desired setting (from **low** to **high**) (*ill.* 
- When one burner is working, the red work indicator light **(7)** beside the working burner illuminates.
- When you are done, turn the temperature control dial **(6)** to off position ● (*ill.* 
- When not in use, unplug the double burner from the wall outlet to make sure that it is completely off. The power-on indicator light **(8)** goes off. This helps prevent accidental burns.

WARNING: This appliance generates heat and steam during use. Proper precautions must be taken to prevent the risk of burns, fires, or other injury to persons or damage to property.

CAUTION: The metal surfaces of the double burner and pots/pans will get hot. Do not touch while in use (*ill.* - Allow the appliance to cool for at least 30 minutes before handling.

CLEANING

Proper maintenance will ensure many years of service from your appliance. Clean the double burner after every use. This appliance contains no user serviceable parts and requires little maintenance. Leave any servicing or repairs to qualified personnel.

CAUTION: Before cleaning and storing, turn the temperature control dial **(6)** to the fully counterclockwise position ● (ill. ④). Unplug the double burner from the wall outlet to prevent electric shock, and let the double burner cool down completely.

- Use a damp, soapy cloth or sponge to clean the surface of the double burner (ill. ⑨).

Kind of soiling	Procedure
light soiling	♦ wipe with a damp cloth or sponge
sticky soiling	♦ scrape off and wipe with a damp cloth
lime residue (caused by over boiling water)	♦ remove with vinegar or a mild detergent

- Do not use chemical abrasive cleaners, steel wool, or scouring pads.
- Wipe soap completely from the burner **(1)** and burner ring **(2)** after cleaning.

WARNING: Never immerse the appliance in water or other liquids.

TROUBLESHOOTING

Problem	Solution
Double burner is not working.	♦ Check the power connection. The plug (3) should be inserted properly in the outlet.
Double burner emits smoke or vapor.	♦ Switch off the burner completely, let it cool down, and clean the burner.

If additional assistance is needed, please contact our Customer Assistance at 1.877.207.0923 (U.S.) or 1.877.556.0973 (Canada).

TECHNICAL DATA

Rated voltage:	120V ~60Hz
Rated current:	12.5 A
Rated power input:	1500 W

CUSTOMER ASSISTANCE

If you have a claim under this warranty, please call our Customer Assistance Number. For faster service, please have the model number and product name ready for the operator to assist you. This number can be found on the bottom of your appliance and on the front page of this manual.

Model Number: _____ **Product Name:** _____

Customer Assistance Number 1.877.207.0923 (U.S.) or 1.877.556.0973 (Canada).

Keep these numbers for future reference!

For more information, please visit us at WWW.GEHOUSEWARES.COM

Two-year limited warranty

What does your warranty cover?

- Any defect in material or workmanship.

For how long after the original purchase?

- Two years.

What will we do?

- Provide you with a new one.
- For those items still under warranty but no longer available, WAL-MART reserves the right to replace with a similar GE branded product of equal or greater value.

How do you make a warranty claim?

- Save your receipt.
- Properly pack your unit. We recommend using the original carton and packing materials.
- Return the product to your nearest WAL-MART store or call Customer Assistance at 1-877-207-0923 (U.S.) or 1-877-556-0973 (Canada).

What does your warranty not cover?

- Parts subject to wear, including, without limitation, glass parts, glass containers, cutter/strainer, blades, seals, gaskets, clutches, motor brushes, and/or agitators, etc.
- Commercial use or any other use not found in printed directions.
- Damage from misuse, abuse, or neglect, including failure to clean product regularly in accordance with manufacturer's instructions.

How does state law relate to this warranty?

- This warranty gives you specific legal rights, and you may also have other rights which vary from state to state or province to province.
- This warranty is in lieu of any other warranty or condition, whether express or implied, written or oral, including, without limitation, any statutory warranty or condition of merchantability or fitness for a particular purpose.
- WAL-MART, GE and the product manufacturer expressly disclaim all responsibility for special, incidental, and consequential damages or losses caused by use of this appliance. Any liability is expressly limited to an amount equal to the purchase price paid whether a claim, however instituted, is based on contract, indemnity, warranty, tort (including negligence), strict liability, or otherwise. Some states or provinces do not allow this exclusion or limitation of incidental or consequential losses, so the foregoing disclaimer may not apply to you.

What if you encounter a problem with this product while using it outside the country of purchase?

- The warranty is valid only in the country of purchase and if you follow the warranty claim procedure as noted.



is a trademark of General Electric Company and is used under the license by Wal-Mart Stores Inc., Bentonville, AR 72716

Marketed in Canada by:

Wal-Mart Canada Corp.
1940 Argentia Road, Mississauga,
Ontario L5N1P9