

Gas Cooker Models GSMS, GBC and GC Installation and Operation Manual



Frymaster®



CFESA
Commercial Food Equipment Service Association

Frymaster, a member of the Commercial Food Equipment Service Association, recommends using CFESA Certified Technicians.

24-Hour Service Hotline 1-800-551-8633

NOVEMBER 2001
8195311 ~

⚠ DANGER

IMPROPER INSTALLATION, ADJUSTMENT, ALTERATION, SERVICE, OR MAINTENANCE CAN CAUSE PROPERTY DAMAGE, INJURY, OR DEATH. READ THE INSTALLATION, OPERATING, AND SERVICE INSTRUCTIONS THOROUGHLY BEFORE INSTALLING OR SERVICING THIS EQUIPMENT.

⚠ DANGER

FOR YOUR SAFETY, DO NOT STORE OR USE GASOLINE OR OTHER FLAMMABLE LIQUIDS OR VAPORS IN THE VICINITY OF THIS OR ANY OTHER APPLIANCE.

⚠ DANGER

POST IN A PROMINENT LOCATION THE INSTRUCTIONS TO BE FOLLOWED IN THE EVENT THE USER SMELLS GAS. THIS INFORMATION SHALL BE OBTAINED BY CONSULTING THE LOCAL GAS SUPPLIER.

THIS EQUIPMENT IS TO BE INSTALLED IN COMPLIANCE WITH THE BASIC PLUMBING CODE OF THE BUILDING OFFICIALS AND CODE ADMINISTRATORS INTERNATIONAL, INC. (BOCA) AND THE FOOD SERVICE SANITATION MANUAL OF THE FOOD AND DRUG ADMINISTRATION.

COMPUTERS

FCC

This device complies with Part 15 of the FCC rules. Operation is subject to the following two conditions: 1) This device may not cause harmful interference, and 2) This device must accept any interference received, including interference that may cause undesired operation. While this device is a verified Class A device, it has been shown to meet the Class B limits.

CANADA

This digital apparatus does not exceed the Class A or B limits for radio noise emissions as set out by the ICES-003 standard of the Canadian Department of Communications.

Cet appareil numerique n'emmet pas de bruits radioelectriques depassany les limites de classe A et B prescrites dans la norme NMB-003 edictee par le Ministre des Communcations du Canada.

⚠ DANGER

THIS PRODUCT CONTAINS CHEMICALS KNOWN TO THE STATE OF CALIFORNIA TO CAUSE CANCER AND/OR BIRTH DEFECTS OR OTHER REPRODUCTIVE HARM.

Operation, installation, and servicing of this product could expose you to airborne particles of glasswool or ceramic fibers, crystalline silica, and/or carbon monoxide. Inhalation of airborne particles of glasswool or ceramic fibers is known to the State of California to cause cancer. Inhalation of carbon monoxide is known to the State of California to cause birth defects or other reproductive harm.

FRYMASTER FRYERS EQUIPPED WITH LEGS ARE FOR PERMANENT INSTALLATION. FOR MOVEABLE OR PORTABLE INSTALLATION, FRYMASTER OPTIONAL EQUIPMENT CASTERS MUST BE USED.

QUESTIONS??? CALL 1-800-551-8633.

NOTICE

The Commonwealth of Massachusetts requires any and all gas products to be installed by a licensed plumber.

GAS COOKERS GSMS, GBC AND GC INSTALLATION AND OPERATION MANUAL TABLE OF CONTENTS

CHAPTER 1: General Information

1.1	Applicability and Validity.....	1-1
1.2	Parts Ordering and Service Information	1-1
1.3	Safety Information	1-2
1.4	European Community (CE) Specific Information	1-2
1.5	Equipment Description	1-2
1.6	Installation, Operating, and Service Personnel	1-3
1.7	Definitions.....	1-3
1.8	Shipping Damage Claim Procedure.....	1-4

CHAPTER 2: Installation Instructions

2.1	General Installation Requirements.....	2-1
2.2	Caster/Leg Installation	2-3
2.3	Pre-Connection Preparations	2-4
2.4	Connection to Gas Line	2-6
2.5	Converting to Another Gas Type.....	2-8

CHAPTER 3: Operating Instructions

3.1	Introduction.....	3-1
3.2	Operating Instructions.....	3-2
3.3	Shutting the Cooker Down.....	3-4

CHAPTER 4: Preventive Maintenance

4.1	Daily Preventive Maintenance.....	4-1
4.2	Cleaning the Gas Valve Vent Tube	4-2
4.3	Cleaning and Adjusting the Combustion Air Blower	4-2
4.4	Adjusting the Burner Gas Pressure	4-4
4.5	Measuring Flame Current	4-5
4.6	Controller Simmer Mode Adjustment	4-5

CHAPTER 5: Operator Troubleshooting

5.1	Introduction.....	5-1
5.2	Operator Troubleshooting Guides.....	5-2
5.3	Wiring Diagram	5-5
5.4	Replacing the Controller or Controller Wiring Harness.....	5-6

GAS COOKERS GSMS, GBC, AND GC INSTALLATION AND OPERATION MANUAL CHAPTER 1: GENERAL INFORMATION

RETAIN AND STORE THIS MANUAL IN A SAFE PLACE FOR FUTURE USE

1.1 Applicability and Validity

The GSMS/GBC/GC model family has been approved by the European Union for sale and installation in the following EU countries AT, BE, DE, DK, ES, FI, FR, GB, IE, IT, LU, NL, NO, PT, AND SE.

This manual is applicable to and valid for all GSMS/GBC/GC units sold in English-speaking countries, including those in the European Union. Where conflicts exist between instructions and information in this manual and local or national codes of the country in which the equipment is installed, installation and operation shall comply with those codes.

This appliance is only for professional use and shall be used by qualified personnel only, as defined in Section 1.7.

1.2 Parts Ordering and Service Information

In order to assist you quickly, the Frymaster Factory Authorized Service Center (FASC) or Service Department representative requires certain information about your equipment. Most of this information is printed on data plate affixed to the inside of the cooker door. Part numbers are found in the Installation, Operation, Service, and Parts Manual. Parts orders may be placed directly with your local FASC or distributor. A list of Frymaster FASCs was included with this equipment. If you do not have access to this list, contact the Frymaster Service Department at 1-800-551-8633 or 1-318-865-1711.

When ordering parts, the following information is required:

Model Number: _____
Serial Number: _____
Type of Gas or Voltage: _____
Item Part Number: _____
Quantity Needed: _____

Service information may be obtained by contacting your local FASC/Distributor. Service may also be obtained by calling the Frymaster Service Department at 1-800-551-8633 or 1-318-865-1711. When requesting service, please have the following information ready:

Model Number: _____
Serial Number: _____
Type of Gas: _____

In addition to the model number, serial number, and type of gas, please be prepared to describe the nature of the problem and have ready any other information that you think may be helpful in solving your problem.

1.3 Safety Information

Before attempting to operate your unit, read the instructions in this manual thoroughly.

Throughout this manual, you will find notations enclosed in double-bordered boxes similar to the one below.

CAUTION boxes contain information about actions or conditions that *may cause or result in a malfunction of your system.*



WARNING boxes contain information about actions or conditions that may cause or result in damage to your system, and may cause your system to malfunction.



DANGER boxes contain information about actions or conditions that may cause or result in injury to personnel, and may cause damage to your system and/or cause your system to malfunction.

1.4 European Union (EU) Specific Information

The European Union (EU) has established certain specific standards regarding equipment of this type. Equipment approved for use in EU countries is marked with the  symbol. Whenever a conflict exists between CE and non-CE standards or when CE-unique requirements exist, the information or instructions concerned are identified by means of shadowed boxes similar to the ones below.

CE Standard for Incoming Gas Pressures			
Gas	Normal (Pn) (mbar) ⁽¹⁾	Minimum (Pmin) (mbar) ⁽¹⁾	Maximum (Pmax) (mbar) ⁽¹⁾
G20	20	17	25
G25	20 or 25	20	30
G31	30 or 37	25	35 or 45
G31	50	42,5	57,5

(1) mbar = 10,2mm H₂O

Non-CE Standard for Incoming Gas Pressures		
Gas	Minimum	Maximum
Natural	6.0" WC	14" WC
	1.62 kPa	3.48 kPa
	16.19 mbar	34.87 mbar
Propane	11" WC	14" WC
	2.74 kPa	3.48 kPa
	27.37 mbar	34.87 mbar

1.5 Equipment Description

Frymaster GSMS/GBC/GC gas cookers are specifically designed to deliver high volumes of cooked or blanched food automatically. All models feature a unique infrared burner system that

delivers 80,000 BTUs (23.4 kW – 84.4, megajoules) to cook 10 pounds (4.5kg) of dry pasta per bulk basket. The cooker can also be used to reheat up to 12 10-ounce (0.28kg) packages of pre-cooked food at a time. The cookpot measures 18 x 24 x 8 inches (457 x 610 x 203 mm) and holds 2.7 gallons (48-liters) of water.

Model Comparison:

GSMS: The “Gas Spaghetti Magic System” consists of a gas cooker and rinse tank combination. The unit is equipped with a programmable controller that controls water temperature, water level, and cooking times. A swing-away water faucet is standard. An automatic basket lift system lowers and raises either bulk or individualized portions of pasta or other food products according to times programmed by the operator. Options include automatic water filling (Autofill) and starch skimming (Autoskim). The Autofill feature maintains the cookpot water level approximately 1/4-inch (32mm) below the overflow drain. The Autoskim feature sprays water on the surface of the water, forcing starch to the overflow drain. This eliminates loss of cooking time associated with removing excess starch buildup. It also keeps the water in the cookpot at the optimum level by replacing water evaporated during the cooking process. The Autoskim feature also saves energy since there is no need to refill and reheat the cookpot periodically. The cookpot is safeguarded against over filling and boilover by a large overflow drain. “SD” following the model designation indicates a stainless steel cookpot and door, and enameled cabinet. “SC” following the model designation indicates all stainless steel components.

GBC/GC: These standalone cookers are essentially the same as the GSMS, but without the built-in rinse tank. **GBC** models have an automatic basket lift and optional automatic water filling and starch skimming. **GC** models have no basket lifts and no automatic water filling and starch skimming options. The cookpot in both is safeguarded against over filling and boilover by a large overflow drain. “SD” following the model designation indicates a stainless steel cookpot and door, and an enameled cabinet. “SC” following the model designation indicates all stainless steel components.

1.6 Installation, Operating, and Service Personnel

All installation and service on Frymaster equipment must be performed by qualified, certified, licensed, and/or authorized installation or service personnel, as defined in Section 1.7.

1.7 Definitions

QUALIFIED INSTALLATION PERSONNEL

Qualified installation personnel are individuals, firms, corporations, and/or companies which, either in person or through a representative, are engaged in and are responsible for the installation of gasfired appliances. Qualified personnel must be experienced in such work, be familiar with all gas precautions involved, and have complied with all requirements of applicable national and local codes.

QUALIFIED OPERATING PERSONNEL

Qualified operating personnel are those who have carefully read the information in this manual and have familiarized themselves with the equipment functions, or who have had previous experience with the operation of the equipment covered in this manual.

QUALIFIED SERVICE PERSONNEL

Qualified service personnel are those who are familiar with Frymaster equipment and who have been authorized by Frymaster Corporation to perform service on Frymaster equipment. All authorized service personnel are required to be equipped with a complete set of service and parts manuals, and to stock a minimum amount of parts for Frymaster equipment. A list of Factory Authorized Service Centers (FASC) was included with the cooker when shipped from the factory. ***Failure to use qualified service personnel will void the Frymaster Warranty on your equipment.***

1.8 Shipping Damage Claim Procedure

Your Frymaster equipment was carefully inspected and packed before leaving the factory. The transportation company assumes full responsibility for safe delivery upon its acceptance of the equipment for transport.

What to do if your equipment arrives damaged:

1. **File a claim for damages immediately**, regardless of the extent of damages.
2. **Inspect for and record all visible loss or damage**, and ensure that this information is noted on the freight bill or express receipt and is signed by the person making the delivery.
3. **Concealed loss or damage** that was unnoticed until the equipment was unpacked should be recorded and reported to the freight company or carrier immediately upon discovery. A concealed damage claim must be submitted within 15 days of the date of delivery. Ensure that the shipping container is retained for inspection.

**FRYMASTER DOES NOT ASSUME RESPONSIBILITY FOR DAMAGE OR LOSS
INCURRED IN TRANSIT.**

GAS COOKERS GSMS, GBC, AND GC

INSTALLATION AND OPERATION MANUAL

CHAPTER 2: INSTALLATION INSTRUCTIONS

2.1 General Installation Requirements

Qualified, licensed, and/or authorized installation or service personnel, as defined in Section 1.7 of this manual, should perform all installation and service on Frymaster equipment.

Conversion of this appliance from one type of gas to another should only be performed by qualified, licensed, and/or authorized installation or service personnel as defined in Section 1.7 of this manual.

Failure to use qualified, licensed, and/or authorized installation or service personnel (as defined in Section 1.7 of this manual) to install, convert to another gas type or otherwise service this equipment will void the Frymaster warranty and may result in damage to the equipment or injury to personnel.

Where conflicts exist between instructions and information in this manual and local or national codes or regulations, installation and operation shall comply with the codes or regulations in force in the country in which the equipment is installed.

Upon arrival, inspect the cooker carefully for visible or concealed damage. (See **Shipping Damage Claim Procedure** in Chapter 1.)

CLEARANCE AND VENTILATION

The cooker(s) must be installed with 6 inches (150mm) clearance at both sides and back when installed adjacent to combustible construction; no construction; no clearance is required when installed adjacent to noncombustible construction. A minimum of 24 inches (600mm) clearance should be provided at the front of the cooker. To provide the airflow necessary for good combustion and burner operation, the areas surrounding the cooker front, sides, and rear must be kept clear and unobstructed.

 **DANGER**

This appliance must be installed with sufficient ventilation to prevent the occurrence of unacceptable concentrations of substances harmful to the health of personnel in the room in which it is installed.

CE Standard

Required airflow for the combustion air supply is 2m³/h per kW.

One of the most important considerations of efficient cooker operation is ventilation. Cookers must be installed in an area with an adequate air supply and adequate ventilation. Make sure the cooker is

installed so that products of combustion are removed efficiently, and that the kitchen ventilation system does not produce drafts that interfere with proper burner operation.

The cooker flue opening must not be placed close to the intake of the exhaust fan, and the cooker must never have its flue extended in a “chimney” fashion. An extended flue will change the combustion characteristics of the cooker, causing longer recovery time. It also frequently causes delayed ignition.

When installed beneath a ventilation hood, adequate distance must be maintained from the flue outlet of the cooker to the lower edge of the ventilation filter bank. Filters should be installed at an angle of 45° with a drip tray placed beneath the lowest edge of the filter. For U.S. installation, NFPA standard No. 96 states, “ A minimum distance of 18 inches (450mm) should be maintained between the flue outlet and the lower edge of the filter.”

For installations in other than the United States, installers should contact the appropriate local or national agency for information on the construction and installation of ventilating hoods.

ELECTRICAL GROUNDING REQUIREMENTS

All electrically operated appliances must be grounded in accordance with all applicable national and local codes, and where applicable, CE codes. A wiring diagram is located on the inside of the cooker door. Refer to the rating plate on the inside of the cooker door for the proper voltages.

DANGER

If this appliance is equipped with three-prong (grounding) plug, it must be plugged directly into properly grounded receptacle. Do not cut or remove the grounding prong from the plug.

DANGER

**This equipment requires electrical power for operation.
Place the gas control valve in the OFF position in case of a prolonged power outage.
Do not attempt to use the equipment during a power outage.**

NATIONAL CODE REQUIREMENTS

GSMS/GBC/GC cookers are manufactured to use the type of gas specified on the rating plate. The rating plate is attached to the inside of the cooker door. Connect a cooker only to the type of gas indicated on the rating plate.

Installation shall be made with a gas connector that complies with the national and local codes or regulations in force in the country in which the appliance is being installed. Quick-disconnect devices, if used, shall likewise comply with the national and local codes or regulations in force in the country in which the appliance is being installed

When installing GSMS/GBS/GC cookers in the **UNITED STATES**, the installation must conform to the latest edition of the Nation Fuel Gas Code, ANSI Z223.1. In addition, installation must comply

with all local codes. In **CANADA**, installation must conform to Standard CAN/CGA-B149.1 or CAN/CGA-B149.2, *Installation Codes for Gas Burning Appliances and Equipment*. In addition, installation must comply with all local codes. In **AUSTRALIA**, this appliance must be installed by an authorized person in accordance with these instructions, local gas and electrical regulations, and the requirements of AA601, *Installation Requirements for Gas Burning Appliances*.

For countries not specifically listed above, installation shall comply with the national and local codes or regulations in force in the country in which the appliance is being installed.

FCC COMPLIANCE

The user is cautioned that any changes or modifications to Frymaster controllers not expressly approved by the party responsible for compliance could void the user's authority to operate the equipment.

Frymaster controllers have been tested and found to comply with the limits for a Class A digital device, pursuant to Part 15 of the FCC rules. While these devices are verified as Class A devices, they have been shown to meet the Class B limits. These limits are designed to provide reasonable protection against harmful interference when the equipment is operated in a commercial environment. This equipment generates, uses, and can radiate radio frequency energy and, if not installed and used in accordance with the instruction manual, may cause harmful interference to radio communications. Operation of the equipment in residential areas is likely to cause harmful interference in which case the user will be required to correct the interference at his own expense. If necessary, the user should consult the dealer or an experience radio and television technician for additional suggestions. The user may find the booklet "How to Identify and Resolve Radio-TV Interference Problems" helpful. It is prepared by the Federal Communications Commission and is available from the U.S. Government Printing Office, Washington, DC 20402, Stock No. 004-000-00345-4.

2.2 Caster or Leg Installation

Depending upon the specific configuration ordered your cooker may have been shipped without installed casters or legs. If casters or legs are installed, you may skip this section and proceed to Section 2.3, Pre-Connection Preparations.

If your cooker requires the installation of casters or legs, install them in accordance with the instructions included in your accessory package.

2.3 Pre-Connection Preparations

⚠ DANGER

Do not connect cooker to gas supply before completing each step in this section.

After the cooker has been positioned under the exhaust hood, ensure the following has been accomplished:

1. Adequate means must be provided to limit the movement of cookers without depending upon the gas line connections. If a flexible gas hose is used, a restraining cable must be connected at all times when the cooker is in use. The restraining cable and installation instructions are packed with the flexible hose in the accessories box that was shipped with your unit.
2. *Single unit* cookers (GBS/GC) must be stabilized by installing restraining chains on cooker equipped with casters or anchor straps on cooker equipped with legs. Follow the instruction shipped with the casters/legs to properly install the chains or straps.

⚠ DANGER

Do not attach an apron drain board to a single cooker. The cooker may become unstable, tip over, and cause injury. The appliance area must be free and clear of combustible material at all times.

3. Level cookers equipped with legs by screwing out the legs approximately 1 inch then adjusting them so that the cooker is level and at the proper height in the exhaust hood.
NOTE: There are no built-in leveling devices on cookers equipped with casters. The floor where the cooker is to be installed must be level.
4. For GSMS and GBC units, install the basket lift arms onto the rods (located at the top rear of the cabinet), ensuring that the lift arms are guided by the basket lift rollers.
5. Connect the water supply to the faucet and, on units with the Autofill option, the water solenoid valve. (The valve is located on the lower frame behind the doorpost.)

⚠ CAUTION

Before connecting the water supply to units equipped with solenoid valves, purge the water line to ensure there is no trash in the line.

⚠ DANGER

The maximum allowable incoming water pressure to the regulator for all units is 80 PSI (56.3 kg/cm²).

The maximum allowable incoming water temperature for all units is 180°F (82°C).

NOTE: Either hot or cold water supplies may be connected to the water solenoid valve. However, connecting to a hot water supply will minimize the amount of time required to attain operating temperature when filling the cooker with fresh water.

NOTE: In order for the water level sensors to work properly, a certain amount of mineral content is necessary in the water. For that reason, purified, deionized, or highly filtered water should not be used.

6. Connect the desired drain plumbing to the 1¼-inch drain valve.
7. Test the cooker electrical system:
 - a. Plug the cooker electrical cord into a grounded electrical receptacle of appropriate voltage. (Check the rating plate on the cooker door to determine the proper voltage).
 - b. Place the power switch in the **ON** position and verify that the display indicates **-10**.
 - c. Place the cooker power switch in the **OFF** position. Verify that the display is blank.
8. Refer to the rating plate on the inside of the cooker door to verify that the cooker is configured for the types of gas being supplied before connecting the quick-disconnect device or piping from the gas supply line.
9. Refer to the table below to verify the minimum and maximum gas supply pressures for the type of gas being used.

CE Standard for Incoming Gas Pressures			
Gas	Normal (Pn) (mbar)⁽¹⁾	Minimum (Pmin) (mbar)⁽¹⁾	Maximum (Pmax) (mbar)⁽¹⁾
G20	20	17	25
G25	20 or 25	20	30
G31	30 or 37	25	35 or 45
G31	50	42,5	57,5

(1) mbar = 10,2mm H₂O

References for CE Standard are Tables 6 and A.2 of EN 203-1:1993

Non-CE Standard for Incoming Gas Pressures		
Gas	Minimum	Maximum
Natural	6.0" WC	14" WC
	1.62 kPa	3.48 kPa
	16.19 mbar	34.87 mbar
Propane	11" WC	14" WC
	2.74 kPa	3.48 kPa
	27.37 mbar	34.87 mbar

2.4 Connection to the Gas Line

The GSMS/GBC/GC family of gas cookers has been approved for use with natural and propane (LP) gas. The cookers in this family have also received the CE mark for the countries and gas categories indicated in the accompanying table.

CE Standard

The nominal heat input (Qn) is 21kW except for AT, DE, LU and for category 3B/P under 50 mbar, which is 23kW.

CE Approved Gas Categories by Country			
COUNTRIES	CATEGORIES	GAS	PRESSURE (mbar)
AUSTRIA (AT)	II _{2H3B/P}	G20	20
		G31	50
BELGIUM (BE)	I _{2E(R)B}	G20, G25	20, 25
	I ₃₊	G31	37
DENMARK (DK)	II _{2H3B/P}	G20	20
		G31	30
FRANCE (FR)	II _{2Esi3+}	G20,G25	20, 25
		G31	37
	II _{2Esi3P}	G20/G25	20, 25
		G31	50
FINLAND (FI)	II _{2H3B/P}	G20	20
		G31	30
GERMANY (DE)	II _{2ELL3B/P}	G20/G25	20
		G31	50
	I _{3P}	G31	50
GREECE (GR)	II _{2H3+}	G20	20
		G31	37
ITALY (IT)	II _{2H3+}	G20	20
		G31	37
IRELAND (IE)	II _{2H3+}	G20	20
		G31	37
LUXEMBOURG (LU)	II _{2E3B/P}	G20	20
		G31	50
NETHERLANDS (NL)	II _{2L3P}	G25	25
		G31	50
	II _{2L3B/P}	G25	25
		G31	30
NORWAY (NO)	I _{3B/P}	G31	30
PORTUGAL (PT)	II _{2H3+}	G20	20
		G31	37
SPAIN (ES)	II _{2H3+}	G20	20
		G31	G37
	II _{2H3P}	G20	20
		G31	37, 50
SWEDEN (SE)	II _{2H3B/P}	G20	20
		G31	30
UNITED KINGDOM (GB)	II _{2H3+}	G20	20
		G31	37

The size of the gas line used for installation is very important. If the line is too small, the gas pressure at the burner manifold will be low. This may cause slow recovery and delayed ignition. Frymaster recommends the incoming gas supply line be a minimum of 1 ½” (38mm) in diameter. Refer to the chart below for the minimum sizes of connection piping.

Gas Connection Pipe Sizes		
(Minimum incoming pipe size should be 1½” (38 mm))		
Gas	Single Unit	2-3 Units
Natural	¾” (19 mm)	1” (25 mm)
Propane	½” (13 mm)	¾” (19 mm)

For distances of more than 20 feet (6m) and/or more than four fittings or elbows, increase the connection by one pipe size.

Before connecting new pipe to your unit, the pipe must be thoroughly blown out to remove any foreign particles. If these foreign particles get into the burner and controls, they will cause improper and sometimes dangerous operation.

1. Connect the quick-disconnect hose to the cooker quick-disconnect fitting at the rear of the cooker and to the building gas line.

NOTE: Some cookers are configured for a rigid connection to the gas supply line. These units must be connected to the gas supply line at the rear of the unit using fittings approved for that purpose by the appropriate regulatory agency of the county in which the appliance is installed.

NOTE: When using thread compound, use very small amounts on male threads only. Use a pipe thread compound that is not affected by the chemical action of LP gases (i.e. propane, G31) (Loctite™ PST56765 Sealant is one such compound). **DO NOT** apply compound to the first two threads. This will ensure that the burner orifices and control valve do not become clogged.

2. Open the gas supply to the cooker and check all piping, fittings, and gas connections for leaks. A soap solution should be used for this purpose.

 **DANGER**

Never use matches, candles, or any other ignition source to check for leaks. If gas odors are detected, shut off the gas supply to the cooker at the main shut-off valve and contact the local gas company or an authorized service agency for service.

3. Close the cooker drain valve and fill the cookpot with water and detergent. Light the cooker and perform the boil-out procedures that are described in the “Lighting Instructions” and “Boiling Out the Cookpot” topics found in Chapter 3 of this manual.

 **WARNING**

“Dry-firing” this equipment will cause damage to the cookpot. Always ensure that water is in the cookpot before firing your unit.

4. It is recommended that the burner gas pressure be checked at this time by the local gas company or an authorized service agent. Refer to “Check Burner Pressure” in Chapter 4 of this manual for the proper procedure. The accompanying tables list the burner gas pressures for the various gas types that can be used with this equipment.

CE Standard for Burner Gas Pressure	
Gas	Pressure
Natural Lacq (G20) under 20 mbar	7 mbar
Natural Gronique* (G25) under 25 mbar	12 mbar
Propane (G31) under 37 mbar	22,2 mbar
* Belgian G25 = 7,0 mbar	

Non-CE Standard for Burner Gas Pressure	
Gas	Pressure
Natural	3.5" WC
	0.87 kPa
	8.718 mbar
Propane	8.25" WC
	2.05 kPa
	20.55 mbar

2.5 Converting to Another Gas Type

DANGER

Your cooker is configured at the factory for a specific type of gas. If you desire to switch from one type of gas to another, specific gas-conversion components must be installed.

Switching to a different type of gas without installing the proper conversion components may result in fire or explosion! NEVER attach your cooker to a gas supply for which it is not configured.

Conversion of this appliance from one type of gas to another should only be performed by qualified, licensed, and/or authorized installation or service personnel, as defined in Section 1.7 of this manual.

CE Gas Conversion Components

G20 or G25 (Natural) to G31 Gas:	G31 (Propane) to G20 or G25 Gas:
Orifice: 810-1970 (2 required)	Orifice: 810-0916 (2 required)
Ignitor Kit: 826-1715 (2 required)	Ignitor Kit: 826-1714 (2 required)
Conversion Rating Label 802-2144	Conversion Rating Label 802-2144

Non-CE Gas Conversion Components

Natural Gas to LP (Propane) Gas:	LP (Propane) Gas to Natural Gas:
Orifice: 810-0917 (2 required)	Orifice: 810-0916 (2 required)
Ignitor Kit: 826-1715 (2 required)	Ignitor Kit: 826-1714 (2 required)
Regulator: 807-1848 (1 required)	Regulator: 807-1847 (1 required)
Conversion Rating Label 802-2144	Conversion Rating Label 802-2144

CE Gas Conversion Instructions

1. Between G20- and G25- type Natural Gas, adjust the gas pressure at the gas valve regulator. (Refer to the CE Standard for Burner Gas Pressure Table on Page 2-7.) Do not change the orifices.
2. Between a 2nd family (G20 or G25) and a 3rd family gas (G31 Propane):
 - a. Change the orifices.
 - b. Change the ignitors.
 - c. Adjust the incoming gas pressure for the new gas. (Refer to the CE Standard for Incoming Gas Pressure table on Page 2-5).
 - d. Adjust the burner gas pressure at the gas valve regulator. (Refer to the CE Standard for Burner Gas Pressure table on Page 2-8 and adjustment procedure in Chapter 4.)
3. Affix the new label included with the conversion kit next to the existing rating plate stating that the gas type has been converted. Remove any references to the previously used gas from the existing rating plate. Label PN 802-2144
4. If the destination language changes, replace the labels. (You must contact your local service agency or KES for label kit. The language of reference is indicated on the corner of the label.)

Non-CE Gas Conversion Instructions

1. Change the orifices.
2. Change the ignitors.
3. Install the regulator kit in the gas valve in accordance with the instructions furnished with the kit.
4. Adjust the incoming gas pressure for the new gas. (Refer to the Non-CE Standard for Incoming Gas Pressure table on Page 2-5.)
5. Adjust the gas pressure at the gas valve regulator. (Refer to the Non-CE Standard for Burner Gas Pressure table on Page 2-8 and adjustment procedure in Chapter 4.)
6. Affix the new label included with the conversion kit next to the existing rating plate stating that the gas type has been converted. Remove any references to the previously used gas from the existing rating plate. Label PN 802-2144
7. If the destination language changes, replace the labels. (You must contact your local service agency or KES for a label kit. The language of reference is indicated on the corner of the label.)

GAS COOKERS GSMS, GBC, AND GC INSTALLATION AND OPERATION MANUAL CHAPTER 3: OPERATING INSTRUCTIONS

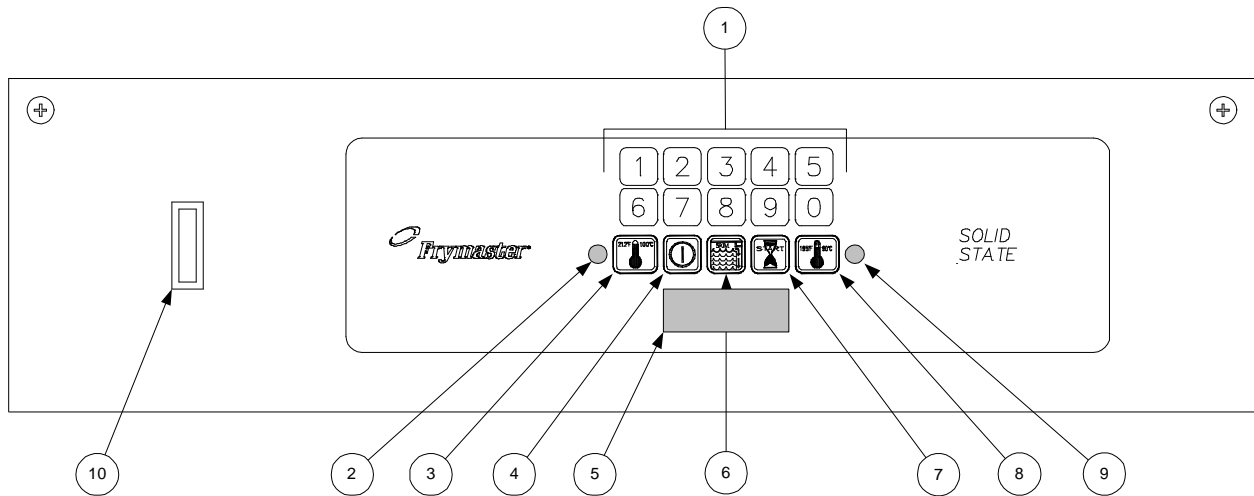

1	Numeric Keypad	6	Skim Switch
2	Boil Mode Indicator	7	Timer Start Switch
3	Boil Mode Switch	8	Simmer Mode Switch
4	Power Switch	9	Simmer Mode Indicator
5	LED Display	10	Trouble Light

3.1 Introduction

The Spaghetti Magic Controller allows the operator to specify a cook time in minutes and seconds, then initiate a cooking cycle. This controller is available in three configurations. The standard configuration has both automatic filling (Autofill) and automatic skimming (Autoskim) features. Options include Autofill only, or neither Autofill nor Autoskim.

When in the **BOIL** mode, the burners are lit at all times. It is used when actually cooking pasta.



The **SIMMER** mode feature maintains the water temperature just below boiling, which conserves energy and water. This feature is designed for rethermalizing previously cooked packaged products and for keeping the cooker in standby.

The **AUTOSKIM** and **SKIM** features are independent of each other. The **AUTOSKIM** feature, on units so equipped, adds water for approximately 3 seconds once a minute. It cannot be turned off. The **SKIM** feature, when activated by pressing the skim button on the controller, delivers a continuous spray of water for approximately 2 minutes, then stops until the button is again pressed. In both cases, the purpose is to cause the water in the cookpot to overflow into the drain, carrying floating starch with it. (A buildup of starch reduces the efficiency of the cooker and can cause erroneous temperature and water level sensing.)

LOW WATER SENSING automatically closes the gas valve (thereby extinguishing the burner flame) if the water in the cookpot drops too low. When the water level in the cookpot is below the low-water sensor, such as when draining and cleaning the cookpot, the controller display will read **L0**.

NORMAL WATER LEVEL SENSING, on units configured with the Autofill feature, automatically adds water during or after a cooking cycle if the water in the cookpot drops to a level lower than approximately 1¼-inch (32 mm) below the overflow drain. With this automatic filling feature, the water level does not have to be continuously monitored. The cookpot always has the correct amount of water.

FAHRENHEIT OR CELSIUS TEMPERATURE DISPLAY

There are two versions of the SMS Controller: one that can be toggled between Fahrenheit and Celsius temperature display, and one that cannot. To determine which version you have, turn the controller off by pressing the power  switch. The display will go blank. Press the Simmer  (right thermometer icon) switch. If **Code** appears in the display, the temperature display can be changed. If not, the display cannot be changed.

1. If **Code** appears in the display, press 1, 6, 5, 8. The display will be toggled from Fahrenheit to Celsius or from Celsius to Fahrenheit.
2. Press the Boil  (left thermometer icon) switch to display the cookpot temperature. If an **F** follows the temperature, the display is in Fahrenheit; if a **C** follows the temperature, the display is in Celsius.

3.2 Operating Instructions

Before turning the cooker on, ensure that:

- the unit is connected to the water supply.
- the water supply is turned on
- the unit is plugged in to an appropriate outlet.
- the electrical power supply is turned on
- the gas supply is turned on.

3.2.1 Start-up Procedure

CAUTION

If this is the first time the unit is being used after installation, refer also to Section 3.2.3, *Boiling Out the Cookpot*.

1. Press the power  switch to the **ON** position. If the cooker is equipped with the Autofill option, the cookpot will automatically begin to fill with water. If not, manually fill the cookpot using the faucet until the water level is above the upper water level sensor located at the left front of the cookpot as you face the unit. (On units with Autofill, the water will automatically shut off when the water in the cookpot has reached the correct level.)

2. On Non-CE units, turn the gas valve knob to the **ON** position (see illustration at right.) **NOTE:** CE gas valves do not have an **ON/OFF** knob. These valves will activate automatically when the controller power switch is placed in the ON position and the lower water level sensor is covered with water.

The burners should light for several seconds and then go out. A few seconds later they should light again. This cycle will repeat about 10 times, at which time the burners should remain lit until the setpoint is reached.

If the burners fail to light, press the power  switch to the **OFF** position, wait 60 seconds, then repeat this step.

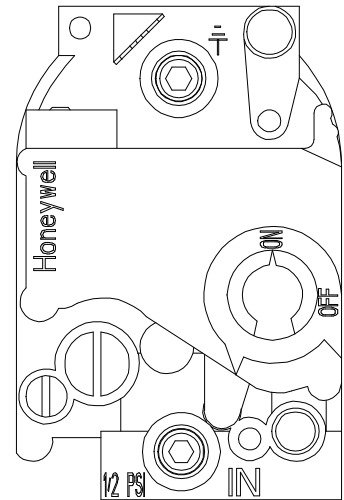





3. After the burners have been lit continuously for at least 90 seconds, observe the burners through the burner viewports. They should display a bright orange-red glow. If a blue flame is observed, or if there are dark spots on a burner face, the air gas mixture requires adjustment, as explained below.

NOTE: Adjusting the Air/Gas Mixture:

On the side of the blower housing opposite the motor is a plate with one or two locking nuts. Loosen the nut(s) enough to allow the plate to be moved, then adjust the position of the plate to open or close the air intake opening until a bright orange-red glow. Carefully hold the plate in position and tighten the lock nut(s).

3.2.2 Normal Operation

1. Turn the controller on by pressing the power  switch.
2. The unit will automatically enter the boil mode and the boil mode indicator will illuminate. If you do not intend to immediately begin cooking, press the Simmer Mode  switch. The simmer mode indicator will illuminate. To re-enter the boil mode, press the Boil Mode  switch.
3. Enter the desired cooking time using the numeric keypad. The time entered appears in the LED display.
4. When ready to initiate a cooking cycle, press the Start Timer  switch. The basket lift (on units so equipped) will automatically lower the basket or portion cups into the cookpot and the LED display will begin to count down. At the end of the cooking cycle, an alarm will sound briefly to alert you and the basket lift will automatically raise the basket or portion cups out of the water.

The display will automatically return to the previously set cooking time. If the same time is desired for the next batch, simply press the Start Timer  switch when ready, otherwise enter the new cooking time before pressing the switch.

5. To initiate the skim feature, press the Skim  switch.

3.2.3 Boiling Out the Cookpot

To ensure that the cooker is free of contamination from manufacture, shipping, or handling during installation, the cookpot must be boiled out before first use.

1. Close the drain valve and fill the cookpot with a mixture of cold water and 1 cup of detergent.
2. Place the unit into operation (see Section 3.2.1).
3. Press the Simmer Mode switch  and allow the solution to simmer for at least 1 hour.
4. After the solution simmers for 1 hour, turn the unit off and add cold water until the solution is cool. Drain the solution and clean the cookpot thoroughly with a solution of dishwashing detergent and hot water.
5. Rinse the cookpot at least twice by filling with clean water and draining. Dry the cookpot thoroughly with clean, dry towel.
6. For units equipped with a rinse tank, clean the tank with a solution of dishwashing detergent and hot water. Drain the tank and dry it thoroughly with a clean, dry towel.

3.3 Shutting the Cooker Down

Turn the unit off by pressing the power  switch. If shutting down at the end of the day, place the gas valve in the OFF position (Non-CE units), drain and clean the cookpot (and rinse tank, if so equipped), and put the cookpot and rinse tank covers in place.

GAS COOKERS GSMS, GBC, AND GC INSTALLATION AND OPERATION MANUAL CHAPTER 4: PREVENTIVE MAINTENANCE

4.1 Daily Preventive Maintenance

It is normal for a coating of starch to form on the sensors and temperature probes during operation. If the coating is allowed to build-up, it will adversely affect the operation of the equipment. The preventive maintenance routines below should be performed at least daily to keep your equipment functioning at peak efficiency. The cookpot and rinse tank – especially the water-level sensors and the temperature probe – may require more frequent cleaning, depending upon the product volume.

Inspect Equipment and Accessories for Damage

Look for loose or frayed wires and cords, leaks, foreign material in cookpot or inside cabinet, and any other indications that the equipment and accessories are not ready for safe operation.

Clean Cabinet Inside and Out

Clean inside the cabinet with a dry, clean cloth. Wipe all accessible metal surfaces and components to remove accumulations of oil, dust, or cooking residue.

Clean the outside of the cabinet with a clean cloth dampened with dishwashing detergent, removing oil, dust, or cooking residue.

 **DANGER**

Never attempt to clean this equipment during the cooking process or when the cookpot is filled with hot water and/or food products.

Clean Water-Level Sensors, Temperature Probe, Cookpot, and Rinse Tank

1. Turn the equipment off and drain the cookpot (and rinse tank, if so equipped).
2. Remove the probe cover and clean the water-level sensors and temperature probe using a Scotchbrite™ or similar abrasive pad and a solution of detergent and water.
3. Using a Scotchbrite™ or similar abrasive pad and a solution of detergent and water, clean the inside of the cookpot (and rinse the tank, if so equipped).
4. Rinse the cookpot (and rinse tank, if so equipped) thoroughly with clean water at least twice.

4.2 Cleaning the Gas Valve Vent Tube

This procedure should be performed at least once every 90 days.

NOTE: This procedure is not required for cookers configured for export to CE countries. The gas valves on CE units are not equipped with vent tubes.

1. Set the power switch and the gas valve to the OFF position.
2. Carefully unscrew the vent tube from the gas valve. NOTE: The vent tube may be straightened for ease in removal.
3. Pass a piece of ordinary binding wire (.052 inch diameter) through the tube to remove any obstruction.
4. Remove the wire and blow through the tube to ensure it is clear.
5. Reinstall the tube and bend it so that the opening is pointing downward.

4.3 Cleaning and Adjusting the Combustion Air Blower

1. Unplug the cooker. Mark and disconnect the four wires running from the motor at the inline connectors.
2. Remove the four nuts and bolts securing the blower to mounting bracket. Remove the blower from the cooker.
3. Remove the three fasteners that secure the blower motor assembly to the blower housing, and separate the two components.

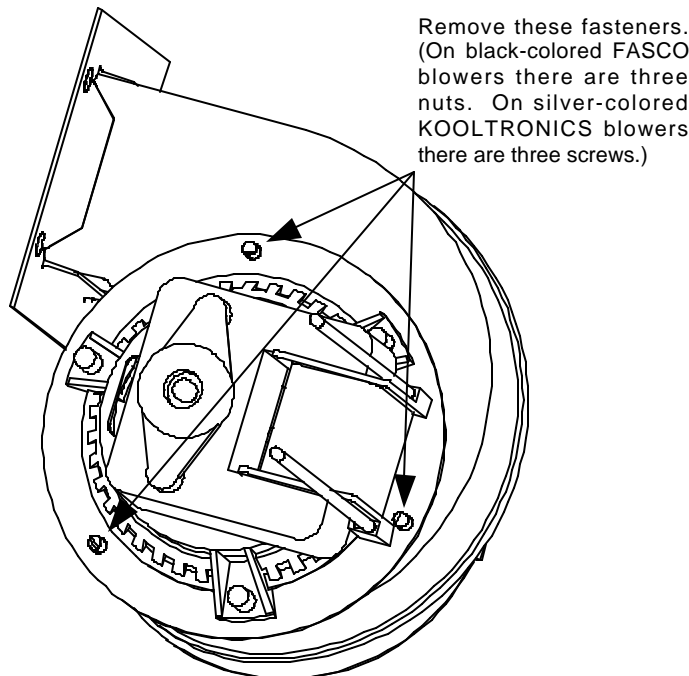

4. Wrap the motor with plastic wrap to prevent water from entering it. Spray degreaser or detergent on the blower wheel and the blower housing. Allow it to soak for five minutes. Rinse the wheel and housing with hot tap water, then dry with a clean cloth.

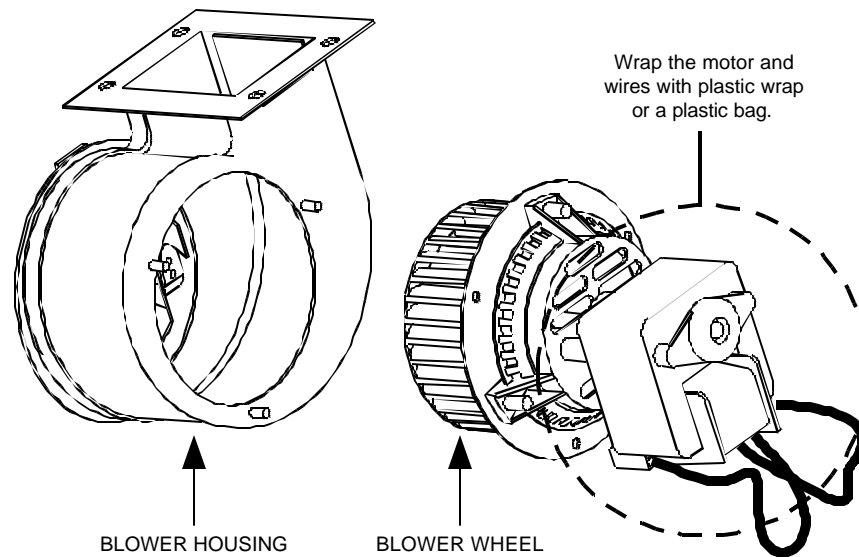

5. Remove the plastic wrap from the blower motor assembly. Reassemble the blower motor assembly and blower housing. Reinstall the blower assembly in the cooker and reconnect the wires disconnected in Step 1.
4. Reinstall the blower shield or shield assembly.
5. Light the cooker in accordance with the procedure described in Chapter 3, Section 3.1.
6. After the burners have been lit for at least 90 seconds, observe the flames through the burner viewing ports. The air/gas mixture is properly adjusted when the burner manifold pressure is in accordance with the applicable table on page 4-4 and the burners display a bright orange-red glow. If a blue flame is observed, or if there are dark spots on a burner face, the air/gas mixture requires adjustment.

On the side of the blower housing opposite the motor is a plate with one or two locking nuts. Loosen the nut(s) enough to allow the plate to be moved, then adjust the position of the plate to open or close the air intake opening until a bright orange-red glow is obtained. Carefully hold the plate in position and tighten the locking nut(s).

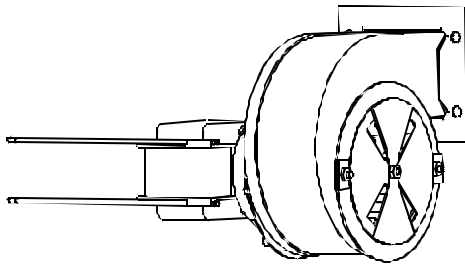

TYPICAL NON-CE BLOWER ASSEMBLY

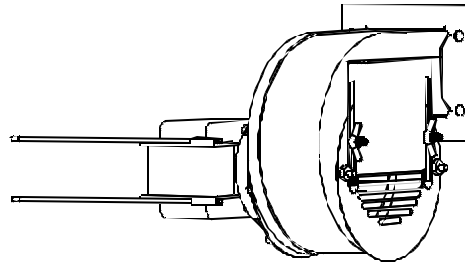

TYPICAL CE BLOWER ASSEMBLY

4.4 Adjusting the Burner Gas Pressure

⚠ DANGER

Frymaster recommends that ONLY qualified service personnel perform this task.

1. On Non-CE cookers, ensure that the gas valve knob is in the **OFF** position.

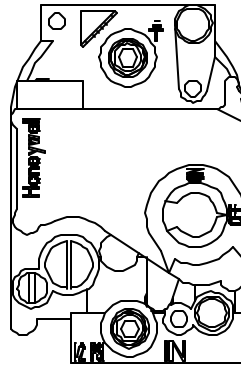

2. Remove the pressure tap plug from the gas valve assembly.

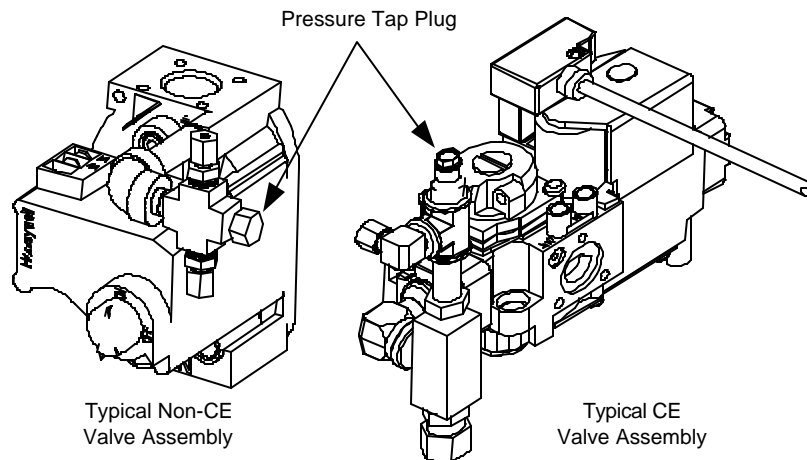

3. Insert the fitting for a gas pressure-measuring device into the pressure tap hole
4. On **NON-CE cookers only**, place the gas valve in the **ON** position.
5. Place the power switch in the ON position. When the burner has lit and burned steadily for at least one minute, compare the gas pressure reading to the pressure for the corresponding gas in the appropriate table below.

CE Standard for Burner Gas Pressure	
Gas	Pressure
Natural Lacq (G20) under 20 mbar	7 mbar
Natural Gronique* (G25) under 25 mbar	12 mbar
Propane (G31) under 37 mbar	22,2 mbar
* Belgian G25 = 7,0 mbar	

Non-CE Standard for Burner Gas Pressure	
Gas	Pressure
Natural	3.5" WC
	0.87 kPa
	8.718 mbar
Propane	8.25" WC
	2.05 kPa
	20.55 mbar

- To adjust the burner gas pressure, remove the cap from the gas valve regulator and use a flat-tipped screwdriver to adjust the regulator to obtain the correct pressure.

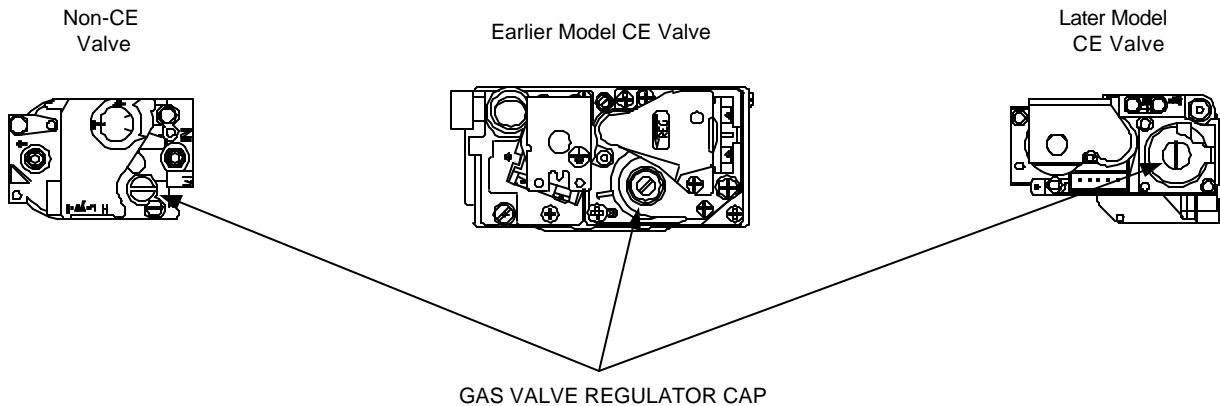

- Place the power switch (and the gas valve in non-CE cookers) in the **OFF** position. Remove the fitting from the pressure tap hole and reinstall the pressure tap plug.



4.5 Measuring Flame Current



When the burner flame is properly adjusted, it will produce a current between 2.5 μA and 3.5 μA . Flame current is measured by placing a microamp (not milliamp) meter in series with the white sensing wire on one of the ignitors. This is accomplished as follows:

- Place the power switch in the **OFF** position.
- Disconnect the sensing wire from one of the burner ignitors and connect it to the positive lead of the meter. Connect the negative lead of the meter to the terminal from which the sensing wire was removed.
- Place the power switch in the **ON** position to light the burners. After the cookpot temperature reaches 200°F (93°C), wait at least one minute before checking the reading. **NOTE:** The closer the unit is to normal operation temperature, the more accurate the reading will be.

4.6 Controller Simmer Mode Adjustment

NOTE: The controller simmer temperature is adjustable from 185°F to 215°F (85°C to 102°C). There are two versions of this controller; one is adjusted by programming, the other is manually adjusted. To

determine which version of the controller you have, turn the controller off by pressing the power  switch. The display will go blank. Press the Simmer Mode  (right thermometer icon) switch. If `CODE` appears in the display, the setpoint is changed via programming; if not, skip to **Manual Adjustment** on the next page.

1. Press 1, 6, 5, 0 to enter the programming mode. The currently programmed simmer setpoint will be displayed. If the setpoint is **not correct**, enter the desired setpoint (for example, press 2, 0, 0 to program the simmer setpoint to 200°).
2. Press the Simmer Mode  switch again to lock the setpoint, then press the power  switch to turn the controller on and return to the normal operating mode.

Manual Adjustment

1. With the unit in the simmer mode, place the tip of a good grade thermometer near the temperature probe and determine the actual water temperature in degrees Fahrenheit. If the temperature is within $\pm 5^{\circ}\text{F}$ (2°C) of the desired simmer temperature, nothing more needs to be done. If it is **not** within $\pm 5^{\circ}\text{F}$ (2°C) of the desired temperature, perform Steps 2 through 5.
2. With the unit in the Simmer Mode, open the control panel by removing the screws in the upper corners and tilting the panel out.
3. Remove the black rubber plug from the top of the controller housing.
4. Using a small, flat-tipped screwdriver, turn the adjusting screw to change the simmer setpoint. A $\frac{1}{4}$ turn will change the setpoint about 10°F (4°C). (You will have to experiment with the direction of rotation to determine which way to turn to raise or lower the temperature). Wait at least 5 minutes, then recheck actual water temperature. Repeat this step until the water temperature is within $\pm 5^{\circ}\text{F}$ (2°C) of desired temperature.
5. Replace the plug in the controller, close the control panel, and replace the screws removed in Step 2.

GAS COOKERS GSMS, GBC, AND GC

INSTALLATION AND OPERATION MANUAL

CHAPTER 5: OPERATOR TROUBLESHOOTING

5.1 Introduction

This chapter provides a reference guide to the more common problems that may occur during the operation of this equipment. The troubleshooting guides in this chapter are intended to help you correct, or at least accurately diagnose, problems with the equipment. Although the chapter covers the most common problems reported, you may very well encounter a problem not covered. In such instances, the Frymaster Technical Service Department will make every effort to help you identify and resolve the problem.

When troubleshooting a problem, always use a process of elimination starting with the simplest solution and working through the most complex. Never overlook the obvious. Anyone can forget to plug a cord into a receptacle or open the valve on the water supply line. Don't assume that you are exempt from such occurrences. Most importantly, try to establish a clear idea of why a problem has occurred. Part of your corrective action involves taking steps to ensure that it doesn't happen again. If a controller malfunctions because of a poor connection, check all other connections while you're at it. If a fuse continues to blow, find out why. Keep in mind that failure of a small component may often be indicative of potential failure or incorrect functioning of a more important component or system.

Some of the troubleshooting actions recommended in this chapter involve removing suspect controllers and substituting controllers that are known to be good. Whenever this is indicated, refer to Section 5.4.

If you have doubts as to the proper action to take, do not hesitate to call the Frymaster Technical Service Department or your local Frymaster Factory Authorized Service Center for assistance.

Before calling a servicer or the Frymaster HOTLINE (1-800-551-8633):

- **Verify that electrical cords are plugged in and that circuit breakers are on.**
- **Verify that water supply valves are open and that the drain valves are fully closed.**
- **Verify that the main gas supply valve is open.**

 **DANGER**

Hot water can cause severe burns. Never attempt to move a cooker containing hot water or to transfer hot water from one container to another.

 **DANGER**

Use extreme care when performing electrical circuit tests. Live circuits will be exposed.

 **DANGER**

Inspection, testing and repair of electrical components should be performed only by qualified service personnel. The equipment should be unplugged when servicing, except when electrical tests are required.

5.2 Operator Troubleshooting Guides

Problem	Probable Causes	Corrective Action
<p>BURNERS DO NOT LIGHT (Main gas supply valve verified to be open, the gas valve in Non-CE units is verified to be ON, and power switch is verified to be ON.)</p>	<p>A. Ignition module lockout (the burners failed to light within 4 seconds).</p> <p>Indicator: Red trouble light on control panel is illuminated.</p>	<p>A. Turn the controller OFF. Open the control panel by removing the screws in the upper corners. If there are two ignition modules, check for blown 2-amp fuses and replace as necessary. Close the control panel and press the power switch. Wait at least 4 minutes.</p>
	<p>B. Dirty water level sensors. (If the computer does not sense sufficient water in the cookpot, it will not allow the burners to fire.)</p>	<p>B. Remove the probe block cover and clean the sensors using a Scotchbrite™ or similar pad and a solution of detergent and water.</p>
	<p>C. Failed controller.</p> <p>Test: If another controller known to be working is available, substitute the working controller for the suspect controller. If the burners light, the controller has failed.</p>	<p>C. Order replacement controller from FASC or distributor.</p>
	<p>D. Failed ignition module or gas valve, or broken or loose wiring.</p>	<p>C. Call FASC.</p>
<p>ON UNIT WITH AUTOFILL, COOKPOT DID NOT FILL WHEN UNIT WAS TURNED ON (Water supply to unit verified to be ON.)</p>	<p>A. Dirty water level sensors. (If the sensors are dirty, they may cause the controller to “think” the cookpot is full.)</p>	<p>A. Remove the probe block cover and clean the sensors using a Scotchbrite™ or similar pad and a solution of detergent and water.</p>
	<p>B. Failed controller.</p> <p>Test: If another controller known to be working is available, substitute the working controller for the suspect controller. If the unit begins to fill, the controller has failed.</p>	<p>B. Order replacement controller from FASC or distributor.</p>
	<p>C. Shorted upper water level sensor, failed water solenoid valve, or loose/broken wiring.</p>	<p>C. Call FASC.</p>

Problem	Probable Causes	Corrective Action
ON UNIT WITH AUTOFILL, WATER DID NOT SHUT OFF WHEN COOKPOT WAS FULL	A. Dirty water level sensors. (If the water level sensors are dirty, the controller may not “know” the pot is full.)	A. Remove the probe block cover and clean the sensors using a Scotchbrite™ or similar pad and a solution of detergent and water.
	B. Insufficient mineral content in water. (Pure water is not a conductor of electricity. The water level sensors actually sense impurities in the water, not the water itself.)	B. Add 1/8-cup of baking soda to the water in the cookpot as the unit fills. <u>DO NOT USE SALT!</u> Doing so will damage the cookpot. Avoid using distilled, highly filtered, or deionized water.
	C. Failed upper water level sensor, loose or broken upper water level sensor wiring, failed water solenoid valve.	C. Call FASC.
AUTOSKIM DOES NOT WORK (AUTOFILL functions correctly.)	A. Failed controller. (If the AUTOFILL functions correctly, the only cause possible is a failed controller.)	A. Order replacement controller from FASC or distributor.
WATER WILL NOT BOIL (Cookpot verified to be full of water with Boil Mode selected, i.e., left indicator is lit and burners are lit.)	A. Failed controller. Test: If another controller known to be working is available, substitute the working controller for the suspect controller. If the unit begins to fill, the controller has failed.	A. Order replacement controller from FASC or distributor.
	B. Failed temperature probe.	B. Call FASC.
WATER BOILS IN SIMMER MODE	A. Controller out of adjustment.	A. Adjust controller in accordance with procedure in Chapter 4.
	B. Failed controller. Test: If another controller known to be working is available, substitute the working controller for the suspect controller. If the unit begins to fill, the controller has failed.	B. Order replacement controller from FASC or distributor.
	B. Failed/shorted temperature probe.	C. Call FASC.

Problem	Probable Causes	Corrective Action
WATER TEMPERATURE IS TOO LOW IN SIMMER MODE	A. Controller out of adjustment.	A. Adjust controller in accordance with procedure in Chapter 4.
	B. Failed controller. Test: If another controller known to be working is available, substitute the working controller for the suspect controller. If the unit begins to fill, the controller has failed.	B. Order replacement controller from FASC or distributor.
	C. Open temperature probe or loose probe wire.	C. Call FASC.
BASKET LIFT MOVEMENT IS JERKY OR NOISY	A. Lack of lubrication on basket lift rods.	A. Lubricate lifter rods with a lightweight lubricant.

5.3 Wiring Diagram

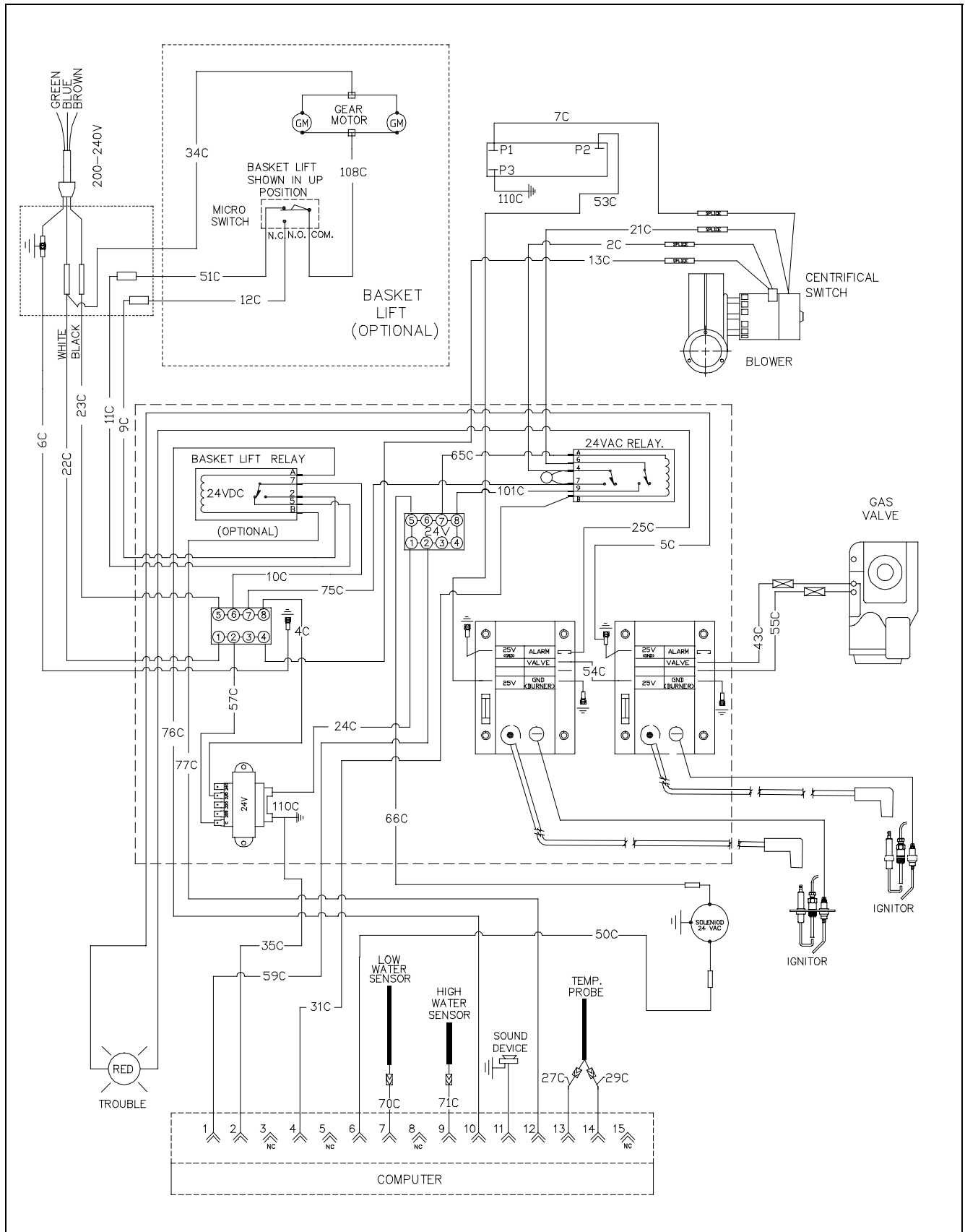

5.4 Replacing the Controller

1. Disconnect the cooker from the electrical supply.
2. Remove the two screws in the upper corners of the control panel and swing the panel open from the top, allowing it to rest on its hinge tabs.
3. Disconnect the wiring harness from the back of the controller.
4. Disconnect the ground wire from the controller. Remove the control panel by lifting it from the hinge slots in the frame.
5. Follow the instructions that came with the replacement controller to dismount the failed controller from the control panel and install the new controller.
6. Reverse Steps 1 through 4 to complete the procedure.

THIS PAGE INTENTIONALLY LEFT BLANK



Frymaster, L.L.C., 8700 Line Avenue, PO Box 51000, Shreveport, Louisiana 71135-1000
Shipping Address: 8700 Line Avenue, Shreveport, Louisiana 71106

TEL 1-318-865-1711

FAX (Parts) 1-318-219-7140

(Tech Support) 1-318-219-7135

PRINTED IN THE UNITED STATES

SERVICE HOTLINE
1-800-551-8633

819-5311
NOVEMBER 2001