

Digital Copier

Operating Instructions (For Copier)

Model No.

DP-150FP

Options

DA-DS150

DA-SM16B

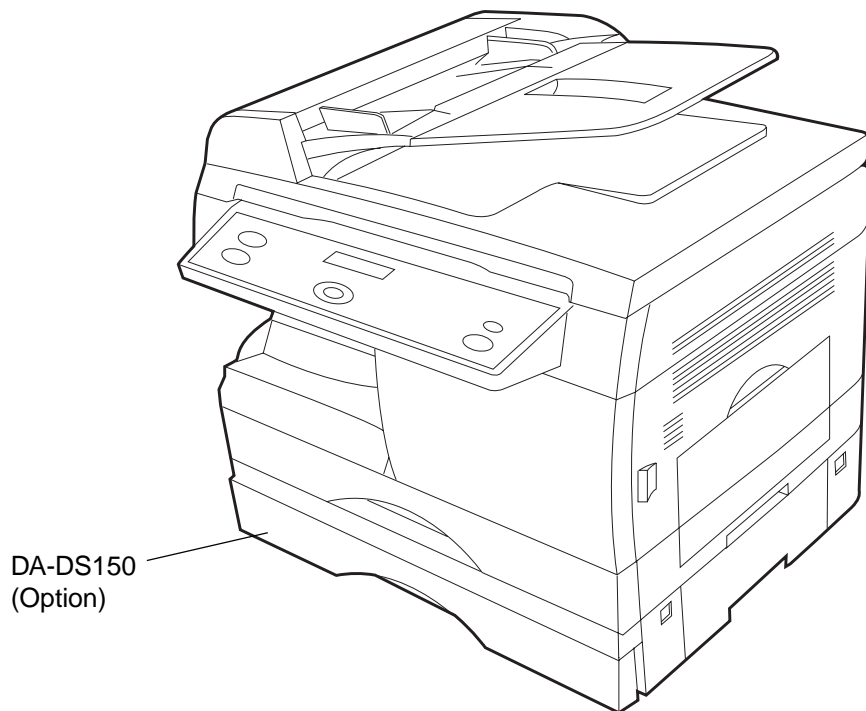

Before operating this copier, please read these instructions completely and keep these operating instructions for future reference.

English

4

Operation Chart

Common features

Full Size Copying 100%

Automatic Document Feeder

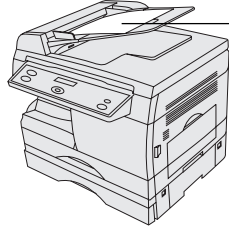

Turn the Power Switch ON.
(See page 9)
Load the paper
(See page 21)

Control Panel

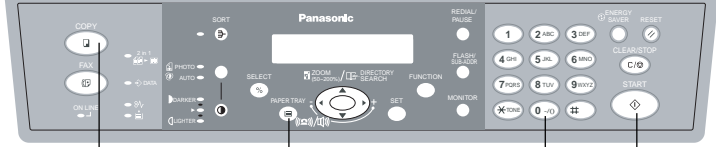

1

Position original

- Face-Up
- Up to 30 originals (80 g/m²), size: A5 - B4-FLS

2

Press the Copy Key

(3)

Select paper tray

4

Number of copies (Up to 99)

5

Press Start

How to copy without using ADF (Automatic Document Feeder).

Position of the original

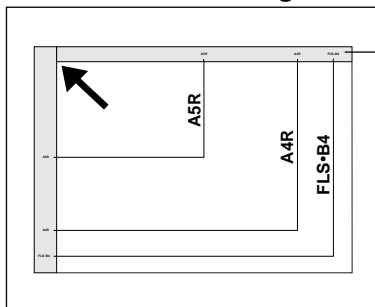

Original Guide

Place original against guide.

- Face DOWN on platen.
- If the original is incorrectly placed on the platen glass, part of the copy image may be missing.

When manually selecting exposure control:

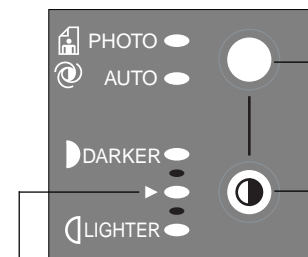

Normal Position

- The copier has auto exposure control and adjustments are rarely required.

Select Photo to copy photos and halftones.
Select Auto to copy with Auto exposure control.

Select Dark to copy light image originals.
Select Light to copy colored background originals.

NOTE

Inappropriate originals

- Paper with a smooth surface such as glossy and coated papers
- Transparencies
- Paste-ups
- Originals with a lead edge that is creased, folded, punched or glued
- Pressure sensitive paper or paper with carbon backing
- Paper with excessive curl
- Stapled originals
- Originals with oil on them
- Remove stacked copies from the exit tray every 200 sheets.

Overview

Useful for office, more than 4 functions

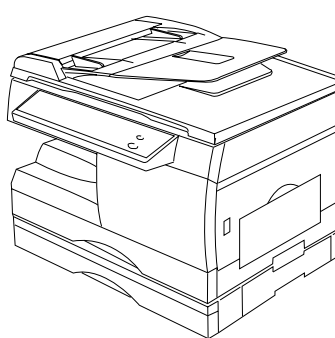

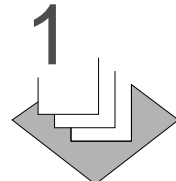
1  **Copier**

- Can copy up to B4 size.
- Available to copy text/photos/halftones originals.

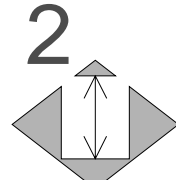
2  **Facsimile**

- Plain paper Super G3 compatible Fax.
- Available duplex printing of received Faxes. Can be used as a regular telephone with optional handset.

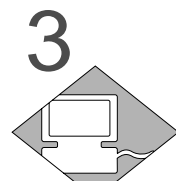
3  **Printer**

- Digital printer controller standard, printer resolution 300 dpi.

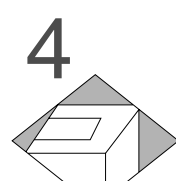
4  **Scanner**

- Black & White original scanner standard, scan resolution 400 dpi.

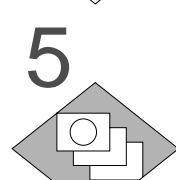
5  **Application Software**

- Document Manager
- Document Viewer
- Document Scanner
- Utilities (Status Monitor, Phone Book Editor, Device Configuration Editor)

DP-150FP Operating Instructions (Manual Overview)

This copier includes 3 operating instruction manuals, please use the correct manual when operator intervention is necessary.

<Copier>

Use the information provided in this manual whenever a copier function requires intervention. For example: how to make copies, add paper, replace the toner cartridge, etc..

<2nd bin for C>

Use the information provided in the DP-150FP Facimile Operating Instructions manual whenever a fax function requires intervention. For example: how to send/receive a fax, or when a trouble message appears, etc..

<Printer>

&

<Other Advanced Functions>

Use the information provided on the enclosed CD for an explanation of how to use as a Printer, Scanner, Phone Book Editor, Device Settings, Status Monitor, and/or Document Management System.

Energy Star



The FP-150FP series copiers comply with Tier 2 of the Environmental Protection Agency's Energy Star Program. This voluntary program specifies certain energy consumption and usage standards for copiers. These copiers will automatically "power down" after a specified period of non-use. The use of these Energy Star compliant copiers will reduce energy consumption and ultimately benefit the environment.

The default functions can be adjusted depending on your office requirements. Please see your authorised Panasonic copier dealer for more details.

Table of Contents

Before Operation

Overview	3
Precautions	6
Components	
■ External/Internal	9
■ Control Panel	10
Mode Functions	12
Features	13

Making Copies

Common features	
■ Full Size Copying	2
■ Reduction or Enlargement Copying	14
■ Zoom Copying	15
Creative Features	
■ Digital skyshot	16
■ 2 in 1 Copy	17
■ Sorting	18
■ Using the Sheet Bypass	19

Option

Option	20
--------------	----

Maintenance

Handling	
■ Adding Paper	21
■ Changing paper size	22
■ Changing Toner Cartridge	23
■ Changing Drum Unit	24
■ Removing a Paper Misfeed (Main Unit)	25
■ Removing an Original Misfeed (ADF)	27
■ Removing a Misfed Paper (2nd Paper Feed Module)	28
Checking	
■ Troubleshooting	29

Others

Specifications	32
Consumables List	33

Precautions

For your safety

■ Laser Safety

LASER SAFETY

This unit employs a laser. Only qualified service personnel should attempt to service this device due to possible eye injury.

Caution

This product utilizes a laser.

Use of controls or adjustments or performance of procedures other than those specified herein may result in hazardous radiation exposure.

LASER KLASSE 1
LASER CLASSE 1
RANGO LASER 1
CLASS 1 LASER PRODUCT
(TO IEC 825)

■ Caution Labels

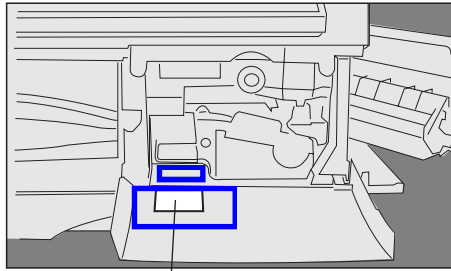

ATTENTION:
Rayonnement laser invisible
dangereux en cas d'ouverture et
lorsque la sécurité est neutralisée.
EXPOSITION DANGEREUSE AU FAISCEAU.

CAUTION:
Invisible laser radiation when
open and interlocks defeated.
AVOID EXPOSURE TO BEAM.

PELIGRO:
Cuando se abre y se invalida el bloqueo, se
producen radiaciones invisibles de láser.
EVITESE LA EXPOSICIÓN
DIRECTA A TALES RAYOS.

VORSICHT:
Unsichtbare Laserstrahlung, wenn
Abdeckung geöffnet und
Sicherheitsverriegelung überbrückt.
NICHT DEM STRAHL AUSSETZEN.

FFPTE2584

Handling

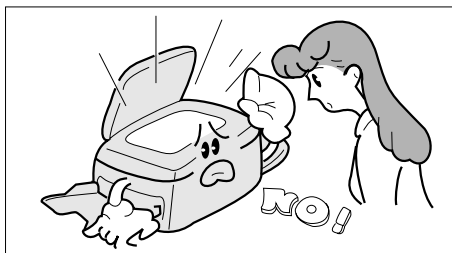

- Do not look directly at exposure lamp when copying.
- Do not turn the power switch off or open the front panel during copying. (See page 9)
- Do not drop paper clips or other metal objects into the copier.

Toner and Paper

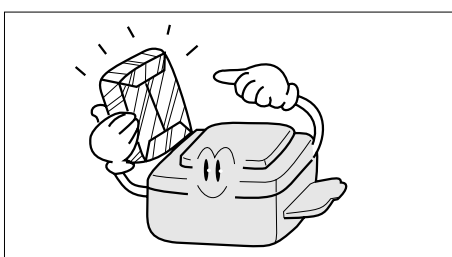

- Store toner, developer and paper in cool areas with low humidity.
- High quality paper of 60 – 90 g/m² (55 – 130 g/m² via sheet bypass) may be used.
- For optimum copy quality, it is essential that Panasonic Brand Toner is used in the copier.

Installation

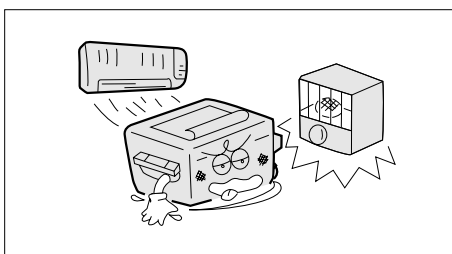

- The copier should not be installed in areas with the following conditions:
 - Extremely high or low temperature and humidity. Ambient Conditions Temperature: 10°C – 30°C Relative humidity: 30% – 80%
 - Where temperature and humidity can change rapidly, causing condensation.
 - Direct exposure to sunlight.
 - Directly in air conditioning flow.
 - In areas of high dust concentration.
 - In areas of poor ventilation.
 - In areas with chemical fume concentration.
 - In areas with extreme vibration.
 - Unstable or uneven floors.



Precautions

Ventilation

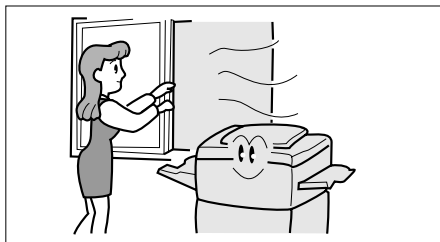

- The copier should be installed in a well-ventilated area to minimize the ozone density in the air.

FOR YOUR SAFETY



Caution Note: Disconnect from the mains supply before removing covers.

The mains plug on this equipment must be used to disconnect mains power. Please ensure that the socket outlet is installed near the equipment and shall be easily accessible.

For U.K.

This appliance is supplied with a moulded three pin mains plug for your safety and convenience. A 13 amp fuse is fitted in this plug.

Should the fuse need to be replaced please ensure that the replacement fuse has a rating of 13 amps and that it is approved by ASTA or BSI to BS1362

Check for the ASTA mark  or the BSI mark  on the body of the fuse.

If the plug contains a removable fuse cover you must ensure that it is refitted when the fuse is replaced.

If you lose the fuse cover the plug must not be used until a replacement cover is obtained.

A replacement fuse cover can be purchased from your local Panasonic Dealer.

IF THE FITTED MOULDED PLUG IS UNSUITABLE FOR THE SOCKET OUTLET IN YOUR OFFICE THEN THE FUSE SHOULD BE REMOVED AND THE PLUG CUT OFF AND DISPOSED OF SAFELY.

THERE IS A DANGER OF SEVERE ELECTRICAL SHOCK IF THE CUT OFF PLUG IS INSERTED INTO ANY 13 AMP SOCKET.

If a new plug is to be fitted please observe the wiring code as shown below.

If in any doubt please consult a qualified electrician.

WARNING: THIS APPLIANCE MUST BE EARTHED.

IMPORTANT: The wires in this mains lead are coloured in accordance with the following code:

Green and Yellow: Earth

Blue : Neutral

Brown : Live

As the colours of the wires in the main lead of this appliance may not correspond with the coloured markings identifying the terminals in your plug, proceed as follows:

The wire which is coloured GREEN-AND-YELLOW must be connected to the terminal in the plug which is marked by letter E or by the safety Earth symbol "" or coloured GREEN or GREEN-AND-YELLOW.

The wire which is coloured BLUE must be connected to the terminal in the plug which is marked with the letter N or coloured BLACK.

The wire which is coloured BROWN must be connected to the terminal in the plug which is marked with the letter L or coloured RED.

How to replace the fuse.

Open the fuse compartment with a screwdriver and replace the fuse.

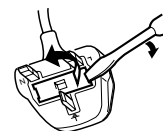

Components

Using the Sheet Bypass

External

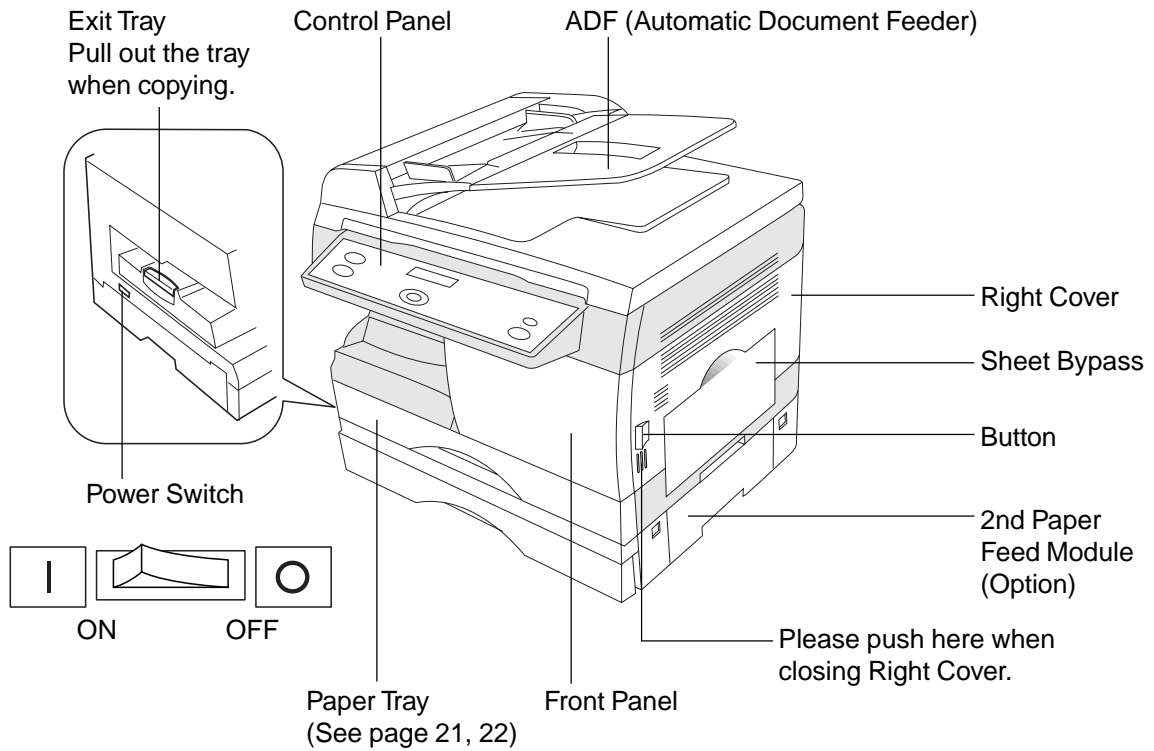

Internal

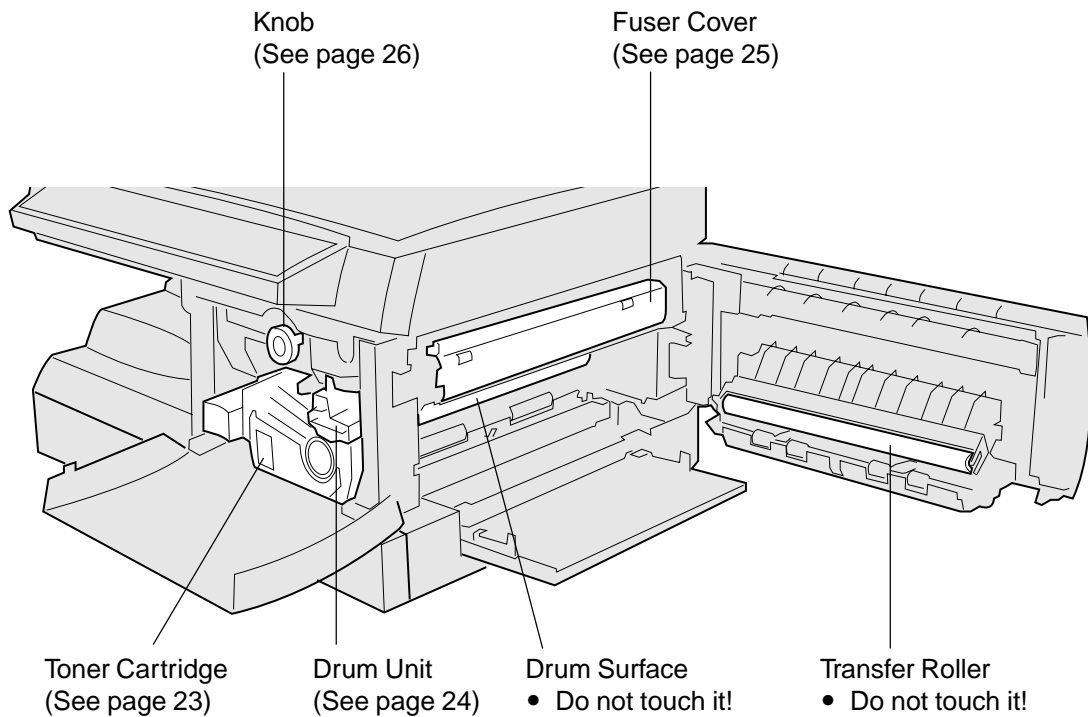

Components

Control Panel

- **Function keys for making copies.**
(Function keys for fax, please see fax instruction.)

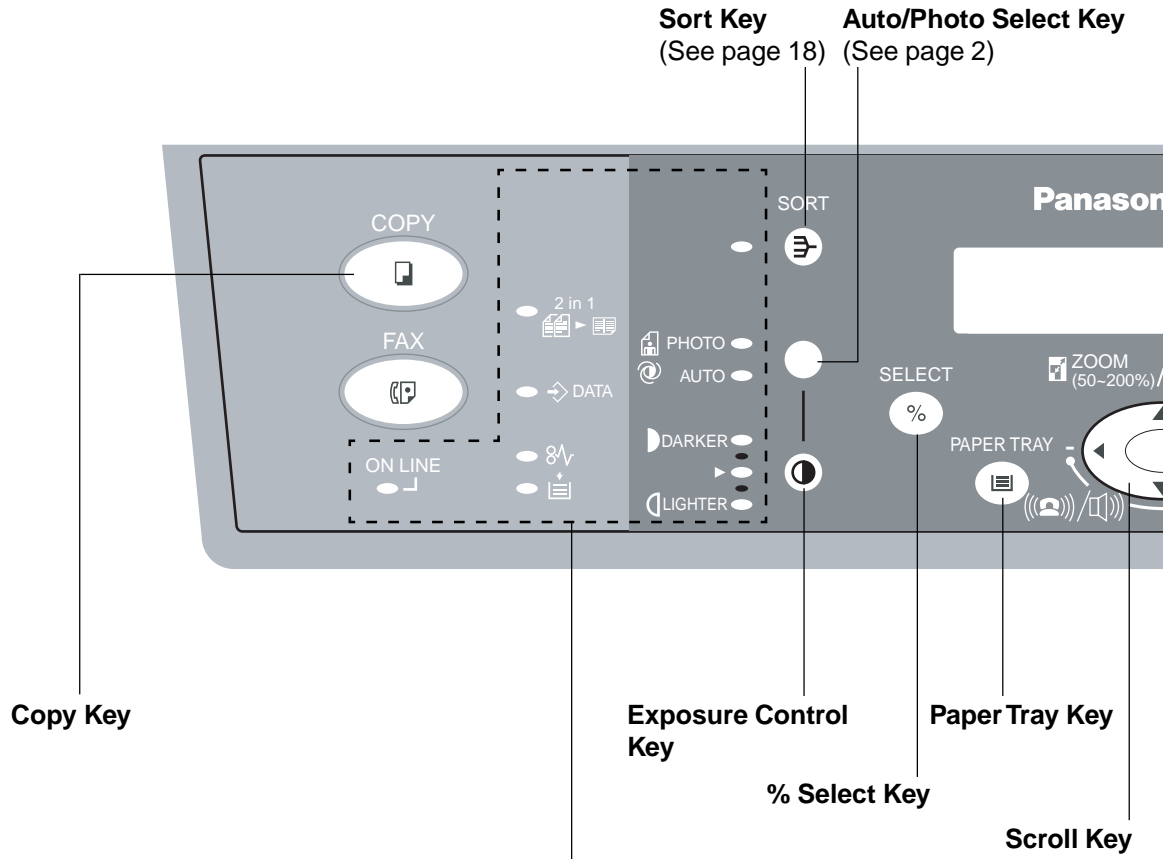

Note: Please check any pages referring to this key that key is called Scroll Key; and just explain function of top, bottom, left, and/or right button.

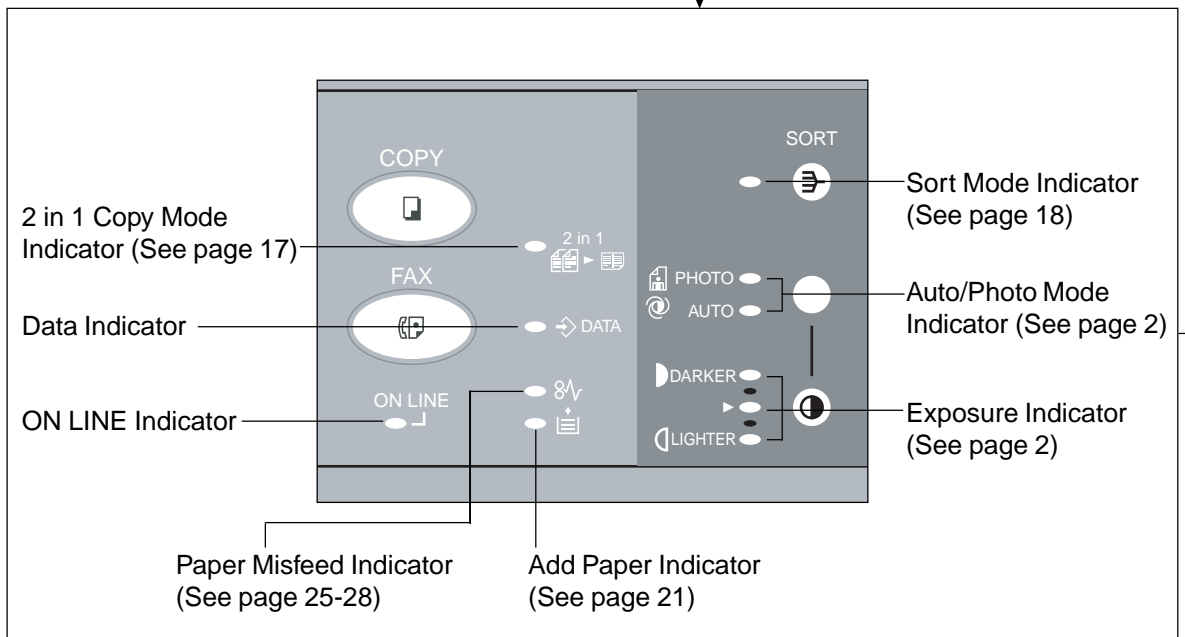

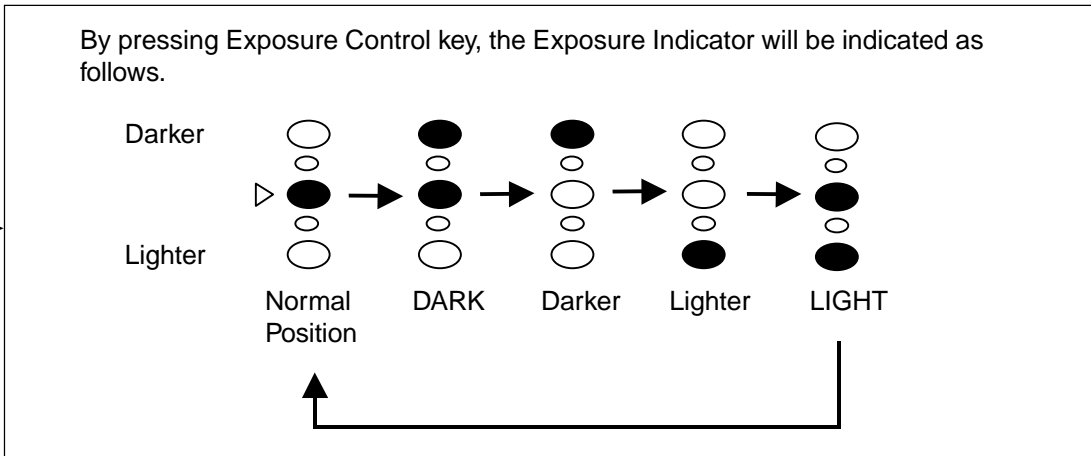
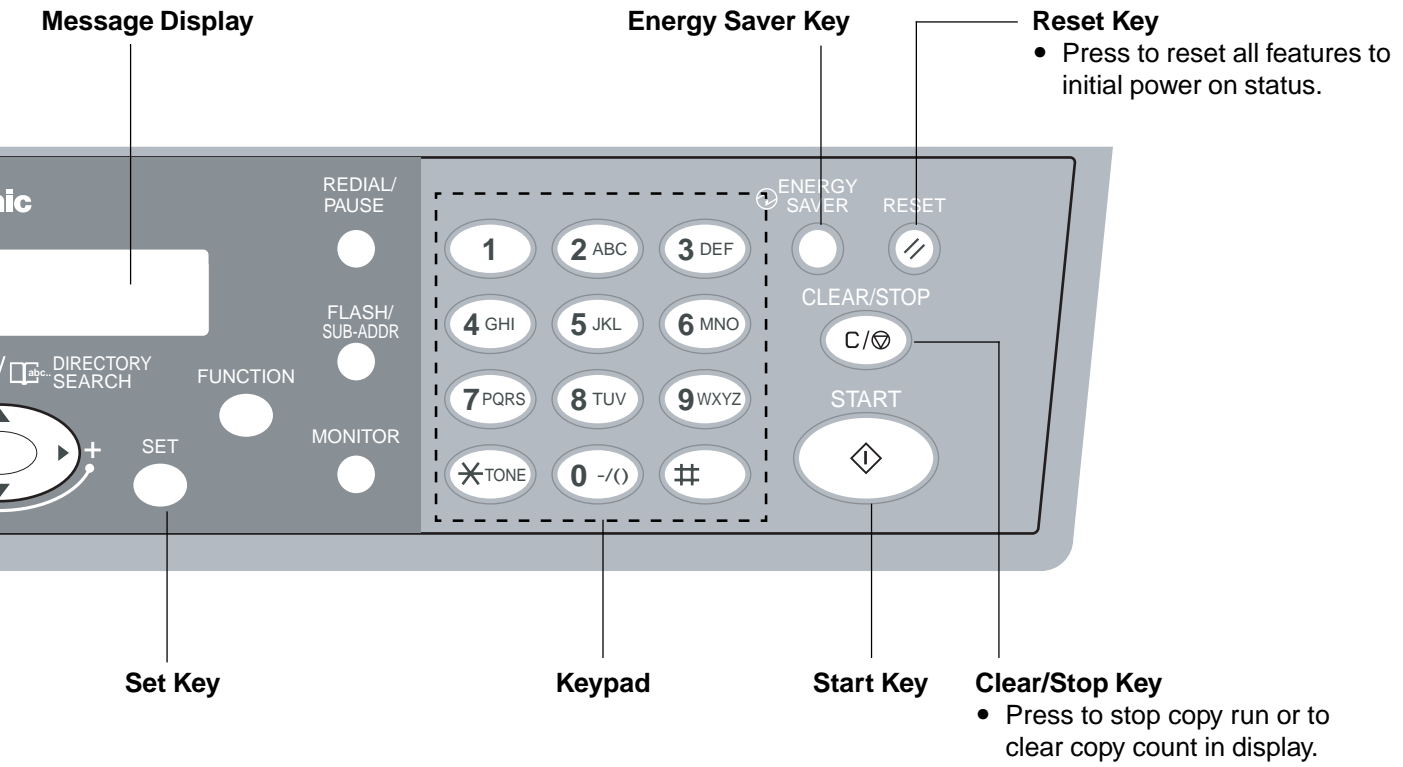

Mode Functions

■ Energy Saver Mode/Auto Off Mode

Energy Saver Mode

- ① To enter this mode
Press Energy Saver key. The indicator will flash.
Automatically activates after 15 minutes from the last copy.
- ② To cancel this mode
Press Energy Saver key again.

Auto Off Mode

- ① Automatically activates after 30 minutes from the last copy.
Power consumption will drop and the Energy Saver key indicator will light.
- ② To cancel this mode.
Press Energy Saver key.

If you wish to change the above settings or if you need more information, call your Panasonic authorised dealer.

	Power Consumption	Warm Up Time
Normal Operation	Approximately 60 Wh	None
Energy Saver Mode	Approximately 35 W	5 seconds
Auto Off Mode	Approximately 1.5 W	25 seconds

■ Toner Saver Mode

- 1) This only works when using copy mode. When printing out by Printer or Fax function, this mode does not work.
- 2) The Toner Saving Mode is to save toner consumption by copying dark originals lighter. The exposure indicator "LIGHT" flashes when Toner Saving Mode is on.

- 3) To enter this mode:

- ① Press Copy Key
- ② Press Function Key
- ③ Press "4" key of Keypad
- ④ Press **Set** Key.
- ⑤ Select "TONER SAVER 2:VALID".
Press "2" key of Keypad
- ⑥ Press **Set** Key.

To cancel this mode:

- ① Press Copy Key
- ② Press Function Key
- ③ Press "4" key of Keypad
- ④ Press **Set** Key
- ⑤ Select "TONER SAVER 1:INVALID".
Press "1" key of Keypad
- ⑥ Press **Set** Key.

■ Copy Reservation Function

While the copier is warming up, you may position your original on the copier, enter your copy job selections and press the Start key. The Wait indicator (Start key) will flash until the warm up cycle is completed and the copy job will automatically start.

Note: Please enter your copy job, when "WARM UP, PLEASE WAIT SELECT COPY JOB" appears in message display.

Features

■ Features List

Reduction or Enlargement Copying	(See page 14)	Copying with preset ratios.
Zoom Copying	(See page 15)	Copying with variable zoom ratios.
Digital skyshot	(See page 16)	Copying from small originals without dark areas around the image.
2 in 1 copy	(See page 17)	Copying from two 1-sided originals, side by side, to 1-sided copies.
Sorting	(See page 18)	Multiple copies to be sorted automatically.

Common features

Reduction or Enlargement Copying

■ There are 3 preset reduction and 1 preset enlargement modes.

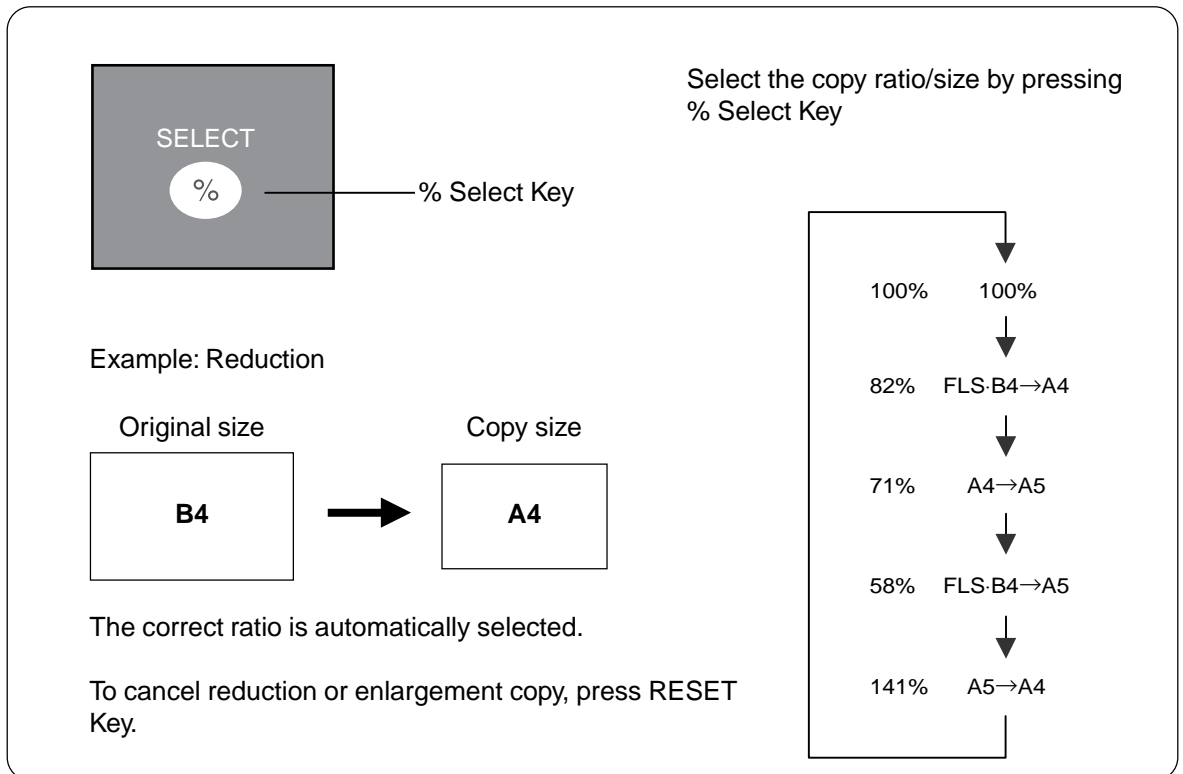
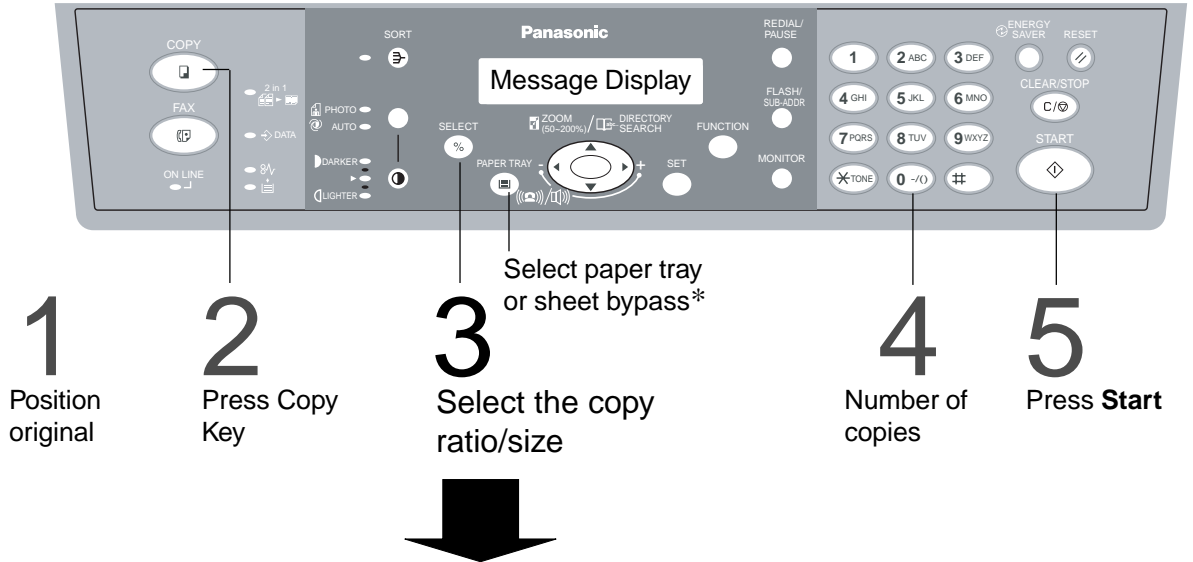

NOTE

- * When copy size is different from paper size of paper tray, select sheet bypass by pressing Paper Tray key and place the paper into the sheet bypass. (See page 19)
- To change the paper size of the paper tray, see page 22.

Zoom Copying

- A zoom ratio can be selected from 50% to 200% in 1% increments.

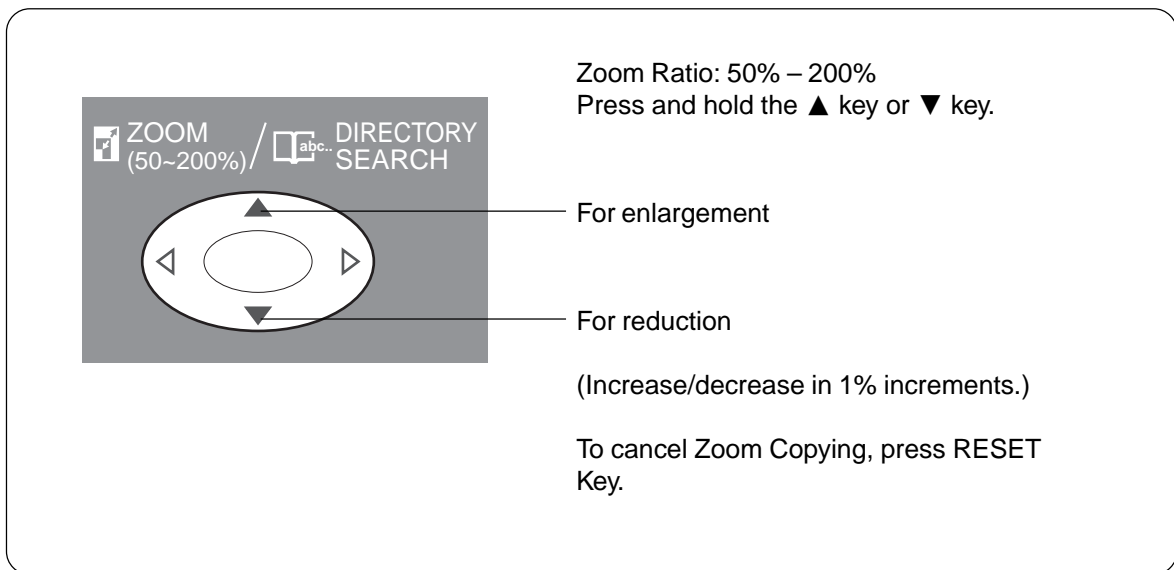
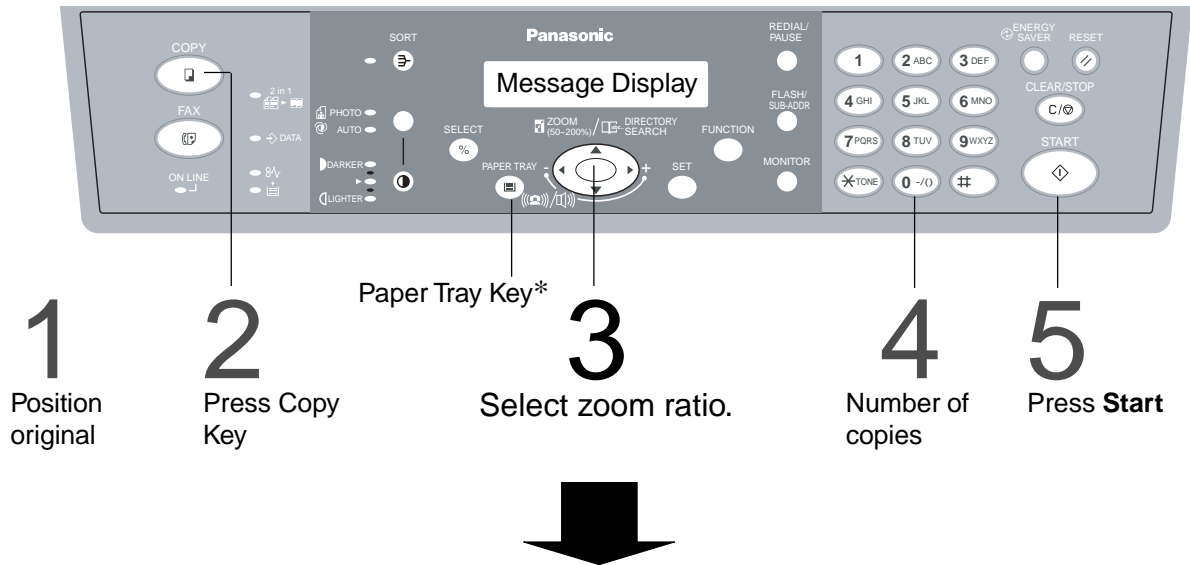

NOTE

- * When copy size is different from paper size of paper tray, select sheet bypass by pressing Paper Tray key and place the paper into the sheet bypass. (See page 19)
- To change the paper size of the paper tray, see page 24.

Creative Features

Digital skyshot

- To copy from the platen with ADF open. Making copies from small originals without dark areas around the image. The Digital Skyshot mode is normally set on. If the mode is not set, please use the following procedure.

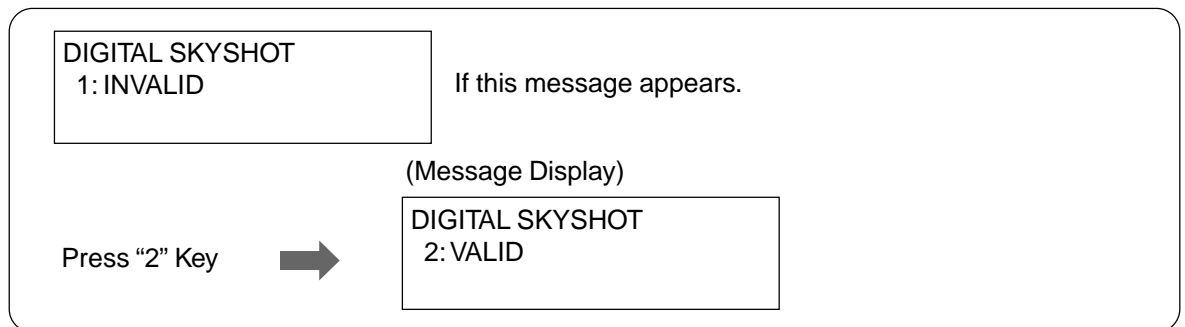
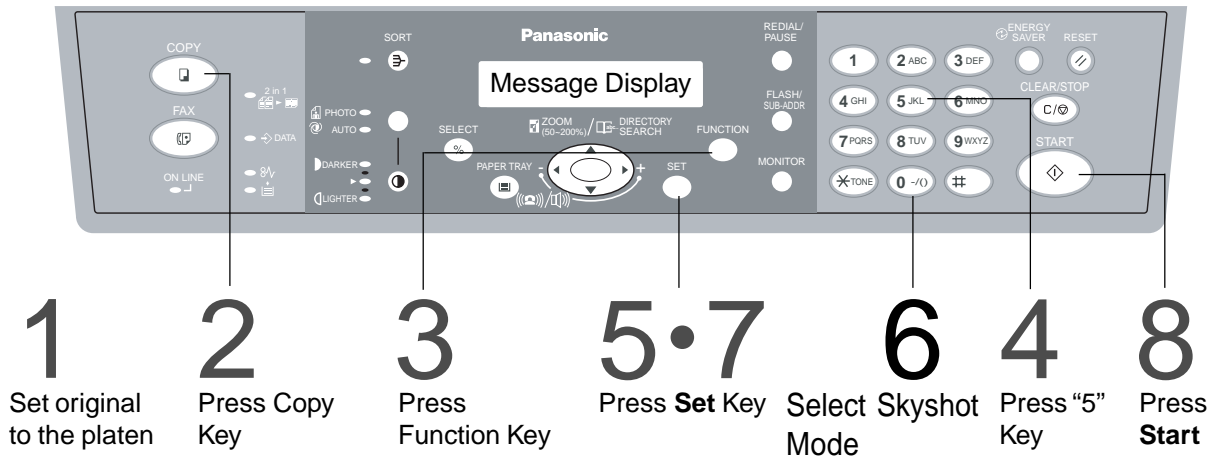

NOTE

- Incorrect output may occur if the copier cannot properly detect the edges of the original.
- Incorrect output may occur if the copier is directly under and/or near an extremely bright light source.
- If the ADF(Automatic Document Feeder) is closed, the Digital Skyshot mode will not operate.
To turn this mode off, use the procedure above (6).

2 in 1 Copy

■ For 2 in 1 copying.

1 Set originals in ADF tray

2 Press Copy Key

3 Select 2 in 1 Mode

4 Number of copies

5 Press Start

How to set original to ADF

Face-Up

Press ► key to select the 2 Sided Copy mode

1 time 2 in 1 mode ON

2 times 2 in 1 mode OFF

% Select Key

◀ key

▶ key

• When copying the 2 in 1 mode from A5 to A4 or from B4-FLS to A4, select the preset copy ratio with the % Select Key.

ATTENTION

- When copy size is different from paper size of paper tray, select sheet bypass by pressing Paper Tray key and place the paper into the sheet bypass. (See page 19)
- To change the paper size of the paper tray, see page 22.
- 2 in 1 will not work off the platen glass.
- When copying the 2 in 1 mode with A5 size, copy image will be missing.

Creative Features

Sorting

Multiple copies to be sorted automatically.

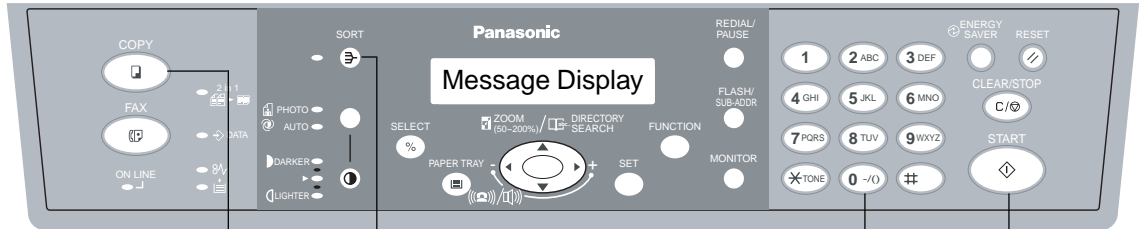

When using ADF

- 1 Set originals in ADF tray
- 2 Press Copy Key
- 3 Press Sort Key
 - The indicator flashes
- 4 Number of copies
- 5 Press Start

When setting original to the platen

- 1 Set original to the platen
- 2 Press Copy Key
- 3 Press Sort Key
 - The indicator flashes
- 4 Number of copies
- 5 Press Start
- 6 When the copy of the first original is finished, set the next original
- 7 Press Start
- 8 Continue procedure 6 and 7 until the last original copying is finished. Then press Sort Key.
 - The indicator flashes
- 9 Press Start Copying from the 2nd set will start.

Sorting is.

Example: Copying 3 set from 3 originals.

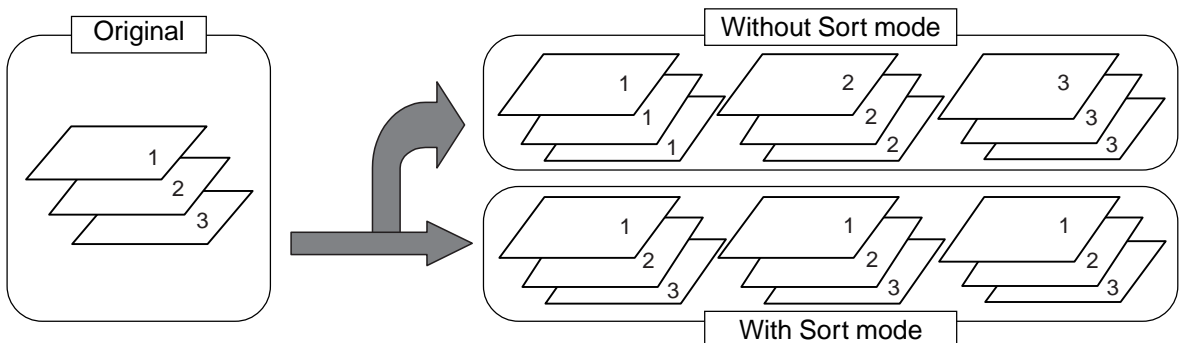

With Sort mode, copies will be sorted as the same order of the original.

ATTENTION

- Do not press Sort Key when number of copy is one.
- ADF's(Automatic Document Feeder) scanning may stop in some cases when the memory capacity has overflowed. This may occur especially when scanning halftone originals. In this case, return from the original which did not scan and re-start scanning. Follow the procedures indicated in the display.

Using the Sheet Bypass

- To copy on letterhead, mailing labels, transparencies and odd-size paper, etc., or to use bypass as an additional paper source.

1

Position original
Select copy ratio/size.
(See page 14)

2

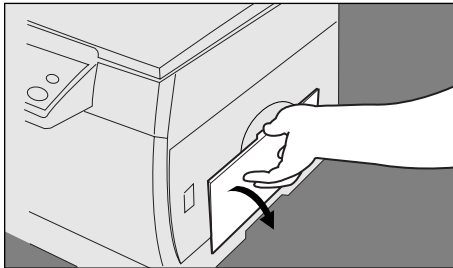

Open the Sheet Bypass.

3

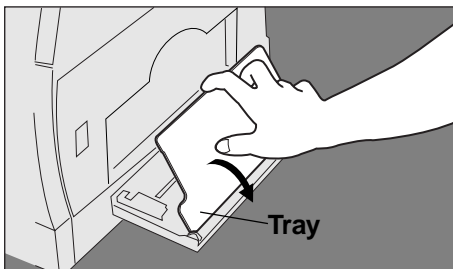

Open the tray.

4

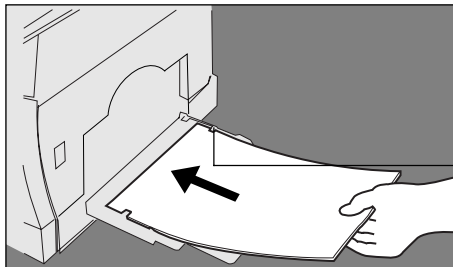

- ① Place paper into the tray. (Up to 50 sheets)
Insert the paper until it stops.

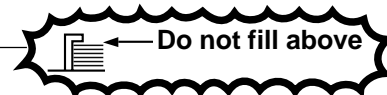

Copy side down for copying on letterhead paper and mailing labels.

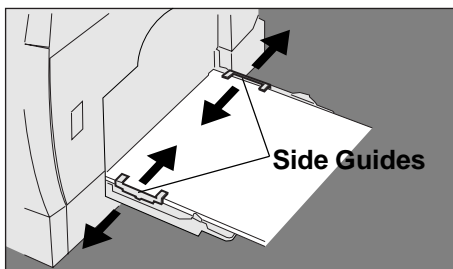

- ② Adjust the side guides to paper width.
Incorrect adjustment may cause paper to wrinkle, misfeed or skew.

5

Select sheet bypass with Paper Tray key.

NOTE

- When using double sided copies, do not set more than 25 (80 g/m²) sheets in bypass.
- Some types of mailing labels and transparency film may damage your machine. Contact your service provider for advice regarding non-standard paper types.

Option

Option

■ 2nd Paper Feed Module (DA-DS150)

Available to add 250-sheet paper tray.

- For installation, see the Installation Instructions provided.
- For setting and changing paper size, see page 22.

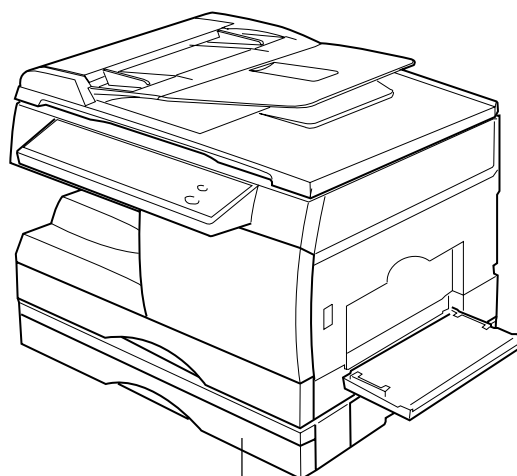

2nd Paper Feed Module
(DA-DS150)

The illustration is the main unit with optional 2nd Paper Feed Module.

Handling

Adding Paper

■ Use the following steps to add paper.

1

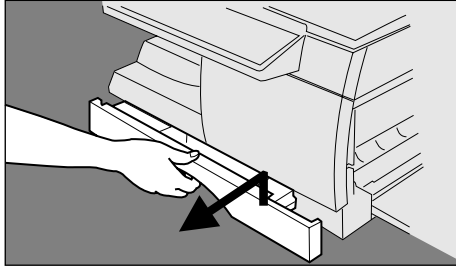

Lift paper tray and pull out of the copier until it stops.

2

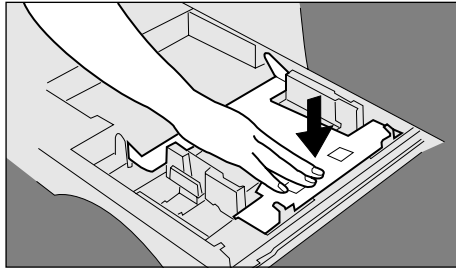

Push the bottom plate down until it locks.

3

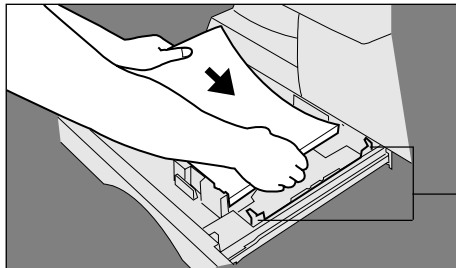

Place paper into the tray.

How to place paper:
Place the paper copy side up.



4

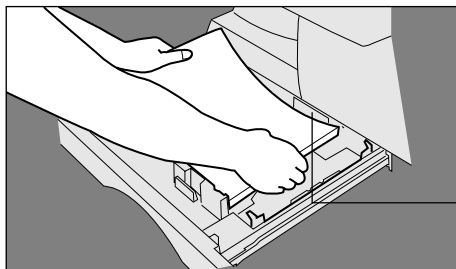

Make sure paper is not loaded above overfill indicator located in the paper tray.

Overfill Indicator

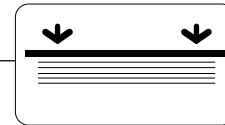

← Single sided copy

5

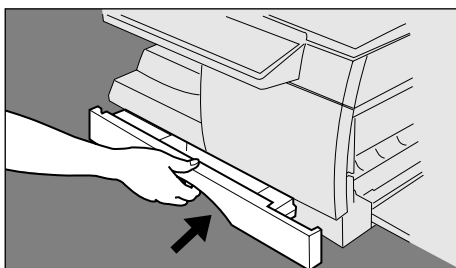

Push paper tray back into copier.

NOTE

- Special papers, like glossy paper, mailing labels and transparencies cannot be used in the paper tray. Use bypass for special paper.
- When making double sided copies, use the sheet bypass.
- If the paper tray is not closed completely, the Add Paper Indicator in the control panel will light up. In that case, please close the paper tray completely.

Handling

Changing paper size

- Following is the procedure to change paper size of paper tray from the control panel. This procedure is also same for optional 2nd Paper Feed Module.

1 Press Copy Key

2 Press Function Key

4·6·8 Press Set Key

3·5·7

9·10

3 Press "3" Key → 3: PAPER SIZE ? PRESS SET TO SELECT appears in the message display.

5 Press "1" or "2" Key → Press "1" to select standard 250-sheet paper tray
Press "2" to select optional 2nd Paper Feed Module*1

7 Select paper size by Keypad →

1: A4	4: FLS (8" × 13")	7: LEGAL
2: B5	5: FLS (8.5" × 13")	8: INVOICE
3: A5	6: LETTER	0: NOT INSTALLED*2

- After changing paper size from the control panel, change the paper size of paper tray by following procedure.

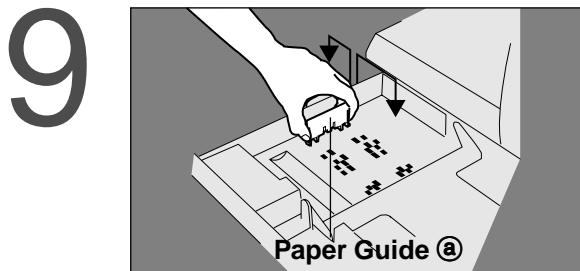

- ① Lift paper tray and pull out of the copier until it stops.
- ② Move paper guide (a) to the paper length required.

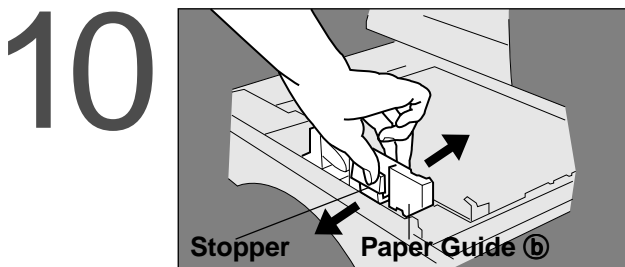

- ① Move paper guide (b) to the paper width required.
Squeeze the stopper to move the paper guide (b) to the desired paper size.
- ② Push paper tray back into copier.

ATTENTION

- Please change the paper size of 2nd Paper Feed Module by same procedure.
- *1 When the optional 2nd Paper Feed Module is not installed, set to "TRAY 2, to zero (0) not installed".
- *2 "TRAY 2 0: NOT INSTALLED" is available to select only when optional 2nd Paper Feed Module is selected at the procedure 5.

Changing Toner Cartridge

■ Message will appear in the message display when needs to add toner.

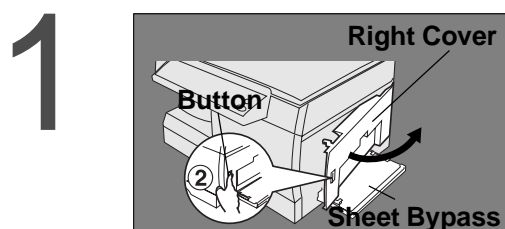

- ① Open the sheet bypass.
- ② Push the button.
- ③ Open the right cover.

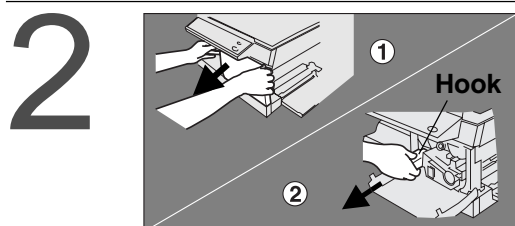

- ① Open the front panel.
The front panel can not be opened until the right cover is open. See procedure 1.
- ② Pull the green hook of toner cartridge.

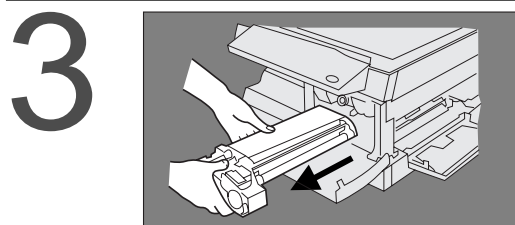

Remove the toner cartridge.

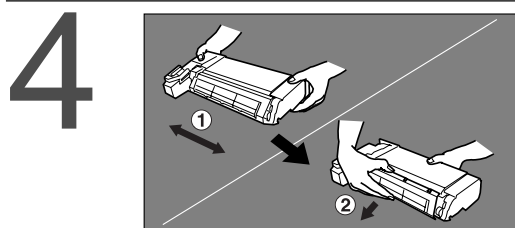

- ① Shake the new toner cartridge several times.
- ② Take off the new toner cartridge cover (white plastic) and discard.

Do not stand the toner cartridge on end!

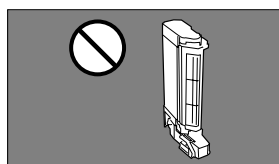

Do not touch the magnetic roller!

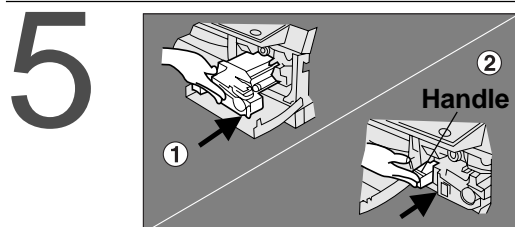
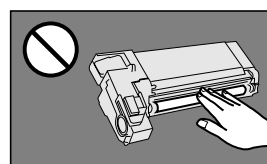

- ① Install new toner cartridge.
- ② Push the green handle until it locks.
- ③ Close the front panel.
- ④ Close the right cover. (See page 9)
- ⑤ Close the sheet bypass.

ATTENTION

- For optimum copy quality use the recommended Panasonic toner cartridge. Store toner cartridge in a cool dark place. Install toner cartridge immediately after unsealing.

Handling

Changing Drum Unit

- Message will appear in the message display when needs to change drum unit.

1

- ① Open the sheet bypass.
- ② Push the button and open the right cover.
- ③ Open the front panel.
- ④ Remove the toner cartridge.

For detail procedure, see page 23.
(Procedure 1 to 3)

2

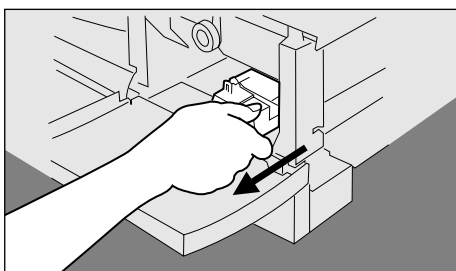

Remove the drum unit by pulling the handle with green label.

3

Take out the new drum unit from the plastic bag.

4

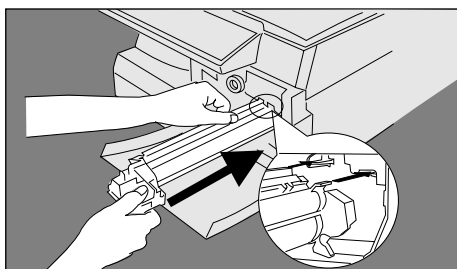

Replace new drum unit by aligning the arrows on the drum unit with those of the copier.

5

- ① Replace the toner cartridge.
(See page 23)
- ② Close the front panel.
- ③ Close the right cover.
(See page 9)
- ④ Close the sheet bypass.

ATTENTION

- For optimum copy quality use the recommended Panasonic drum unit. Store drum unit in a cool dark place. Do not unseal drum unit before use. Use it as fast as possible after unsealing.
- Do not touch or scratch the surface of the drum.

Removing a Paper Misfeed (Main Unit)

■ Paper transport and paper entry areas

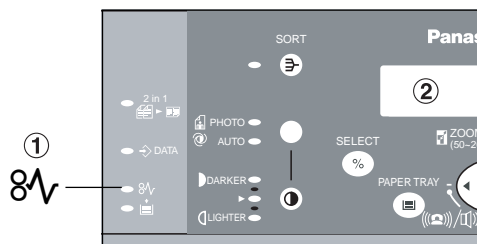

When an original misfeed has occurred

- ① Paper Misfeed Indicator will light.
- ② Paper misfeed message will appear in the message display.

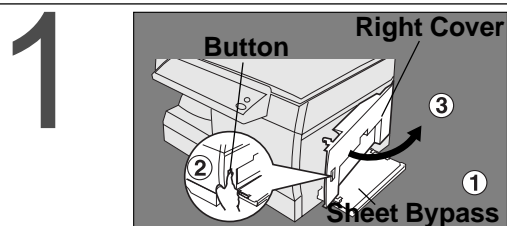

- ① Open the Sheet Bypass.
- ② Push the button.
- ③ Open the right cover.

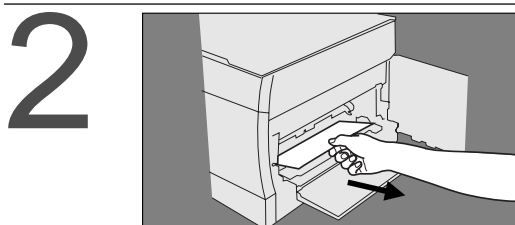

Remove the misfed paper.

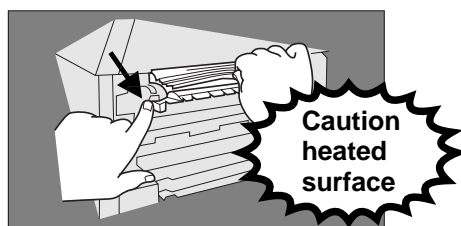

In case the jam is in fuser unit:

- ① Open the fuser cover.
- ② Remove misfed paper.

Caution: This fuser area will be hot.

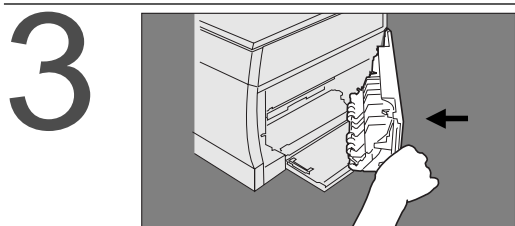

Close the right cover.

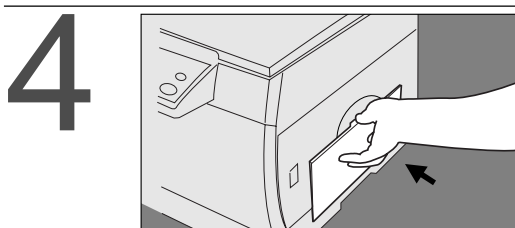

Close the sheet bypass.

ATTENTION

- Make sure that the misfeed indicator goes off after removing a paper misfeed. The misfeed indicator will not go off if the paper is still jammed in the copier. Check again and remove all misfed paper.
- Do not touch or scratch the surface of the drum.

Handling

Removing a Paper Misfeed (Main Unit)

■ Paper exit area

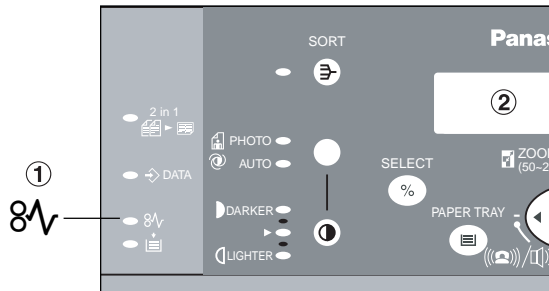

When an original misfeed has occurred

- ① Paper Misfeed Indicator will light.
- ② Paper misfeed message will appear in the message display.

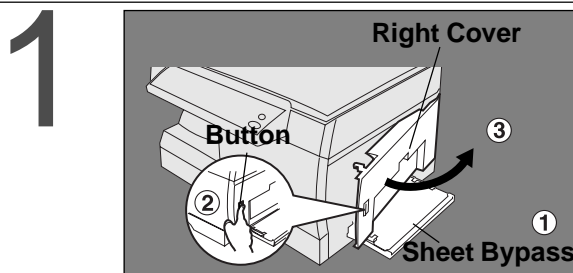

- ① Open the sheet bypass.
- ② Push the button.
- ③ Open the right cover.

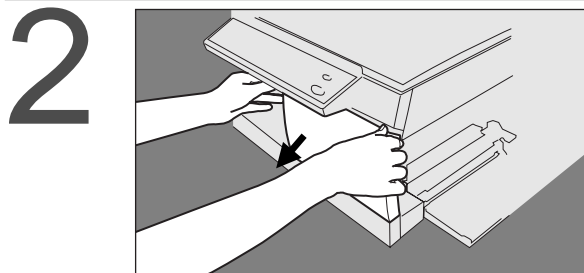

Open the front panel.

The front panel can not be opened until the right cover is open.
See procedure 1.

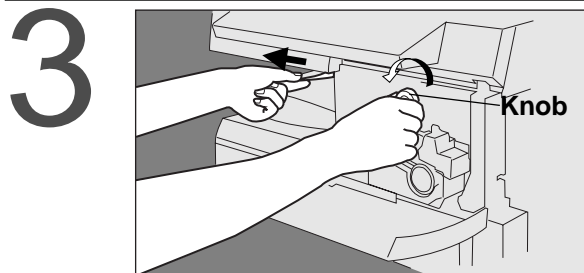

- ① Turn the knob.
- ② Remove the misfed paper.

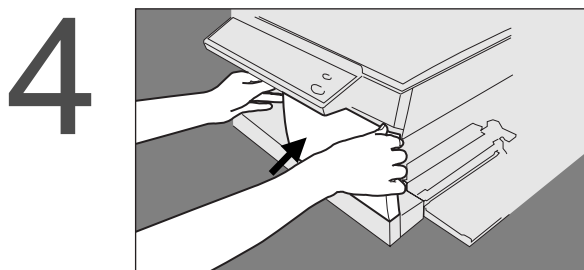

- ① Close the front panel.
- ② Close the right cover. (See page 9)
- ③ Close the sheet bypass.

ATTENTION

- Make sure that the misfeed indicator goes off after removing a paper misfeed. The misfeed indicator will not go off if the paper is still jammed in the copier. Check again and remove all misfed paper.

Removing an Original Misfeed (ADF)

■ ADF (Automatic Document Feeder) area

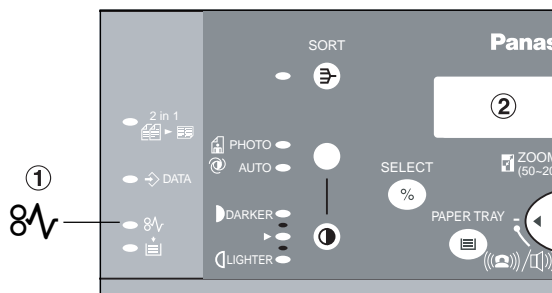

When an original misfeed has occurred

- ① Paper Misfeed Indicator will light.
- ② Paper misfeed message will appear in the message display.

1

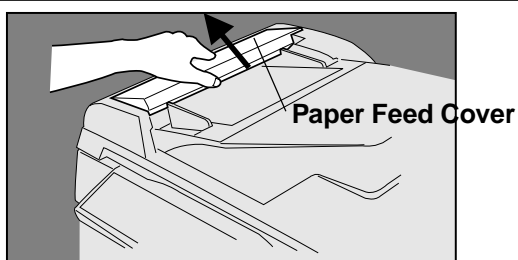

Paper Feed area:
Open paper feed cover of ADF.

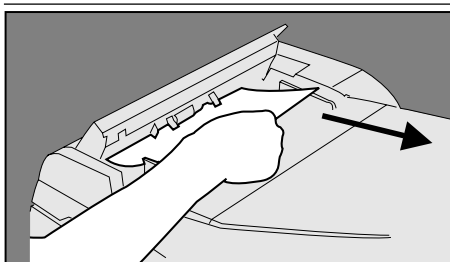

Remove misfed paper and close paper feed cover.

2

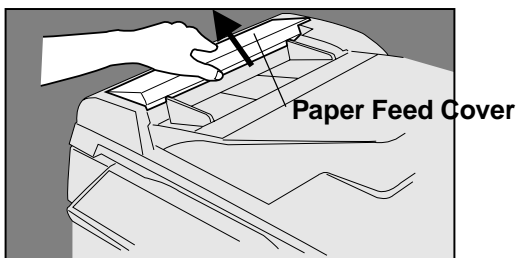

Paper exit area:
Open paper feed cover of ADF.

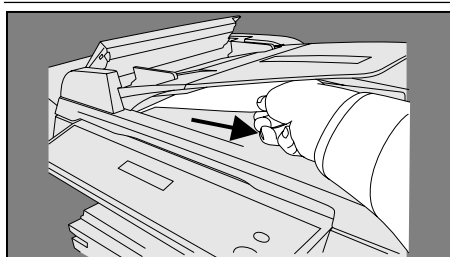

Remove misfed paper and close paper feed cover.

ATTENTION

- Make sure that the misfeed indicator goes off after removing a paper misfeed. The misfeed indicator will not go off if the paper is still jammed in the copier. Check again and remove all misfed paper.

Handling

Removing a Misfed Paper (2nd Paper Feed Module)

■ 2nd Paper Feed Module area

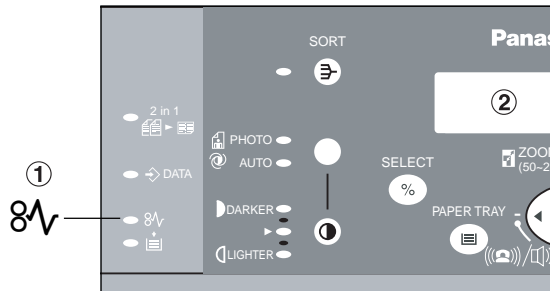

When an original misfeed has occurred

- ① Paper Misfeed Indicator will light.
- ② Paper misfeed message will appear in the message display.

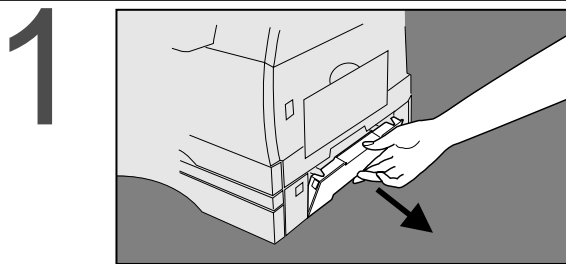

Open paper feed cover.

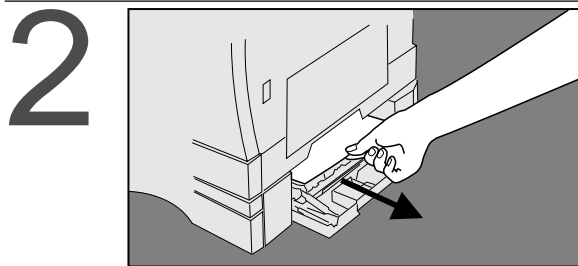

Remove misfed paper.

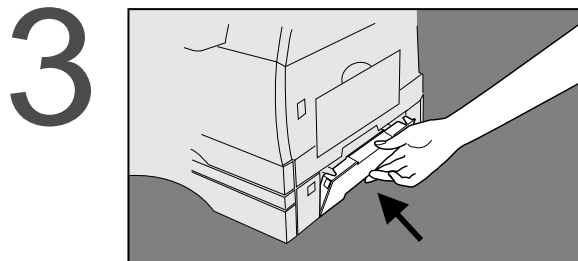

Close paper feed cover.

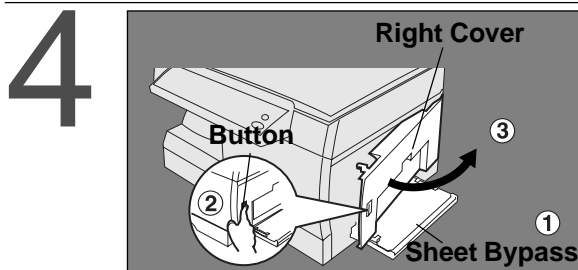

To clear the paper misfeed indicator.

- ① Open the sheet bypass.
- ② Push the button.
- ③ Open the right cover.
- ④ Close the right cover.
- ⑤ Close the sheet bypass.

ATTENTION

- Make sure that the misfeed indicator goes off after removing a paper misfeed. The misfeed indicator will not go off if the paper is still jammed in the copier. Check again and remove all misfed paper.
- Do not open the rear cover of the 2nd Paper Feed module. And do not touch to the gear area. Fingers might be wedged between gears.

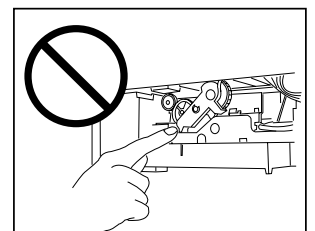

Checking

Troubleshooting

Check	Action
Unit does not operate	
Does the display light?	➔ Check if the Power Switch is turned on and if the power plug is inserted into the outlet.
Is Energy Saver key flashing?	➔ Press Energy saver key on control panel.
Does the Add Paper Indicator appear on display? (☰)	➔ Add paper. (See page 21) Or check if the paper tray is closed completely. When the 2nd paper feed module is not installed, the paper size should be selected "0: Not installed". (See page 22)
Does the Paper Misfeed Indicator appear on display? (8V)	➔ Remove the misfed paper. (See page 25-28)
Does "CLOSE RIGHT COVER" appear on message display?	➔ Right cover is open. Please close it.
Does U19 appear on message display?	➔ Check if toner cartridge is installed completely. (See page 23)
Does "CLOSE THE ADF" appear on message display?	➔ Close ADF (Automatic Document Feeder)
Does U40 appear on message display?	➔ Add paper to the sheet bypass and press Start.
Does any of the E#-## appear on display?	➔ Turn copier power switch off, then back on. If error code comes back again, call your Panasonic authorised dealer.
Does "INFO. CODE=####" appear on message display?	➔ Refer to the Information Codes of the Operating Instructions (For Facsimile) on page 89.
Does "JAN-01-1999" appear on message display?	➔ Replace the Litium Battery, refer to operating instructions (For Facsimile).

Copies are marked	
Is the copier platen glass or platen cover dirty?	➔ Clean the glass or platen cover. (See page 30)
Is the corona dirty?	➔ Need to clean corona. (See page 31)
Is the back side of copies dirty?	➔ Clean the roller. refer to operating instructions (For Facsimile).

Checking

Troubleshooting

Copies are light

Does the exposure indicator say "light"?



Press Auto/Photo Select Key to choose the auto mode. (See page 2)

Does the add toner indicator appear?



Change toner cartridge. (See page 23)

Light image on the front side of copier

Copy Image Sample

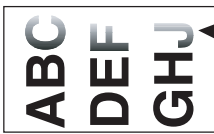

Image towards the front side of copier is light.



Push the green handle of the toner cartridge to right.

← Direction of paper exit

■ If the measures outlined above do not solve the problem, call your Service provider.

Cleaning

■ As a rule, clean once a week.

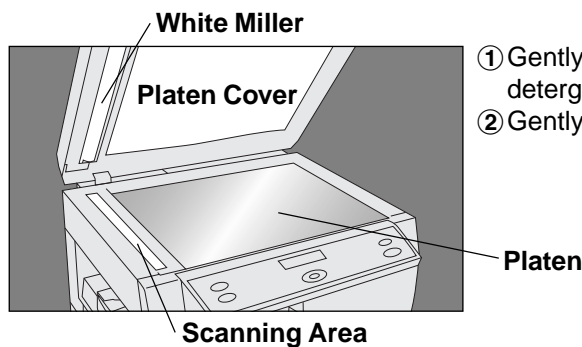

- ① Gently wipe marks off with cloth and neutral detergent.
- ② Gently wipe again with a dry cloth.

■ As a rule, clean monthly.

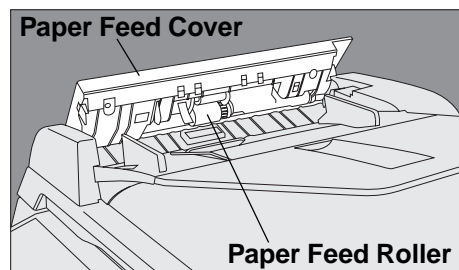

<Paper Feed Roller>

- ① Open the Paper Feed cover.
- ② Wipe paper feed roller with cloth and neutral detergent.
- ③ Gently wipe again with a dry cloth.

ATTENTION

- Do not use benzine, thinners or other volatile cleaners.

■ When copies become unclear, clean the Corona by following procedure.



(Sample)

Line images in the copy.

1

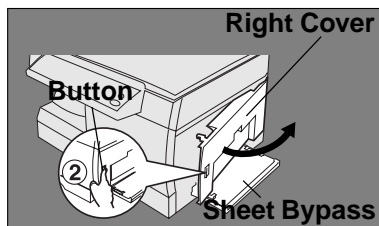

- ① Open the sheet bypass.
- ② Push the button.
- ③ Open the right cover.
- ④ Open the front panel.
- ⑤ Pull the green hook of toner cartridge.

2

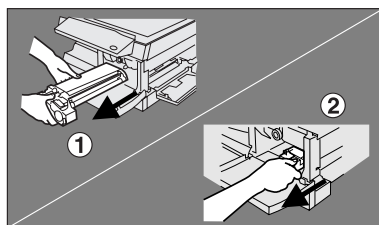

- ① Remove the toner cartridge.
- ② Remove the drum unit by pulling the handle with green label.

3

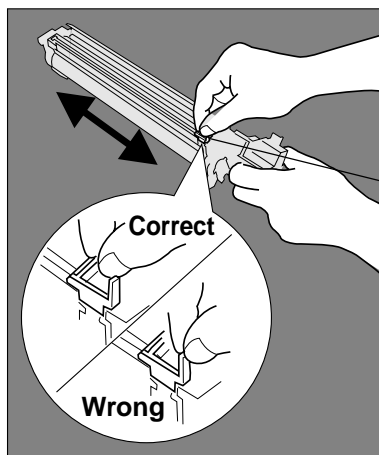

- ① Slide corona cleaner (green) back and forth one or two times.
- ② Put the corona cleaner to original position.

Corona Cleaner (Original Position)

4

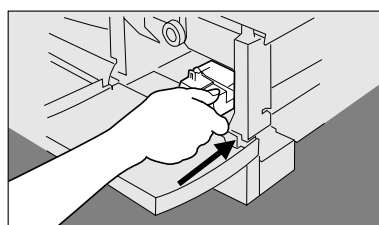

Reinstall the drum unit.

5

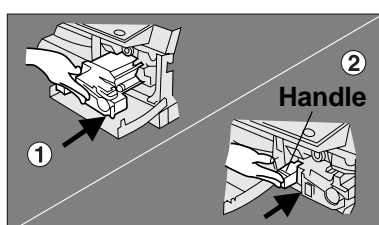

- ① Re-install the toner cartridge.
- ② Push the green handle until it locks.
- ③ Close the front panel.
- ④ Close the right cover. (See page 9)
- ⑤ Close the sheet bypass.

Specifications

Copier Functions

■ Main unit

Type:	Desk Top
Copy/Print Process:	Laser/Electrostatic photographic method
Process:	Dry, New Mgnefine High Definition Toner
Resolution:	Max. 600 dpi
Multi-Copy Speed:	15 A4 size copies per minute
Maximum Copy Size:	B4 (257 × 364 mm) Void Area: max. 5.0 mm
Copy Size:	A4R – A5R via paper tray A4R – A5R via sheet bypass
Reduction Ratios:	Preset: 82%, 71%, 58% Variable: from 99% to 50% in 1% increments
Enlargement Ratios:	Preset: 141% Variable: from 101% to 200% in 1% increments
Paper Feed:	250 sheet paper tray plus 50 sheet bypass
Quantity Selector:	1 - 99, Automatic Repeat, Automatic Reset to 1
Paper Weight:	60 – 90 g/m ² (Paper Tray) 55 – 130 g/m ² (Sheet Bypass)
Exposure Control:	Automatic/Manual plus Photo Mode
Dimensions:	496 (W) × 487 (D) × 383 (H) mm (with ADF)
Weight:	22.6 kg (including ADF)
Electrical Requirements:	AC 220-240V, 50/60Hz, 4.5A

■ ADF (Automatic Document Feeder)

Original Capacity:	30 sheets (80 g/m ²)
Paper Size:	A5R, A4R, B4
Paper Weight:	50-105 g/m ²
Electrical Requirements:	Supplied from copier
Dimensions:	496 (W) × 487 (D) × 110 (H) mm

■ 2nd Paper Feed Module (DA-DS150) (Option)

Paper Size:	A5R, A4R, B4
Paper Weight:	60-90 g/m ²
Original Capacity:	250 sheets
Electrical Requirements:	Supplied from copier
Dimensions:	496 (W) × 487 (D) × 90 (H) mm
Weight:	3.2 kg

Note: To see total count of copies, press and hold % Select key, then press CLEAR/STOP key.

Consumables List

■ Consumables List

When ordering consumables, please use the correct part number as listed below.

Consumable Name	Part Number	Yield
Toner Cartridge	DQ-UG15A	Approx. 5,000 sheets*
Drum Unit	DQ-UH32A	Approx. 30,000 sheets

* Based on copying a A4 size 6% image area original.

Note: To see total count of copies, press and hold % Select key, then press CLEAR/STOP key.
To print total count of copies, press and hold % Select key, then press START key.

IMPORTANT INFORMATION

When requesting information, supplies or service always refer to the model and serial number of your machine. The model and serial number plate (Main Name Plate) is located on the rear side of machine. For your convenience, space is provided below to record information you may need in the future.

Model No.

Serial No.

Date of Purchase

Dealer

Address

Telephone Number

()

Supplies Telephone Number

()

Service Telephone Number

()