

Amplifier Specifications	PT2000	PT1600	PT1200
Input Impedance	20 k-Ohms	20 k-Ohms	20 k-Ohms
Continuous Output Power			
Stereo Mode			
20 Hz to 20 kHz, 8 Ohms	120W x 2	100W x 2	70W x 2
1 kHz, 4 Ohms	175W x 2	140W x 2	100W x 2
Maximum Power, 4 Ohms	1000W x 2	800W x 2	600W x 2
Bridged Mode			
20 Hz to 20 kHz, 8 Ohms	300W x 1	250W x 1	150W x 1
1 kHz, 4 Ohms	350W x 1	280W x 1	200W x 1
Maximum Power, 4 Ohms	2000W x 1	1600W x 1	1200W x 1
THD at rated output power	0.1%	0.1%	0.1%
Frequency Response +/- 3 dB	10 Hz to 50 kHz	10 Hz to 50 kHz	10 Hz to 50 kHz
Input Sensitivity for rated output power	0.775V	0.775V	0.775V
Signal-to-Noise Ratio A-Weighted	90 dB	90 dB	90 dB
Speaker Impedance			
A or B only	4-16 Ohms	4-16 Ohms	4-16 Ohms
A plus B	8-16 Ohms	8-16 Ohms	8-16 Ohms
Bridged Mode	8-16 Ohms	8-16 Ohms	8-16 Ohms
Power Requirement	120 VAC, 60 Hz	120 VAC, 60 Hz	120 VAC, 60 Hz
Power Fuse	7A/250V	6A/250V	5A/250V
Dimensions H x W x D, inches (mm)	5 1/8 x 19 x 12 (130 x 482 x 305)	4 15/32 x 18 7/8 x 12 (114 x 480 x 305)	4 3/16 x 18 15/16 x 10 3/4 (100 x 482 x 273)
Weight, lbs (kg)	28.19 (12.8)	24.67 (11.2)	19.82 (9.0)



P T 2 0 0 0 A m p l i f i e r



P T 1 6 0 0 A m p l i f i e r



P T 1 2 0 0 A m p l i f i e r

Owner's Manual

Thank you for purchasing this PYLE product. To activate your warranty, please mail this card within 10 days.

warranty registration card

PYLE PRO AMPLIFIERS

Name _____

Address _____

City, State ZIP _____

Model No. _____

Date of Purchase _____

Serial # (if available) _____

Purchased at:

Music Products Store

Sound Contractor/Installer

Mail Order

Catalog Merchandiser

Other _____

▶ Please complete warranty card, detach and return ▶

Limited Warranty

All PYLE PRO products are carefully constructed and tested before shipment. Units purchased in the USA are warranted to be free of defects in material and workmanship for two (2) years from the date of purchase. This warranty is limited to the original retail purchaser of the amplifier.

Should the unit fail due to factory defects in material or workmanship, your unit will be repaired or replaced at the sole discretion of PYLE.

To obtain warranty service, you must first call our Consumer Return Hotline at (718) 236-6948 to obtain a Return Authorization Number. This R.A. # must appear on the outside of your package and on all paperwork relating to your return.

When returning the unit to us for warranty service, it must be carefully packed and shipped, prepaid, to:

PYLE PRO R.A.#: _____
 PYLE PRO Service Center
 1600 63rd Street
 Brooklyn, NY 11204

You must also include the following items with your return:

- A copy of your sales receipt or other proof of purchase
- A brief letter, indicating the problem you are experiencing with the product
- Include in your letter your return address, daytime phone number and R.A. number
- Also include a check or money order for \$15.00 for return shipping, handling and insurance, or provide your Visa/MC number with expiration date.

Our obligation under this warranty is limited to the repair or replacement of the defective unit when it is returned to us prepaid. This warranty will be considered void if the unit was tampered with, improperly serviced or subject to misuse, neglect or accidental damage.

TABLE OF CONTENTS

- 1 Features and controls, PT2000 and PT1600
- 2 Features and controls, PT1200
- 3 Installation Guidelines
- 3 Input Connections
- 3 Connecting a CD or tape player or tuner
- 3 Connecting an additional CD sound source
- 3 Connecting an equalizer or signal processor
- 3 Connecting microphones
- 3 Speaker connections
- 3 Connector options
- 4 Bridged Mode Operation
- 4 Using headphones
- 4 Connecting to AC power
- 4 Mounting the amplifier
- 4 Turning the amplifier on
- 4 Using the power meter (PT2000 and PT1600 only)
- 4 Using the meter range selector (PT2000 and PT1600 only)
- 5 Using the left and right output level controls
- 5 About the internal clip circuitry
- 5 Using the A/B Speaker Selector
- 5 Caring for your Pyle Pro Amplifier
- 5 Replacing a fuse
- 6 Specifications
- 6 Limited warranty

Your new Pyle Pro PT Series P.A. Amplifier gives you the power and versatility you need in a professional sound system. The amplifier's wide frequency response makes it suitable for amplifying music or vocal program material. It can be used for live bands, office paging systems, public announcement systems, or a variety of other installations.



Please read this manual thoroughly before you attempt to set up and use the amplifier. It contains a range of installation suggestions as well as instructions to ensure safe usage. Installed properly, you can expect years of trouble-free service from this product.

FEATURES AND CONTROLS

FRONT PANEL, PT2000

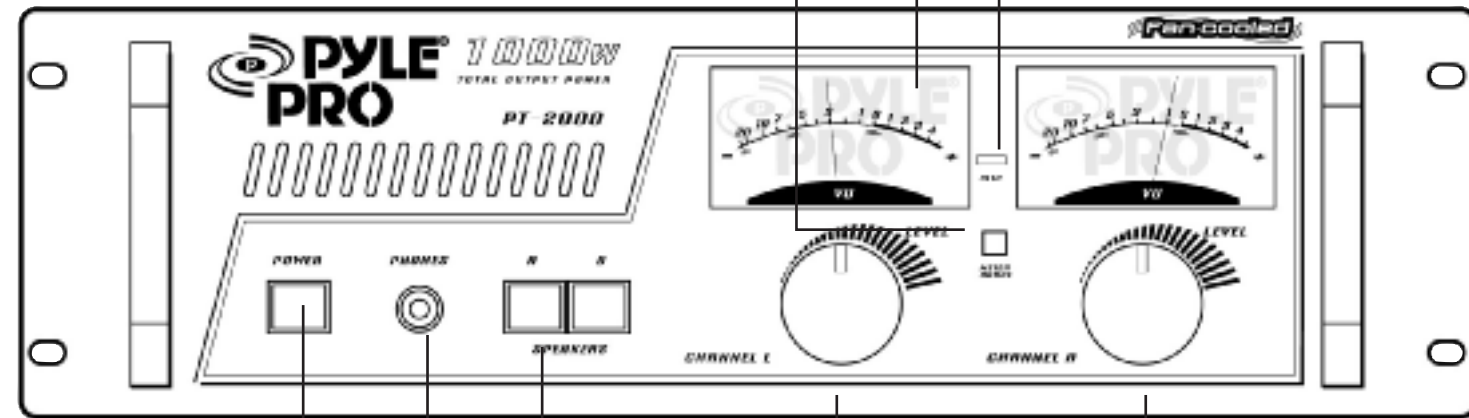

- Power On/Off**
- Phone Jack**
Lets you connect a pair of stereo headphones for private listening or cueing (monitoring) sound prior to "airing" it.
- Speaker A/B Selector Switches**
Permits you to select speakers attached to terminal set A, set B or both.
- Meter Range Switch**
Controls the sensitivity of the power meter
- Clip Circuit and Indicator**
This special circuitry protects the amplifier and speaker system from being damaged by overdriving power levels. Indicator lights remind the user to reduce the volume when amplifier output is excessive.
- Left and Right Output Level Controls**
Lets you adjust the sound levels for each channel



FEATURES AND CONTROLS

FRONT PANEL, PT1600

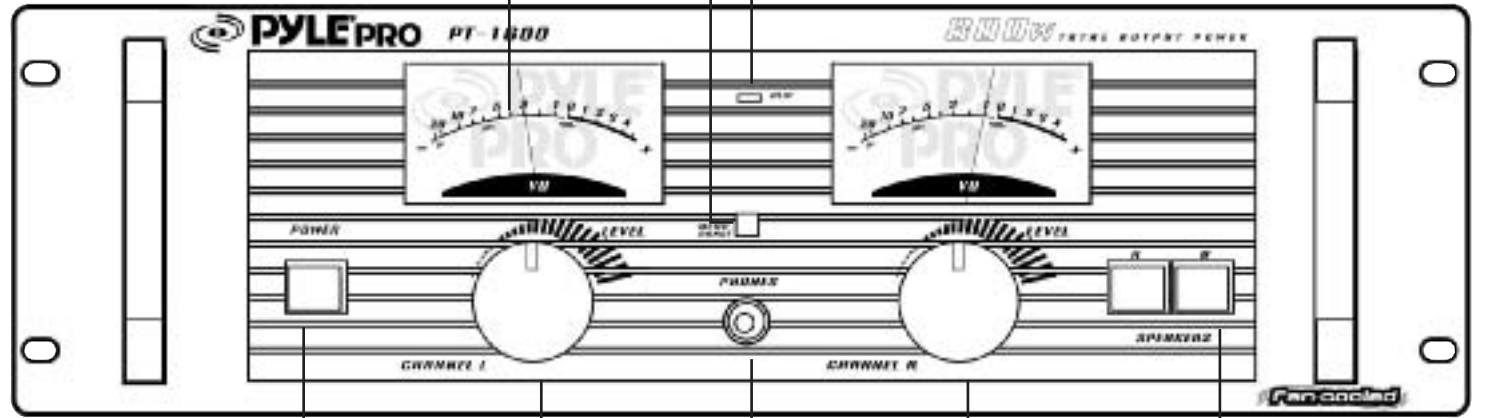

- Left and Right Power Meters**
Indicates the output signal level for each channel
- Meter Range Switch**
Controls the sensitivity of the power meter
- Clip Circuit and Indicator**
This special circuitry protects the amplifier and speaker system from being damaged by overdriving power levels. Indicator lights remind the user to reduce the volume when amplifier output is excessive.
- Power On/Off**
- Phone Jack**
Lets you connect a pair of stereo headphones for private listening or cueing (monitoring) sound prior to "airing" it.
- Left and Right Output Level Controls**
Lets you adjust the sound levels for each channel
- Speaker A/B Selector Switches**
Permits you to select speakers attached to terminal set A, set B or both.

REAR PANEL, PT2000 and PT1600

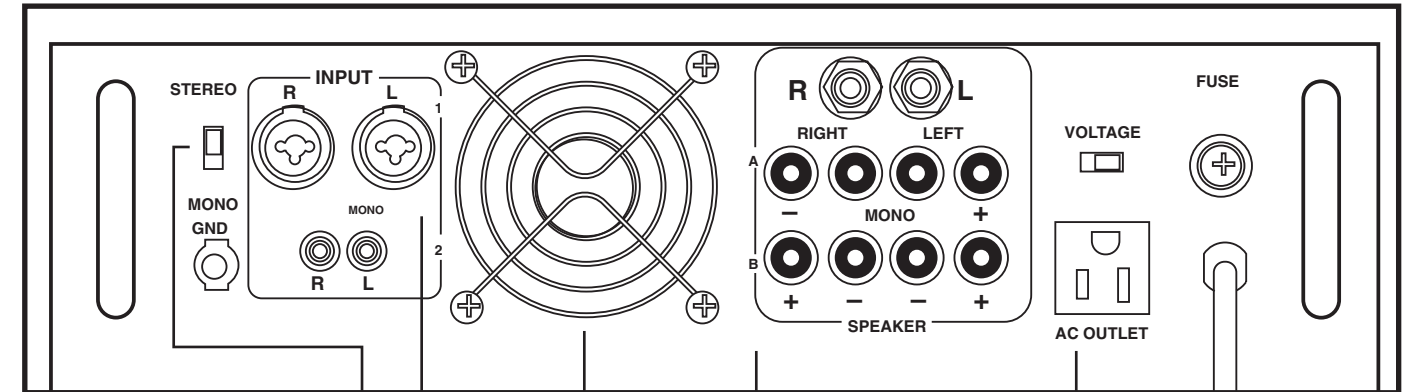

- Stereo/Mono Selector**
Lets you select bridged mono input mode in combination with a mono signal source plugged into the Left channel, or conventional stereo operation with a stereo input signal.
- Input Jacks**
Lets you connect a variety of audio input sources via the balanced (XLR/6.35mm phone jack combinations) or unbalanced (RCA) inputs.
- Speaker terminals**
Permits hookup of two stereo pairs of speakers via the wire terminals. Speaker pair A can also be connected via the 6.35 mm phone jacks provided.
- Fan Cooling**
Cooling system is automatically activated whenever amplifier is turned on. This forced air cooling system rapidly exhausts interior heat, reducing operating temperature and aiding performance.
- AC Outlet**
This switched outlet allows the electrical hookup of other units, with maximum load of 300W.

FEATURES AND CONTROLS

FRONT PANEL, PT1200

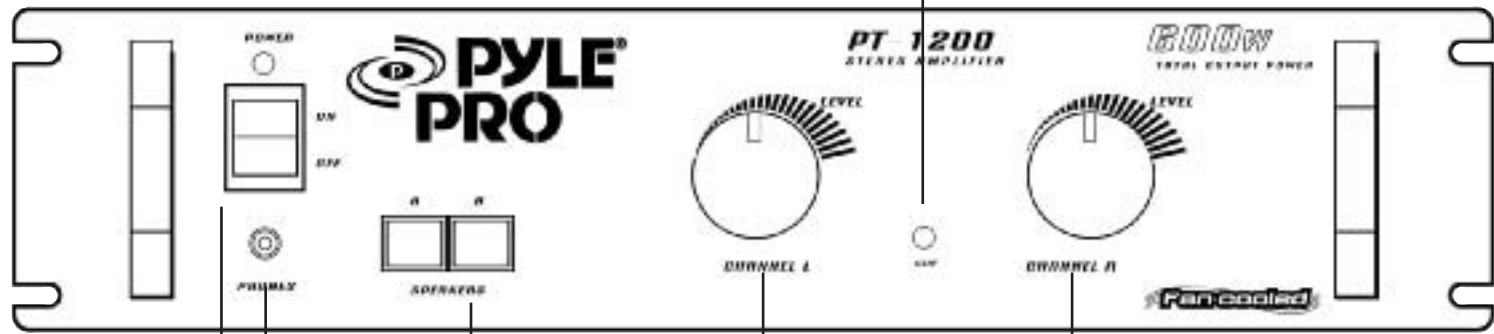

Clip Circuit and Indicator
This special circuitry protects the amplifier and speaker system from being damaged by overdriving power levels. Indicator lights remind the user to reduce the volume when amplifier output is excessive.

Power On/Off

Phone Jack
Lets you connect a pair of stereo headphones for private listening or cueing (monitoring) sound prior to "airing" it.

Left and Right Output Level Controls
Lets you adjust the sound levels for each channel

Speaker A/B Selector Switches
Permits you to select speakers attached to terminal set A, set B or both.

REAR PANEL, PT1200

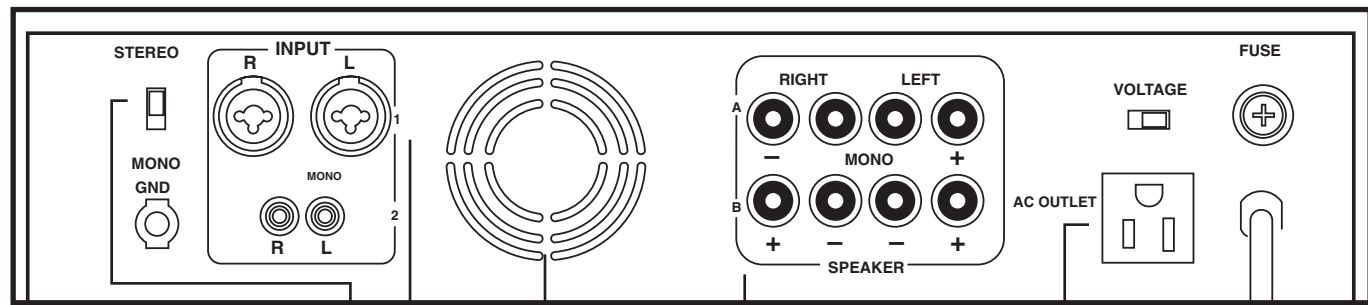

Stereo/Mono Selector
Lets you select bridged mono input mode in combination with a mono signal source plugged into the Left channel, or conventional stereo operation with a stereo input signal.

Input Jacks
Lets you connect a variety of audio input sources via the balanced (XLR/6.35mm phone jack combinations) or unbalanced (RCA) inputs.

Speaker terminals
Permits hookup of two stereo pairs of speakers via the wire terminals.

AC Outlet
This switched outlet allows the electrical hookup of other units, with maximum load of 300W.

Fan Cooling
Cooling system is automatically activated whenever amplifier is turned on. This forced air cooling system rapidly exhausts interior heat, reducing operating temperature and aiding performance.



INSTALLATION GUIDELINES

Connecting the GND (Ground) screw terminal
Connecting a mixer or preamplifier may cause excessive noise or hum in the amplifier output. To prevent this, connect one end of a low-capacitance shielded wire to the amplifier's ground screw (on the rear panel). Then connect the other end of this wire to the ground terminal on the mixer or preamplifier enclosure.

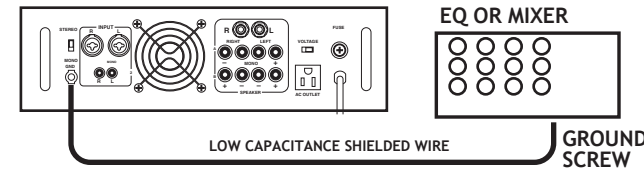

Input connections
These amplifiers accept a broad range of input sources, including Compact Disc (CD) players; Cassette, Reel-to-Reel or other tape players; Radio Tuners; Equalizers; Signal Processors.

Connecting a CD or tape player or tuner
In a normal installation, one would use the RCA JACKS for connecting a CD player, tape player or tuner

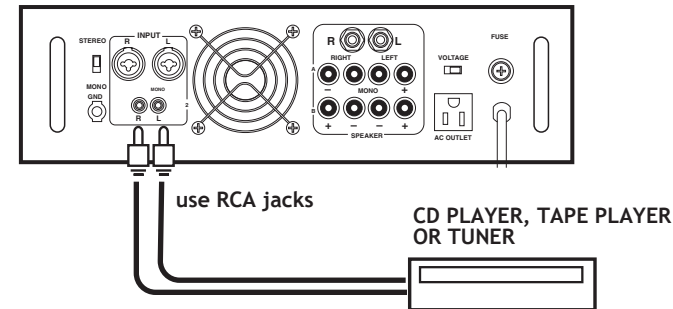

Connecting an equalizer or external signal processor
Connect the processor's OUT to the amplifier's IN connector.

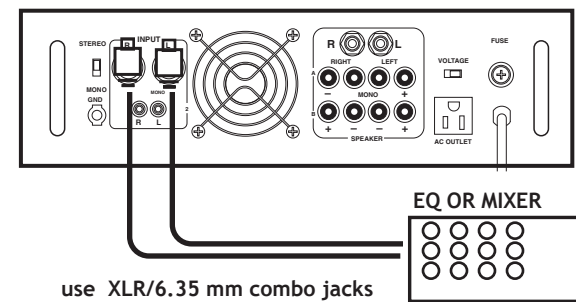
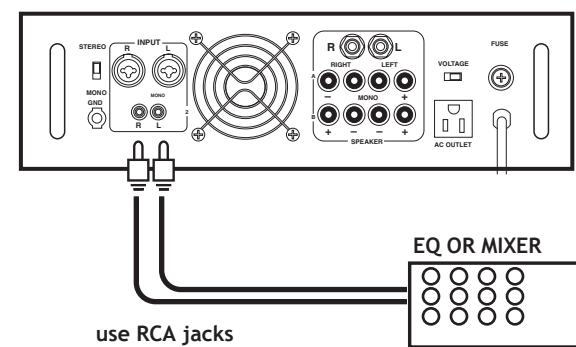

Stereo or Mono Inputs
Your Pyle Pro amplifier can be operated in Stereo or Mono mode, depending on the input source. If the input signal is mono, connect the source via the LEFT input only (also marked "MONO" on the back of the amplifier). Then slide the Stereo/Mono selector switch to MONO and the signal will be routed through both channels.

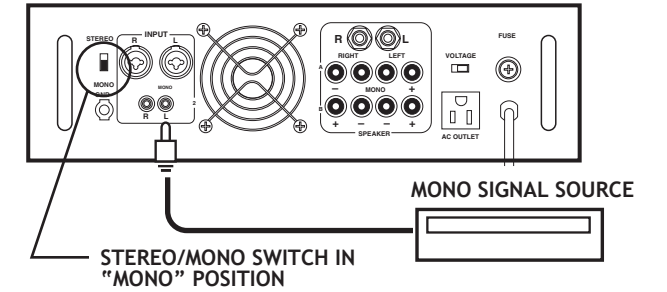

Speaker connections
You can connect 4 Ohm, 8 Ohm or 16 Ohm speakers to Channel A and/or Channel B of the amplifier. If you connect two pairs of speakers, be sure to follow these guidelines:

- Speakers which are connected to the same channel are part of a pair, and must be of the same impedance.
- Speakers connected to different channels are NOT part of a pair, and can be of different impedances.

1. Prepare the speaker wire by removing about 1 inch of insulation from the end of the speaker wire you intend to connect to the amplifier. Then twist the exposed wire to secure all the wire strands.

NOTE: Use 18-gauge speaker wire for lengths up to 25 feet; 16-gauge wire for lengths over 25 feet. It is recommended that you use the shortest length of wire possible.

2. Connect the speaker wires to the speaker's positive and negative terminals.

NOTE: Most speaker terminals are either color-coded or have a mark that indicates the terminal's polarity. Usually positive terminals are red or have a plus symbol (+), and negative terminals are black or have a minus symbol (-).

3. Connect the speaker wires to the amplifier's left and right speaker terminals according to the terminal color polarity.

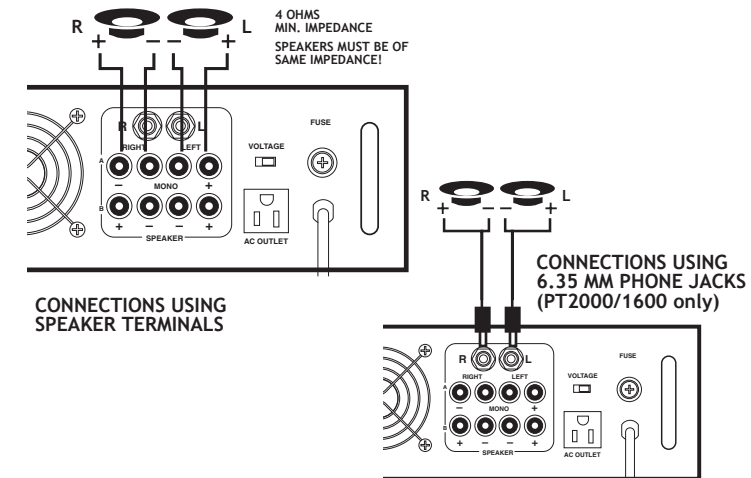

Bridged Mode Operation

This amplifier can operate in a mono bridged output mode, if your speakers can handle the following power output levels:

- PT-2000: 350 watts
- PT-1600: 280 watts
- PT-1200: 200 watts

As shown in the diagram below, connect the speaker's positive (+) to the amplifier's red speakers left (A/B) terminals and negative (-) to red speakers right (A/B) terminals.

The speaker right (+) on the amplifier is used as a negative (-) terminal for a bridged connection.

NOTE: The extra amplifier output of 6.35mm phone jacks can not be used for the bridged connection. It can only be used in normal (non-bridged) operation as a stereo speaker output.

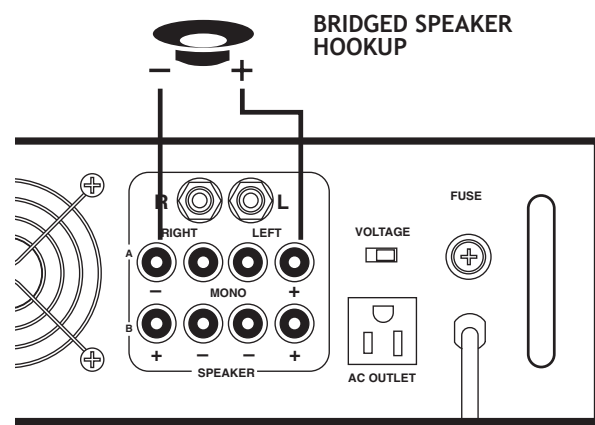

Using headphones

To listen privately, or to monitor sound sources, connect a pair of low impedance stereo headphones (not supplied) with a 6.35 mm plug into the PHONES jack on the amplifier front panel.

Please listen safely. Follow these recommendations:

Do not listen at extremely high volume levels. Extended, high-volume listening can lead to permanent hearing loss.

Always start with the volume control set to a LOW level BEFORE you put the headphones on. Then gradually increase the volume as necessary.

Once you set the volume, do not increase it. Over a period of time, your ears adapt to the volume level, so a volume level which does not cause immediate discomfort may still be actually damaging your hearing.

Connecting to standard AC power

After making all other connections, set the POWER switch to OFF position. Then connect the power cord to a standard AC outlet.

Mounting the amplifier

This amplifier is designed to accept standard rack mounting installations. Two slots on each end of the front panel make it suitable for such an installation.

Tightly secure four mounting screws (not supplied) through these four slots and into your standard electronics equipment rack.

Turning the amplifier on

1. Turn on the audio input source equipment which is connected to the amplifier INPUT jacks.
2. Set the amplifier's left and right output level gain controls to the minimum level settings.
3. Push in the power switch to turn the amplifier on.

Using the power meter (PT2000 and PT1600 only)

The meter pointer position indicates the amplifier output power. For ease of reading in dark environments, the meter is illuminated.

Using the meter range selector (PT2000 and PT1600 only)

When output power is too strong, the meter's pointer might continuously swing to the extreme right and damage or reduce the accuracy of the meter. To protect the meter, you can use the meter range selector to control the amplifier's sensitivity to the input power signal. Leave the meter range switch in the OUT position to maintain a 0 dB gain for the meter. When output power is not strong, leave the meter range switch in the IN position to allow a +20dB gain.

Using the Left and Right Output Level controls

Rotate output level gain clockwise to increase, or counterclockwise to decrease the output power. To get the best performance with the least sound distortion, always adjust the output level gain so the meter's pointer does not continuously exceed the extreme right of the meter's scale.

CAUTION: It is possible to overdrive the amplifier by setting output level gain too high, which may cause damage or failure.

About the internal clip circuitry

Special clip circuitry incorporated into your Pyle Pro amplifier's design protects the amplifier and speaker system from being damaged from overdriving power.

Under normal conditions, the amplifier's clip indicator will flicker as the output power momentarily exceeds the level as set by the output level gain selector.

However, under excessive output conditions, the clip indicator lights remain on continuously, alerting you that the special clip circuitry has become active. When this occurs, you should simply reduce the output power level by rotating the Master Volume control counterclockwise.

Using the A/B Speaker Selector Switch

You can listen to speakers on set A or set B individually or simultaneously. Simply push in or out the desired speaker set to make your selection.

CAUTION: If the impedance of your speakers is 4 ohms, do not use both the speaker A and speaker B terminal at the same time as the net impedance may be low enough to damage your amplifier!

Caring for your Pyle Pro Amplifier

Your Pyle Pro Amplifier is an example of superior design and craftsmanship. The following suggestions will help you care for your amplifier so you can enjoy years of use:

- Keep the amplifier dry. If it gets wet, wipe immediately.
- Use the amplifier only in well-ventilated installations.
- Handle the amplifier gently and carefully - do not drop!
- Keep the amplifier away from dust and dirt.
- Wipe occasionally with a damp cloth to keep it looking new. Do not use harsh chemicals, solvents or detergents!

Replacing a fuse

This amplifier requires a fuse with the proper rating for protection from power surges and short circuits. If the amplifier suddenly turns off or will not turn on, the fuse is probably blown.

To replace the fuse:

1. Unscrew the fuse compartment cap on the back of the amplifier.
2. Remove the old fuse and replace it with an identical, serviceable fuse:
 - PT-2000 = 7A/250V
 - PT-1600 = 6A/250V
 - PT-1200 = 5A/250V

CAUTION: Never use a fuse with a higher rating.

3. Replace the fuse compartment cap.



Place
Stamp
Here

