



SG 305

Gas Cooker

Operating
and
Installation Instructions

Introduction

This gas appliance has been designed and manufactured to all the necessary British Standards. It also carries the C.E. mark. The appliance complies with European Council Directive 90/396/EEC.

It is important that you understand how to use and care for the appliance properly before you use it for the first time.

We have written this booklet with your safety in mind. Read the booklet thoroughly before you use the appliance. Keep the booklet in a safe place so that anyone who uses the appliance can read it. Pass the booklet on with the appliance if you give or sell it to someone else.

For your safety

This appliance is not intended to be operated by means of an external timer or separate remote control system.

This appliance is designed for domestic use to cook food. You must not use it for any other purpose. It is not designed for commercial use.

Keep children, babies and toddlers away from the appliance at all times.

The installation instructions at the back of this book, on page 23, tell you how and where it can be fitted. If the appliance is already installed you must make sure that all instructions have been followed. If you are in any doubt ask a registered person.

We have included several drawings to show the right and wrong way of doing things.

The right way will have a smiling face by it.



A sad face shows something is wrong.



RATING PLATE

This is situated on the lower front frame of the appliance and can be seen upon opening the door. Alternatively the rating plate may also be found on the back or top of some models (Where applicable). **Do not remove the rating plate from the appliance as this may invalidate the guarantee.**

Contents	Page
Lighting the appliance	4
The grill	7
The hotplate	10
The oven	13
Oven cooking chart	15
Slow cooking	18
Care and cleaning	20
Installing the appliance	23
General information	25
What is wrong and why?	27
Servicing	28
Installation Instructions	30
Technical data	31
Safety requirements/ventilation	32
Location of appliance/installation	33
Testing	35

Lighting the appliance

The ignition system works by means of a battery. Details on how to replace the battery are given on page 25.

Hotplate

To light

Push in the control knob and turn to the large flame symbol (highest setting), and press the ignition button immediately. When the burner has lit release the button.

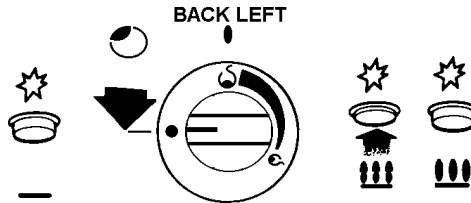

Warning: If the ignition button is not pressed immediately a build up of gas may cause the flame to spread.

Grill

To light:

- 1 Open the door.
- 2 Push in the control knob and turn it to the large flame symbol (highest setting), and press the ignition button immediately. When the burner has lit release the button.

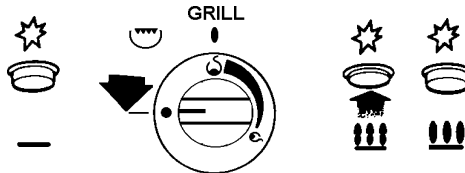

- 3 Leave the grill door open when you are using the grill.

Warning: If the ignition button is not pressed immediately a build up of gas may cause the flame to spread from the grill cavity.

For your safety

Never cover the grill pan or grid with foil as this can lead to grill fires.

Oven

To light:

- 1 Open the oven door.
- 2 Push in the control knob and turn it to gas mark 9, and press the ignition button immediately. When the burner has lit release the button. There will only be small flames at first.

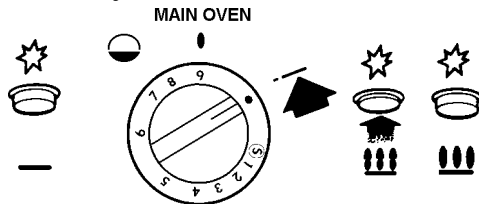

- 3 Now turn the control knob to the gas mark you want.
- 4 Wait until the burner is showing large flames.
- 5 Close the oven door.

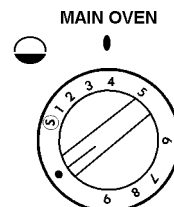

To turn off any burner

- 1 Push in the control knob and turn it to the off position. This is shown by a large dot.

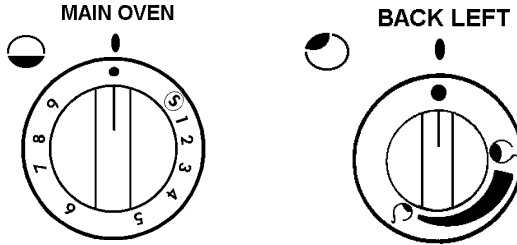

For your safety

When you are lighting any burner check that it has lit before you leave the appliance.

When you are turning off a burner, **do not** leave the appliance until the flame has gone out.

The grill

The grill is a high-speed grill. The instructions below tell you how to vary the heat setting and how to change the height of the grid to suit the food you are cooking. You should remember to turn the food regularly.

You should not use the grill to keep food warm as it will continue to cook the food.

Prior to using the grill

We suggest that you operate the grill for approximately 5 - 10 mins to burn off any residue from the surface. During this period a slight odour may be emitted, it is therefore advisable to open a window for ventilation.

When you first operate the grill you may hear some sounds as the burner heats up, this is quite normal and is not a fault on the appliance.

For your safety

The grill pan and handle must be in place before igniting the grill. You must keep the grill door open when the grill burner is lit. Accessible parts may be hot when the grill is used. Young children should be kept away. Never cover the grill pan or grid with foil as this can lead to grill fires.

Heat control

The grill control has two heat settings.

The control knob turns to the left from 'OFF' to 'HIGH' and then to 'LOW'. Use the high setting for fast cooking such as toast. Use the low setting to cook thicker food such as chicken after you have browned it on the high setting.

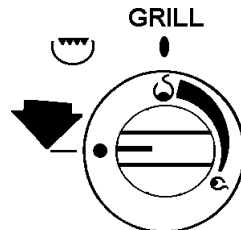

Cooking positions

There is only one position for the grill shelf (Position 2). Positions are counted from the top downwards.

Most food should be cooked on the grid in the grill pan. You can turn the grid over to suit different thicknesses of food.

You can place some dishes straight on to the grill shelf. This is useful when you are browning the top of food such as cauliflower cheese.

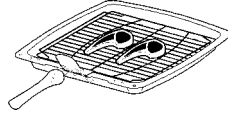
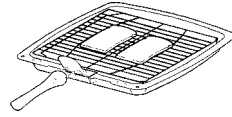

Plate warming

You can use the grill compartment to warm plates when you are using the oven.

Preheating

You don't usually need to preheat the grill. You may wish to preheat it for a couple of minutes when you are cooking steak or browning food.

Positioning food on the grid

Place food such as toast, tea-cakes and muffins towards the centre of the grid.

Place food which needs a gentle heat, such as tomatoes and mushrooms towards the edge of the grid.

Arrange meat, meat products and fish to suit their thickness and how you like them cooked.

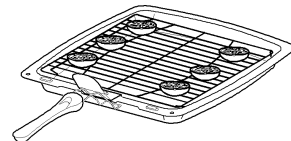
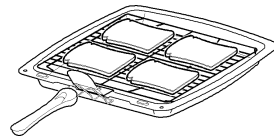

The grill pan and handle

The grill pan is supplied with a removable handle.

To attach the handle, place the wirework under the cut out in the pan so that the metal plate hooks over the top of the grill pan.

Slide the handle to the left and over the central bump on the grill pan.

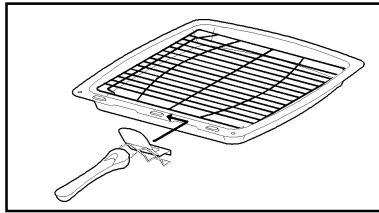

Ensure the handle is correctly located. It is not necessary to remove the grill pan handle during grilling.

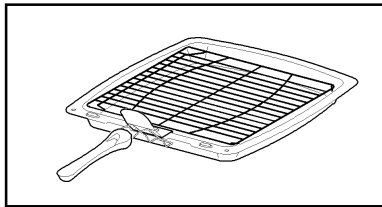

Place the grill pan on the shelf so that the pan is positioned centrally beneath the grill.

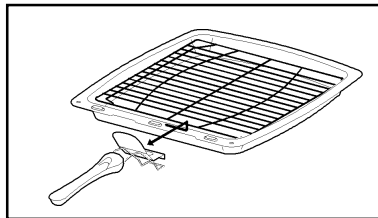

To remove the handle, slide the handle to the right and lift the handle away from the cut out on the grill pan.

Note

If you require an additional handle for your grill pan, this can be ordered from your local Service Force Centre by quoting part number 311479800\6.

The hotplate

If you have any trouble lighting a hotplate burner turn all hotplate control knobs off and make sure the hotplate burner parts have been replaced correctly. See page 21 for more information.

Heat control

The hotplate control knobs turn anticlockwise from 'OFF' to 'HIGH' and then to 'LOW'. You can adjust the heat by turning the control between the highest and lowest settings. These are shown as a large and a small flame symbol.

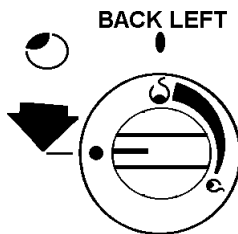

Burner sizes

The hotplate has three burner sizes to suit different types of cooking:

Largest burner (Rapid) - use a large pan for food such as chips.

Medium burners (Normal) - use for everyday cooking.

Small burner (Simmer) - use for simmering food such as soups and stews.

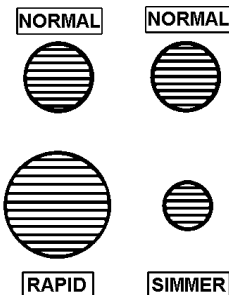

The largest pan which you should use on any burner is 230mm (9").
The base of the smallest pan should not measure less than 100mm (4").



Lift pans on and off the pan supports. Do not slide them across the hob.





For your safety





1 Take care to avoid burns and scalds when you are reaching across the hotplate.



2  Use pans with flat bases. They are more stable than pans which are warped. 

3  **Do not** use pans with very heavy handles which cause the pan to tip. 

4  Put pans on the centre of the burners.



5  Position pan handles so they cannot be accidentally knocked. 

6  Take extra care when you are deep fat frying. **Do not** cover the pan with a lid. 



 **Do not** leave a pan unattended. If the pan catches fire, leave it where it is and turn off all controls.

 Place a damp cloth or a fitting lid over the pan to smother the flames.

Never put water on the fire.











Leave the pan to cool for 30 minutes.

7  If you are using a Wok we recommend it has a flat base as it will stand stable on the pan supports. If you use a round based Wok with a collar support, the collar must be of the open wire work type. A closed collar will affect the performance of the burner. Before you use the Wok make sure that the collar is stable on the pan supports.  Always follow the instructions that come with the Wok. 



Helpful hints

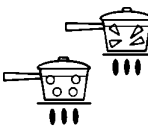

- 1  Keep flames under the base of the pans. If the flames lick round the sides of the pans you are wasting gas. 
- 2  Only heat the amount of liquid you need. **Do not** overfill pans. 
- 3  Cover pans with a lid whenever possible. The food will heat up more quickly and there will be less steam in the kitchen. 
- 4  Try cooking more than one vegetable in the same pan, for example potatoes and carrots. 
- 5  Cut vegetables into smaller pieces. This way they will cook more quickly. 
- 6 A pressure cooker will save time and energy.

The oven

Before you use the oven you should wipe it out with a damp cloth to remove any dust.

Heat zones

There are zones of heat within the oven. The temperature in the middle is the gas mark you have chosen. The top of the oven is slightly hotter and the lower shelf slightly cooler. The base of the oven is quite a lot cooler. You can make use of these heat zones when you are cooking foods that need different temperatures all at the same time.

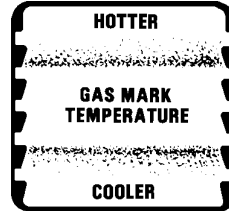

If you are cooking more than one tray of similar items, for example cakes or biscuits, swap the trays around during cooking. Or you can remove the top tray when the food is cooked and move the lower tray to the higher shelf to finish cooking.

Preheating

You do not need to preheat the oven when casseroles and so on.

Preheat the oven for baking or when you are cooking sensitive food such as Yorkshire puddings, soufflés and yeast mixtures.

When you are cooking or reheating frozen or chilled food read the instructions on the packing.

When you need to preheat the oven, we recommend you do so for 20 minutes.





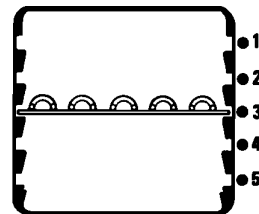

Oven shelves

You can slot the oven shelves into any of five positions. Positions are counted from the top downwards.

For safety the shelf will only pull out so far. If you want to remove a shelf completely pull it forward as far as it will go, raise the front edge and lift it out. To put the shelf into a different position keep the front edge raised, slot the shelf on to the runner, lower the front edge and slide the shelf in.

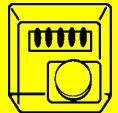

Baking trays and dishes

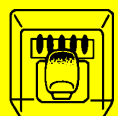
	For your safety	
	Never place cooking dishes, trays and so on over the oven burners. This will damage the appliance as well as the cookware and possibly the floor covering underneath the appliance.	
	Leave a gap of 13mm (½") between all dishes and the sides of the oven so the heat can circulate properly.	
	Do not push dishes too far back as food will burn if it overhangs the burner flames.	

For the best results we recommend that you use a baking tray which is 310mm (12") square. If you use a tray or tin which is larger than this, you may need to turn the food around during cooking.

Place single dishes on the centre of the shelf. You may need to turn large items around during cooking.

Roasting

For best results we recommend open roasting using minimal fat or oil to prevent splashing.

It is not necessary to cover meat or poultry or wrap food in foil when roasting as this restricts the circulation of heat and will lead to extended cooktimes.

If you are using a roasting bag or cover chicken breast with foil, be prepared to allow an extra 10 - 15 minutes for each 1/2kg (1lb). When cooking large items such as turkeys, the use of foil may be required to prevent the breast becoming dry before the rest of the bird is fully cooked.

Condensation

Condensation may form on the appliance. This is quite normal and nothing to worry about. The condensation forms when heat and moisture are present, for example during cooking. Whenever possible try to make sure that food which contains a lot of moisture, for example casseroles, are covered. If you do notice any condensation, wipe it up straight away.

Oven cooking chart

These instructions are for cooking in the oven after it has been pre-heated for 20 minutes.

If you are cooking more than one tray of similar items, for example cakes or biscuits, swap the trays around during cooking. Or you can take the top tray out of the oven when the food is cooked and move the lower tray to the higher shelf to finish cooking.

Always leave at least one shelf position between shelves to allow heat to circulate.

The recommended shelf positions give the best results.

Put the dishes in the centre of the shelf.

You can change the gas marks and cooking times to suit your own tastes.

It is important to check that food is piping hot before serving.

Food	Gas mark	Shelf position	Approximate cooking time
Roasting meat: Beef	5	4	Rare: 20 mins. per ½kg (1lb) and 30 mins. Medium: 25 mins. per ½kg (1lb) and 25 mins. Well Done: 30 mins. per ½kg (1lb) and 30 mins.
Lamb	5	4	Medium: 25 mins. per ½kg (1lb) and 25 mins. Well Done: 30 mins. per ½kg (1lb) and 30 mins.
Pork and Veal	5	4	Medium: 30 mins. per ½kg (1lb) and 30 mins. Well Done: 35 mins. per ½kg (1lb) and 35 mins.

Thaw frozen joints thoroughly before cooking them.

Food	Gas mark	Shelf position	Approximate cooking time
Poultry:			
Chicken	5	4	20 mins. per ½kg (1lb) and 20 mins.
Turkey below 4.5kg (10lbs)	4	4	25 mins. per ½kg (1lb) and 25 mins.
over 4.5kg (10lbs)	4	4 or 5	15 mins. per ½kg (1lb) and 15 mins.
Duck and duckling	5	4	25 mins. per ½kg (1lb)
Stuffed poultry	Cook as above but calculate weight including stuffing.		
Thoroughly thaw frozen joints before cooking them.			
The times given above are for open roasting in a preheated oven. If you cover the food with foil or a lid allow an extra 10 - 15 minutes for each ½kg (1lb).			
Yorkshire pudding			
- large	7	1	25-30 mins.
- individual	7	1	15-25 mins.
Cakes:			
Christmas cake (8")	2	4	4 - 5 hours
Rich fruit, 180mm (7")	2	3	2¼-2½ hours
205mm (8")	2	3	2½-2¾ hours
Madeira, 180mm (7")	4	4	1 hour
Small cakes	5	1 & 3	15-25 mins.
Scones	7	1 & 3	10-20 mins.
Victoria sandwich			
180mm (7")	4	2 & 4	20-30 mins.
205mm (8")	4	2 & 4	20-35 mins.

Food		Gas mark	Shelf position	Approximate cooking time	
Pastries:	Plate tart (shortcrust)	6	1	25 -35 mins.	To help pastry brown on the underside cook on a metal plate, or if plates are flat and have no rim underneath, place on baking tray.
	Fruit pie (shortcrust)	6	1	25-35 mins.	
	Mince pies (flan pastry)	5	2 & 4	15-25 mins.	
Puddings:	Milk pudding	2	3	2 hrs.	
	Baked sponge pudding	4	3	45-60 mins.	
	Baked custard	3	3	50-60 mins.	
	Bread 0.45kg (1lb loaves)	8*	3	30-40 mins.	
	0.90kg (2lb loaves)	8*	3	30-40 mins.	
	Rolls and buns	8*	2	10-20 mins.	

* Note: When baking bread cook at gas mark 8 for 10 minutes before reducing to Gas mark 6 for remainder of cook time.

Note: You must soak dried beans then boil them in an open pan for 15 minutes before you add them to any dish.

Slow cooking

The slow cook setting gives a very low heat in the oven. It is particularly useful when cooking soups, stews and casseroles because the long slow cooking will make cheaper, tougher cuts of meat more tender.

You need to cook food at gas mark 6 for 30 minutes before you turn the oven down to a slow cook setting. This makes sure that the temperature of the food gets hot enough to start the food cooking.

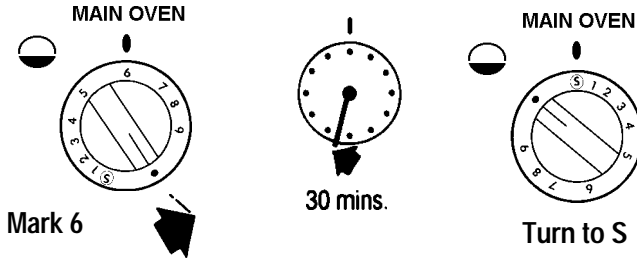

Some foods such as pastry and biscuits are not suitable for slow cooking because the temperature is too low.

Cover all food during cooking to prevent it from drying out. You can uncover food for the last half hour if it is normally served golden brown.

Food preparation-slow cooking

Joints of meat and poultry

- **Do not** cook meat joints over 2.7kg (6lb).
- **Do not** cook poultry over 2kg (4lb 8oz).
- Cook on the middle shelf of the oven or above.
- Cook stuffing separately.
- Cook for a minimum of 6 hours.
- Joints of pork must only be cooked if you can make sure, by using a meat thermometer, that an internal temperature of at least 88°C has been reached .
- For good air circulation always stand joints on a rack in a roasting tin or casserole.
- Thaw all frozen meat and poultry before cooking.
- Prime cuts of meat do not benefit from slow cooking.
- Remove excess fat and skin unless browned first.
- Cook for 30 minutes at gas mark 6, then reduce to the slow cook setting.

Soups, casseroles and stews

- **Do not** cook casseroles over 2.7kg (6lb).
- Bring to the boil on the hotplate then cook on slow cook.
- Cook in the middle of the oven or above.
- Cover food with a tight fitting lid or tin foil.

Vegetables

- Cut into small pieces.
- Dried beans must be pre-soaked then boiled in an open pan for 15 minutes before adding to any dish.
- Place vegetables under meat in casseroles.
- Cover food with a tight fitting lid or tin foil.
- Cook for 30 minutes at gas mark 6, then reduce to the slow cook setting.

Milk puddings

- Cover the cereal with boiling water and allow to stand for 30 minutes.
- Drain and make the pudding in the usual way.
- Cook for 30 minutes at gas mark 6, then reduce to the slow cook setting.

General points for slow cooking

Frozen foods

Thaw thoroughly before cooking.

Thickening

Toss meat in flour for casseroles. Alternatively blend cornflour with water and add it at the end of cooking.

Flavouring

Flavours are retained because there is little evaporation. Adjust at the end of the cooking time.

Liquid

Reduce normal liquid quantities slightly as there is little evaporation during cooking.

Milk and milk products, for example cream

Add towards the end of the cooking to prevent curdling.

Reheating

Left over food should be cooled quickly and refrigerated.

Do not reheat food using the slow cook setting. Reheat food conventionally or in a microwave. Food must only be reheated once.

Care and cleaning

For your safety

For hygiene and safety reasons you must keep this gas appliance clean. A build up of fat or other foodstuff could cause a fire.

Try to mop up spills and splashes as soon as they happen. But be careful as parts of the cooker will be **hot**.

Do not use any polishes, caustic cleaners, abrasives, washing soda or soap except those recommended.

Please note: If we recommend you use hot soapy water we mean hot water with washing up liquid in it and not any other cleaning product.

If you own a dishwasher please read the operating instructions for the machine before you wash any part of your appliance in it.

Clean your appliance regularly using a cloth that has been wrung out in hot soapy water. Rinse and polish it dry using a soft cloth.

When you remove parts of your appliance for cleaning **do not** plunge them into water whilst they are very hot as this may damage the finish of the parts.



The hotplate

Clean the hotplate top using a mild abrasive such as 'Cif'. Take care not to damage the spark electrodes. If the spark electrodes are damaged the burners will not light.

You can remove the pan supports, burner caps and burner crowns to clean them. Again take care not to damage the spark electrodes.

If any food spills during cooking you can place the pan on another burner to finish cooking. Then you can remove the dirty parts and clean them before the spill 'burns on'.

You can wash the removable parts in very hot soapy water. You may use mild abrasives. Make sure that the electrode and the hole and slots in the crown are not blocked with food or cleaning materials.

Clean the burner crowns by soaking them in very hot soapy water. You can remove any stubborn stains by scouring with a soap filled pad such as 'Brillo'. If you look after the burner crowns in this way they will stay reasonably clean. However the surface will dull with time. Aluminium based saucepans can leave shiny metal marks on the pan supports. Clean the pan supports regularly to remove the marks using a mild abrasive like 'Cif' with a soft scourer. For more stubborn marks you can use a soap-filled pad such as 'Brillo'.

After cleaning the appliance parts, dry them thoroughly before you put them back.

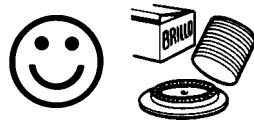

When replacing hotplate burner parts

1. Crown to body (**Do not** try to force the crown on to the body).

Make sure that the hole in the crown is over the electrode. Check that the two longer location pegs sit in the slots in the body. When the crown is in this position let it fall freely on to the body. Check that the crown can be moved slightly from side to side.

2. Cap to crown

Place cap centrally on the top of the crown (enamel side up). Move sideways and front to back to check the cap is properly fitted.

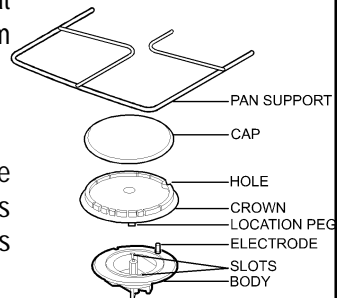

3. Check for ignition

If a burner will not light then you need to check the crown and cap positions.

The grill

Do not clean the grill burner itself.

The burner is designed to be self cleaning. Cleaning the grill may cause the holes in the burner to become blocked preventing it from operating correctly.

Please note that due to the nature of stainless steel the grill burner may tarnish through use over a period of time. This is quite normal and is not a fault on the appliance.

Clean the area around the grill frequently using hot soapy water.

After use you can soak the pan for a few minutes and then clean it using mild abrasives or a soap filled pad such as 'Brillo'.

Clean the grill shelf using hot soapy water. Mild abrasives can be used if necessary.

The oven

The inside of the oven is finished in vitreous enamel. You should clean the oven regularly using hot soapy water and mild abrasives or a soap filled pad such as 'Brillo'. If you use any oven cleaners they must have the Vitreous Enamel Development Council (VEDC) seal of approval. Follow the instructions on the cleaning agent and protect the oven burner with foil to prevent it becoming blocked.

General

Clean the oven shelves and the oven door while they are still slightly warm. This way you can easily remove any splashes and spills. Wipe with a cloth that has been wrung out in hot soapy water. You may use mild abrasives.

Installing the appliance

For your safety

This appliance must be installed and serviced by a competent person as stated in the Gas Safety (Installation & Use) regulations current editions.

It is important that the appliance is suitable for your gas supply. Your installer should check the rating plate.

Ensure that a stability bracket is fitted.

Location

For your safety

The use of a gas cooking appliance results in the production of heat and moisture in the room in which it is installed. Ensure that the kitchen is well ventilated: keep natural ventilation holes open or install a mechanical ventilation device (mechanical extractor hood).

Prolonged intensive use of the appliance may call for additional ventilation, for example opening of a window, or more effective ventilation, for example increasing the level of mechanical ventilation where present.

For further details see page 32.

Positioning

The diagram shows how close to the appliance cupboards, shelves, curtains and so on can be fitted. Check the diagram and carefully read the instructions to make sure your appliance is fitted safely. If you are in doubt your installer will give you advice.

- Do not fit any materials which may catch fire for example wood or curtains behind the appliance.

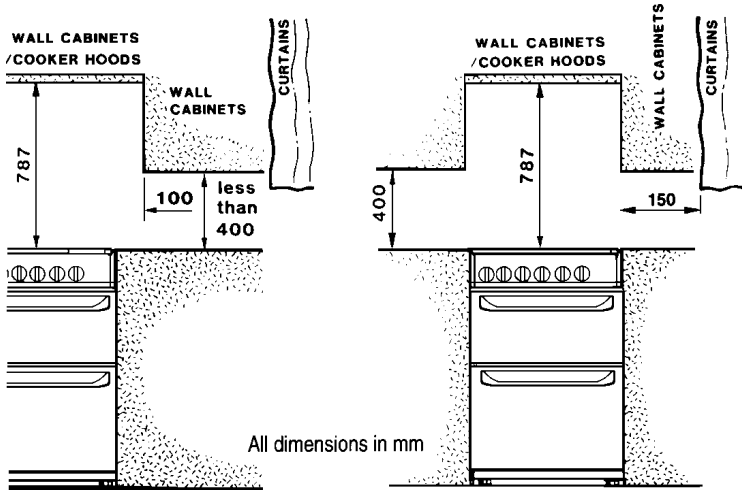

- Base units which are higher than the hotplate must be 100mm away.
- If a cooker hood is fitted read the cooker hood installation instructions.
- We recommend that cabinets fitted next to or above the cooker meet British Standards. Your installer will give you advice if you are not sure.

Appliance dimensions

Overall Height :	902mm-920mm (adjusted by four screw feet)
Width:	498mm
Depth:	600mm (to front of door panel)

General information

For your safety

Do not block any of the appliance vents.

Never line any part of the appliance with foil.

Do not let items which can catch fire or electric mains leads such as kettle flexes trail over any part of the appliance.

Moving your appliance

You may damage some soft or badly fitted floor coverings when you move the appliance. The floor covering under the appliance should be securely fixed so it does not ruck up when you move the appliance across it. Alternatively you could remove the floor covering.

To move the appliance open the grill door. Raise the appliance off its front feet by lifting it from inside the grill. Pull the appliance forward. When you replace the appliance push it back to the stop and make sure there is the same gap at each rear corner.

The battery

The battery for the ignition will usually last for many months. If the ignition system doesn't work you probably need to replace the battery.

The battery is at the base of the appliance on the left-hand side of the front. When you need to replace the battery, open the main oven door, lift up the battery holder lid and replace the battery as shown in the diagram. The battery you need to replace is AA size.

When you fit the new battery, make sure the positive end (marked with a + sign) is next to the (+) sign on the battery holder. Close the lid of the battery holder.

You can light the burners with a match until you have time to change the battery.

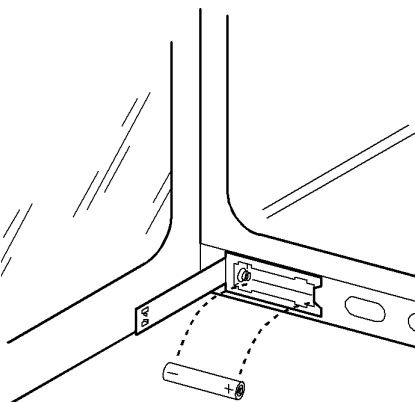

For your safety

Do not try to disconnect the appliance from the gas supply if the supply pipe does not have a bayonet connection, as described in the installation instruction. If this is the case contact the person who installed the appliance.

What is wrong and why?

We strongly recommend that you carry out the following checks on your appliance before calling a Service Engineer.

Problem

The oven, grill or hotplate will not light.

Check

- If only the hotplate burners will not light make sure that the burner parts have been placed correctly. See instructions on page 21.
- If you cannot hear any sparking or the sparking is slow when you press the ignition button the battery probably needs replacing. For instructions on how to do this see page 25. You can light the burners with a match until you have time to change the battery.
- Check that there is not a problem with your gas supply. You can do this by making sure that other gas appliances such as your central heating or gas fire are working.

Problem

Food is cooking too quickly or too slowly.

Check

- Check that you are using the recommended gas marks and shelf positions. See page 15. Be prepared to adjust the gas mark up or down to achieve the results you want.

Problem

The oven is not cooking evenly.

Check

- Check that the appliance is installed properly and is level.
- Check that you are using the recommended temperatures and shelf positions.

Problem

Having difficulty cleaning any part of the appliance.

Check

- Check that the instructions for care and cleaning, beginning on page 20 are being followed.

Service and spare parts

In the event of your appliance requiring service, or if you wish to purchase spare parts please contact your local Service Force Centre by telephoning:-

08705 929929

Your telephone call will be automatically routed to the Service Force Centre covering your post code area.

For the address of your local Service Force Centre and further information about Service Force, please visit the website at www.serviceforce.co.uk

Before you call an engineer check through the information under the heading 'What is wrong and why?'

**In-guarantee customers should ensure that the checks under the heading 'What is wrong and why?' have been made as the engineer will make a charge if the fault is not a mechanical or electrical breakdown.
Please note that it is necessary to provide proof of purchase for any in-guarantee service calls.**

When you report a problem try to describe the nature of the fault. Always give your appliance's full name, model and serial number. Make a note of this information in this space:

Name:

Model Number:

Serial Number:

P.N.C. Number:

For your safety

Maintenance must only be carried out by a competent /qualified person. **Do not** try to repair or alter/modify the appliance yourself as this could be dangerous.

We recommend that your appliance has an annual gas safety check carried out by our approved service organisation.

Customer Care Department

For general enquiries concerning your Parkinson Cowan appliance or further information on products, you are invited to contact our Customer Care Department by letter or telephone as follows:

Customer Care Department
Parkinson Cowan
55-77 High Street
Slough
Berkshire
SL1 1DZ

Tel: 08705 950950 *

* calls to this number may be recorded for training purposes.

For Customer Service in Ireland please contact us at the address below:

Parkinson Cowan
Electrolux Group (Irl) Ltd
Long Mile Road
Dublin 12
Republic of Ireland

Tel: +353 (0)1 4090755

Email: service.eid@electrolux.ie

The Gas Consumers' Council

The Gas Consumers' Council (GCC) is an independent organisation which protects the interests of gas users.

If you need advice, you will find the telephone number in your local telephone directory under Gas.

INSTALLATION INSTRUCTIONS

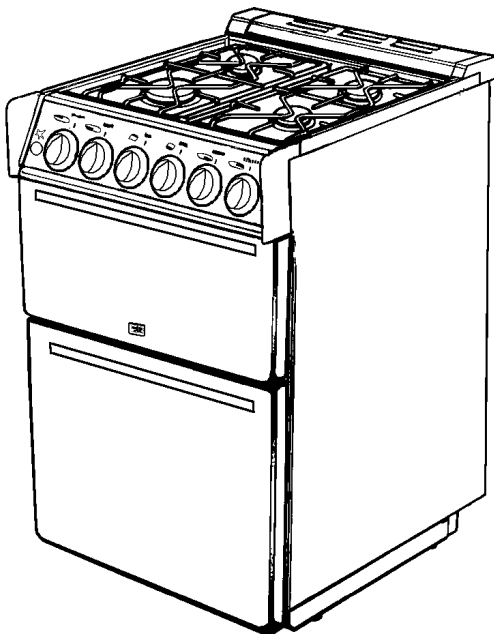

Serial number on front frame. Rating Plate on top rear of panel.

Please note that the handle and pan supports may differ in type and shape from that shown in the diagram.

For your safety

Where applicable Natural Gas and L.P. Gas versions of this appliance are available.

Check that this model is suitable for the type of supply available.

In the interest of safety this appliance must be installed and/or serviced by a competent person, as stated in the Gas Safety (Installation and Use) Regulations Current Editions.

TECHNICAL DATA

DIMENSIONS

	<i>Height</i>	<i>Width</i>	<i>Depth</i>
Height to hotplate	907mm (nominal)	498mm	600 mm (to front of door panel)
Space for fixing at hotplate level		2mm minimum clearance	
Minimum space above hotplate	787mm (If a cooker hood is fitted refer to the cooker hood installation instructions).		
Space for fixing above hotplate level	See important note "Location of Appliance", page 33.		
Weight of appliance	50.4kg.		
Minimum distance from rear wall	1mm		

CONNECTIONS

Gas	Rear left hand side of appliance at hotplate level. Rc½ (½" B.S.P. female).
Electric	None

IGNITION

Battery	1.5 Volt AA size
---------	------------------

GRILL

	<i>Natural Gas</i>	<i>L.P. Gas</i>
Heat Input	2.7kW (9215 Btu/h)	2.45kW (176g/h)
Injector Marking	121	78

HOTPLATE

	<i>Natural Gas</i>			
	R.H.F.	R.H.R.	L.H.R.	L.H.F.
Heat Input	1.0kW (3412 Btu/h)	1.9kW (6483 Btu/h)	1.9kW (6483 Btu/h)	2.9kW (9895 Btu/h)
Injector Marking	070	096	096	119
	<i>L.P. Gas</i>			
Heat Input	1.0kW (71.8 g/h)	1.9kW (136.5 g/h)	1.9kW (136.5 g/h)	2.8kW (194.0 g/h)
Injector Marking	050	071	071	086

MAIN OVEN

	<i>Natural Gas</i>	<i>L.P. Gas</i>
Heat Input	2.4kW (8189Btu/h)	2.4kW (172.4 g/h)
Injector Marking	108	78
Thermostat By-pass Marking	69	78

GENERAL

Ignition	H. T. Spark
Spark Gap	3-4mm

GAS CATEGORY

COUNTRIES OF DESTINATION

CAT. I_{2H}

GB, IE

CAT. I₃₊

GB, IE

IMPORTANT - SAFETY REQUIREMENTS

This appliance must be installed in accordance with the Gas Safety (Installation and Use) Regulations Current Editions. Detailed recommendations are contained in the following British Standard Codes of Practice - BS. 6172, BS.5440: Part 2 and B.S.6891. All British Standards must be 'Current Editions'.

PROVISION FOR VENTILATION

This appliance is not connected to a combustion products evacuation device. It shall be installed and connected in accordance with the current installation regulations. Particular attention shall be given to the relevant requirements regarding ventilation.

The room containing the appliance should have an air supply in accordance with BS. 5440: Part 2 Current Edition. All rooms require an openable window or equivalent and some rooms will require a permanent vent as well. For room volumes up to 5m³ an air vent of 100cm² is required: for room volumes between 5m³ and 10m³ an air vent of 50cm² is required. If the room has a door that opens directly to the outside, no air vent is required. For room volumes that exceed 11m³ no air vent is required. If there are other fuel burning appliances in the same room, BS.5440: Part 2 Current Edition should be consulted to determine the requisite air vent requirements.

Prolonged intensive use of the appliance may call for additional ventilation, for example opening a window, or more effective ventilation, for example increasing the level of mechanical ventilation where present.

LOCATION OF APPLIANCE

This appliance must not be installed in a bed-sitting room of volume less than 20m³ or in a bathroom, shower room or garage. It is essential that the appliance is positioned as stated below (see Fig. 1) i.e. shelves, wall cabinets and cooker hoods must be fitted a minimum of 787mm directly above the top of hotplate and 400mm above the hotplate when fitted in line with the outside of the appliance. If the units are intended to be fitted adjacent to the appliance but less than 400mm above the hotplate, then a minimum space of 100mm must be maintained between the sides of the unit and the appliance (see Fig.1a). Curtains must not be fitted immediately behind the appliance or within 150mm of the sides of the hotplate. If fitted next to or between two base units a minimum space of 1mm must be left between each unit and the sides of the appliance. The hotplate must be set to minimum of 7mm above the adjacent units. (Note: The levelling feet fitted to the appliance will achieve a nominal height of 907mm -5+13mm). Base units not meeting the above conditions must be a minimum of 100mm away from the hotplate. L.P.G. cookers MUST NOT be installed below ground level, i.e in a basement, or aboard any boat, yacht or other vessel.

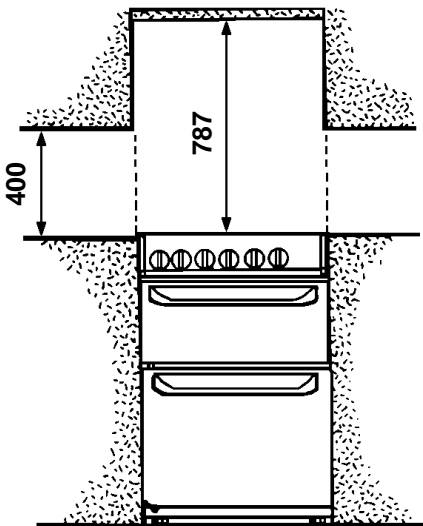

Fig.1

All dimensions in mm

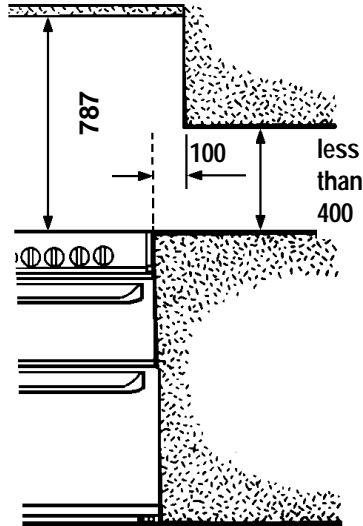

Fig.1a

INSTALLATION

1. PARTS REQUIRED

The loose hotplate parts and battery are packed in the polystyrene fitment on top of the hotplate.

2. LEVELLING THE APPLIANCE

Adjustable levelling feet at the front and at the rear are provided on the base of the appliance.

Adjustment to suit floor conditions is obtained by rotating in or out the hexagonal feet from the underside of the appliance.

A spirit level should be placed on one of the oven shelves to confirm that the appliance is correctly levelled.

3. FITTING THE STABILITY BRACKET

It is recommended that if the appliance is to be installed with a flexible supply pipe a stability bracket (SK.4729.A) is fitted and is available from your supplier (see Important Safety Requirements, Page 32). These instructions should be read in conjunction with the leaflet packed with the stability bracket.

1. Place the appliance in its intended position and level appliance.
2. Mark off 250mm from the left hand side of the appliance as shown in dimension 'A', Fig 3a. This is the centre line of the fixing bracket.
3. Draw a line 100mm from the front edge of the levelling feet (see Fig 3a) and remove appliance from its position. Mark off dimension 'B' (see Fig 3a) back from this line on the centre line of the bracket to locate the front edge of the lower bracket. Fix lower bracket (with two fixing holes) to the floor then measure the height from floor level to engagement edge on back of appliance, dimension 'C' of Fig. 3b.
4. Assemble upper bracket to lower bracket so that underside of bracket is dimension 'C' +3mm above floor level. (see Fig. 3b).

Reposition appliance and check that top bracket engages into appliance back as shown in Fig. 3b.

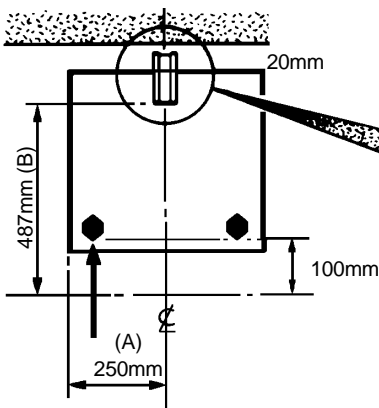

Fig.3a

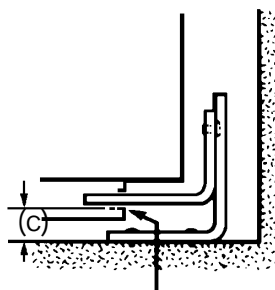

Fig.3b

4. CONNECTING TO GAS

This appliance is designed to be installed with an appliance flexible connection only. Supply piping should not be less than R³/₈. Connection is made to the Rc¹/₂ (½" B.S.P.) female threaded entry pipe located just below the hotplate level on the rear left hand side of the appliance. **NOTE: ONLY LIQUID SEALANTS TO BE USED WHEN INLET GAS PIPE IS FITTED I.E.: DO NOT USE P.T.F.E. SEALANT TAPE.**

Carry out a gas tightness test after connecting to the gas supply.

The gas bayonet connector must be fitted in the shaded area indicated in Fig. 3. Take into account that it must be possible to pull the appliance forward sufficiently. The hose must not get caught on the stability bracket.

IMPORTANT: FLEXIBLE TUBING USED MUST COMPLY WITH BS. 669 CURRENT EDITION.

L.P.G. FLEXIBLE CONNECTIONS MUST BE OF A TYPE SUITABLE FOR L.P.G. AND CAPABLE OF OPERATION UP TO 50 mbar AND TO CARRY A RED STRIPE, BAND OR LABEL.

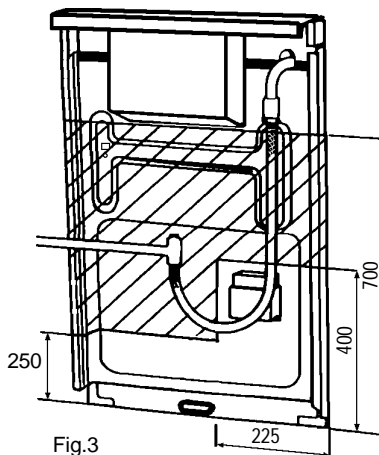

Fig.3

All dimensions in mm

5. FITTING THE BATTERY

1. The battery is located on the left hand side of the front plinth.
2. To gain access to the battery, open the main oven door and lift up the battery holder lid.
3. Fit the new battery ensuring (+) terminal is next to the (+) sign on the battery. See Fig.4.
4. Close the lid of the battery holder

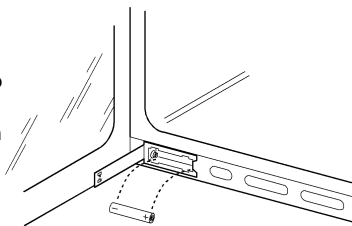

Fig.4

6. PRESSURE TESTING

1. The oven injector is used as a pressure test point.
Remove the oven furniture. Remove oven burner box retaining clips (one spring clip from each side) and remove box front cover. Replace one clip back into the right hand side of the burner box. Remove oven burner by removing the spring clip from the right hand side of the oven burner and slide burner off injector, whilst easing it forward and taking care not to strain the F.S.D. phial.
2. Connect the pressure gauge to the oven injector.
3. Check the supply pressure by turning the thermostat on and one hotplate tap full on and light the appropriate burner. The pressure should be either:-
 - (i) For Natural Gas 20mbar
 - (ii) For LP.Gas The pressure must be set to 28 mbar for use on butane or 37 mbar for use on propane.
4. Turn off the taps, disconnect the pressure gauge and replace oven burner and cover, ensuring that the F.S.D. phial is correctly located into the bracket on the burner.
5. Check operation of oven.

7. CHECKING THE GRILL

Place the grill pan containing the grid, with the handle attached, into the grill compartment. Light the grill burner by turning the grill tap full on and pressing the ignition button on the fascia panel. As soon as the burner is lit the button can be released.

8. CHECKING THE HOTPLATE

Fit the burner crowns and caps ensuring that they are correctly seated. Fit the pan supports. Check each of the hotplate burners in turn by turning the hotplate tap to it's full on position and pressing the ignition button. As soon as the burners are lit the button can be released.

9. CHECKING THE MAIN OVEN

1. Turn the oven thermostat knob to Mk 9 and press the ignition button. As soon as the burner is alight the button can be released.
2. There should now be a low gas rate to the burner, which is the F.S.D. by pass rate.
3. When the F.S.D. phial has heated up it opens the F.S.D. valve which allows the main gas supply to the oven burner.
4. After 1 minute check that the flame covers the full width of the burner and is stable.
5. Set the oven control to Mk 2, close the oven door and check that after about 10 minutes the flame size has reduced.
6. Turn off the control and check that the oven flames go out.

GENERAL NOTE

Instruct the user on how to use the appliance and its ignition system. Refer the user to the wording in the inside cover which gives advice on the safe operation of the appliance.

NOTES

NOTES

SG 305 - 311661800

Contents Check List

Note:

If you require replacements of the item listed below please contact your local Service Force Centre quoting the relevant part number.

The loose contents of this pack include:-

No. OFF	DESCRIPTION
2	Oven Shelves
1	Guarantee Card
1	Grill Pan (311409401)
1	Grill Pan Grid (311419801)
1	Grill Pan Handle (311468100)
1	Grill Shelf
4	Burner Crowns
4	Burner Caps
2	Pan Supports
1	Battery

Note:

If you require an additional handle for your grill pan, this can be ordered from your local Service Force Centre by quoting part number 311479800\6.

IMPORTANT NOTICE

In line with our continuing policy of research and development, we reserve the right to alter models and specifications without prior notice.

This instruction booklet is accurate at the date of printing, but will be superseded if specification or appearance are changed.

<i>Description</i>	<i>No. Off</i>	<i>Maker's Part Number</i>
Burner Cap - Rapid	1	354000610
Burner Cap - Normal	2	354000609
Burner Cap - Simmer	1	354000608
Burner Crown - Rapid - N.G.	1	354004707
Burner Crown - Rapid - L.P.G.	1	354004707
Burner Crown - Normal	2	354004602
Burner Crown - Simmer	1	354004502
Pan Support	2	311645701

NOTE : Failure to use manufacturers original spares could negate normal BSI approval of the product

PARKINSON COWAN
55 - 77 HIGH STREET,
SLOUGH,
BERKSHIRE,
SL1 1DZ.
TELEPHONE 0870 5 950950

Part Number:311661800



© Electrolux plc 2003

 **From the Electrolux Group.** The world's No.1 choice.

The Electrolux Group is the world's largest producer of powered appliances for kitchen, cleaning and outdoor use. More than 55 million Electrolux Group products (such as refrigerators, cookers, washing machines, vacuum cleaners, chain saws and lawn mowers) are sold each year to a value of approx. USD 14 billion in more than 150 countries around the world.