



user manual

Ceramic glass hob

EHS 60020 K

We were thinking of you
when we made this product



Welcome to the world of Electrolux

Thank you for choosing a first class product from Electrolux, which hopefully will provide you with lots of pleasure in the future. The Electrolux ambition is to offer a wide variety of quality products that make your life more comfortable. You will find some examples on the cover in this manual. Please take a few minutes to study this manual so that you can take advantage of the benefits of your new machine. We promise that it will provide a superior User Experience delivering Ease-of-Mind. Good luck!

Contents

Safety instructions	5
Description of the Appliance	7
Operating the appliance	9
Tips on cooking and frying	12
Cleaning and care	15
What to do if ...	17
Disposal	19
Installation Instructions	20
Assembly	22
Guarantee/Customer Service	26
Service and Spare Parts	29

The following symbols are used in this user manual:

-  Important information concerning your personal safety and information on how to avoid damaging the appliance.
-  General information and tips
-  Environmental information



Safety instructions



Please comply with these instructions. If you do not, any damage resulting is not covered by the warranty.



This appliance conforms with the following EU Directives:

- 73/23/EEC dated 19.02.1973 Low Voltage Directive
- 89/336/EEC dated 03.05.1989 EMC Directive inclusive of Amending Directive 92/31/EEC
- 93/68/EEC dated 22.07.1993 CE Marking Directive

Correct use

- This appliance should be used only for normal domestic cooking and frying of food.
- The appliance must not be used as a work surface or as a storage surface.
- Additions or modifications to the appliance are not permitted.
- Do not place or store flammable liquids, highly inflammable materials or fusible objects (e.g. plastic film, plastic, aluminium) on or near the appliance.

Child safety

- Small children must be kept away from the appliance.
- Only let bigger children work on the appliance under supervision.

General safety

- The appliance may only be installed and connected by trained, registered service engineers, or competent persons.
- Built-in appliances may only be used after they have been built in to suitable built-in units and work surfaces that meet standards.
- In the event of faults with the appliance or damage to the glass ceramic (cracks, scratches or splits), the appliance must be switched off and disconnected from the electrical supply to prevent the possibility of an electric shock.
- Repairs to the appliance must only be carried out by trained registered service engineers.

Safety during use

- Remove stickers and film from the glass ceramic.
- There is the risk of burns from the appliance if used carelessly.
- Cables from electrical appliances must not touch the hot surface of the appliance or hot cookware.
- Overheated fat and oil can ignite quickly. When cooking with fat or oil (e.g. frying chips) do not leave the appliance unattended.
- Switch the cooking zones off after each use.

Safety when cleaning

- For cleaning, the appliance must be switched off and cooled down.
- For safety reasons, the cleaning of the appliance with steam jet or high-pressure cleaning equipment is not permitted.

How to avoid damage to the appliance

- The ceramic glass can be damaged by objects falling onto it.
- The edge of the ceramic glass can be damaged by being knocked by the cookware.
- Cookware made of cast iron, cast aluminium or with damaged bottoms can scratch the ceramic glass if pushed across the surface.
- Objects that melt and things that boil over can burn onto the ceramic glass and should be removed straightaway.
- To avoid damaging cookware and glass ceramics, do not allow saucepans or frying pans to boil dry.
- Do not use the cooking zones with empty cookware or without cookware.

Description of the Appliance

Cooking surface layout

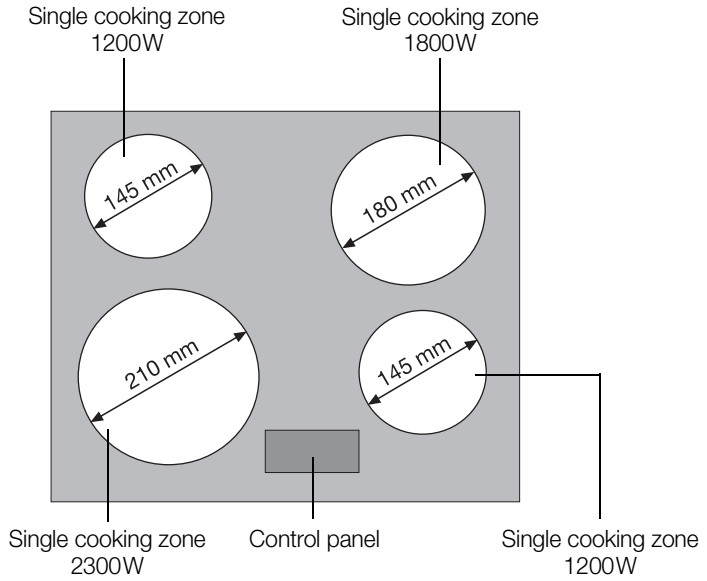

Control panel layout

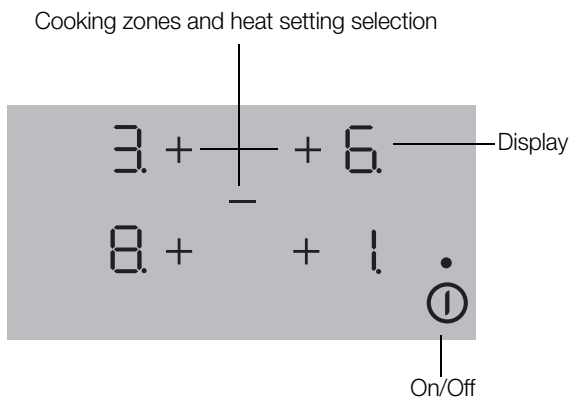





Touch Control sensor fields

The appliance is operated using the Touch Control sensor fields. Functions are controlled by touching sensor fields and confirmed by displays.

Touch the sensor fields from above, without covering other sensor fields.

Sensor field		Function
ⓘ	On / Off	Switches appliance on and off
+	Increase settings	Select cooking zone Increases heat setting
-	Reduce settings	Reduces heat setting

Displays

Display	Description
	Cooking zone is switched off
	Heat settings
	Fault
	Residual heat
	Child safety device

Residual heat indicator







Warning! Risk of burns from residual heat. After being switched off, the cooking zones need some time to cool down. Look at the residual heat indicator .





Residual heat can be used for melting and keeping food warm.

Operating the appliance

Switching the appliance on and off

	Control panel	Display
Switch on	Touch  for 2 seconds.	 / Decimal point flashes
Switch off	Touch  for 1 second	 / none

Selecting the cooking zone

	Control panel	Display
Select	Touch 	 Decimal point illuminates











The decimal point is displayed by the selected cooking zone. Then a heat setting must be set for this cooking zone within 6 seconds, otherwise it must be re-selected.

Selecting the heat setting



After selecting the cooking zone, briefly release the sensor field .

	Control panel	Display
Increase	Touch 	 to 
Decrease	Touch 	 to 
Switch off	Touch  and  at the same time	



After 6 seconds with no input the selection is cancelled and the decimal point goes out. To set the required cooking zone again, make another selection.

Using the child safety device

The child safety device prevents unintentional use of the appliance.



The child safety device can only be activated immediately after the appliance has been switched on.

Switching on the child safety device

Step	Control panel	Display
1.	① Switch on appliance. (Do not set a heat setting.)	/ (if hot)
2.	Touch — for 5 seconds	is displayed.

Appliance switches off.



To override or switch the child safety device off successfully, the steps must be performed immediately one after the other. No other sensor fields must be touched between the steps described.

Overriding the child safety device

The child safety device can be switched off in this way for a single cooking session; it remains activated afterwards.

Step	Control panel	Display
1.	① Switch appliance on	/ (if hot)
2.	Touch the two + of the front cooking zones at the same time	or Decimal points flash

Until the appliance is next switched off, it can be used as normal.

Switching off the child safety device

Step	Control panel	Display
1.	① Switch appliance on	/ (if hot)
2.	Touch — for 5 seconds	or Decimal points flash

Appliance switches off.

Safety cut-out

Cooking surface

- If after switching on the appliance a heat setting is not set for a cooking zone within approx. 10 seconds, the appliance automatically switches itself off.
- If one or more sensor fields are touched for longer than approx. 10 seconds, the cooking surface is automatically switched off. **Er03** flashes on the display or changes to **H** if there is still residual heat.
- If all cooking zones are switched off, the cooking surface automatically switches itself off after approx. 10 seconds.

Control panel



Moisture (e.g. a wet cloth) or liquid boiling over onto the control panel switches all cooking zones off.

Cooking zones

- If one of the cooking zones is not switched off after a certain time, or if the heat setting is not modified, the relevant cooking zone switches off automatically. **H** is displayed.

Heat setting	Switches off after
1 - 2	6 hours
3 - 4	5 hours
5	4 hours
6 - 9	1.5 hours

Tips on cooking and frying



Information about acrylamides

According to the latest scientific research, intensive browning of food, especially in products containing starch, may present a health risk due to acrylamide. Therefore we recommend cooking at low temperatures and not browning foods too much.

Cookware

- You can recognise good cookware from the bottoms of the pans. The bottom should be as thick and flat as possible.
- Cookware made of enamelled steel or with aluminium or copper bottoms can leave discolourations on the ceramic glass surface which are difficult or impossible to remove.

Energy saving



Always place cookware on the cooking zone before it is switched on.



If possible, always place lids on the pans.



Switch cooking zones off before the end of the cooking time, to take advantage of residual heat.



Bottom of pans and cooking zones should be the same size.

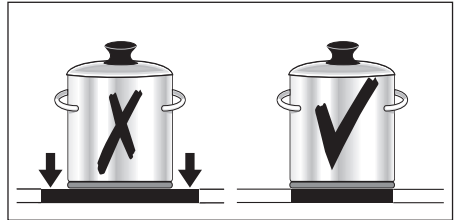
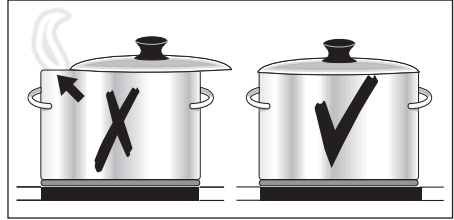

Examples of cooking applications

The information given in the following table is for guidance only.

Heat setting	Cooking process	suitable for	Cook time	Tips/Hints
0		Residual heat setting, Off position		
1	Keeping food warm	Keeping cooked foods warm	as required	Cover
1-2	Melting	Hollandaise sauce, melting butter, chocolate, gelatine	5-25 mins.	Stir occasionally
	Solidifying	Fluffy omelettes, baked eggs	10-40 mins.	Cook with lid on
2-3	Simmering	Simmering rice and milk-based dishes Heating up ready-cooked meals	25-50 mins.	Add at least twice as much liquid as rice, stir milk dishes part way through cooking
3-4	Steaming Braising	Steaming vegetables, fish Braising meat	20-45 mins.	With vegetables add only a little liquid (a few table-spoons)
4-5	Boiling	Steaming potatoes	20-60 mins.	Use only a little liquid, e. g.: max. $\frac{1}{4}$ l water for 750 g of potatoes
		Cooking larger quantities of food, stews and soups	60-150 mins.	Up to 3 l liquid plus ingredients
6-7	Gentle frying	Frying escalope, veal cordon bleu, cutlets, rissoles, sausages, liver, roux, eggs, pancakes, doughnuts	as required	Turn halfway through cooking
7-8	Heavy frying	Hash browns, loin steaks, steaks, Flädle (pancakes for garnishing soup)	5-15 mins. per pan	Turn halfway through cooking
9	Boiling Searing Deep frying	Boiling large quantities of water, cooking pasta, searing meat (goulash, pot roast), deep frying chips		

Cleaning and care



Take care! Risk of burns from residual heat.



Important Sharp objects and abrasive cleaning materials will damage the appliance. Clean with water and washing up liquid.



Important Residues from cleaning agents will damage the appliance. Remove residues with water and washing up liquid.

Cleaning the appliance after each use

1. Wipe the appliance with a damp cloth and a little washing up liquid.
2. Rub the appliance dry using a clean cloth.

Removing deposits

1. Place the scraper on the glass ceramic surface at an angle.
2. Remove residues by sliding the blade over the surface.
3. Wipe the appliance with a damp cloth and a little washing up liquid.
4. Rub the appliance dry using a clean cloth.

Type of dirt	Remove		
	immediately	when the appliance has cooled down	using
sugar, food containing sugar	yes	---	a scraper* cleaner for glass ceramic or stainless steel*
plastics, tin foil	yes	---	
limescale and water rings	---	yes	
fat splashes	---	yes	
shiny metallic discolouration	---	yes	

*Scrapers and cleaners for glass ceramic and stainless steel can be purchased in specialist shops, supermarkets, the parts department of your local Service Force Centre or from www.shop.electrolux.co.uk



Remove stubborn residues with a cleaner for glass ceramic or stainless steel.



Scratches or dark stains on the glass ceramic that cannot be removed do not however affect the functioning of the appliance.

What to do if ...

Problem	Possible cause	Remedy
The cooking zones are not functioning.	No cooking zone selected	Select cooking zone within 10 seconds of switching on (Decimal point lights up)
The cooking zones cannot be selected / Appliance does not react to the control panel input	More than 10 seconds has passed since the appliance was switched on	Switch on the appliance again. Select cooking zone within 10 seconds of switching on
	The child safety device is activated (L)	Deactivate the child safety device (See section "Child safety device")
	The sensor fields are partly covered by a damp cloth or with liquid	Remove the cloth or the liquid
The residual heat indicator is not displaying anything	Safety cut-out has been triggered	Switch on the appliance again
	The cooking zone was only on for a short time and is therefore not hot	If the cooking zone is supposed to be hot, call your local Service Force Centre.
Er03 is displayed	Several sensor fields were touched at the same time	Only touch one sensor field
Er21 is displayed	Safety cut-out due to overheating.	Let the appliance cool down. Remove cookware.
Er25 is displayed (only for 10 seconds)	Appliance is incorrectly connected	Disconnect the appliance from the electrical supply and have it connected properly
Er40 is displayed	The overvoltage protector has been activated (for an incorrect connection see above Er25 or for overheating of the electronic components see Er21)	Separate the appliance from the mains for a few minutes (remove the mains fuse). Let the appliance cool down.



In the event of any other fault codes that arise, disconnect the appliance from the electrical supply for a few seconds (Take out the fuse from the house's wiring system). If the fault code is displayed again, please call your local Service Force Centre and report the fault code.

If you are unable to remedy the problem by following the above suggestions, please contact your local Service Force Centre.



Warning! Repairs to the appliance are only to be carried out by qualified service engineers. Considerable danger to the user may result from improper repairs.



If the appliance has been operated incorrectly, the visit from the service technician or dealer may not take place free of charge, even during the warranty period.

Disposal



Packaging material

The packaging materials are environmentally friendly and can be recycled. The plastic components are identified by markings, e.g. >PE<, >PS<, etc. Please dispose of the packaging materials in the appropriate container at your local waste disposal facilities.



Old appliance

The symbol  on the product or on its packaging indicates that this product may not be treated as household waste. Instead it shall be handed over to the applicable collection point for the recycling of electrical and electronic equipment. By ensuring this product is disposed of correctly, you will help prevent potential negative consequences for the environment and human health, which could otherwise be caused by inappropriate waste handling of this product. For more detailed information about recycling of this product, please contact your local city office, your household waste disposal service or the shop where you purchased the product.

Installation Instructions

Safety instructions

The laws, ordinances, directives and standards in force in the country of use are to be followed (safety regulations, proper recycling in accordance with the regulations, etc.)

Installation may only be carried out by a qualified electrician.

The minimum distances to other appliances and units are to be observed.

Anti-shock protection must be provided by the installation, for example drawers may only be installed with a protective floor directly underneath the appliance. The cut surfaces of the worktop are to be protected against moisture using a suitable sealant.

The sealant seals the appliance to the work top with no gap.

The sealant seals the appliance to the work top with no gap.

Do not use silicon sealant between the appliance and the work top.

Avoid installing the appliance next to doors and under windows. Otherwise hot cookware may be knocked off the rings when doors and windows are opened.



WARNING!

Risk of injury from electrical current.

- The electrical mains terminal is live.
- Observe connection schematic.
- Observe electrical safety rules.
- Ensure anti-shock protection through correct installation by a qualified electrician.

- The appliance must be connected to the electrical supply by a qualified electrician.



IMPORTANT!

Risk of injury from electrical current.

Loose and inappropriate plug and socket connections can make the terminal overheat.

- Have the clamping joints correctly installed by a qualified electrician.
- Use strain relief clamp on cable.
- In the event of single-phase or two-phase connection, the appropriate mains cable of type H05BB-F Tmax 90°C (or higher) must be used.
- If this appliance's mains cable is damaged, it must be replaced by a special cable (type H05BB-F Tmax 90°C; or higher). Please contact your local Service Force Center for further advice.

A device must be provided in the electrical installation which allows the appliance to be disconnected from the mains at all poles with a contact opening width of at least 3 mm

Suitable isolation devices include line protecting cut-outs, fuses (screw type fuses are to be removed from the holder), earth leakage trips and contactors.

Electrical Connection Diagram

For UK only: 230V...240V~

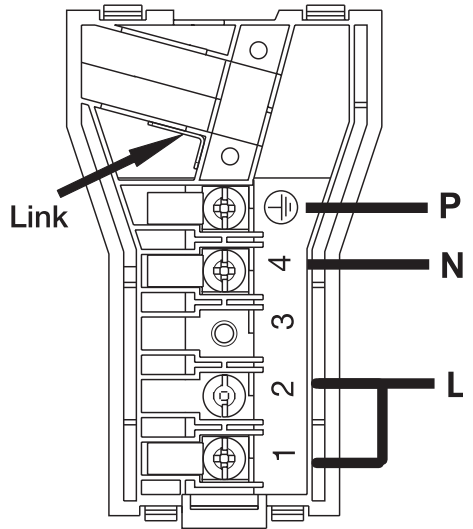

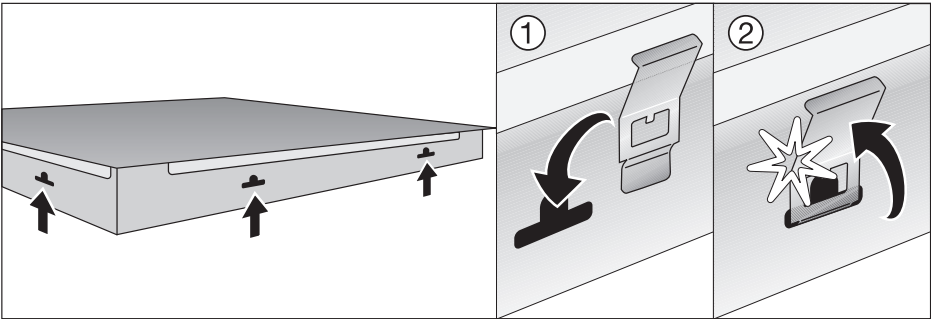
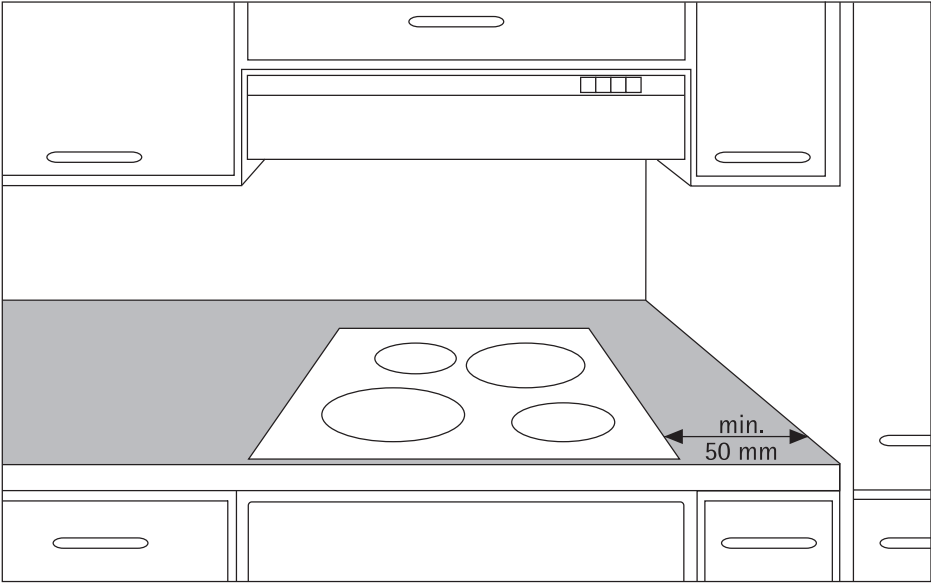

Assembly

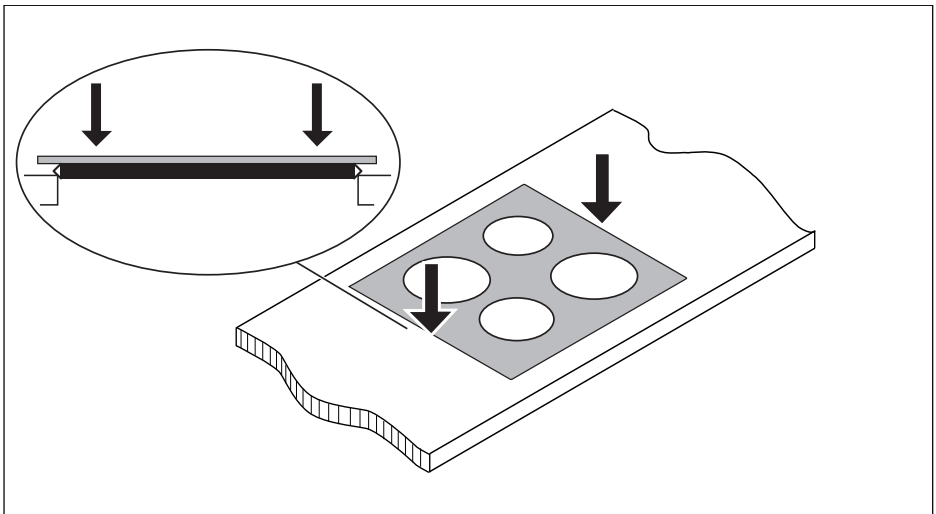
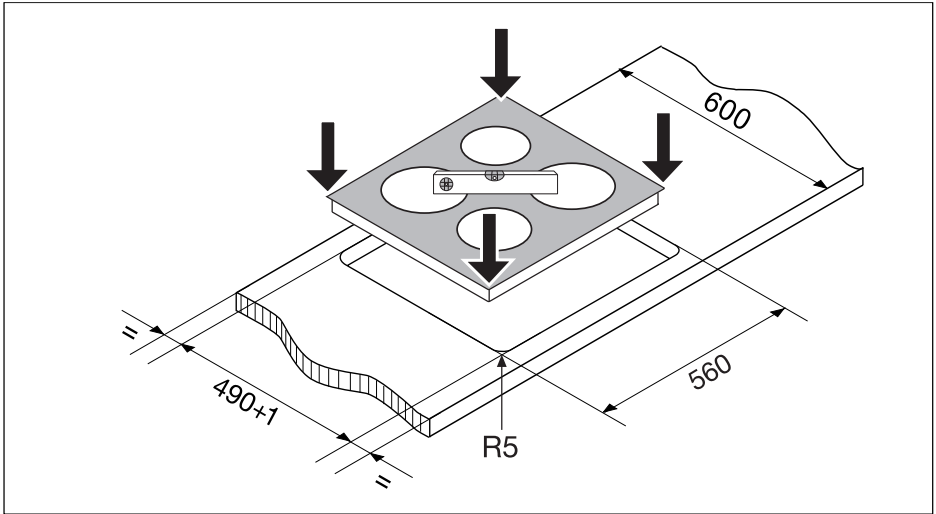

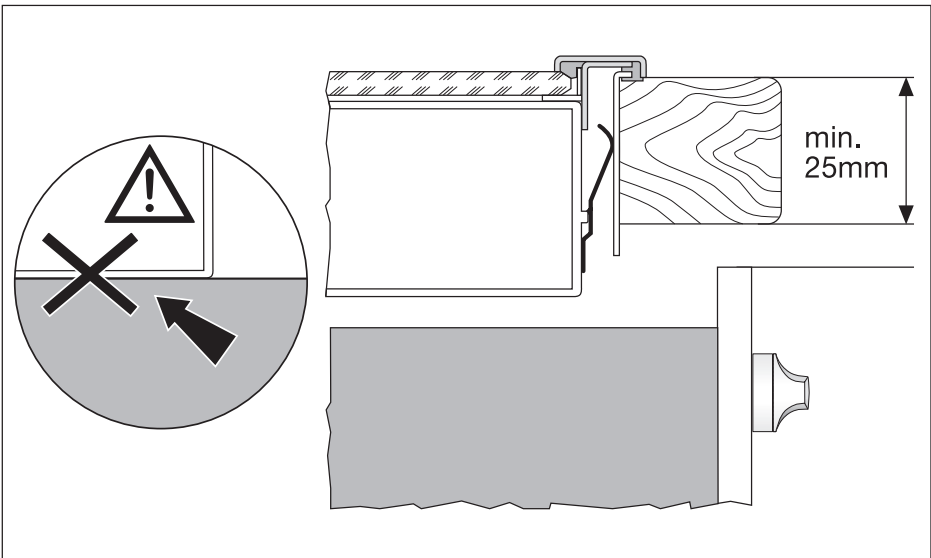
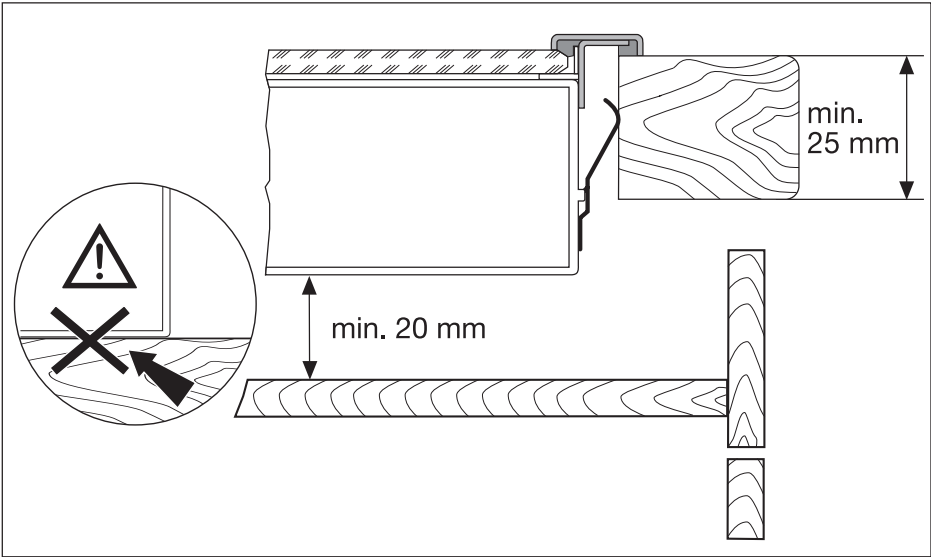



Rating Plate

Modell EHS60020K		Prod.Nr. 949 592 640	
Typ PEE2019	230 V	50 Hz	
Made in Germany	Ser.Nr.....	6,5 kW	
ELECTROLUX			

Guarantee/Customer Service

Standard guarantee conditions

We, Electrolux, undertake that if within 12 months of the date of the purchase this Electrolux appliance or any part thereof is proved to be defective by reason only of faulty workmanship or materials, we will, at our option repair or replace the same **FREE OF CHARGE** for labour, materials or carriage on condition that:

- The appliance has been correctly installed and used only on the electricity supply stated on the rating plate.
- The appliance has been used for normal domestic purposes only, and in accordance with the manufacturer's instructions.
- The appliance has not been serviced, maintained, repaired, taken apart or tampered with by any person not authorised by us.
- All service work under this guarantee must be undertaken by a Service Force Centre.
- Any appliance or defective part replaced shall become the Company's property.
- This guarantee is in addition to your statutory and other legal rights.

Home visits are made between 8.30am and 5.30pm Monday to Friday. Visits may be available outside these hours in which case a premium will be charged.

Exclusions

This guarantee does not cover:

- Damage or calls resulting from transportation, improper use or neglect, the replacement of any light bulbs or removable parts of glass or plastic.
- Costs incurred for calls to put right an appliance which is improperly installed or calls to appliances outside the United Kingdom.
- Appliances found to be in use within a commercial environment, plus those which are subject to rental agreements.
- Products of Electrolux manufacture which are not marketed by Electrolux.



European Guarantee

This appliance is guaranteed by Electrolux in each of the countries listed at the back of this user manual, for the period specified in the appliance guarantee or otherwise by law. If you move from one of these countries to another of the countries listed below the appliance guarantee will move with you subject to the following qualifications:

- The appliance guarantee starts from the date you first purchased the appliance which will be evidenced by production of a valid purchase document issued by the seller of the appliance.
- The appliance guarantee is for the same period and to the same extent for labour and parts as exists in your new country of residence for this particular model or range of appliances.
- The appliance guarantee is personal to the original purchaser of the appliance and cannot be transferred to another user.
- The appliance is installed and used in accordance with instructions issued by Electrolux and is only used within the home, i.e. is not used for commercial purposes.
- The appliance is installed in accordance with all relevant regulations in force within your new country of residence.

The provisions of this European Guarantee do not affect any of the rights granted to you by law.

www.electrolux.com

		
Albania	+35 5 4 261 450	Rr. Pjeter Bogdani Nr. 7 Tirane
Belgique/België/ Belgien	+32 2 363 04 44	Bergensesteenweg 719, 1502 Lembeek
Česká republika	+420 2 61 12 61 12	Budějovická 3, Praha 4, 140 21
Danmark	+45 70 11 74 00	Sjællandsgade 2, 7000 Fredericia
Deutschland	+49 180 32 26 622	Muggenhofer Str. 135, 90429 Nürnberg
Eesti	+37 2 66 50 030	Mustamäe tee 24, 10621 Tallinn
España	+34 902 11 63 88	Carretera M-300, Km. 29,900 Alcalá de Henares Madrid
France	www.electrolux.fr	
Great Britain	+44 8705 929 929	Addington Way, Luton, Bedfordshire LU4 9QQ

		
Hellas	+30 23 10 56 19 70	4 Limnou Str., 54627 Thessaloniki
Hrvatska	+385 1 63 23 338	Slavonska avenija 3, 10000 Zagreb
Ireland	+353 1 40 90 753	Long Mile Road Dublin 12
Italia	+39 (0) 434 558500	C.so Lino Zanussi, 26 - 33080 Porcia (PN)
Latvija	+37 17 84 59 34	Kr. Barona iela 130/2, LV-1012, Riga
Lietuva	+370 5 2780609	Verkių 29, LT-09108 Vilnius
Luxembourg	+35 2 42 43 13 01	Rue de Bitbourg, 7, L-1273 Hamm
Magyarország	+36 1 252 1773	H-1142 Budapest XIV, Erzsébet királyné útja 87
Nederland	+31 17 24 68 300	Vennootsweg 1, 2404 CG - Alphen aan den Rijn
Norge	+47 81 5 30 222	Risløkkvn. 2 , 0508 Oslo
Österreich	+43 18 66 400	Herziggasse 9, 1230 Wien
Polska	+48 22 43 47 300	ul. Kolejowa 5/7, Warsaw
Portugal	+35 12 14 40 39 39	Quinta da Fonte - Edifício Gonçalves Zarco - Q 35 2774 - 518 Paço de Arcos
Romania	+40 21 451 20 30	Str. Garii Progresului 2, S4, 040671 RO
Schweiz/Suisse/ Svizzera	+41 62 88 99 111	Industriestrasse 10, CH-5506 Mägenwil
Slovenija	+38 61 24 25 731	Electrolux Ljubljana, d.o.o. Tržaška 132, 1000 Ljubljana
Slovensko	+421 2 43 33 43 22	Electrolux Slovakia s.r.o., Electrolux Domáce spotrebiče SK, Seberínho 1, 821 03 Bratisla- va
Suomi	+35 8 26 22 33 00	Konepajanranta 4, 28100 Pori
Sverige	+46 (0)771 76 76 76	Electrolux Service, S:t Göransgatan 143, S-105 45 Stockholm
Türkiye	+90 21 22 93 10 25	Tarlabası caddesi no : 35 Taksim Istanbul
Россия	+7 495 9377837	129090 Москва, Олимпийский проспект, 16, БЦ „Олимпик“

Service and Spare Parts

If the event of your appliance requiring service, or if you wish to purchase spare parts, please contact Service Force by telephoning:

0870 5 929 929

Your telephone call will be automatically routed to the Service Force Centre covering your post code area.

For the address of your local Service Force Centre and further information about Service Force, please visit the website at

www.serviceforce.co.uk

Before calling out an engineer, please ensure you have read the details under the heading „What to do if...“

When you contact the Service Force Centre you will need to give the following details:

1. Your name, address and post code.
2. Your telephone number.
3. Clear and concise details of the fault.
4. The model and serial number of the appliance (found on the rating plate)
5. The purchase date.

Please note that a valid purchase receipt or guarantee documentation is required for in-guarantee service calls.

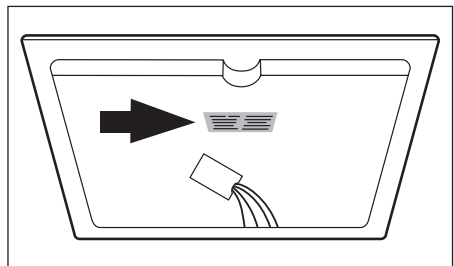

Customer Care

For general enquiries concerning your Electrolux appliance, or for further information on Electrolux products please contact our Customer Care Department by letter or telephone at the address below or visit our website at

www.electrolux.co.uk

Customer Care Department
Major Appliances
Electrolux
Addington Way
Luton
Bedfordshire, LU4 9QQ
Tel: 08705 350350 (*)

For Customer Service in the Republic of Ireland please contact us at the address below:
AEG/ Electrolux Group (Ire) Ltd
Long Mile Road/ Dublin 12
Republic of Ireland
Tel: +353 (0) 1 4090753
Email: service.eid@electrolux.ie

(*) Calls may be recorded for training purposes

www.electrolux.com

www.electrolux.co.uk