



user manual

Oven  
EDOM

**We were thinking of you**  
when we made this product



## IMPORTANT SAFETY INFORMATION

These warnings are provided in the interests of your safety. Ensure that you understand them all before installing or using the appliance. Your safety is of paramount importance. If you are unsure about any of the information in this book contact the Customer Care Department.

### INSTALLATION

The appliance **must** be installed according to the instructions supplied. The installation work must be undertaken by a qualified electrician or competent person.

The appliance should be serviced by an authorised Service Engineer and only genuine approved spare parts should be used.

The appliance **must** be installed in an adequately ventilated room.

It is imperative that the appliance is left in the base to protect both the appliance and the floor.

This appliance is heavy and care **must** be taken when moving it.

**Do not** attempt to lift or move this appliance by the handles.

All packaging, both inside and outside the appliance **must** be removed before the appliance is used.

It is dangerous to alter the specifications or modify the appliance in any way.

After installation please dispose of the packaging with due regard for safety and the environment. Your local authority can arrange this.

### CHILD SAFETY

**Do not** allow children to play with any part of the packaging.

**Do not** allow children to sit or climb on the drop down doors.

This appliance is designed to be operated by adults. Young children **must not** be allowed to tamper with the controls or play near or with the appliance.

**Warning: Accessible parts may be hot during use.**  
Young children should be kept away.

### DURING USE

This appliance is not intended to be operated by means of an external timer or separate remote control system.

This appliance has been designed for domestic use to cook edible foodstuffs only and **must not** be used for any other purposes.

Take great care when heating fats and oils as they will ignite if they become too **hot**.

Never place plastic or any other material which may melt in or on the oven.

**Do not** leave the grill pan handle in position when grilling as it will become **hot**.

Always support the grill pan when it is in the withdrawn or partially withdrawn position.

Always use oven gloves to remove and replace the grill pan handle when grilling.

Always use oven gloves to remove and place food in the oven.

During use the appliance becomes hot. Care should be taken to avoid touching heating elements inside the oven.

Ensure that all vents are not obstructed to ensure ventilation of the oven cavity.

Never line any part of the appliance with foil.

**Always** stand back from the appliance when opening the doors to allow any build up of steam or heat to release.

**Never leave the appliance unattended when the oven door is open.**

**Do not** place sealed cans or aerosols inside the oven. They may explode if they are heated.

Ensure that all control knobs are in the OFF position when not in use.

**Do not** stand on the appliance or on the open oven doors.

**Do not** hang towels, dishcloths or clothes from the appliance or its handles.

**Do not** use this appliance if it is in contact with water. **Never** operate it with wet hands.

### CLEANING AND MAINTENANCE

For hygiene and safety reasons this appliance should be kept clean at all times. A build-up of fats or other foodstuffs could result in a fire especially in the grill pan.

**Do not** leave the cookware containing foodstuffs, e.g. fat or oil in the appliance in case it is inadvertently switched on.

Always allow the appliance to cool before switching off at the wall prior to carrying out any cleaning / maintenance work.

Only clean this appliance in accordance with the instructions given in this book.

### AT THE END OF THE APPLIANCE'S LIFE



The symbol  on the product or on its packaging indicates that this product may not be treated as household waste. Instead it shall be handed over to the applicable collection point for the recycling of electrical and electronic equipment. By ensuring this product is disposed of correctly, you will help prevent potential negative consequences for the environment and human health, which could otherwise be caused by inappropriate waste handling of this product. For more detailed information about recycling of this product, please contact your local city office, your household waste disposal service or the shop where you purchased the product.

# CONTENTS

## FOR THE USER

<b>Important Safety Information</b>	3
<b>Description Of The Appliance</b>	5
Getting To Know Your Appliance	6
Grill And Oven Furniture	7
Before Using The Appliance	8
Rating Plate	8
Preparing To Use Your Appliance	8
When First Switching On	8
The Cooling Fan For The Controls	8
Control Panel Indicator Neon(s)	8
Condensation And Steam	8
Cookware	8
Helpful Hints When Buying And Preparing Food	8
<b>Electronic Timer</b>	9
<b>The Dual Grill</b>	12
Using The Dual Grill	12
Things To Note	12
The Grill Pan and Handle	12
Hints And Tips	13
Grilling Chart	13
<b>The Top Oven</b>	14
Using The Top Oven	14
Things To Note	14
To Fit The Top Oven Shelf	14
Hints And Tips	15
<b>Top Oven Cooking Chart</b>	16
<b>The Main Oven</b>	17
Using The Main Oven	17
Things To Note	17
To Fit The Main Oven Shelves	17
Hints And Tips	18
<b>Main Oven Cooking Chart</b>	19
<b>Roasting Chart</b>	20
<b>Defrost Feature</b>	21
Using Defrost Feature	21
Things To Note	21
Hints And Tips	21

<b>Care and Cleaning</b>	22
Cleaning Materials	22
Cleaning The Outside Of The Appliance	22
Removing and Replacing Wirework Runners	22
Cleaning Inside The Ovens	23
Cleaning The Door(s)	24
To Remove The Outer Glass Door	24
To Replace The Outer Glass Door	25
To Clean The Inner Glass Door	25
Cleaning The Grill And Oven Furniture	25
Replacing An Oven Light Bulb	26
<b>Something Not Working</b>	27
<b>Service and Spare Parts</b>	28
<b>Guarantee Conditions</b>	29

## FOR THE INSTALLER

<b>Technical Details</b>	30
<b>Installation Instructions</b>	31
Warnings	31
Things To Note	31
Choice Of Electrical Connection	32
Preparing Cabinet For Fitting Of Oven	32
Recommended Cabinet Dimensions	33
How To Finish Unpacking	34
To Remove Cover Of Mains Terminal	34
Connecting To The Mains Terminal	35
Checking Electrical Connections	35
Connecting To A Hob Or Cooker Point	35
Fitting Into The Cabinet	36

To help you the following symbols will be found in the text.



Hints and Tips



Safety Instructions

Please read the instruction book carefully before use and retain for future reference.

# DESCRIPTION OF THE APPLIANCE

## BUILT-IN ELECTRIC DOUBLE OVEN

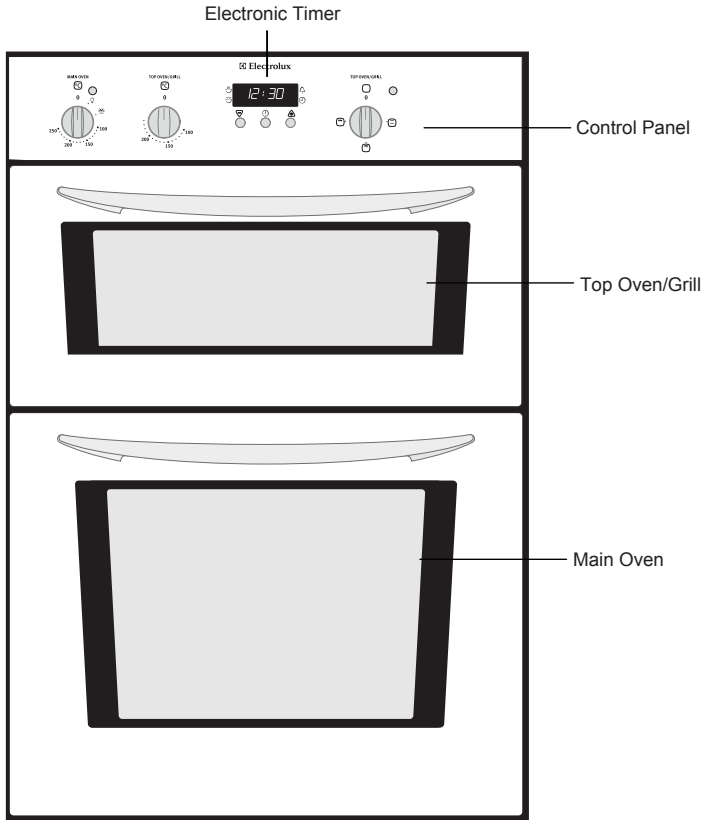

Your built-in appliance comprises of a conventional oven and dual grill in the top compartment. The main oven can be automatically controlled by the electronic timer.

# GETTING TO KNOW YOUR APPLIANCE

## THE CONTROL PANEL

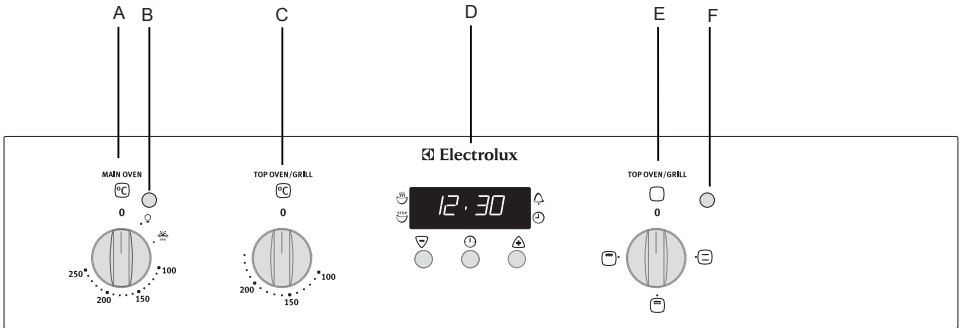

- A - Main Oven Temperature Control
- B - Main Oven Indicator Neon
- C - Top Oven /Grill Temperature Control
- D - Electronic Timer
- E - Top Oven/Grill Function Selector
- F - Top Oven/Grill Selector Indicator Neon

### Things to note

#### Main oven lamp

It is possible to turn the lamp on in your main oven to help visibility when cleaning

Turn the main oven temperature control to the lamp setting .

## GRILL AND OVEN FURNITURE

The following items of oven furniture have been supplied with the appliance:-

1 grill pan

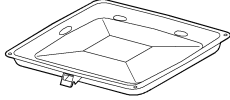

1 grill pan handle

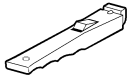

1 grill pan grid

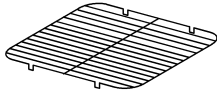

1 shelf for grilling and top oven cooking

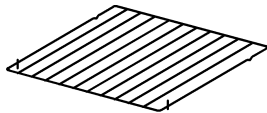

2 shelves for main oven cooking

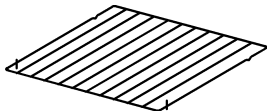

# BEFORE USING THE APPLIANCE

## RATING PLATE

This is situated on the lower front frame of the appliance and can be seen upon opening the door. Alternatively the rating plate may also be found on the back or top of some models (where applicable).

The appliance must be protected by a suitably rated fuse or circuit breaker. The rating of the appliance is given on the rating plate.

**Do not remove the rating plate from the appliance as this may invalidate the guarantee.**

## PREPARING TO USE YOUR APPLIANCE

Wipe over the base of the oven(s) with a soft cloth and hot soapy water and wash the furniture before use. We suggest that you run the oven elements for 10 – 15 minutes at 220°C to burn off any residue from their surfaces. The procedure should be repeated with the grill for approximately 5 – 10 minutes.

During this period an odour may be emitted, it is therefore advisable to open a window for ventilation.

## WHEN FIRST SWITCHING ON

The oven has a 24 hour clock. When the oven is first switched on at the wall the electronic display will automatically show 12.00 and the 'Time' ( ⊕ ) neon will also flash.

## THE COOLING FAN FOR THE CONTROLS

The cooling fan comes on immediately when the grill is switched on and after a short time when the oven is in use. It runs on after the controls are switched off until the appliance has cooled. During the initial period the cooling fan may turn ON and OFF, this is quite normal.



**Always allow the cooling fan to cool the appliance down before switching off at the wall prior to carrying out any cleaning or maintenance work.**

## CONTROL PANEL INDICATOR NEON(S)

The indicator neon will operate when the grill (where applicable) or oven(s) is switched on. The indicator neon will glow. It may turn on and off during use to show that the setting is being maintained. If the neon does not operate as the instructions indicate the controls have been incorrectly set. Return all controls to zero and reset following the instructions for the required setting.

## CONDENSATION AND STEAM

When food is heated it produces steam similar to a boiling kettle. The vents allow some of this steam to escape. However, always stand back from the appliance when opening the door(s) to allow any build up of steam or heat to release.

If the steam comes into contact with a cool surface on the outside of the appliance, e.g. a trim, it will condense and produce water droplets. This is quite normal and is not caused by a fault on the appliance.

To prevent discolouration, regularly wipe away condensation and also soilage from surfaces.

## COOKWARE

Baking trays, dishes etc., should not be placed directly against the grid covering the fan at the back of the oven.

**Do not** use baking trays larger than 30cm x 35cm (12" x 14") as they will restrict the circulation of heat and may affect performance.

## HELPFUL HINTS WHEN BUYING AND PREPARING FOOD

Care must be taken when handling foods in the home. Always follow the basic rules of food hygiene to prevent bacterial and microbial growth and cross contamination when preparing, reheating, cooking, cooling, defrosting and freezing foods:-

1. Avoid buying chilled or frozen products if you cannot store them straight away. The use of an insulated container when shopping is advisable.
2. When you arrive home, place perishable foods in the refrigerator or freezer immediately. Ensure they are well covered to prevent them drying out and to prevent any possible cross contamination with bacteria from raw to cooked foods.
3. In the kitchen keep work tops, chopping boards and utensils clean with hot soapy water between preparation stages. Ideally, keep one chopping board for raw meat and another for other foods. Keep your dish cloths and tea towels clean.

## Energy save mode

Your timer has an energy save mode which allows you to switch the display off.

By switching off the time display you can save energy.

### Switching off the time display

Press and hold any two buttons until the display switches off.

### Switching on the time display

Press any button to switch on the display.



The display can only be switched off if none of The timer functions, 'Cooktime', 'Endtime', or 'Countdown', is in use.



# ELECTRONIC TIMER

## KEY

- A COOK TIME
- B END TIME
- C COUNTDOWN
- D TIME
- E DECREASE CONTROL
- F SELECTOR CONTROL
- G INCREASE CONTROL

## NOTE:

The time of day must be set before the main oven will operate manually.

### 1. HOW TO SET THE TIME OF DAY

The oven has a 24 hour clock.

When the electricity supply is first switched ON, the display will show 12.00 and the 'Time' (⌚) indicator neon will flash as Fig. 1.

To set the correct time press the increase control button (+) and if necessary, the decrease control button (-) until the correct time on the 24 hour clock is reached, e.g. 10.00am as Fig.2. The 'Time' indicator neon (⌚) will flash for 5 seconds and then go out.

**Note:** The increase and decrease control buttons operate slowly at first, and then more rapidly. They should be pressed separately.

### 2. HOW TO SET THE COUNTDOWN

The 'Countdown' gives an audible reminder at the end of any period of cooking. This cooking period may be up to 2 hrs 30 mins. It is not part of the automatic control.

To set, press the Selector Control button (⊕) until the 'Countdown' indicator neon (⚠) is illuminated the display reads 0.00 as Fig.3.

To set the correct time duration depress the increase control (+) until the display indicates the interval to be timed, e.g. 1hr 45 mins as Fig. 4. If necessary depress the decrease control (-) to achieve the correct time interval.

**NOTE:** This must be completed within 5 seconds of first pressing the Selector Control button.

During the operation of the 'Countdown', the remaining time period will be shown in the display. The 'Countdown' will sound intermittently for up to 2 minutes at the end of the timed period. The sound can be stopped by pressing any button.

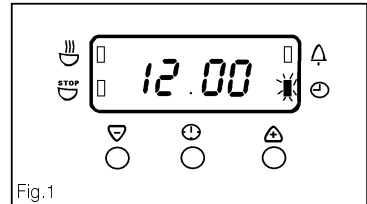
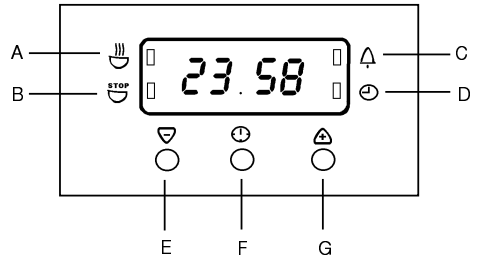

Fig.1

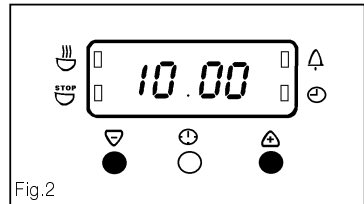

Fig.2

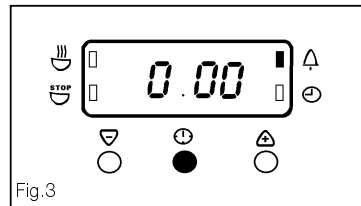

Fig.3

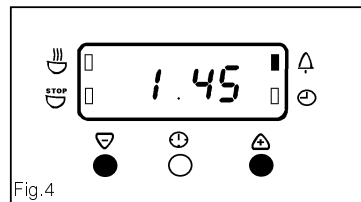

Fig.4

## TO CANCEL THE COUNTDOWN

If you change your mind and want to cancel the 'Countdown', press the Selector Control button until the 'Countdown' indicator neon ( $\Delta$ ) flashes and then the decrease control ( - ) until 0.00 shows in the display as Fig. 5. The 'Countdown' indicator neon ( $\Delta$ ) will continue to flash for a few seconds and then return to the time of day.

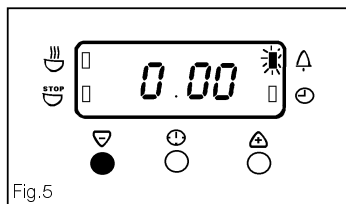

Fig.5

## 3. SETTING THE OVEN TIMER CONTROL

The main oven only can be automatically timed. When using the timer control for the very first time, it is advisable to let it operate while you are at home. The displays can be checked to show that it is operating correctly and you will feel confident to leave a meal to cook automatically in the future.

### A) TO SET THE TIMER TO SWITCH ON AND OFF AUTOMATICALLY

- i) Ensure the electricity supply is switched ON and that the correct time of day is displayed, e.g. 9.am. as Fig. 6.
- ii) Place food in the oven.
- iii) To set the length of cooking time, press the Selector control button ( $\Delta$ ) until the 'Cook Time' indicator neon is illuminated ( $\text{☺}$ ). Press the increase control ( + ) until the required length of cooking time is displayed, e.g. 2 hrs 15 mins as Fig. 7. If necessary depress the decrease control ( - ) until the correct time interval is achieved.  
The maximum cooking time is 10 hours.
- iv) Release the buttons. The 'Cook Time' indicator neon ( $\text{☺}$ ) will be illuminated.

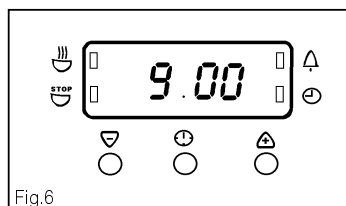

Fig.6

**Remember, this must be completed within 5 seconds of first pressing the Selector Control button.**

- v) To set the 'End Time'. Press the Selector Control button until the 'End Time' indicator neon ( $\text{☹}$ ) flashes. Press the increase control ( + ) until the required stop time is displayed, e.g. 12.15 p.m. as Fig. 8. If necessary press the decrease control ( - ) until the correct time interval is achieved.
- vi) Release the buttons. The time of day will be displayed after 5 seconds. The 'Cook Time' ( $\text{☺}$ ) and 'End Time' ( $\text{☹}$ ) indicator neons will be illuminated.

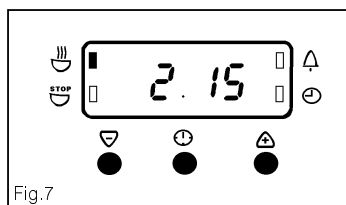

Fig.7

The 'End Time' must not be more than 23 hours 59 minutes from the time of day. For example, if the time of day is 09.00 a.m., the latest 'End Time' would be 08.59 a.m. the next day.

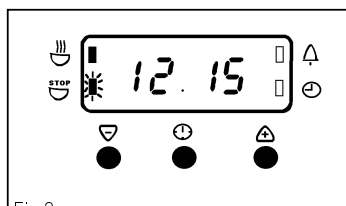

Fig.8

- vii) Set the main oven control to the required temperature. The oven indicator neon should be OFF.

**NOTE: When the automatic timed period starts, the oven indicator neon will glow. It may turn on and off during use to show that the setting is being maintained.**

## B) TO SET THE TIMER TO SWITCH OFF ONLY

- i) Ensure the electricity supply is switched ON and that the correct time of day is displayed, e.g. 10.00am as Fig. 9.
- ii) Place food in the oven.
- iii) To set the length of cooking time, press the Selector Control button until the 'Cook Time' (👉) indicator neon is illuminated. Press the increase control ( + ) until the required length of cooking time is displayed, e.g. 2 hrs 15 mins as Fig. 10. Depress the decrease control ( - ) if necessary.
- iv) Release the buttons. The 'Cook Time' indicator neon (👉) will illuminate and the time of day will be displayed after 5 seconds.
- v) Set the oven temperature. The oven indicator neon should be ON.
- vi) To check the 'End Time' during the cooking period, simply press the Selector Control button once and the remaining time will be displayed, as Fig. 11.

## 4. TO CANCEL AN AUTOMATIC PROGRAMME

- i) To cancel an automatic programme press the Selector Control button until the 'Cook Time' indicator neon (👉) flashes. Press the decrease control ( - ) until the display reads 0.00 as Fig. 12.
- ii) Release the buttons. The 'Cook Time' indicator neon (👉) will flash and after 5 seconds return to the time of day.
- iii) Turn off the oven controls.

## 5. TO RETURN THE APPLIANCE TO MANUAL

At the end of a timed cooking period, the indicator neon will flash and an alarm will sound for up to 2 minutes.

- i) To stop the sound press any of the three buttons, as Fig. 13.
- ii) The display will return to the time of day.
- iii) Turn off the oven controls.

## 6. THINGS TO NOTE

In the event of an interruption of the electricity supply, the timer will reset itself to zero, and all programming will be cancelled.

## 7. AUTOMATIC COOKING

It is advisable to leave food in the oven for as short a time as possible before automatic cooking. Always ensure commercially prepared food is well within its use by date and that home prepared food is fresh and of good quality.

When cooking is complete, **do not** leave food to stand in the oven, but remove and cool it quickly if the food is not to be consumed immediately.

Always ensure food in the oven has been covered before cooking if it is not possible to remove food immediately after cooking.

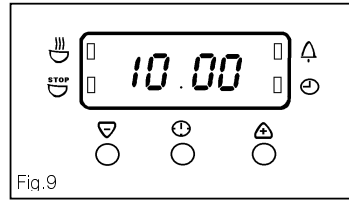

Fig.9

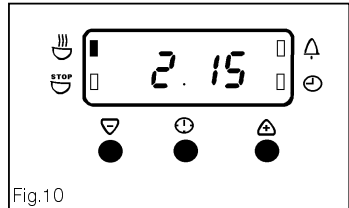

Fig.10

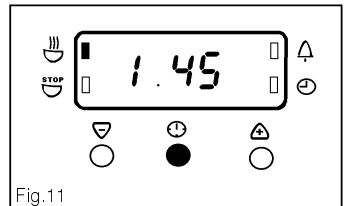

Fig.11

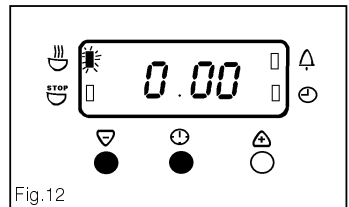

Fig.12

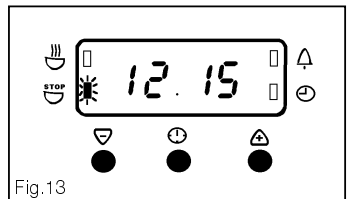





Fig.13

# THE DUAL GRILL

 **WARNING – Accessible parts may become hot when the grill is in use. Keep children away.**

The grill is a dual circuit grill which means that the full area of the grill can be used, or for economy purposes, the centre section only can be used when cooking smaller quantities of food.

## USING THE DUAL GRILL

- To operate the grill turn the top oven/grill function selector to full grill. 
- Turn the top oven/grill function selector to centre section only. 
- Turn the top oven/grill temperature control knob to the right as far as it will go. This is the hottest setting.
- To use the grill at lower settings, turn the temperature control knob to 100°C or 150°C.

 **The grill door must be left open when grilling.**

## THINGS TO NOTE

- The oven light will illuminate.
- The cooling fan for the controls may operate after a time.
- The dual grill operates independently of the oven.

 **Ensure the grill pan is properly located.**

## THE GRILL PAN AND HANDLE

The grill pan has a removable handle.

To insert the handle, press the button on the handle with the thumb and pivot slightly upwards inserting the lip into the widest part of the bracket. Move the handle towards the left, lower into position and release the button.

 **Ensure the handle is properly located.**

To remove the handle, press the button on the handle with the thumb and pivot the handle slightly upwards and towards the right to remove from the bracket.

 **Protect your hands when removing the grill pan handle. Always remove the grill pan handle during grilling.**

To check the progress of the food being grilled, the grill pan should be withdrawn on the shelf to attend to food during cooking.

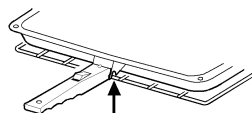
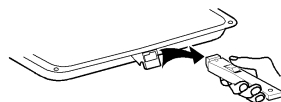
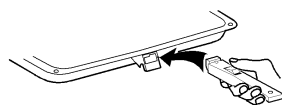
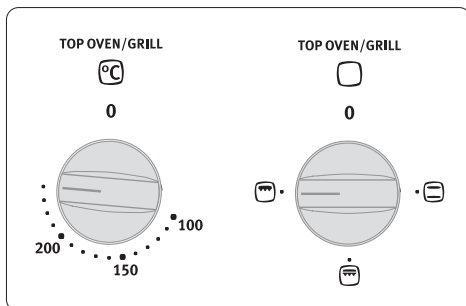

## **i** HINTS AND TIPS

- Most foods should be placed on the grid in the grill pan to allow maximum circulation of air to lift the food out of the fats and juices.
- Adjust the grid and grill pan runner position to allow for different thicknesses of food. Position the food close to the element for faster cooking and further away for more gentle cooking.
- Food should be thoroughly dried before grilling to minimise splashing. Brush lean meats and fish lightly with a little oil or melted butter to keep them moist during cooking.
- Accompaniments such as tomatoes and mushrooms may be placed around the outer edges or underneath the grid when grilling meats.
- When toasting bread, we suggest that the top runner position is used with the grid in its 'high' position.
- When using the centre section grill, ensure food is placed centrally on the grilling grid directly beneath the grill element.
- Preheat the grill on full setting for a few minutes to seal meat or for toasting. Adjust the heat setting and the shelf position as necessary during cooking.
- The food should be turned over during cooking as required

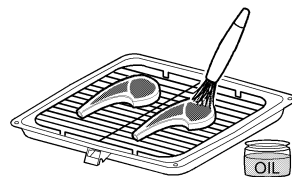

## GRILLING CHART

FOOD	POSITION	GRILL TIME (mins in total)
Bacon Rashers	Adjust	5 - 6
Beefburgers	grill	10 - 15
Chicken Joints	setting	30 - 40
Chops – Lamb	and	15 - 20
Pork		20 - 30
Fish – Whole Trout/Mackerel	grill	15 - 25
Fillets - Plaice/Cod	pan	10 - 15
Kebabs	grid	20 - 30
Kidneys – Lamb/Pig	to	8 - 12
Liver – Lamb/Pig	suit	10 - 20
Sausages	different	20 - 30
Steaks – Rare	thicknesses	6 - 12
Medium		12 - 16
Well Done	of	14 - 20
Toasted Sandwiches	food	3 - 4

The times quoted above are given as a guide and should be adjusted to suit personal taste.

# THE TOP OVEN

The top oven is the smaller of the two ovens. It is heated by elements in the top and bottom of the oven. It is designed for cooking smaller quantities of food. It gives especially good results if used to cook fruit cakes, sweet or savoury flans or quiche.

The top oven is also ideal for use as a warming compartment to warm dishes and keep food hot. Use the top oven when you want to warm plates. Use the lowest setting on the top oven temperature control.

## USING THE TOP OVEN

- Turn the top oven/grill function selector to .
- Turn the top oven/grill temperature control to the required setting.

## THINGS TO NOTE

- The oven light will illuminate.
- The indicator neon will glow. It may turn ON and OFF during use to show that the setting is being maintained.
- The cooling fan for the controls may operate after a time.

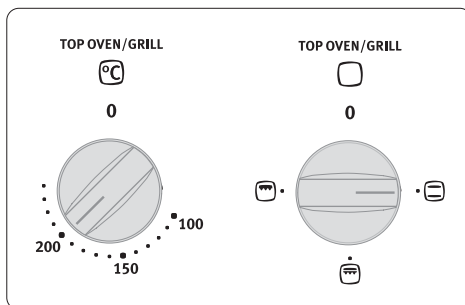

Do not place dishes, tins and trays directly on the oven base as it becomes very hot and damage will occur.

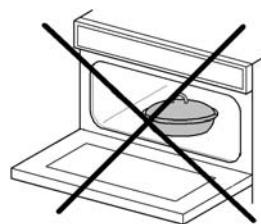

## TO FIT THE TOP OVEN SHELF

The shelf should be fitted with the straight rods uppermost on the frame and the forms towards the back of the oven.

To remove a shelf slide the shelf towards you until the shelf stop is reached. Tilt shelf up at the front so that the stops clear the side supports. Lift shelf clear. To install a shelf, reverse the above steps. Each shelf position has an upper and lower support wire, ensure the shelf is placed between these two support wires.

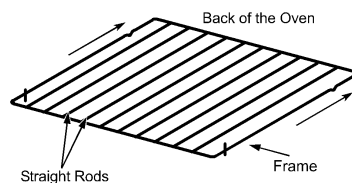

## HINTS AND TIPS

- Arrange the shelf in the required position before switching the oven ON. Shelf positions are counted from the bottom upwards.
- There should always be at least 2.5cm (1") between the top of the food and the element. This gives best cooking results and allows room for rise in yeast mixtures, Yorkshire puddings etc. When cooking cakes, pastry, scones bread etc., place the tins or baking trays centrally on the shelf.
- Ensure that food is placed centrally on the shelf and there is sufficient room around the baking tray/dish to allow for maximum circulation.
- Stand dishes on a suitably sized baking tray on the shelf to prevent spillage onto the oven base and to help reduce cleaning.
- The material and finish of the baking tray and dishes used will affect the degree of base browning. Enamelware, dark, heavy or non-stick utensils increase base browning. Shiny aluminium or polished steel trays reflect the heat away and give less base browning.
- **Do not** place baking trays directly on the oven base as it interferes with the oven air circulation and can lead to base burning; use the lower shelf position.
- Because of the smaller cooking space and lower temperatures, shorter cooking times are sometimes required.
- For economy leave the door open for the shortest possible time, particularly when placing food into a pre-heated oven.

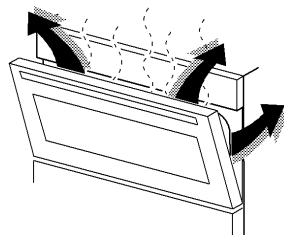
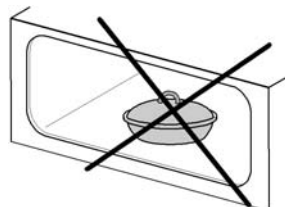
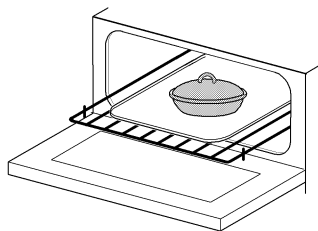
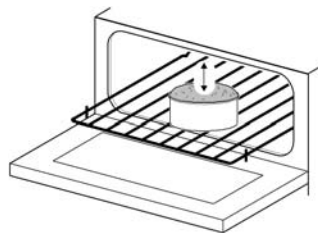

Do not place cookware and cooking pots with rough bases e.g. cast iron on the oven door as damage to the glass may occur.

---

# TOP OVEN COOKING CHART

The oven temperatures are intended as a guide only. It may be necessary to increase or decrease the temperatures by 10°C to suit individual preferences and requirements.

		TOP OVEN		
FOOD		SHELF POSITION	COOKING TEMP °C	APPROX COOK TIME (m)
Biscuits		1	170 - 190	10 - 20
Bread		1*	200 - 220	25 - 30
Bread rolls/buns		1	200 - 220	15 - 20
Cakes: Small & Queen		1	180 - 190	18 - 25
Sponges		1	160 - 170	18 - 20
Victoria Sandwich		1	160 - 170	18 - 25
Madeira		1	140 - 150	1¼ - 1½h
Rich Fruit		1	140 - 150	2¼ - 2½h
Christmas		1	130 - 140	3 - 4½h
				depends on size
Gingerbread		1	140 - 150	1¼ - 1½h
Meringues		1	90 - 100	2½ - 3h
Flapjack		1	170 - 180	25 - 30
Shortbread		1	140 - 150	45 - 65
Casseroles: Beef/Lamb		1*	140 - 160	2½ - 3h
Chicken		1*	180 - 190	1¼ - 1½h
Convenience Foods			Follow manufacturer's instructions	
Fish		1	170 - 190	20 - 30
Fish Pie (Potato Topped)		1*	190 - 200	20 - 25
Fruit Pies, Crumbles		1	190 - 200	40 - 50
Milk Puddings		1	140 - 150	1½ - 2h
Pasta Lasagne etc.		1	170 - 180	40 - 45
Pastry: Choux		1	180 - 190	30 - 35
Eclairs, Profiteroles		1	170 - 180	20 - 30
Flaky/Puff Pies		1*	210 - 220	25 - 40
Shortcrust Mince Pies		1	190 - 200	15 - 20
Meat Pies		1*	190 - 210	25 - 35
Quiche, Tarts, Flans		1	180 - 200	25 - 45
Roasting Meat, Poultry		1*	160 - 180	see roasting chart
Scones		1	220 - 230	8 - 12
Shepherd's Pie		1*	190 - 200	30 - 40
Soufflés		1	170 - 180	20 - 30
Vegetables: Baked Jacket Potatoes		1	180 - 190	1 - 1½h
Roast Potatoes		1	180 - 190	1 - 1½h
Yorkshire Puddings: Large		1	200 - 210	25 - 40
Individual		1	200 - 210	15 - 25

\* = Shelf on the oven base

**Note:** Shelf positions are counted from the bottom of the oven upwards.



# THE MAIN OVEN

The fan oven is particularly suitable for cooking larger quantities of food.

The advantages of fan oven cooking are:

## PREHEATING

The fan oven quickly reaches its temperature, so it is not usually necessary to preheat the oven. Without preheating however, you may find you need to add an extra 5 – 10 minutes on the recommended cooking times. For recipes needing high temperatures, e.g. bread, pastries, scones, soufflés etc., best results are achieved if the oven is preheated first. For best results when cooking frozen or cooked chilled ready meals always preheat the oven first.

## COOKING TEMPERATURES

Fan oven cooking generally requires lower temperatures than conventional cooking. Follow the temperatures recommended in the cooking chart. As a guide reduce temperatures by about 20°C - 25°C for your own recipes, using a conventional oven.

## BATCH BAKING

The fan oven cooks evenly on all shelf levels, especially useful when batch baking.

## USING THE MAIN OVEN

- Turn the main oven temperature control to the required setting.

## THINGS TO NOTE

- The oven light will illuminate.
- The indicator neon will glow. It may turn ON and OFF during use to show that the setting is being maintained.
- The cooling fan for the controls may operate after a time.
- The oven fan will operate.
- If an automatic programme has been set, the oven fan and light do not come on until cooking begins.

## TO FIT THE MAIN OVEN SHELVES

The shelves should be fitted with the straight rods uppermost on the frame and the forms towards the back of the oven.

To remove a shelf slide the shelf towards you until the shelf stop is reached. Tilt shelf up at the front so that the stops clear the side supports. Lift shelf clear. To install a shelf, reverse the above steps. Each shelf position has an upper and lower support wire, ensure the shelf is placed between these two support wires.

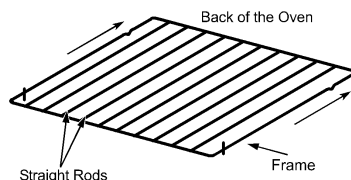
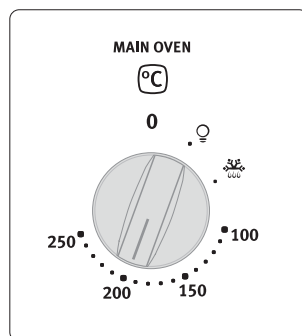

## **i**nsights and tips

- Arrange the shelves in the required positions before switching the oven on. Shelf positions are counted from the bottom upwards.
- When cooking more than one dish in the fan oven, place dishes centrally on different shelves rather than cluster several dishes on one shelf, this will allow the heat to circulate freely for the best cooking results.
- When batch baking one type of food, e.g. Victoria sandwich cakes, those of similar size will be cooked in the same time.
- It is recommended that when baking larger quantities the shelf positions should be evenly spaced to suit the load being cooked. A slight increase in cooking time may be necessary.
- Do not place baking trays directly on the oven base as it interferes with the oven air circulation and can lead to base burning; use the lower shelf position.

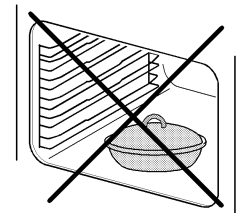
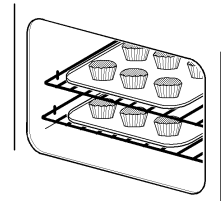
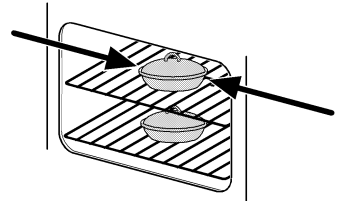
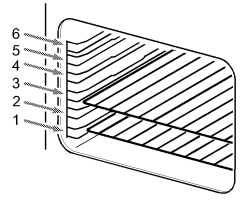

Do not place cookware and cooking pots with rough bases e.g. cast iron on the oven door as damage to the glass may occur.

# MAIN OVEN COOKING CHART

The oven temperatures are intended as a guide only. It may be necessary to increase or decrease the temperatures by a further 10°C to suit individual preferences and requirements.

FOOD	SHELF POSITION	COOKING TEMP °C
Biscuits	Shelf positions are not critical	180 - 190
Bread		200 - 220
Bread rolls/buns		200 - 220
Cakes: Small & Queen		160 - 170
Sponges		160 - 170
Victoria Sandwich		160 - 170
Madeira		140 - 150
Rich Fruit		130 - 140
Christmas		130 - 140
Gingerbread		140 - 150
Flapjack	critical	170 - 180
Shortbread		130 - 140
Casseroles: Beef/Lamb		140 - 160
Chicken	but ensure	180 - 190
Convenience Foods		Follow manufacturer's instructions
Fish		170 - 190
Fish Pie (Potato Topped)	that oven	190 - 200
Fruit Pies, Crumbles		190 - 200
Milk Puddings		130 - 140
Pasta Lasagne etc.	shelves	190 - 200
Pastry: Choux		190 - 200
Eclairs, Profiteroles	are	170 - 180
Flaky/Puff Pies		210 - 220
Shortcrust: Mince Pies		190 - 200
Meat Pies	evenly	190 - 210
Quiche, Tarts, Flans		180 - 210
Roasting Meat, Poultry	spaced	160 - 180
Scones		210 - 220
Shepherd's Pie		190 - 200
Soufflés	when more	170 - 180
Vegetables: Baked Jacket Potatoes		180 - 190
Roast Potatoes		180 - 190
	than one is	
Yorkshire Puddings: Large		210 - 220
Individual		200 - 210
	used	

# ROASTING CHART

INTERNAL TEMPERATURES – Rare : 50-60°C; Medium : 60-70°C; Well done : 70-80°C		
MEAT	TEMPERATURE	COOKING TIME
Beef/ Beef boned	160-180°C	20-35 minutes per ½kg (1lb) and 20-35 minutes over
Mutton/Lamb	160-180°C	25-35 minutes per ½kg (1lb) and 25-35 minutes over
Pork/Veal/Ham	160-180°C	30-40 minutes per ½kg (1lb) and 30-40 minutes over
Chicken	160-180°C	15-20 minutes per ½kg (1lb) and 20 minutes over
Turkey/Goose	160-180°C	15-20 minutes per ½kg (1lb) up to 3½kg (7lb) then 10 minutes per ½kg (1lb) over 3½kg (7lb)
Duck	160-180°C	25-35 minutes per ½kg (1lb) and 25-30 minutes over
Pheasant	160-180°C	35-40 minutes per ½kg (1lb) and 35-40 minutes over
Rabbit	160-180°C	20 minutes per ½kg (1lb) and 20 minutes over

The roasting temperatures and times given in the chart should be adequate for most joints, but slight adjustments may be required to allow for personal requirements and the shape and texture of the meat. However, lower temperatures and longer cooking times are recommended for less tender cuts or larger joints.

Wrap joints in foil if preferred, for extra browning uncover for the last 20 – 30 min. cooking time.

# DEFROST FEATURE

This fan oven function defrosts most foods faster than more conventional methods. It is particularly suitable for delicate frozen foods which are to be served cold e.g. cream filled gateaux, cakes covered with icings or frostings, cheesecakes, biscuits, scones, etc.

## USING DEFROST FEATURE

- Turn the main oven temperature control to the defrost setting. 

## THINGS TO NOTE

- The oven fan and internal oven light will come on.
- The cooling fan does not operate.

## HINTS AND TIPS

- Place the frozen food in a single layer where possible and turn it over half way through the defrosting process.
- The actual speed of defrosting is influenced by room temperature. On warm days defrosting will be faster than on cooler days.
- It is preferable to thaw fish, meat and poultry slowly in the fridge. However, this process can be accelerated by using the defrost function. Small or thin fish fillets, frozen peeled prawns, cubed or minced meat, liver, thin chops, steaks etc., can be thawed in 1 – 2 hours.
- A 1kg/2¼lb oven ready chicken will be thawed in approximately 5 hours. Remove the giblets as soon as possible during the thawing process.
- Joints of meat up to 2kg/4½lb in weight can be thawed using the defrost function.
- All joints of meat and poultry must be thawed thoroughly before cooking.
- Always cook thoroughly immediately after thawing.
- **Do not** leave food at room temperature once it is defrosted. Cook raw food immediately or store cooked food in the fridge, once it has cooled.
- Care must always be taken when handling foods in the home. Always follow the basic rules of food hygiene to prevent bacterial growth and cross contamination when defrosting, preparing, cooking, cooling and freezing foods.

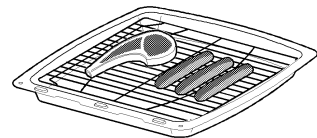
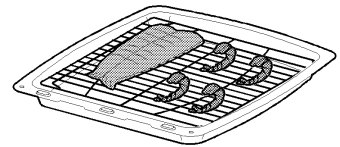
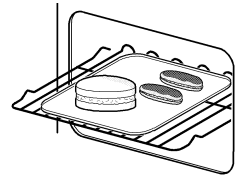
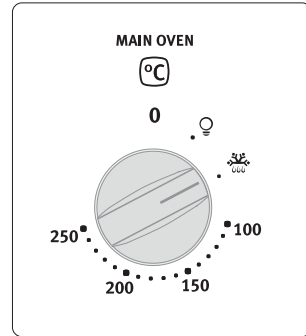

# CARE AND CLEANING

---

 Before cleaning always allow the cooling fan to cool the appliance down before switching off at the electricity supply.

---

## CLEANING MATERIALS

Before using any cleaning materials on your appliance, check that they are suitable and that their use is recommended by the manufacturer. Cleaners that contain bleach should NOT be used as they may dull the surface finishes. Harsh abrasives and scourers should also be avoided as damage will occur.

## CLEANING THE OUTSIDE OF THE APPLIANCE

Do not use abrasive cleaning materials e.g. Hob Brite, Brillo pads or scourers on painted or printed finishes as damage may occur. Regularly wipe over the control panel, doors and handles using a soft cloth and hot soapy water. To prevent streaking finish with a soft cloth. Stainless Steel cream cleaners are abrasive and should be avoided as they may dull the surface finish. **Any spillage on the stainless steel finish must be wiped off immediately.**

---

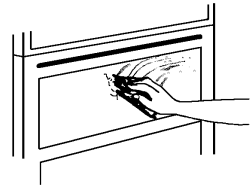
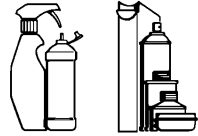

 Do not attempt to remove any of the control knobs from the appliance as this may cause damage and is a safety hazard.

---

 Under no circumstances should the door assembly be detached from the product for cleaning.

---

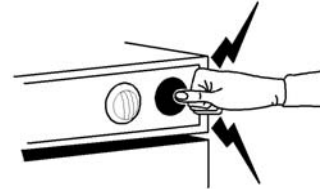

## REMOVING AND REPLACING WIREWORK RUNNERS

Remove all shelves and furniture from the oven.

Hold the wirework at the bottom, unclip from the cavity side and gently pull towards the centre of the oven.

Unhook the runner at the top and remove from the cavity.

To replace the runners, hook the wirework side runner into the cavity, slide back and press into place.

---

 Ensure the wirework runners are firmly in position before replacing the oven shelves.

---

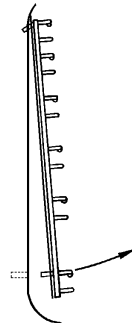

## CLEANING INSIDE THE OVENS

The sides and back of the grill/top oven and main oven compartments are coated with a special Stayclean coating. They should not be cleaned manually.

The vitreous enamel main oven base and grill compartment base can be cleaned using normal oven cleaners with care. Ensure that the manufacturers instructions are followed and that all parts are well rinsed afterwards.



Aerosol cleaners must not come into contact with elements or the door seal as this may cause damage.

---



### HINTS AND TIPS

---



Aerosol cleaners must not be used on Stayclean surfaces.

---

Stayclean surfaces destroy splashes of food and fats when the oven temperature is raised to around 220°C.

It is a good idea to run the oven for an hour or two per week to ensure continued good performance from the Stayclean finish.

Slight discolouration and polishing of the Stayclean surfaces may occur in time. This **DOES NOT** affect the Stayclean properties in any way.

Use minimal, if any, extra oil or fat when roasting meat, potatoes only require brushing with fat before cooking. Extra fat in the oven during roasting will increase splashing and soilage.

It is **NOT** necessary to add water to a meat tin when roasting. The water and the fat juices from the joint create excessive splattering during cooking – even at normal temperatures, as well as causing condensation.

Covering joints during cooking will also prevent splashing onto the interior surfaces. Removing the covering for the last 20-30 minutes will allow extra browning if required. Some large joints and turkeys especially benefit by this method of cooking, allowing the joint to cook through before the outside is over-browned.

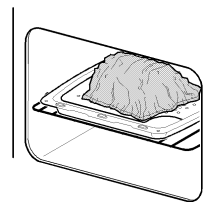
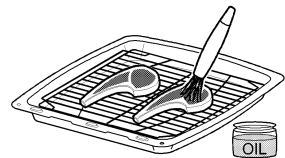

## CLEANING THE DOOR(S)

---



To prevent damaging or weakening the door glass panels avoid the use of the following:

- Household detergents and bleaches
  - Impregnated pads unsuitable for non-stick saucepans
  - Brillo/Ajax pads or steel wool pads
  - Chemical oven pads or aerosols
  - Rust removers
  - Bath/Sink stain removers
- 

The outer oven door glass panels are removable for cleaning.

### TO REMOVE THE OUTER DOOR GLASS

1. Open the oven door slightly to gain access to the two cross head screws on the top of the oven door.
2. Loosen the two screws using a Pozidrive screwdriver.
3. Holding the door glass securely in place with one hand remove the screws and washers with the other hand.

The screws and washers retain the trim on the top of the grill door. Note the position of the trim on the door.

4. Holding the door and glass with one hand, gently pull towards you and slightly lift the door glass with the other hand to disengage the panel from the location point at the bottom of the door. Gently release the door to close it.
5. Clean the outer and inner glass using hot soapy water or Hob Brite. Should the inner face of the outer door glass be heavily soiled it is recommended that soapy water with a high concentration of soap is used. To prevent streaking a glass cleaning spray may be applied and the glass polished with a soft cloth. Ensure that all parts are thoroughly dry before attempting to replace the outer door glass.

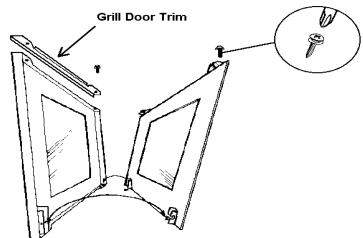

If the door glass panel becomes chipped or has deep scratches the glass will be weakened and must be replaced to prevent the possibility of the panel shattering. Please contact your local Service Force Centre who will be pleased to advise further.

---



## TO REPLACE THE OUTER DOOR GLASS

1. Holding the oven glass with both hands, gently place the locators into the holes of the brackets at the bottom of the oven door.

2. Holding the door glass with your left hand, use your right hand to open the oven door.

Bring the door gently towards the glass panel ensuring the screw location holes line up.

3. Place the trim in the correct position on the top of the grill door.

4. Hold the glass in place with one hand and insert the cross head screws with washers into the location holes with the other hand. Give the screws one turn to ensure the glass is secure.

5. Tighten the screws positively with a Pozidrive screwdriver before closing the oven door.

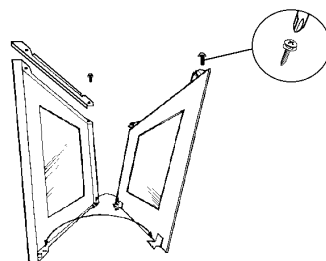

**Do not attempt to use the oven without the glass being in place.**

## TO CLEAN THE INNER GLASS DOOR

The inner glass door is not removable. Clean using hot soapy water or Hob Brite and a soft cloth. **Do not** use abrasives as they may damage the glass or seal.

## CLEANING THE GRILL AND OVEN FURNITURE

All removable parts, except the grill pan handle can be washed in the dishwasher.

The grill pan, grill pan grid and oven shelves may be cleaned using a soap impregnated steel wool pad. Soaking first in hot soapy water will make cleaning easier.

## REPLACING AN OVEN LIGHT BULB (MAIN OVEN)

The type of bulb required is a 300°C 25 watt small Edison Screw.

---

 **Disconnect the appliance from the electricity supply before replacing the bulb.**

---

1. Make sure the appliance is cool before replacing the bulb.
2. Open the oven door and remove the shelves and wirework runners.
3. Pull the glass bulb cover towards you and then pull it off. If necessary, use a screwdriver to carefully lever off the cover, taking care not to damage the oven cavity.
4. Unscrew the bulb by turning it to the left.
5. Fit a new bulb and then replace the glass bulb cover.
4. Refit the wirework runners and replace the oven shelves.
5. Restore the electricity supply and reset the time of day.

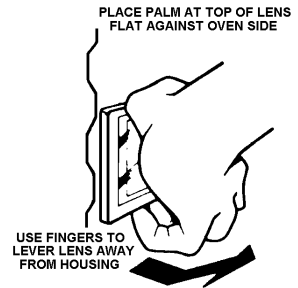

## REPLACING AN OVEN LIGHT BULB (TOP OVEN)

The type of bulb required is a 300°C 25 watt small Edison Screw.

---

 **Disconnect the appliance from the electricity supply before replacing the bulb.**

---

1. Make sure the appliance is cool before replacing the bulb.
2. Open the door and remove the shelves and wirework runners.
3. Remove the glass cover by turning it to the left.
4. Unscrew the bulb by turning it to the left.
5. Fit a new bulb and then replace the glass bulb cover.
6. Refit the wirework runners and replace the oven shelves.
7. Restore the electricity supply and reset the time of day.

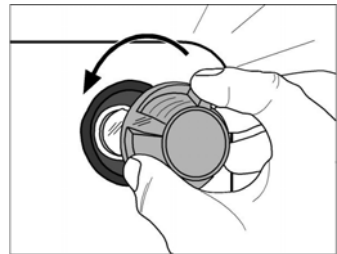

# SOMETHING NOT WORKING

Please carry out the following checks on your appliance before calling a Service Engineer. It may be that the problem is a simple one which you can solve yourself without the expense of a service call.

In-guarantee customers should make sure that the checks have been made as the engineer will make a charge if the fault is not a mechanical or electrical breakdown.

Please note that proof of purchase is required for in-guarantee service calls.

PROBLEM	POSSIBLE SOLUTION
The grill, ovens and timer do not work.	Check that the appliance has been wired in to the appliance supply and is switched on at the wall. Check that the main appliance fuse is working.
	If you have checked the above: Allow the appliance to cool for a couple of hours. The appliance should now be working normally.
The grill and top oven work but the main oven does not.	Check that the time of day has been set on the clock. Check that the oven is set for manual cooking.
The grill does not work or cuts out after being used for a long period of time.	Ensure the cooling fan is running when the grill is on. If the cooling fan fails, the grill will not operate correctly. Contact your local Service Force Centre. Leave the grill door open and allow the grill to cool. After a couple of hours check that the grill works as normal
The timer does not work.	Check that the instructions for the operation of the timer are being closely followed.
The indicator neons are not working correctly.	Check that you have selected only the function you require. Ensure all other controls are in the Off position.
The oven is not cooking evenly.	Check that the appliance is correctly installed and is level. Check that the recommended temperatures and shelf positions are being used.
The oven light fails to illuminate.	The oven light bulb may need replacing. If the Main Oven is set for automatic cooking the light will illuminate when the cook time begins.
The oven fan is noisy.	Check that the oven is level. Check that the shelves and bakeware are not vibrating in contact with the oven back panel.
The oven temperature is too high or too low.	Check that the recommended temperatures and shelf positions are being used. Be prepared to adjust the temperature up or down by 10°C to achieve the results you want.

# Guarantee / Customer care

## Standard guarantee conditions

We, Electrolux, undertake that if within 12 months of the date of the purchase this Electrolux appliance or any part thereof is proved to be defective by reason only of faulty workmanship or materials, we will, at our option repair or replace the same FREE OF CHARGE for labour, materials or carriage on condition that:

- The appliance has been correctly installed and used only on the electricity supply stated on the rating plate.
- The appliance has been used for normal domestic purposes only, and in accordance with the manufacturer's instructions.
- The appliance has not been serviced, maintained, repaired, taken apart or tampered with by any person not authorised by us.
- Electrolux Service Force Centre must undertake all service work under this guarantee
- Any appliance or defective part replaced shall become the Company's property.
- This guarantee is in addition to your statutory and other legal rights.

## Exclusions

- Damage or calls resulting from transportation, improper use or neglect, the replacement of any light bulbs or removable parts of glass or plastic.
- Costs incurred for calls to put right an appliance which is improperly installed or calls to appliances outside the United Kingdom.
- Appliances found to be in use within a commercial environment, plus those which are subject to rental agreements.
- Products of Electrolux manufacturer that are not marketed by Electrolux

## Service and Spare Parts

In the event of your appliance requiring service, or if you wish to purchase spare parts, please contact your local Service Force Centre by telephoning

**0870 5 929 929**

Your telephone call will be automatically routed to the Service Force Centre covering your postcode area.

For the address of your local Service Force Centre and further information about Service Force, please visit the website at

[www.serviceforce.co.uk](http://www.serviceforce.co.uk)

Before calling out an engineer, please ensure you have read the details under the heading "Something not working"

When you contact the Service Force Centre you will need to give the following details:

1. Your name, address and postcode.
2. Your telephone number.
3. Clear concise details of the fault.
4. The model and Serial number of the appliance (found on the rating plate).

5. The purchase date.

Please note a valid purchase receipt or guarantee documentation is required for in guarantee service calls.

## Customer Care

For general enquiries concerning your Electrolux appliance, or for further information on Electrolux products please contact our Customer Care Department by letter or telephone at the address below or visit our website at [www.electrolux.co.uk](http://www.electrolux.co.uk)

Customer Care Department  
Electrolux Major Appliances  
Addington Way  
Luton  
Bedfordshire, LU4 9QQ  
Tel: 08705 950 950 (\*)

(\*) Calls may be recorded for training purposes

For Customer Service in Ireland please contact us at the address below:

AEG-Electrolux  
Electrolux Group (Irl) Ltd  
Long Mile Road  
Dublin 12  
Republic of Ireland

Tel: +353 (0) 1 4090754

Email: [service.eid@electrolux.ie](mailto:service.eid@electrolux.ie)

# EUROPEAN GUARANTEE

This appliance is guaranteed by Electrolux in each of the countries listed below for the period specified in the appliance guarantee or otherwise by law. If you move from one of these countries to another of the countries listed below the appliance guarantee will move with you subject to the following qualifications: -

- The appliance guarantee starts from the date you first purchased the appliance which will be evidenced by production of a valid purchase document issued by the seller of the appliance.
- The appliance guarantee is for the same period and to the same extent for labour and parts as exists in your new country of residence for this particular model or range of appliances.

- The appliance guarantee is personal to the original purchaser of the appliance and cannot be transferred to another user.
- The appliance is installed and used in accordance with instructions issued by Electrolux and is only used within the home, i.e. is not used for commercial purposes.
- The appliance is installed in accordance with all relevant regulations in force within your new country of residence.

The provisions of this European Guarantee do not affect any of the rights granted to you by law

[www.electrolux.com](http://www.electrolux.com)

		
Albania	+35 5 4 261 450	Rr. Pjeter Bogdani Nr. 7 Tirane
Belgique / België / Belgien	+32 2 363 04 44	Bergensesteenweg 719, 1502 Lembeek
Česká republika	+420 2 61 12 61 12	Budějovická 3, Praha 4, 140 21
Danmark	+45 70 11 74 00	Sjællandsgade 2, 7000 Fredericia
Deutschland	+49 180 32 26 622	Muggenhofer Str. 135, 90429 Nürnberg
Eesti	+37 2 66 50 030	Mustamäe tee 24, 10621 Tallinn
España	+34 902 11 63 88	Carretera M-300, Km. 29,900 Alcalá de Henares Madrid
France	<a href="http://www.electrolux.fr">www.electrolux.fr</a>	
Great Britain	+44 8705 929 929	Addington Way, Luton, Bedfordshire LU4 9QQ
Hellas	+30 23 10 56 19 70	4, Limnou Str., 54627 Thessaloniki
Hrvatska	+385 1 63 23 338	Slavonska avenija 3, 10000 Zagreb
Ireland	+353 1 40 90 753	Long Mile Road, Dublin 12
Italia	+39 (0) 434 558500	C.so Lino Zanussi, 26 - 33080 Porcia (PN)
Latvija	+37 17 84 59 34	Kr. Barona iela 130/2, LV-1012, Riga
Lituania	+370 5 27 80 609	Verkiu 29, 09108 Vilnius, Lithuania
Luxembourg	+35 2 42 43 13 01	Rue de Bitbourg, 7, L-1273 Hamm
Magyarország	+36 1 252 1773	H-1142 Budapest XIV, Erzsébet királyné útja 87
Nederland	+31 17 24 68 300	Vennootsweg 1, 2404 CG - Alphen aan den Rijn
Norge	+47 81 5 30 222	Risløkkvn. 2., 0508 Oslo
Österreich	+43 18 66 400	Herziggasse 9, 1230 Wien
Polska	+48 22 43 47 300	ul. Kolejowa 5/7, Warsaw
Portugal	+35 12 14 40 39 39	Quinta da Fonte - Edifício Gonçalves Zarco - Q 35 -2774-518 Paço de Arcos
Romania	+40 21 44 42 581	B-dul Timisoara 90, S6, Bucharest
Schweiz - Suisse - Svizzera	+41 62 88 99 111	Industriestrasse 10, CH-5506 Mägenwil
Slovenija	+38 61 24 25 731	Tržaška 132, 1000 Ljubljana
Slovensko	+421 2 43 33 43 22	Electrolux Slovakia s.r.o., Electrolux Domáce spotrebiče SK, Seberínho 1, 821 03 Bratislava
Suomi	+35 8 26 22 33 00	Konepajaranta 4, 28100 Pori
Sverige	+46 (0) 771 76 76 76	Electrolux Service, St Göransgatan 143, S-105 45 Stockholm
Türkiye	+90 21 22 93 10 25	Tarlabası caddesi no: 35 Taksim İstanbul
Россия	+7 095 937 7837	129090 Москва, Олимпийский проспект, 16, БЦ "Олимпик"

# TECHNICAL DETAILS

Voltage: 230-240 Volts AC 50Hz

Wattage: 5.0-5.4kW

Height: 897mm

Width: 592mm

Depth: 563mm

(excluding handles and knobs)

Weight: 55kg



This appliance complies with: European Council Directive 73/23/EEC.  
EMC Directive 89/336/EEC.  
CE Marking Directive 93/68/EEC.

	Manufacturer	ELECTROLUX	
	Model Number	EDOM	
Top Oven	Energy Efficiency on a Scale A (more efficient) to G (less efficient) (4)		B
	Energy Consumption in kWh (1)	Conventional	0,74
		Forced air Convection	
	Useable Volume - Litres		31
	Oven Size (2)		Small
	Time Taken to 'Cook' Standard Load - Minutes	Conventional	42
		Forced air Convection	
The Area of the largest Baking Sheet - cm <sup>2</sup> (3)		1470	
Bottom Oven	Energy Efficiency on a Scale A (more efficient) to G (less efficient) (5)		A
	Energy Consumption in kWh (1)	Conventional	
		Forced air Convection	0,79
	Useable Volume - Litres		57
	Oven Size (2)		Medium
	Time Taken to 'Cook' Standard Load - Minutes	Conventional	
		Forced air Convection	42
The Area of the largest Baking Sheet - cm <sup>2</sup> (3)		1470	

(1) Based on test results for a standard load in accordance with EN50304

(2) Small: 125-350 Medium: 350-650 Large: 650+

(3) Surface Area of Shelf

(4) Conventional Function unless stated

(5) Forced Air Convection Function unless stated

# INSTALLATION INSTRUCTIONS

## WARNINGS



- This appliance must be installed by a qualified electrician/competent person. Safety may be impaired if installation is not carried out in accordance with these instructions.
- This appliance must be earthed.
- Do not remove the screws from the earth tab extending from the oven mains terminal block (Fig. 1).
- Before connecting the appliance make sure that the voltage of your electricity supply is the same as that indicated on the rating plate. This is situated on the lower front frame of the appliance and can be seen upon opening the door. Alternatively the rating plate may also be found on the back or top of some models (where applicable).
- Do not alter the electrical circuitry of this appliance.

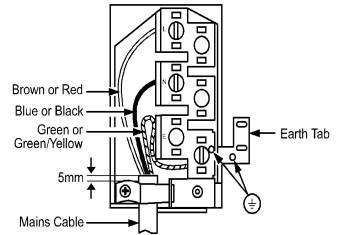

Fig.1

## THINGS TO NOTE

- This appliance is designed to be fitted in cabinets of the recommended dimensions as shown (Fig.3).
- If your cabinet interior dimension is between 565-570mm the oven may still be fitted. However, a minor modification to the cabinet will be required to reduce the aperture size down to 560-565 mm, to allow the product to be securely screwed into the cabinet.
- The dimensions given provide adequate air circulation around the unit within the cabinet, ensuring compliance with BS EN60-335.
- Enquiries regarding the installation of the cooker point, if required, should be made to your Regional Electricity Company to ensure compliance with their regulations.
- The appliance socket switch should be outside the cabinet but within 2m of the appliance to make it accessible to switch off the appliance in case of an emergency.
- To protect the hands, wear gloves when lifting the oven into its housing.



Do not lift the appliance by the handles.

## NOTE: HOUSE CIRCUIT

Earth leakage and continuity tests must be carried out before the appliance is connected to the mains supply and re-checked after fitting.

## CHOICE OF ELECTRICAL CONNECTION

- There are three possible ways to connect your appliance. In each case the appliance should be operated using at least 6mm<sup>2</sup> twin core and earth PVC insulated. Please choose from the most appropriate after reading the different methods:-
- a) By connecting the appliance to a cooker point (having a double pole isolating switch with at least 3mm contact separation in all poles and neutral) and protected with a fuse or miniature circuit breaker at your mains fuse box.

**Subject to Regional Electricity Companies regulations if you wish to connect the oven and hob to the power supply you may use one of the following two methods:-**

- b) By connecting the appliance together with a hob directly to a cooker point(s). Having a double pole isolating switch with at least 3mm contact separation in all poles and neutral.
- c) If you wish to connect an oven and a hob to a cooker point you can by connecting the oven and hob separately to the cooker point. Oven and hob units should be separately connected to a cooker point. See Fig. 2.

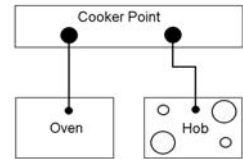

Fig. 2

NOTE: It is good practice to :

- Fit an Earth Leakage Circuit Breaker to your house wiring.
- Wire your appliance to the latest IEE regulations.

## PREPARING CABINET FOR FITTING OF OVEN

- Make sure that the cabinet is the correct size for the appliance to be fitted (Ref. Fig. 3).
- If the size is between 565-570mm, then the cabinet should be modified so that at the screw fixing points the recommended dimension of at least 560-565mm is maintained. The modification should ideally be localised to ensure that after screw fitment the oven is **securely** fixed into position.
- The cabinet must be stable and level by firmly securing it to the wall or floor. If necessary, make arrangements to ensure the shelf upon which the oven will rest is level.
- When the appliance is installed ensure a minimum gap of 2mm is maintained between the trim on the bottom edge of the appliance, and any corresponding door / panel underneath.



# RECOMMENDED CABINET DIMENSIONS (IN MILLIMETRES)

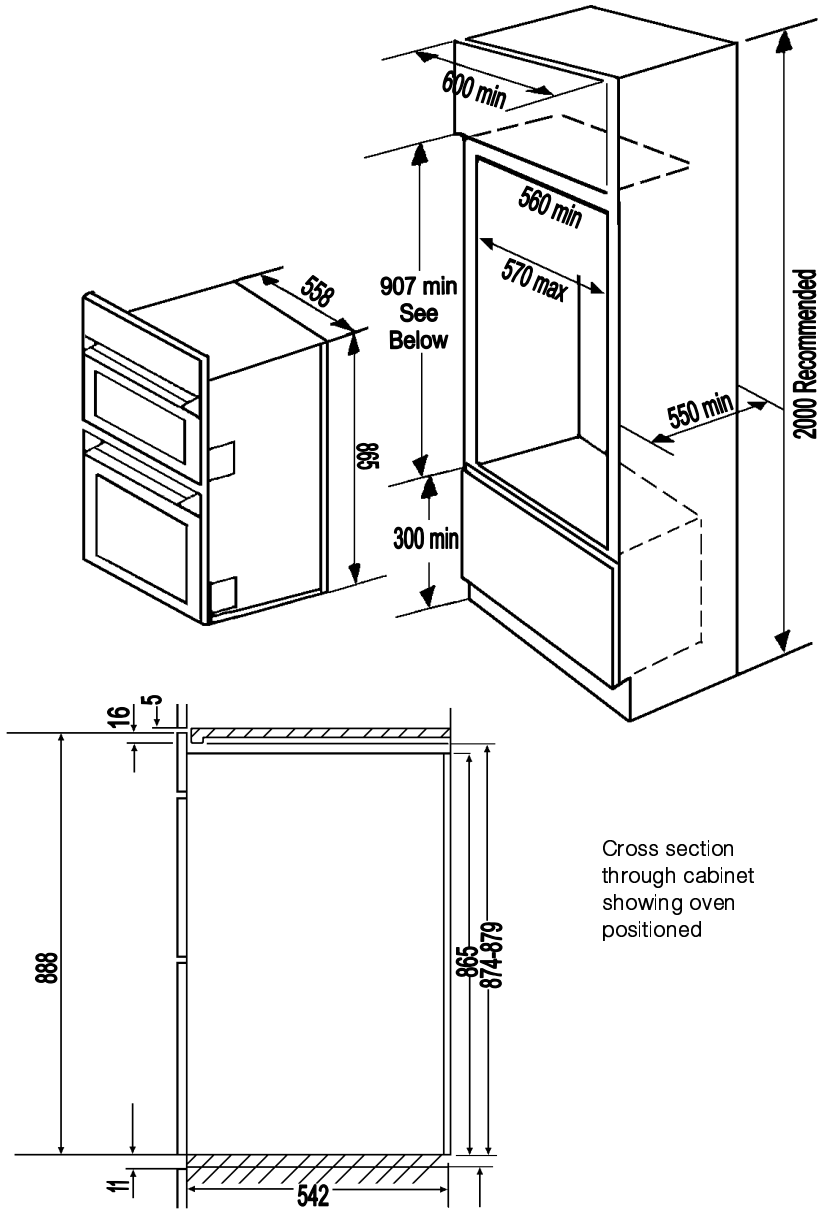

Fig. 3 Built In Installation

## HOW TO FINISH UNPACKING

- Place packed appliance next to the space in which it will be installed.
- Remove the appliance packing except for bottom tray, which should be left in position until the appliance is ready to be fitted into its cabinet.

**NOTE:** It is imperative that the appliance is left in the base to protect both the appliance and the floor.

- Ensure the user is given these operating instructions.



**Important:** Switch off at the mains, miniature circuit breaker and if appropriate, remove fuse before commencing any electrical work.

## TO REMOVE COVER OF MAINS TERMINAL

From the rear of the appliance, remove mains input terminal cover to gain access to terminal block.

- First remove retaining screw with pozidrive screwdriver. See Fig. 4.
- Prise cover loose using screwdriver in position (1) then lever off with screwdriver in position (2) at either side. See Fig. 5.
- Lift cover and remove screw from cable clamp. See Fig. 6.

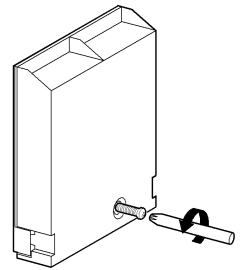

Fig. 4

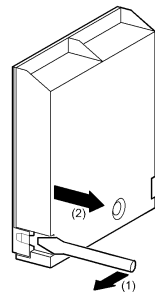

Fig.5

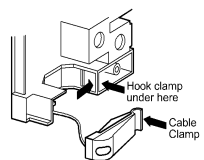

Fig.6

## CONNECTING TO THE MAINS TERMINAL



**Warning:** This appliance must be earthed.

- We recommend you use a new length of 6mm<sup>2</sup> twin core and earthed cable to ensure your safety.
- Make connection as shown in Fig. 7 by proceeding as follows:-
- Preform wires to the appropriate shape to suit fitting into the mains terminal block.
- Strip inner insulation on wires using wirestrippers.
- Twist the bared wires using pliers.
- Cut bared wires 10mm away from the end of the inner insulation. Where uninsulated Earth wires are used ensure they are suitably sheathed to leave 10mm bare wire to fit into the terminal.
- Clamp bare wires into the relevant terminal and check they are held by tugging each one in turn.
- Clamp the mains cable securely ensuring 5mm of the outer insulation is inside the terminal block and that the wires are not taught but not so slack as to cause any fouling. See Fig. 7.
- Place fuse/miniature circuit breaker in circuit and switch on at mains.

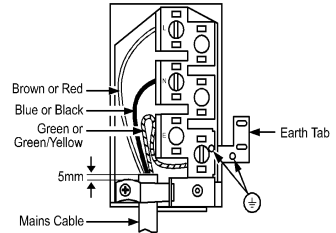

Fig.7

## CHECKING ELECTRICAL CONNECTIONS

Correct electrical connection can be confirmed when switching on the appliance as the timer will be flashing.

### NOTE: HOUSE CIRCUIT

Earth leakage and continuity tests must be carried out before the appliance is connected to the mains supply and re-checked after fitting.

## CONNECTING TO A HOB OR COOKER POINT

- Either follow in general terms the instructions for connecting to the terminal block or refer to the hob suppliers installation instructions.



Feed the cable through the cabinet and arrange to route the cable away from the appliance which may become hot.

## FITTING INTO THE CABINET



**IMPORTANT:** Ensure that the oven is switched off at the wall before any further work is carried out.

- Using a tape measure establish the internal width of the cabinet. Refer to page 29 if greater than 565mm.
- Position the appliance in front of the cabinet. See Fig. 8.
- Take out all oven furniture before installation to reduce the weight you need to lift. The oven door should be taped up to keep it closed whilst lifting.
- To place the appliance into the cabinetry follow the procedure below:
- **N.B. Two people will be required to carry out the lifting procedure.**



**Warning:** Do not attempt to lift this appliance by the handle(s).

- a) Each person should squat either side of the appliance.
- b) Tilt the appliance so that your hands can support the underside of the appliance.
- c) Keeping your back straight, raise the appliance to the correct height by straightening at the knees.
- d) Rest the rear underside of the appliance on the cabinet floor while your hands support the front.
- e) The appliance can be pushed fully into the cabinet. Take care to avoid fouling the mains lead.
- f) Ensure the appliance is central and level.
- g) **Do not** remove spacers fitted behind fixing holes.
- h) When the appliance is fully housed screw the stability screws (supplied with the appliance) into the side of the cabinet taking care not to distort the side trims (See Fig 9). It is advisable to turn each screw alternatively to avoid damaging the trims.
- i) Switch on the appliance then refer to the operating instructions.

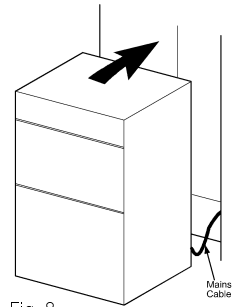

Fig. 8

Fixing points for stability screws

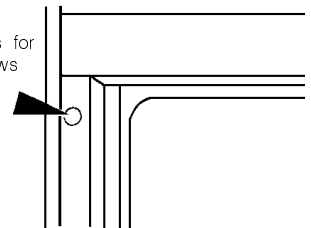

Fig. 9







[www.electrolux.com](http://www.electrolux.com)

[www.electrolux.co.uk](http://www.electrolux.co.uk)