

PORTABLE CD, CD-R / RW PLAYER
with CASSETTE RECORDER
and AM / FM STEREO RADIO



OWNER'S MANUAL

PD6537



Visit our web site at www.emersonradio.com

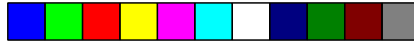



CAUTION

TO PREVENT FIRE OR SHOCK HAZARD, DO NOT USE THIS PLUG WITH AN EXTENSION CORD, RECEPTACLE OR OTHER OUTLET UNLESS THE BLADES CAN BE FULLY INSERTED TO PREVENT BLADE EXPOSURE. TO PREVENT FIRE OR SHOCK HAZARD, DO NOT EXPOSE THIS APPLIANCE TO RAIN OR MOISTURE.

 <p>The lightning flash with arrow-head symbol, within an equilateral triangle is intended to alert the user to the presence of uninsulated 'dangerous voltage' within the product's enclosure that may be of sufficient magnitude to constitute a risk of electric shock to persons.</p>	<p>CAUTION RISK OF ELECTRIC SHOCK DO NOT OPEN</p> <p>WARNING: TO REDUCE THE RISK OF ELECTRIC SHOCK DO NOT REMOVE COVER (OR BACK), NO USER SERVICEABLE PARTS INSIDE REFER SERVICING TO QUALIFIED SERVICE PERSONNEL.</p>	 <p>The exclamation point within an equilateral triangle is intended to alert the user to the presence of important operating and maintenance (servicing) instructions in the literature accompanying the appliance.</p>
--	---	---

IMPORTANT SAFETY INSTRUCTIONS

- 1.) Read these instructions.
- 2.) Keep these instructions.
- 3.) Heed all warnings.
- 4.) Follow all instructions.
- 5.) Do not use this apparatus near water.
- 6.) Clean only with dry cloth.
- 7.) Do not block any ventilation openings. Install in accordance with the manufacturer's instructions.
- 8.) Do not install near any heat sources such as radiators, heat registers, stoves, or other apparatus (including amplifiers) that produce heat.
- 9.) Do not defeat the safety purpose of the polarized or grounding-type plug. A polarized plug has two blades with one wider than the other. A grounding type plug has two blades and a third grounding prong. The wide blade or the third prong are provided for your safety. If the provided plug does not fit into your outlet, consult an electrician for replacement of the obsolete outlet.
- 10.) Protect the power cord from being walked on or pinched particularly at plugs, convenience receptacles, and the point where they exit from the apparatus.
- 11.) Only use attachments / accessories specified by the manufacturer.
- 12.) Unplug this apparatus during lightning storms or when unused for long periods of time.
- 13.) Refer all servicing to qualified service personnel. Servicing is required when the apparatus has been damaged in any way, such as power-supply cord or plug is damaged, liquid has been spilled or objects have fallen into the apparatus, the apparatus has been exposed to rain or moisture, does not operate normally, or has been dropped.
- 14.) This appliance shall not be exposed to dripping or splashing water and no object filled with liquids such as vases shall be placed on the apparatus.
- 15.) Do not overload wall outlet. Use only power source as indicated.
- 16.) Use replacement parts as specified by the manufacturer.
- 17.) The product may be mounted to a wall only if recommended by the manufacturer.
- 18.) Upon completion of any service or repairs to this product, ask the service technician to perform safety checks.



BEFORE WE BEGIN

Thank you for purchasing this Emerson audio product. The Emerson brand is your assurance of quality, performance and value.

Our engineers have included many useful and convenient features in this product. Please be sure to read this Owner's Manual completely to make sure you are getting the maximum benefit from each feature.

This product was manufactured using the highest quality components and standards of workmanship. It was tested by Emerson inspectors and found to be in perfect working order before it left our factory. However, there is always the chance that some problem may occur because of rough handling during shipment to the retail store or to the final consumer.

If, after reading this Manual, you experience any problems with the operation of this product, please refer to the instructions for obtaining service at the end of this Manual. Emerson and Emerson retailers are committed to your satisfaction.

Once again, thanks for purchasing this Emerson audio product.

For future reference, record the serial number in the space provided.

Model No: PD6537

Serial No: _____



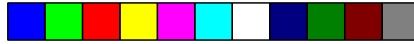

IMPORTANT NOTES

- Avoid installing this unit in places exposed to direct sunlight or close to heat radiating appliances such as electric heaters, on top of other stereo equipment that radiates too much heat, places lacking ventilation or dusty areas, places subject to constant vibration and/or humid or moist areas.
- Do not attempt to clean this unit with chemical solvents as this might damage the finish. Use a clean dry cloth.
- Operate controls and switches as described in the manual.
- Before turning 'On' the power, make certain that power cord is properly installed.
- Store your CDs, cassettes in a cool area to avoid damage from heat.
- When moving the set, be sure to first disconnect the power cord.

CLASS 1 LASER PRODUCT

CLASS 1 LASER PRODUCT
APPAREIL À LASER DE CLASSE 1
PRODUCTO LASER DE CLASE 1

CAUTION
INVISIBLE LASER RADIATION
WHEN OPEN AND INTERLOCKS
DEFEATED.
AVOID EXPOSURE TO BEAM



This product contains a low power Laser Device.

FCC INFORMATION

This equipment has been tested and found to comply with the limits for a Class B digital device, pursuant to Part 15 of the FCC Rules. These limits are designed to provide reasonable protection against harmful interference in a residential installation. This equipment generates, uses, and can radiate radio frequency energy and, if not installed and used in accordance with the instructions, may cause harmful interference to radio communications. However, there is no guarantee that interference will not occur in a particular installation. If this equipment does cause harmful interference to radio or television reception, which can be determined by turning the equipment off and on, the user is encouraged to try to correct the interference by one or more of the following measures:

- Reorient or relocate the receiving antenna.
- Increase the separation between the equipment and receiver.
- Connect the equipment into an outlet on a circuit different from that to which the receiver is connected.
- Consult the dealer or an experienced radio/TV technician for help.

This device complies with Part 15 of the FCC Rules. Operation is subject to the following two conditions:

- (1) This device may not cause harmful interference, and
- (2) This device must accept any interference received, including interference that may cause undesired operation.



PREPARATION FOR USE

UNPACKING AND SET UP

- Carefully remove the unit from the carton and remove all packing materials from the unit.
- Carefully remove any small strips of tape which may have been used to keep the CD and Cassette doors closed during shipment.
- Open the CD compartment by pressing the OPEN button on top panel and lifting upward. Inside the CD compartment you will see a white transit card which is used to prevent the laser pick-up from moving during shipment. Carefully remove this card and close the CD compartment door.
- Please save the carton and packing materials in the event that your unit ever needs to be returned for service. The original carton and packing materials are the only way to protect the unit from damage during shipment.

POWER SOURCES

This unit is designed to operate on 8 pcs "C" batteries, not included, or on normal 120V 60Hz AC house current. Operating this unit from any other power source may cause damage to the unit, and such damage is not covered by your warranty.

AC Operation

Connect the small end of the AC Power Cord to the AC socket on the back cabinet, then insert the plug in any convenient household 120V 60Hz AC outlet.

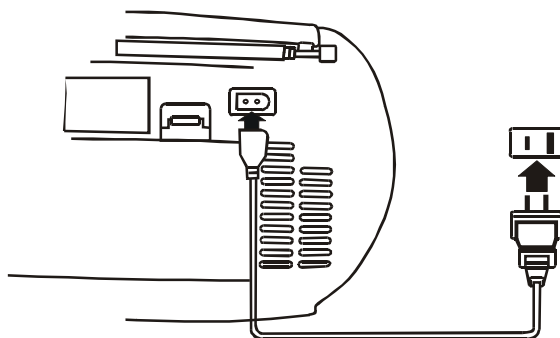

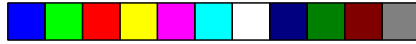

NOTE:

This unit has a polarized AC plug with one wide blade and one narrow blade. This plug will only fit into a matching polarized AC outlet. This is a safety feature to reduce the possibility of electric shock. If this plug will not fit in your AC outlet, you probably have an outdated non-polarized outlet. You should have your outdated outlet changed by a qualified, licensed electrician. Do not file the wide blade on the plug, or use an adapter to make the plug fit into your outlet. This defeats the safety feature and could expose you to electric shock.

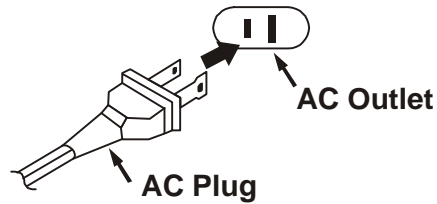

Battery Operation

- 1.) Remove the battery compartment door on the back of the cabinet by pressing down on the two tabs directly below the "▼" marks.
- 2.) Insert 8 pcs "C" size batteries into the battery compartment according to the polarity diagram engraved inside the compartment. If the batteries are inserted incorrectly the unit will not work.
- 3.) Replace the battery compartment door.

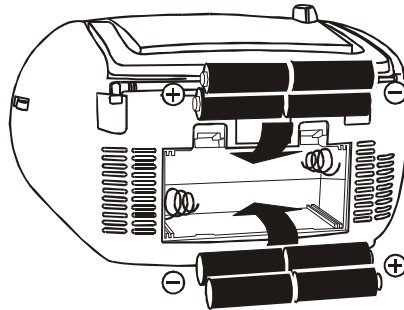
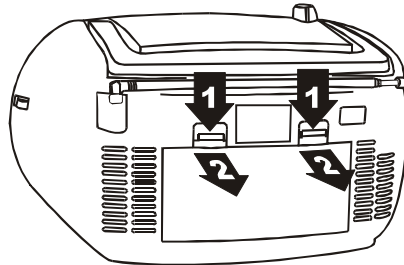

NOTE: In order to operate the unit on battery power the AC cord must be disconnected from the AC socket on the back cabinet.

BATTERY PRECAUTIONS

Follow these precautions when using batteries in this device:

1. Use only the size and type of batteries specified.
2. Be sure to follow the correct polarity when installing the batteries as indicated in the battery compartment. Reversed batteries may cause damage to the device.
3. Do not mix different types of batteries together (e.g. Alkaline and Carbon-Zinc) or old batteries with fresh ones.
4. If the device is not to be used for a long period of time, remove the batteries to prevent damage or injury from possible battery leakage.
5. Do not try to recharge batteries not intended to be recharged; they can overheat and rupture. (Follow battery manufacturer's directions.)

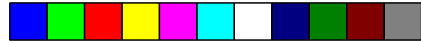

LOCATION OF CONTROLS AND INDICATORS

TOP VIEW

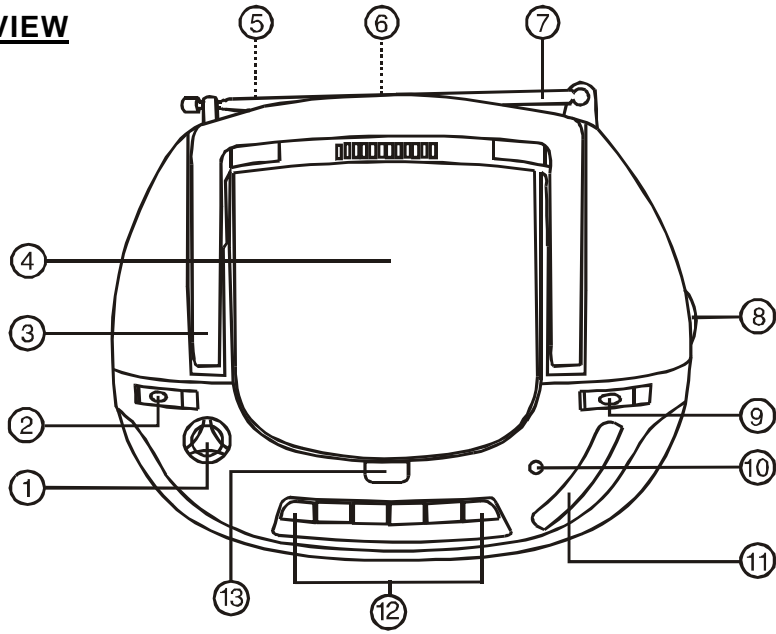

FRONT VIEW

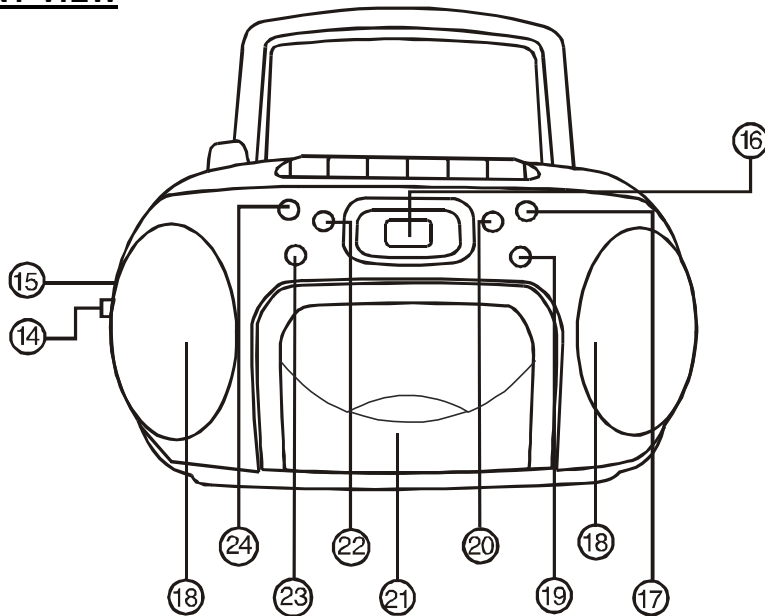

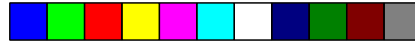

- 1.) VOLUME Control.
- 2.) FUNCTION (TAPE-POWER OFF/RADIO/CD) Selector Switch.
- 3.) Carrying Handle.
- 4.) CD door.
- 5.) AC Cord Socket (Back Cabinet).
- 6.) Battery Compartment (Back Cabinet).
- 7.) FM Telescopic Antenna.
- 8.) TUNING Control.
- 9.) BAND (FM STEREO/FM/AM) Selector Switch.
- 10.) FM STEREO Indicator.
- 11.) Dial Pointer.
- 12.) Cassette Control keys.
(PAUSE **||** / STOP-EJECT **■▲** / F.FWD **◀◀** / REW **▶▶** / PLAY **▶**
/ RECORD **●**)
- 13.) CD door OPEN Button.
- 14.) BEAT CUT Switch.
- 15.) PHONES (Stereo Headphone) Jack.
- 16.) CD Track LCD Display.
- 17.) CD REPEAT Button.
- 18.) Speakers.
- 19.) CD FWD.Skip Search **▶▶** Button.
- 20.) CD PLAY/PAUSE **▶||** Button.
- 21.) Cassette door.
- 22.) CD STOP **■** Button.
- 23.) CD REV.Skip Search **◀◀** Button.
- 24.) CD PROGRAM Button.

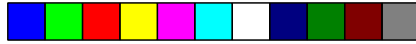

OPERATING INSTRUCTIONS

LISTENING TO THE RADIO

- 1.) Move the FUNCTION selector to the RADIO position.
- 2.) Move the BAND selector to the desired band, FM STEREO, FM or AM.
- 3.) Tune to your desired station with the TUNING control. If you have set the BAND selector to FM STEREO and you tune to a FM Stereo station the FM STEREO LED Indicator will light.
- 4.) Set the VOLUME control to the desired level.
- 5.) When you are finished listening move the FUNCTION selector back to the TAPE (POWER OFF) position to shut the power 'Off' and extend the battery life.

Antenna Information

AM

The AM antenna is inside the cabinet. IF AM reception is unsatisfactory try rotating the entire unit until you find the position that provides the best reception.

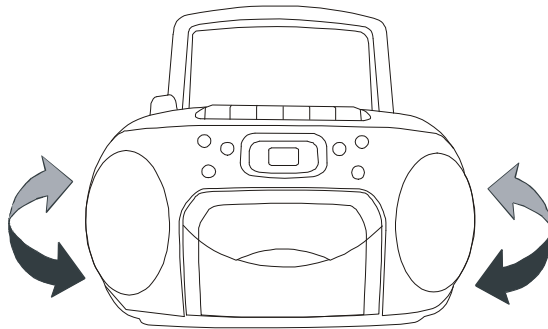

FM

Vary the direction of the FM antenna to find the position that provides the best reception.

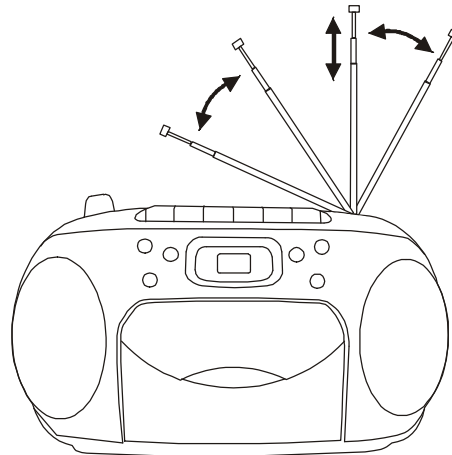

NOTE: If you are listening to a weak FM Stereo station you can usually improve the reception by moving the BAND selector from the FM STEREO position to the FM position, however the sound will now be mono.

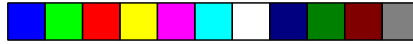

PLAYING COMPACT DISCS

Note: Although this portable CD player can read CD-R and CD-RW discs, in addition to normal CDs, the playability of CD-R and CD-RW discs may be effected by the type of software that was used to create the discs, as well as the quality and condition of the blank media you are using. 100% playability cannot be guaranteed. This is not an indication of a problem with the player.

NORMAL PLAYBACK

- 1.) Move the FUNCTION selector to the CD position.
- 2.) Open the CD door by pressing the OPEN button on the top panel. If you have not already removed the white transit card from the CD player, please remove it now.

- 3.) Place your CD on the center spindle with the printed label side facing up. Close the CD door. The player will read the Table of Contents and the display will show the total number of tracks on the disc. If the disc is damaged or up side down, display shows “_ _”



- 4.) Press the CD PLAY/PAUSE ►|| button to begin playback on Track 1. The PLAY ► Indicator appears in the display .



- To skip to higher or lower numbered tracks during playback press the FWD ►► or REV ◄◄ button repeatedly until the desired track number appears in the display. Playback will begin on the selected track.
- To search rapidly forward or backward during playback to locate a specific portion of a track, depress and hold the FWD ►► or REV ◄◄ button. The player will search rapidly forward or backward as long as the buttons are depressed. Normal speed playback will resume when the buttons are released.
- To Pause momentarily during playback press the PLAY/PAUSE ►|| button again. The sound stops and the PLAY ► Indicator flashes, however the disc continues to spin. To cancel Pause and resume normal playback press the PLAY/PAUSE ►|| button once more. Normal playback resumes and the PLAY ► Indicator stops flashing.

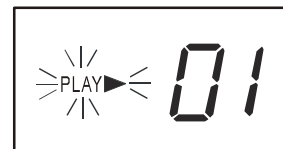

- 5.) Adjust the VOLUME control as desired.



- 6.) To Stop playback at any time press the CD STOP ■ button. The disc stops and the display again shows the total number of tracks on the disc. After the last track has played the disc stops automatically and the display again shows the total number of tracks on the disc.
- 7.) Open the CD door, remove your disc, and close the CD door again.
- 8.) Move the FUNCTION selector to the TAPE (POWER OFF) position to shut the power 'Off'.

TO START PLAYBACK FROM A SPECIFIC TRACK

Insert your disc in the player, close the door, and wait until the display shows the total tracks. Press either the ►► or ◀◀ button until the desired track number appears in the display, then press the PLAY/PAUSE ►|| button to begin playback on that track.

REPEAT PLAYBACK

You can program the player to repeat either a single track or all tracks on the disc continuously. The Repeat feature can be activated while the disc is playing or while the disc is stopped.

One Track Repeat

Press the REPEAT button once. The REPEAT Indicator appears. Select the track you wish to repeat with the ►► or ◀◀ buttons and then press the PLAY/PAUSE ►|| button. The selected track will be repeated continuously.



To cancel One Track Repeat press the STOP ■ button once.

ALL Tracks Repeat

Press the REPEAT button twice. The REPEAT ALL Indicator appears. Press the PLAY/PAUSE ►|| button to begin playback. The entire disc will be repeated continuously.

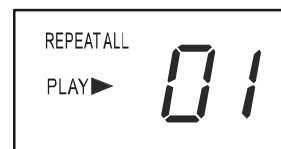

To cancel All Tracks Repeat press the STOP ■ button once.



PROGRAMMED PLAYBACK

You can program up to **19** tracks on a disc to playback in any desired order. You may also program a specific track to play several times within the same program.

Note: *The player cannot be programmed while a disc is playing. If a disc is playing press the STOP ■ button to stop playback before you begin the programming steps below.*

1.) Move the FUNCTION selector to CD, insert your disc in the player, close the door, and wait until the total track number appears in the display.

2.) Press the CD PROGRAM button once. The PROGRAM Indicator and program memory "00" begin flashing in the display.

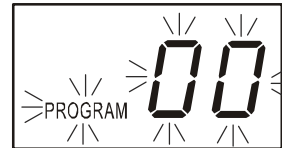

3.) Use the ►►/◄◄ buttons to select the first track to be programmed. (Example: Track 08).

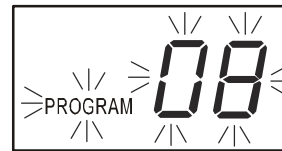

4.) When track number "08" flashes in the display, press the PROGRAM button once again to enter the track "08" in program memory number "01". Track number "08" disappears and "00" flashes again in the display, indicating that you may now select a track to be entered in program memory number "02".

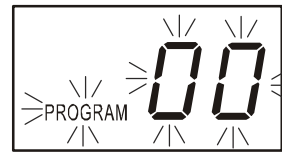

5.) Use the ►► or ◄◄ buttons to select the next track to be programmed. When the desired track number appears in the display press the PROGRAM button again to enter that track in the program memory.

6.) Repeat Step 5 until you have entered up to 19 tracks in the program memory. When the memory is full, the "– –" flashes in the LCD display

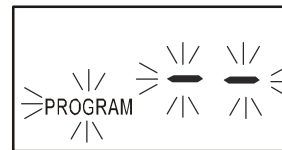

7.) To begin programmed playback press the PLAY/ PAUSE ►◄ button. The LCD display will show the first programmed track and playback will begin on that track. The PROGRAM Indicator flashes.

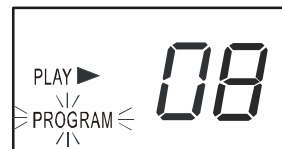

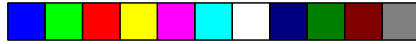

After the last programmed track has played the player stops but the programmed tracks remain in the memory. To play the programmed tracks again, press the PROGRAM button and then the PLAY/PAUSE ►|| button.



To cancel the programmed sequence from memory, press the STOP ■ button at programming mode, open the CD door, or move the FUNCTION selector to the TAPE (POWER OFF) position.

Program Repeat Playback

You can use the Program and Repeat features together to continuously repeat a programmed sequence of tracks. First, program the desired tracks according to Steps 1 through 7 in previous page. When Programmed Playback begins press the REPEAT button twice to activate the All Tracks Repeat feature. The REPEAT ALL Indicator appears in LCD display and all the tracks in your programmed sequence will be repeated continuously.

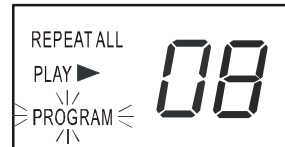

To cancel Programmed Repeat Playback press the STOP ■ button until both the PROGRAM and REPEAT Indicators go 'Off'.

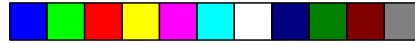

PLAYING CASSETTE TAPES

- 1.) Open the cassette door by pressing the STOP ■ / EJECT ▲ key.
- 2.) Place a pre-recorded cassette tape into the slots on the inside of the door with the exposed tape facing up and the full reel on the right side.

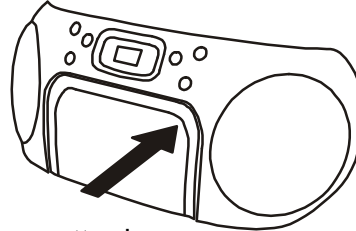
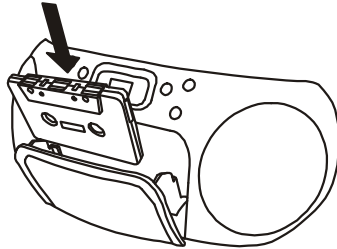

Close cassette door.

- 3.) Move the FUNCTION selector to the TAPE position.
- 4.) Press the cassette PLAY ◀ key to begin playback.
- 5.) Set the VOLUME control as desired.
- 6.) To advance the tape rapidly press the F. FWD ◀◀ key. To stop the tape before it ends press the STOP ■ /EJECT ▲ key.
- 7.) To rewind the tape rapidly press the REW ▶▶ key. To stop the tape before it ends press the STOP ■ /EJECT ▲ key.
- 7.) When the tape ends the Automatic Stop System releases the PLAY ◀ key and shuts off the tape motor. You may then open the cassette door, remove your tape, turn it over and play the other side if desired.
- 8.) When you are finished listening stop the tape, open the door, remove the tape and close the door. If you are playing a tape and then switch to the RADIO or CD function be sure to press the STOP ■ /EJECT ▲ key to disengage the tape mechanism. This prevents excess wear and tear on the mechanism.

IMPORTANT:

Always press the STOP ■ /EJECT ▲ key to shut off the tape motor before opening the cassette door to remove your tape. The Automatic Stop System does not function in the F. FWD ◀◀ and REW ▶▶ modes. When the tape ends in the F. FWD ◀◀ and REW ▶▶ modes the motor continues to run. You must press the STOP ■ /EJECT ▲ key to shut off the motor before opening the door to remove your tape.



MAKING A TAPE RECORDING

This model allows you to make tape recordings directly from the CD player, or the radio.

- Refer to “PLAYING COMPACT DISCS” if necessary to operate the CD player.
- Refer to “LISTENING TO THE RADIO” if necessary to tune in the station you wish to record from radio.

- 1.) Press the STOP ■ /EJECT ▲ key to open the cassette door.
- 2.) Insert a good quality blank cassette tape into the slots on the cassette door with the open end facing up and the full reel on the right. Use normal tape only. Do not use tape identified as “CrO₂” (Chrome) or “Metal” tape formulations. For best results use tapes of 60 minutes (C-60) or less. Do not use 90 minute or 120 minute tapes as these thinner tapes are more likely to jam in the mechanism.
- 3.) Close the cassette door.
- 4.) When you are ready to start recording press the RECORD ● key. The PLAY ◀ key will also engage. The CD you are playing, or radio program you selected will be recorded directly on to the tape.
- 5.) Press the PAUSE || key during recording to stop the tape temporarily and avoid recording unwanted material such as radio commercials.
- 6.) When you have finished recording press the STOP ■ /EJECT ▲ key to stop and remove the tape.

BEAT CUT SWITCH (On Left Side Cabinet)

Occasionally when recording from the AM radio a repetitive whistle or ‘beat’ sound may be heard. If this occurs slide the BEAT CUT switch to its other position to eliminate the unwanted sound.

Automatic Recording Volume Level Control

This unit has an Automatic Level Control (ALC) circuit which controls the recording volume level and prevents overloaded and distorted recordings. The VOLUME control has no effect on recording volume level. You may change the VOLUME control setting during the recording or even reduce the volume level to “Minimum”. This will not effect the level of the recording.



STEREO HEADPHONE JACK

Connect a set of stereo headphones (not included) with a 3.5mm mini plug to the PHONES jack (located at left side cabinet) for private listening without disturbing others. Before putting on the headphones reduce the VOLUME control to a low level, then put the headphones on and gradually increase the VOLUME control to a comfortable listening level. The built in speakers are automatically disconnected when headphones are connected to the headphone jack.



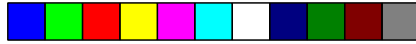

CARE AND MAINTENANCE

ABOUT CASSETTE TAPES

Whenever you record on a cassette any previously recorded material is erased as the new material is recorded. To prevent you from accidentally erasing material which you wish to save, blank cassettes are equipped with erase prevention tabs for each side of the tape. If the erase prevention tab for side A is removed, you cannot accidentally record on side A. The record key cannot be depressed if the erase prevention tab on the cassette has been removed.

To prevent accidental erasing on side A of a cassette use a small screw driver or similar tool to break off the erase prevention tab for side A. This prevents the record key from locking.

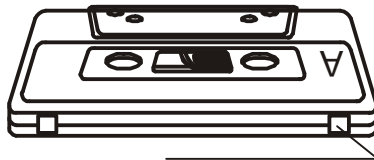

TAB FOR SIDE A
BREAK OUT TO PREVENT RECORDING

If later you do wish to record on side A of the cassette, cover the tab opening with a piece of cellophane tape. This will allow the record key to function again.

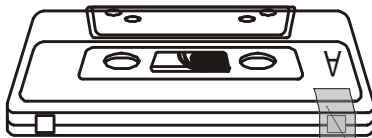

COVER OPENING WITH TAPE
IN ORDER TO RECORD AGAIN.



CASSETTE CARE

Two common causes of trouble experienced when using cassettes are:

- 1.) Tape jamming — Leading to uneven speed in playback, and
- 2.) Tape tangling — Where the tape wraps itself around vital parts of the mechanism.

To reduce the likelihood of these problems occurring, the following precautions should be observed:

- Check that there are no loose layers of tape visible through the cassette center window (see Fig. 1). Take up any loose layers, using a pencil or hexagonal barrelled ballpoint pen, before inserting the cassette into the machine (see Fig. 2).
- If the cassette feels “tight” while performing operation shown (see Fig. 2), the tape may be jamming due to “ridges” formed in the winding of the tape (visible through the center window). These may be removed, in most cases, by fast winding of the cassette from one end to the other and back again.
- Use only well-known brands of tape. Avoid use of C-120 cassettes.

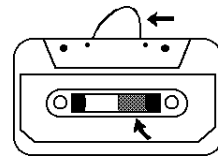

Fig.1

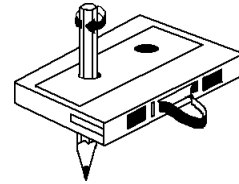

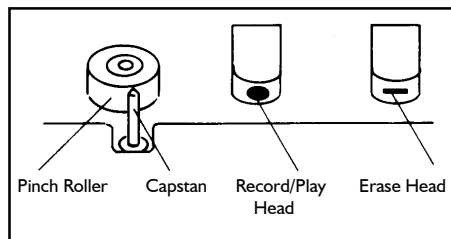

Fig.2

Furthermore, do not expose cassettes to direct sunlight, dust or oil, and do not touch the tape surfaces.

HEAD CLEANING

The tape heads, pinch roller and capstan require periodic cleaning. This removes particles of the metal oxide coating that wear off the tape and accumulate on these parts and impair performance. Switch off the power, press the STOP/EJECT  key to open the cassette door, and press the PLAY  key. Clean the tape heads, pinch roller and capstan with a soft cloth or cotton pad dampened in isopropyl alcohol or special tape head cleaner.



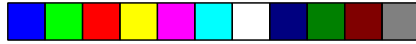

COMPACT DISC CARE

- To remove a disc from its storage case, press down on the center of the case and lift the disc out, holding it carefully by the edges.

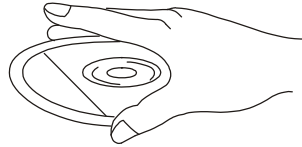
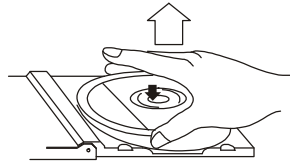

- Fingerprints and dust should be carefully wiped off the disc's recorded surface with a soft cloth. Unlike conventional records, compact discs have no grooves to collect dust and microscopic debris, so gently wiping with a soft cloth should remove most particles. Wipe in a straight line from the inside to the outside of the disc. Small dust particles and light stains will have absolutely no effect on reproduction quality.

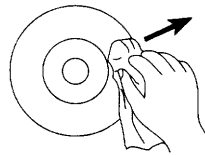
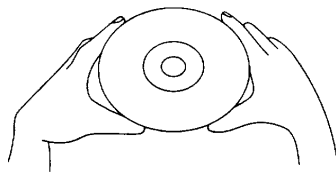

- Clean the disc periodically with a soft, lint-free, dry cloth. Never use detergents or abrasive cleaners to clean the disc. If necessary, use a CD cleaning kit.
- Never write on or affix labels to the surface of compact discs.

CARE OF THE CABINET

If the cabinet becomes dusty wipe it with a soft dry dust cloth. Do not use any wax, polish sprays, or abrasive cleaners on the cabinet.

CAUTION

Never allow any water or other liquids to get inside the unit while cleaning.

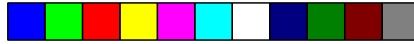

TROUBLESHOOTING GUIDE

Should this unit exhibit a problem, check the following before seeking service.

Symptom	Possible Cause	Solution
Radio		
Noise or sound distorted on AM or FM broadcasts.	Station not tuned properly for AM or FM.	Retune the AM or FM broadcast station.
	FM: Telescopic antenna is not extended.	Extend FM Telescopic antenna.
	AM: The bar antenna is not positioned correctly.	Reposition the unit until best reception is obtained.
FM STEREO indicator does not light.	The BAND selector is switched to FM position.	Switch the BAND selector to FM STEREO position.
AM or FM, no sound.	FUNCTION switch is not set to RADIO.	Set FUNCTION switch to RADIO.
	Volume at minimum.	Increase Volume.
Compact Disc Player		
CD Player will not play.	FUNCTION switch is not set to CD.	Set FUNCTION switch to CD.
	CD is not installed or installed incorrectly.	Insert CD with label side up.
CD skips while playing.	Disc is dirty or scratched.	Wipe disc with cloth or use another disc.



TO FIND THE LOCATION AND PHONE NUMBER OF YOUR NEAREST SERVICE CENTER PERMITTED TO PERFORM WARRANTY...

CALL TOLL FREE: 1-800-695-0098

FOR ADDITIONAL SET-UP OR OPERATING ASSISTANCE
PLEASE CALL:
1-800-898-9020

FOR CUSTOMER SERVICE, PLEASE WRITE TO:
Emerson Radio Corp.
Consumer Affairs Dept.
1901 Diplomat Drive,
Farmers Branch, TX 75234.

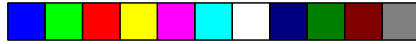

LIMITED WARRANTY

Emerson Radio Corp. warrants manufacturing defects in original material, including original parts and workmanship, under normal use and conditions, for a period of ninety (90) days from the date of original purchase in the U.S. With your dated proof of purchase, we will provide repair service at no charge for labor and parts at an authorized Depot Repair Facility, or replace the product in our discretion. For repair or replacement, pack your unit in a padded box, enclose your check or money order payable to Emerson Radio Corp. in the amount of \$9.00 (not required by California residents) to cover shipping and handling costs, and enclose a copy of your proof of purchase. Send your unit to:

Emerson Radio Corp.
1901 Diplomat Drive.
Farmers Branch, TX 75234.

This warranty does not cover damage from negligence, misuse, abuse, accident, failure to follow operating instructions, commercial use, rental, repairs by an unauthorized facility, or products purchased, used, serviced or damaged outside of the United States.

THIS WARRANTY GIVES YOU SPECIFIC LEGAL RIGHTS, AND YOU MAY ALSO HAVE OTHER RIGHTS WHICH VARY FROM STATE TO STATE.

AU898M



EMERSON RADIO CORP.



EMERSON
Part No.: 16-2887
301-01

Printed in China

