

Electric cooker

# INSTRUCTION BOOKLET

Please read this instruction booklet before using the appliance

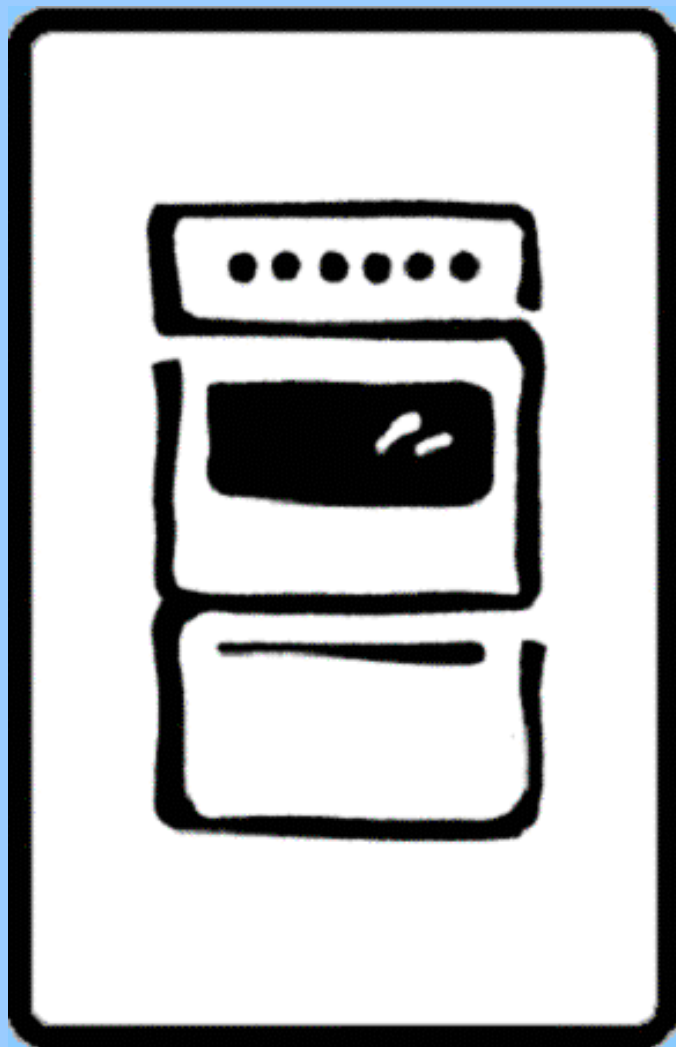

 **Electrolux Premier**

*DSO51EL*

 **Electrolux**



## WARNINGS

It is most important that this instruction book should be retained with the appliance for future reference. Should the appliance be sold or transferred, always ensure that the book is left with the appliance in order that the new owner can get to know the functions of the appliance and the relevant warnings.

These warnings are provided in the interest of safety. You **MUST** read them carefully before installing or using the appliance.

### Installation

- This cooker must be installed by qualified personnel, according to the manufacturer's instructions and to the relevant British Standards.
- This cooker is heavy. Take care when moving it.
- Remove all packaging before using the cooker.
- **Ensure that the electrical supply complies with the type stated on the rating plate.**
- Do not attempt to modify the cooker in any way.

### Child Safety

- This cooker is designed to be operated by adults. Do not allow children to play near or with the cooker.
- The cooker gets hot when it is in use and retain their heat for a long period after use. Children should be kept away until it has cooled.
- Children can also injure themselves by pulling pans or pots off the cooker.

### During use

- This cooker is intended for domestic cooking only. It is not designed for commercial or industrial purposes.
- Do not use this cooker if it is in contact with water. Do not operate the cooker with wet hands.
- **The grill pan will become hot during use, always use oven gloves when removing or replacing a hot grill pan.**
- **During use the appliance becomes hot. Care should be taken to avoid touching heating elements inside the oven.**
- Ensure the control knobs are in the 'OFF' position when not in use.
- When using other electrical appliances, ensure the cable does not come into contact with the hot surfaces of the cooker.
- Unstable or misshapen pans should not be used on the hob hotplates as unstable pans can cause an accident by tipping or spillage.

- Never leave the cooker unattended when cooking with oil and fats.
- This cooker should be kept clean at all times. A build-up of fats or foodstuffs could result in a fire.
- Only clean this oven in accordance with the instructions.
- Never use plastic dishes in the oven or on the hob hotplates. Never line any part of the oven with aluminium foil.
- Always ensure that the oven vent which is located at the centre back of the hob is left unobstructed to ensure ventilation of the oven cavity.
- Perishable food, plastic items and aerosols may be affected by heat and should not be stored above the cooker.

### Service

- This cooker should only be repaired or serviced by an authorised Service Engineer and only genuine approved spare parts should be used.



### Environmental Information

- After installation, please dispose of the packaging with due regard to safety and the environment.
- When disposing of an old appliance, make it unusable, by cutting off the cable.

**Your safety is of paramount importance.**  
**Therefore, if you are unsure about any of the meanings of these WARNINGS, contact the:**  
**Customer Care Department**  
**Telephone: 08705 950950**

# CONTENTS

## Instructions for the Installer

Technical features	5
Installation	6
Location	6
Electrical connections	7

## Instructions for the User

Use and care	8
Before the first use of the oven	9
Electric oven	10
- Oven function control knob	10
Cooking in the oven	10
Grilling	11
Hints and tips	11
Electric hotplates	12
Hints and tips	13
Maintenance and cleaning	15
Oven bulb replacement	16
Something Not Working	17
Service and spare parts	18
Guarantee Conditions	19

### How to read the instruction book

The symbols below will guide you when reading the instruction book



Safety instructions



Step by Step Operation



Advice and recommendations



Environmental Information

# INSTRUCTIONS FOR THE INSTALLER

## TECHNICAL FEATURES

Dimensions	Height		900 mm
	Width		500 mm
	Depth		600 mm
	Oven Capacity		49 l
Hob	Front left	Hob element Ø 180 mm	2000 - 2090 W
	Back left	Hob element Ø 145 mm	1000 - 1050 W
	Front right	Hob element Ø 145 mm	1000 - 1050 W
	Back right	Hob element Ø 180 mm	1500 - 1570 W
Total hob rating			5500 - 5760 W
Oven	Oven element		1650 - 1700 W
	Grill element		1825 - 1900 W
	Light in the oven	Lamp 25W type E14	
	Cleaning		manual
Total oven rating			1850 - 1925 W
Supply	Rated voltage		230 - 240 V
	Rated frequency		50 Hz
Accessories	Oven grid		
	Roasting tray / grill pan		
	Trivet		
	2 handles		
Total cooker rating			7350 - 7685 W

 This appliance complies with:  
 European Council Directive **73/23/EEC**  
 EMC Directive **89/336/EEC**  
 CE Marking Directive **93/68/EEC**

## INSTALLATION

 **This cooker must be installed in accordance with the IEE Wiring Regulations (Current Edition). Detailed recommendations are contained in the following British Standards Codes Of Practice: B.S. 6172/ B.S. 5440, Par.2 and B.S. 6891 Current Editions.**

The appliance must be installed in accordance with " X " specification (EN60.335-2.6). The cooker must not be installed higher than the worktop.

**Please ensure that when the appliance is installed it is easily accessible for the engineer in the event of a breakdown.**

Before your appliance is connected to the mains electricity supply, check to ensure that the voltage and the frequency shown on the rating plate corresponds with your supply voltage.

**This appliance must be earthed.**

## LOCATION

The cooker has been registered as a "Class X" appliance according to Fire Risk Regulations. Any adjacent cabinets or walls must not exceed the cooker's height.

The cooker may be located in a kitchen, a kitchen/diner or bed sitting room, but not in a bathroom, shower room or garage.

The minimum distance combustible material can be fitted above the cooker in line with the edges of the cooker is 660 mm (see fig.)

 **The appliance must be set on a heatproof floor. The adjustable feet must not be removed.**

### Levelling

The appliance is provided with adjustable small feet placed in the back and front corners of the base.

By adjusting the small feet it is possible to change the height of the appliance so as to ensure a better levelling with other surfaces and an even distribution of the liquids contained in pots and pans.

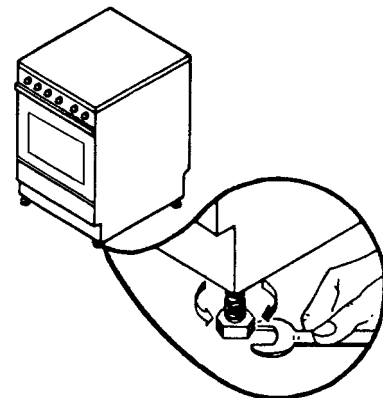
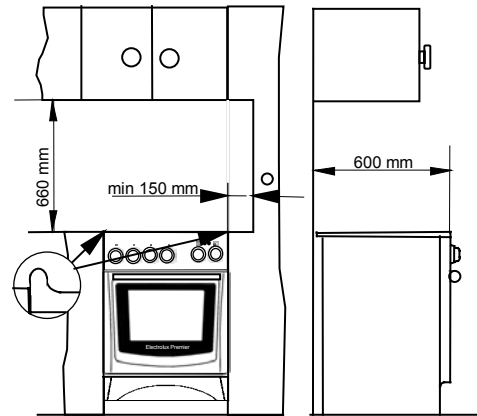

## ELECTRICAL CONNECTIONS

**⚠ Any electrical work required to install this hob and the supply cable should be carried out by a qualified electrician or competent person, in accordance with the current regulations.**

**⚠ THIS COOKER MUST BE EARTHED.**

**⚠ The manufacturer declines any liability should these safety measures not be observed.**

**⚠ Before any maintenance or cleaning can be carried out, you must DISCONNECT the cooker from the electricity supply.**

This cooker is designed to be connected to a 230-240V AC, 50Hz electrical supply. To connect to the electricity supply, use cable type H05 RR-F.

Before connection, make sure the electricity supply voltage is the same as that indicated on the rating plate.

The cooker is supplied without supply cable. A flexible supply cable must be fitted, in accordance with the specification given in the relevant table no. 1.

The electrical connection should be made using a double pole isolating switch (cooker control switch) with at least 3mm contact separation in all poles. The cable must have conductors of sufficiently high cross-sectional area to prevent overheating or deterioration.

The switch should be sited within 2m of the cooker and be easily accessible at all times.

The yellow-green grounding cable must not be interrupted by the switch.

**NOTE:** The earth wire should be about 2 cm longer than the live and neutral wires.

After installation and connecting, the cable must be placed so that it cannot at any point reach a temperature of more than 50°C above the ambient temperature.

**The manufacturer disclaims any responsibility should these safety instructions not be carried out.**

**⚠ If the supply cable is damaged, it must be replaced by the manufacturer or its service agent or a similarly qualified person in order to avoid a hazard.**

**Before connecting check that:**

- The fuse and household electrical installation can carry the absorbed current of the appliance (see rating plate);
- The cooker connection outlet or the cooker control switch is easily accessible when the appliance is installed.

**How to proceed?**

- Unscrew and remove the protective cover at the back of the appliance;
- Connect the power cable to the terminal block of the cooker according to the table no.1;
- Secure by means of cable clamp;
- Make sure that the connection to the terminal block is matching the supply system, see table no.1;
- Refit and screw the protective cover on the back of the appliance.

**Table no. 1**

Rated voltage	230 V 1N
Connection type	Single phase (UK)
Cable connection to the terminal block	<div style="text-align: center;"> </div>
Mains Voltage	230 V
Voltage of heating elements	230 V
Fuse capacity	32 A
Cable section	3 x 6 mm <sup>2</sup>

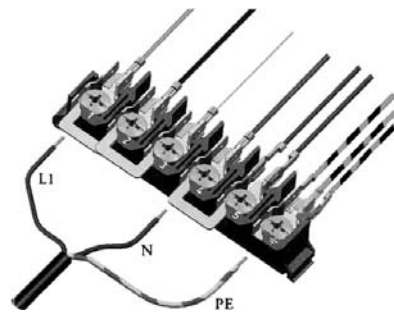

# INSTRUCTIONS FOR THE USER

## USE AND CARE

- A. Hob with electric plates
- B. Control panel
- C. Shelf supports
- D. Shelf
- E. Door handle
- F. Oven door
- G. Drawer
- H. Adjustable feet

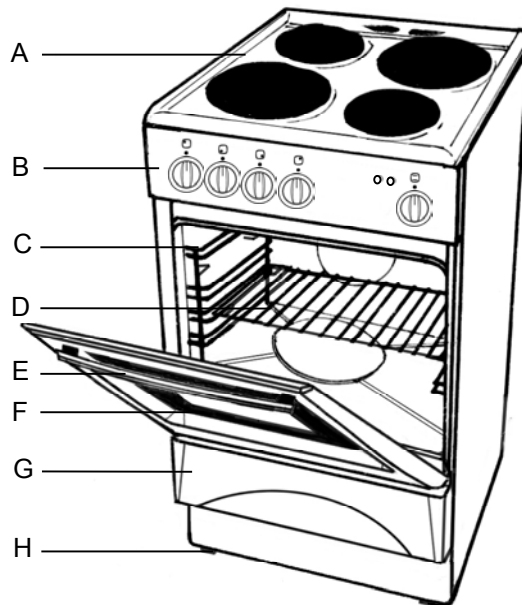

## CONTROL PANEL

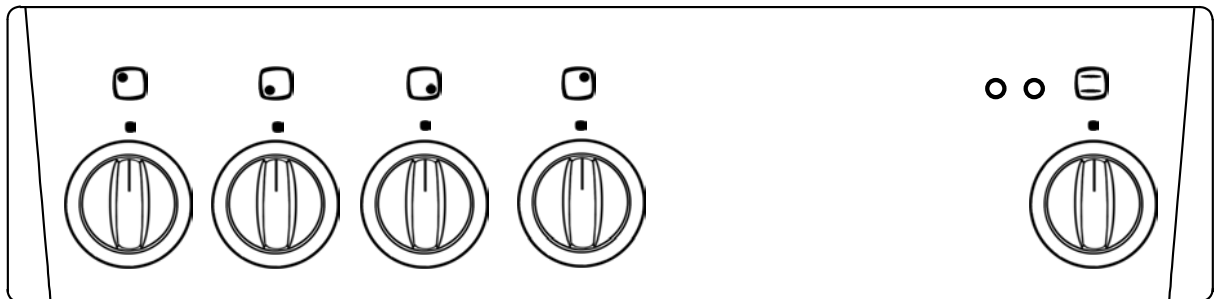



- 1. Back left hotplate control knob
- 2. Front left hotplate control knob
- 3. Front right hotplate control knob
- 4. Back right hotplate control knob
- 5. Mains pilot light
- 6. Oven thermostat pilot light
- 7. Oven function control knob (selector)



## USE OF APPLIANCE

### Before the First Use of the Oven

 **Before the first use ensure that the room is well ventilated: V.M.C. (Mechanic ventilation) or opened window.**

 **Remove all packaging, both inside and outside the oven, before using the oven.**

Before first use, the oven should be heated without food. During this time, an unpleasant odour may be emitted. This is quite normal.

1. Remove the oven accessories.
2. Remove any adhesive labels or protective films, if there are any.
3. Heat the oven at the maximum temperature for about 45 min.

This procedure should be repeated with the grill function for approximately 5-10 minutes.

Clean the accessories with a soft detergent. Rinse and dry carefully.

### Rating Plate

The model number of your cooker can be found on the rating plate on the lower front frame of the cooker upon opening the door.

The cooker must be protected by a suitably rated fuse or circuit breaker. The rating of the cooker is given on the rating plate.

### About condensation and steam

When food is heated it produces steam in the same way as a boiling kettle. The oven vents allow some of this steam to escape. However, **always stand back from the oven when opening the oven door** to allow any build up of steam or heat to release.

If the steam comes into contact with a cool surface on the outside of the oven, e.g. a trim, it will condense and produce water droplets. This is quite normal and is not a fault with the oven.

To prevent discolouration, regularly wipe away condensation and also soilage from surfaces.

### Cookware

Use any ovenproof cookware, which will withstand temperatures of 250°C.

**Oven dishes, etc. should not be placed directly on the oven base.**

 **During cooking in the oven the oven door is hot. Take care that children do not play near it.**

# ELECTRIC OVEN

## Oven Function Control Knob

The control knob is used to select the desired temperature and to select either the grill or oven function.

**0** Oven switched off

**50-250** Temperature selection (bottom and top heat)



**Grill** - The grill cannot be used at the same time as the oven. **The oven door must be closed when grilling.**

The grill temperature is not adjustable and always operates at maximum. For oven cooking use the control knob to select the desired temperature between 50° – 250°C.

The temperature will be kept constant by the thermostat.

### Caution

Do not place pans, dripping pans, baking trays or aluminium foil directly on the base of the oven. This could cause a heat build-up which could affect the performance of the oven and damage the oven enamel.

## Cooking in the oven

### Traditional cooking

Traditional cooking is made by natural convection the heated air.

**It is necessary to pre-heat the oven.**

### How to proceed ?

For small cakes, pastry, Victoria sandwich.

1. Preheat the oven the thermostat on position chosen for cooking:
  - about 8 min. for position 50°C to 150°C;
  - about 15 min for position 175°C to 250°C;
2. Insert the dish.

### Oven thermostat pilot light

Once the oven temperature has been selected, the oven thermostat pilot light will come on and remain on until the oven has reached the correct setting; after that, it will go on and off with the thermostat, showing that the temperature is being maintained.

### Cooker operation pilot light (Mains)

This light will illuminate when the oven function control knob or any of the hotplate knobs are turned on and remains lit while the these are in use.

### Oven light

The oven light will come on when the oven function control knob is set.

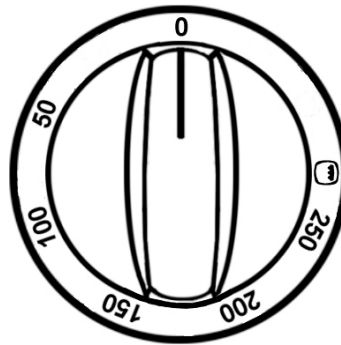

## Grilling



**When grilling, the accessible parts of the appliance are hot and the appliance should not be left unattended. Take care that children do not play near it. During use the appliance becomes hot. Care should be taken to avoid touching heating elements inside the oven.**



**The grill pan will become hot during use, always use oven gloves when removing or replacing a hot grill pan, or the grill pan handles if provided.**



**All grilling must be carried out with the oven door closed .**



To switch on the grill, turn the oven function control knob to GRILL.

Most foods should be placed on the grid in the grill pan to allow maximum circulation of air to lift the food out of the fats and juices. Food such as fish, liver and kidneys may be placed directly on the grill pan, if preferred.

Adjust the grid and grill pan runner position to allow for different thicknesses of food.

Food should be thoroughly dried before grilling to minimise splashing. Brush lean meats and fish lightly with a little oil or melted butter to keep them moist during cooking.

Accompaniments such as tomatoes and mushrooms may be placed underneath the grid when grilling meats.

When toasting bread, we suggest that the top runner position is used with the grid in its 'high' position.

Preheat the grill for a few minutes before sealing steaks or toasting. Adjust the shelf position as necessary, during cooking.

The food should be turned over during cooking, as required.

**NOTE: For safety in use, the grill element is controlled by the thermostat. During cooking, the grill cycles on and off to prevent overheating.**

Cooking time depends on the thickness of the meat and not on its weight.



## Hints and Tips

### Oven Cooking

- Turn off the oven 5 minutes before the end of cooking time, and use residual heat to complete the cooking.
  - The thickness, the material and the colour of the pan will influence the cooking results.
  - When cooking, certain dishes increase in volume, ensure the pan is large enough.
  - To prevent fat dripping when roasting use tall rim pans proportional to the item being roasted.
  - Prick the skin of poultry and sausages with a fork before cooking to avoid spitting.
- Use heatproof glass dishes for soufflés.

### The effects of dishes on cooking results

Dishes and tins vary in their thickness, conductivity, colour, etc. which affects the way they transmit heat to the food inside them.

- A** Aluminium, earthenware, oven glassware and bright shiny utensils reduce cooking and base browning.
- B** Enamelled cast iron, anodised aluminium, aluminium with non-stick interior and coloured exterior and dark, heavy utensils increase cooking and base browning.

## ELECTRIC HOTPLATES

To switch on a hotplate, turn the relevant control knob to the required heat setting.

The control knob is numbered 0 – 6

0 – OFF

1 – Minimum

6 – Maximum.

The hob has two types of hotplates:

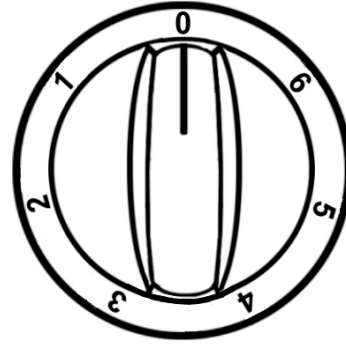

### Normal Hotplates

We recommend the plates are switched to maximum (6) for a short while to boost the plate, and then adjusted to the required setting.

### Rapid Hotplate (Front left)

The rapid hotplates indicated by a red spot, will heat up more quickly than a normal plate.

**i** Over a period of time the red spot may disappear, this will not affect the performance of the hotplate.

**i** It is important to note that the hotplate may smoke and produce a slightly unpleasant odour when used for the first time. This is quite normal and will disappear after some time.

**!** Do not put anything on the hob that is liable to melt.

Suggestions for the correct setting of the plates are given in the following table:

OFF	<b>0</b>	
Very Gentle	<b>1</b>	To keep food warm To melt butter and chocolate
Gentle	<b>2</b>	To prepare cream-sauces, stews and milk puddings or to fry eggs
Slow	<b>3</b>	Dried vegetables, frozen food, fruit, boiling water or milk
Medium	<b>4</b>	Boiled potatoes, fresh vegetables, pâtés, soups, broths, pancakes or fish
High	<b>5</b>	Larger stews, meat roll, fish, omelettes, steaks
Fast	<b>6</b>	Steaks, escalopes and frying

Saucepans for use on solid hotplates should have several characteristics:

- They should be fairly heavy duty.
- They should fit the heat area exactly, or be slightly larger for efficient use, NEVER smaller.
- They should have a flat base to ensure good contact with the hotplate. This is particularly important when using pans for high temperature frying pressure cooking.

As soon as liquid starts boiling, turn the hotplate control knob so that it will barely keep the liquid simmering.

You can switch off the hotplate a short while before you finish cooking, and the final stage will be completed using the accumulated heat.

 **Ensure pans are large enough to avoid liquids being spilled onto the plates. Never leave the plates on without a pan on them or with an empty pan on them.**

 **Take care never to lean or reach over a hot electric plate. Always point pan handles inward or over the work surface next to the hob to avoid accidentally knocking over a pan as you pass by.**

 **Take care when frying food in hot oil or fat, as the overheated splashes could easily ignite.**

 **If the control knobs become difficult to turn, please contact your local Service Force Centre.**

**Good use**



**Bad use**



## Accessories delivered with the appliance

The following accessories are supplied with your appliance.

- Shelf for placing dishes on .  
The dish should be put in the middle of the shelf to balance the weight.
- A roasting tray with roasting grid on it.  
It is used to collect juice when cooking in it, place it on the shelf 2.  
If you do not use the roasting tray, remove it from the oven.
- Removable handles

In addition to the accessories supplied we recommend you only use heatproof dishes/pans (according to the manufacturer's instructions).

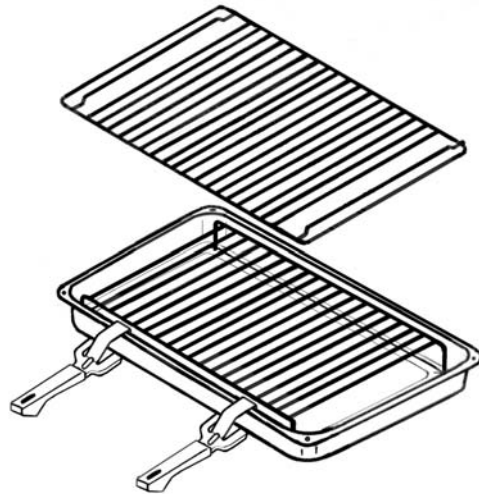

## Removable drawer

The removable drawer is located underneath the oven cavity.



**During cooking the drawer may become hot if the oven is in use for a long period of time. Flammable materials such as oven gloves, tea towels, plastic aprons etc. should not be stored in the drawer.**

Oven accessories such as baking sheets, will also become hot, therefore care should be taken when removing these items from the drawer whilst the oven is in use or still hot.



To open

- Grasp the drawer from underneath and pull it out as shown.
- To remove the drawer, pull it out to the stop, then lift it up slowly and pull it out completely.

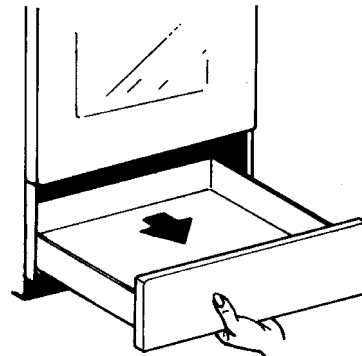
**To replace the drawer follow the same procedure in reverse.**



## MAINTENANCE AND CLEANING

-  **The oven should be kept clean at all times. A build-up of fats or other foodstuffs could result in a fire.**
-  **Before cleaning, ensure all control knobs are in the OFF position, and the appliance has cooled completely.**
-  **Before any maintenance or cleaning can be carried out, you must DISCONNECT the cooker from the electricity supply.**

### Cleaning materials

Before using any cleaning materials on your oven, check that they are suitable and that their use is recommended by the manufacturer.

-  **Cleaners that contain bleach should NOT be used as they may dull the surface finishes. A steam cleaner is not to be used. Harsh abrasives should also be avoided.**

### External cleaning

We recommend that non-abrasive cleaners are used; Avoid the use of metal objects, steel wool or nylon pads, abrasive or caustic products, as these may scratch the surface. Regularly wipe over the control panel, oven door and door seal using a soft cloth well wrung out in warm water to which a little washing up liquid has been added.

In the case of stainless steel parts, you may use commercially available stainless steel cleaners with care. These also provide a protective film against finger marks.

-  **To prevent damaging or weakening the door glass panels avoid the use of the following:**
  - **Household detergent and bleaches**
  - **Impregnated pads unsuitable for non stick saucepans**
  - **Brillo/Ajax pads or steel wool pads**
  - **Chemical oven pads or aerosols**
  - **Rust removers**
  - **Bath/Sink stain removers**

### Oven Cavity

The enamelled oven cavity is best cleaned whilst the oven is still warm.

Wipe the oven over with a soft cloth soaked in warm soapy water after each use. From time to time it will be necessary to do a more thorough cleaning, using a proprietary oven cleaner.

### Oven Shelves and shelf support

To clean the oven shelves, and shelf support soak in warm soapy water and remove stubborn marks with a well wetted soap impregnated pad. Rinse well and dry with a soft cloth.

### Cleaning the Oven door

For a more complete cleaning of the oven door, it is advisable to remove it in the following way:

- Open the door completely.
- Turn the two locking plates on the hinge arms to 170°;
- Partially close the door, to a 30° angle;
- Lift the door and pull out.

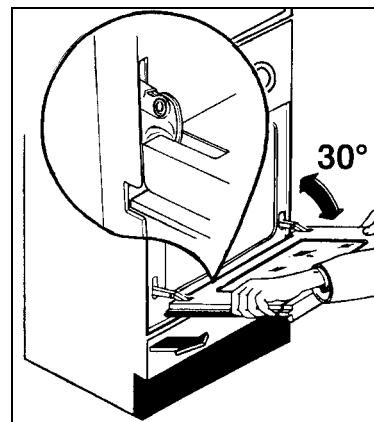
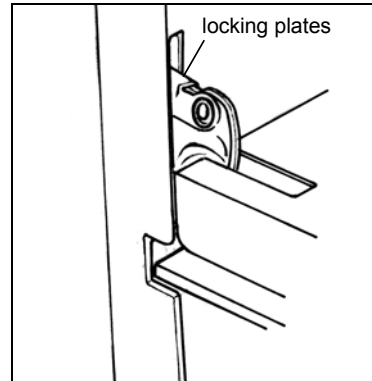

Refit the door by reversing the operation described above.

-  **DO NOT clean the oven door while the glass panels are warm. If this precaution is not observed the glass panel may shatter. If the door glass panel becomes chipped or has deep scratches, the glass will be weakened and must be replaced to prevent the possibility of the panel shattering. Contact your local Service Centre who will be pleased to advise further.**

## The Hob Top

The hob is best cleaned whilst it is still warm, as spillage can be removed more easily than if it is left to cool.

Regularly wipe over the hob top using a soft cloth well wrung out in warm water to which a little washing up liquid has been added. Avoid the use of the following:

- household detergent and bleaches;
- impregnated pads unsuitable for non-stick saucepans;
- steel wool pads;
- bath/sink stain removers.

## The Hotplates

Spills onto the actual plate should be removed using warm water and a soft brush, nylon or plastic scourer. To keep the plates looking as new, hotplate conditioner can be purchased from most hardware stores, e.g. "4 Hob" by HomeCare Products (follow the manufacturer's instruction for use). Alternatively, wipe the plates with a drop of olive oil on a kitchen towel to avoid rust. It is important to note that the plate will smoke a little and produce a slightly unpleasant odour when next used.

## Drying

**Important:** After cleaning, dry the hotplates thoroughly by switching on to a low-medium setting for a few minutes.

## Restoring

To maintain the appearance of your sealed hotplates apply a little salt-free vegetable oil or restorative agent periodically.

*To apply vegetable oil:* first heat the hotplate on a medium setting for 30 seconds then turn off. Pour a very small amount of salt-free oil onto a dry cloth or kitchen paper. Apply a thin coat of oil to the hotplate surface and wipe off any excess. Heat the hotplate on a medium setting for 1 minute.

*To apply restorative agent:* first heat the hotplate on a medium setting for 30 seconds then turn off. Apply a very thin coating of Collo Electrol (using the applicator). Heat a hotplate on a high setting for 2-3 minutes to cure. Some smoke will occur, this is normal and nontoxic. (NB: this product is a restorative agent not a cleanser. It is available from hardware stores).

*Stainless steel parts:* the stainless steel spill rings may become straw coloured with use. Use a proprietary stainless steel cleaner to remove this straw discolouration. This also applies to the area around the hotplates on stainless steel hobs.

## OVEN BULB REPLACEMENT



**Ensure that the appliance is switched off and disconnected from the electricity supply before replacing the bulb to avoid possibility of an electric shock.**

If the oven bulb needs replacing, it must comply with the following specifications:

Wattage:	25W
Voltage:	230/240V(50Hz)
Temperatures:	300°C
Thread Type:	E14



**To replace the faulty bulb.**

1. Turn the glass cover anticlockwise and remove.
2. Remove the faulty bulb and replace with a new one.
3. Refit the glass cover.

Reconnect the appliance to the electricity supply.

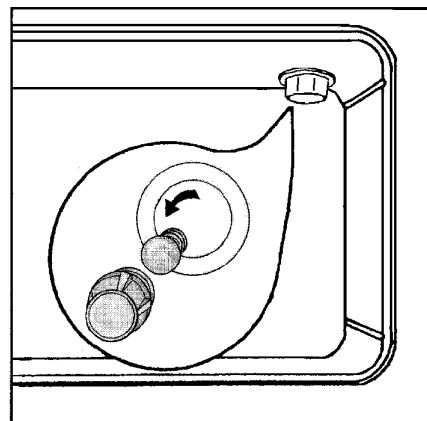



## SOMETHING NOT WORKING

If the appliance is not working correctly, please carry out the following checks, before contacting your local Service Force Centre.

**IMPORTANT: If you call out an engineer to a fault listed below, or to repair a fault caused by incorrect use or installation, a charge will be made even if the appliance is under guarantee.**

<b>Symptoms</b>	<b>Solutions</b>
<b>The hob hotplate does not heat up</b>	<b>Check:</b> <ul style="list-style-type: none"> <li>- that the unit is connected and the electrical supply is switched on</li> <li>- the mains fuse has not blown</li> <li>- the correct control knob has been turned.</li> </ul>
<b>The hotplate is not giving satisfactory results</b>	<b>Check:</b> <ul style="list-style-type: none"> <li>- the hotplate is clean and dry</li> <li>- the pan is the correct size for the hotplate</li> <li>- the pan has a flat base</li> <li>- the setting is correct for the type of cooking.</li> </ul>
<b>The oven does not come on</b>	<b>Check:</b> <ul style="list-style-type: none"> <li>- check if a cooking function/temperature has been selected correctly</li> <li>- the socket switch or the switch from the mains supply to the cooker are ON.</li> </ul>
<b>It takes too long to finish the dishes, or they are cooked too fast</b>	<b>Check:</b> <ul style="list-style-type: none"> <li>- the temperature may need adjusting</li> </ul>
<b>Steam and condensation settle on the food and the oven cavity</b>	<ul style="list-style-type: none"> <li>- refer to the contents of this booklet, especially to the chapter "Using the Oven".</li> <li>- Leave dishes inside the oven no longer than 15-20 minutes after the cooking is completed.</li> </ul>

If after these checks, the appliance still does not operate correctly, contact your local Service Force Centre. When you contact the Service Force Centre you will need to give the following details:

1. Your name, address and post code.
2. Your telephone number
3. Clear and concise details of the fault
4. The model and serial number of the appliance (found on the rating plate\*)
5. The purchase date

\* The rating plate can be found on the lower left hand corner of the front frame of the cavity.

**Please note that a valid purchase receipt or guarantee documentation is required for in-guarantee service calls.**

## SERVICE AND SPARE PARTS



In the event of your appliance requiring service, or if you wish to purchase spare parts, please contact your local Service Force Centre by telephoning:-

**08705 929929**

Your telephone call will be automatically routed to the Service Force Centre covering your post code area.

For the address of your local Service Force Centre and further information about Service Force, please visit the website at [www.serviceforce.co.uk](http://www.serviceforce.co.uk)

**In-guarantee customers should ensure that the checks under the heading “Something Not Working” have been made as the engineer will make a charge if the fault is not a mechanical or electrical breakdown. Please note that it will be necessary to provide proof of purchase for any in-guarantee service calls.**

## CUSTOMER CARE

For general enquiries concerning your Electrolux appliance and or for further information on our products, contact our Customer Care Department by letter or telephone as follows or visit our website at [www.electrolux.co.uk](http://www.electrolux.co.uk)

Customer Care Department  
Electrolux  
55-77 High Street  
Slough  
Berkshire SL1 1DZ

Tel: 08705 950950 (\*)

(\*) calls to this number may be recorded for training purposes.

## GUARANTEE CONDITIONS

### Standard Guarantee Conditions

We Electrolux undertake that if, within 12 months of the date of the purchase, this Electrolux appliance or any part thereof is proved to be defective by any reason only of faulty workmanship or materials, we will, at our option, repair or replace the same FREE OF ANY CHARGE for labour, materials or carriage on condition that:

- The appliance has been correctly installed and used only on the electricity supply stated on the rating plate.
- The appliance has been used for normal domestic purposes only, and in accordance with the manufacturer's instructions.
- The appliance has not been serviced maintained, repaired, taken apart or tampered with by any person not authorised by us.
- All service work under this guarantee must be undertaken by an Electrolux Service Force Centre.
- Any appliance or defective part replaced shall become the Company's property.
- This guarantee is in addition to your statutory and other legal rights.

Home visits are made between **8.30am and 5.30pm** Monday to Friday. Visits may be available outside these hours, in which case a **premium** will be charged.

### Exclusions

This guarantee does not cover:

- Damage or calls resulting from transportation, improper use or neglect, the replacement of any light bulbs or removable parts of glass or plastic.
- Costs incurred for calls to put right an appliance which is improperly installed or calls to appliance outside the United Kingdom.
- Appliances found to be in use within a commercial or similar environment, plus those, which are the subject to rental agreements.  
Products of Electrolux manufacture which are not marketed by Electrolux.

### European Guarantee

If you should move to another country within Europe then your guarantee moves with you to your new home subject to the following qualifications:

- The guarantee starts from the date you first purchased your product.
- The guarantee is for the same period and to the same extent for labour and parts as exist in the new country of use for this brand or range of products.
- This guarantee relates to you and cannot be transferred to another user.
- Your new home is within the European Community (EC) or European Free Trade Area.
- The product is installed and used in accordance with our instructions and is only used domestically, i.e. a normal household
- The electrical supply complies with the specification given in the rating label.
- The product is installed taking into account regulations in your new country.

Before you move, please contact your nearest Customer Care Centre, listed below, to give them details of your new home. They will then ensure that the local Service Organisation is aware of your move and able to look after you and your appliances.

France	Senlis	+33 (0) 3 44 62 20 13
Germany	Nürnberg	+49 (0) 800 234 7378
Italy	Pordenone	+39 (0) 800117511
Sweden	Stockholm	+46 (0) 20 78 77 50
UK	Slough	+44 (0) 1753 219898

**Customer Care Department**

**Electrolux**  
55-77 High Street  
Slough  
Berkshire SL1 1DZ

Tel: 08705 950 950



© Electrolux plc 2003

 **The Electrolux Group.** *The world's No.1 choice*

*The Electrolux Group is the world's largest producer of powered appliances for kitchen, cleaning and outdoor use. More than 55 million Electrolux Group products (such as refrigerators, washing machines, vacuum cleaners, chain saws and lawn mowers) are sold each year to a value of approx.USD 14 billion in more than 150 countries around the world.*