

76331 KF-N

User manual

Ceramic glass hob

Dear Customer

Thank you for choosing one of our high-quality products.

With this appliance you will experience the perfect combination of functional design and cutting edge technology.

Convince yourself that our appliances are engineered to deliver the best performance and control - indeed we are setting the highest standards of excellence.

In addition to this you find environmental and energy saving aspects as an integral part of our products.

To ensure optimal and regular performance of your appliance please read this instruction manual carefully. It will enable you to navigate all processes perfectly and most efficiently.

To refer to this manual any time you need to, we recommend you to keep it in a safe place. And please pass it to any future owner of the appliance.

We wish you much joy with your new appliance.

The following symbols are used in this user information:



Warning! This must be read! Important advice for the safety of persons and information on avoiding damage to the appliance



General information and advice



Information on environmental protection



Dangerous voltage

Contents

Operating Instructions	4
Safety instructions	4
Description of the Appliance	6
Cooking surface layout	6
Control panel layout	6
Touch Control sensor fields	7
Displays	8
Residual heat indicator	8
Operating the appliance	9
Switching the appliance on and off	9
Setting the heat setting	9
Switching the outside ring on and off	10
Locking/unlocking the control panel	11
Switching the STOP+GO function on and off	11
Using the automatic warm-up function	12
Using the child safety device	13
Using the timer	14
Automatic switch off	17
Tips on Cooking and Frying	18
Cookware	18
Energy saving	18
Examples of cooking applications	19
Cleaning and Care	20
What to do if ...	21
Disposal	22
Installation Instructions	23
Safety instructions	23
Assembly	25
Rating Plate	28
Guarantee/Customer Service	29
Service	31

Operating Instructions



Safety instructions

Please comply with these instructions. If you do not, any damage resulting is not covered by the warranty.

Correct use

- This appliance is not intended for use by children or other persons whose physical, sensory or mental capabilities or lack of experience and knowledge prevents them from using the appliance safely without supervision or instruction by a responsible person to ensure that they can use the appliance safely.
- Do not leave the appliance unattended during operation.
- This appliance should be used only for normal domestic cooking and frying of food.
- The appliance must not be used as a work surface or as a storage surface.
- Additions or modifications to the appliance are not permitted.
- Do not place or store flammable liquids, highly inflammable materials or fusible objects (e.g. plastic film, plastic, aluminium) on or near the appliance.

Children's safety

- Small children must be kept away from the appliance.
- Only let bigger children work on the appliance under supervision.
- To avoid small children and pets unintentionally switching the appliance on, we recommend activation of the child safety device.

General safety

- The appliance may only be installed and connected by trained, registered service engineers.
- Built-in appliances may only be used after they have built in to suitable built-in units and work surfaces that meet standards.
- In the event of faults with the appliance or damage to the glass ceramic (cracks, scratches or splits), the appliance must be switched off and disconnected from the electrical supply, to prevent the possibility of an electric shock.
- Repairs to the appliance must only be carried out by trained registered service engineers.

Safety during use

- Overheated fats and oils can ignite very quickly. Warning! Fire hazard!
- There is the risk of burns from the appliance if used carelessly.
- Remove stickers and film from the glass ceramic.
- Cables from electrical appliances must not touch the hot surface of the appliance or hot cookware.
- Switch the cooking zones off after each use.

Safety when cleaning

- For cleaning, the appliance must be switched off and cooled down.
- For safety reasons, the cleaning of the appliance with steam jet or high-pressure cleaning equipment is not permitted.

How to avoid damage to the appliance

- The glass ceramic can be damaged by objects falling onto it.
- The edge of the glass ceramic can be damaged by being knocked by the cookware.
- Cookware made of cast iron, cast aluminium or with damaged bottoms can scratch the glass ceramic if pushed across the surface.
- Objects that melt and things that boil over can burn onto the glass ceramic and should be removed straightaway.
- To avoid damaging cookware and glass ceramics, do not allow saucepans or frying pans to boil dry.
- Do not use the cooking zones with empty cookware or without cookware.

Description of the Appliance

Cooking surface layout

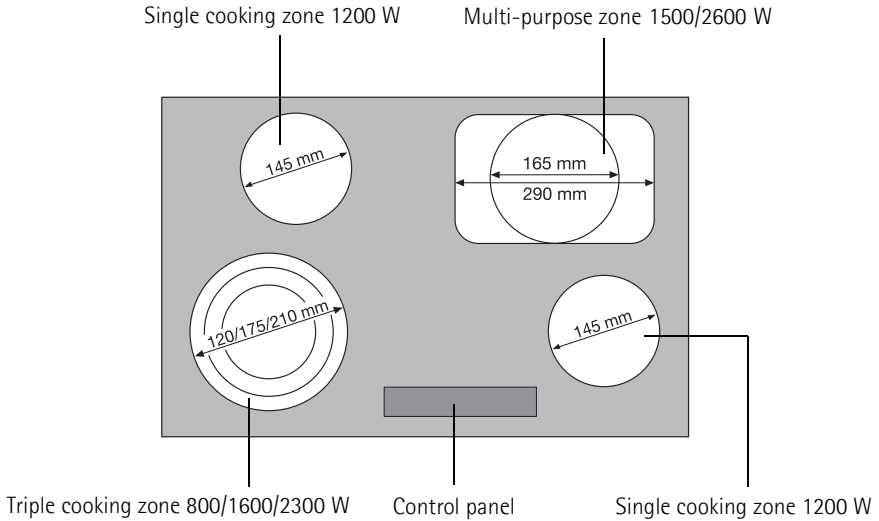

Control panel layout

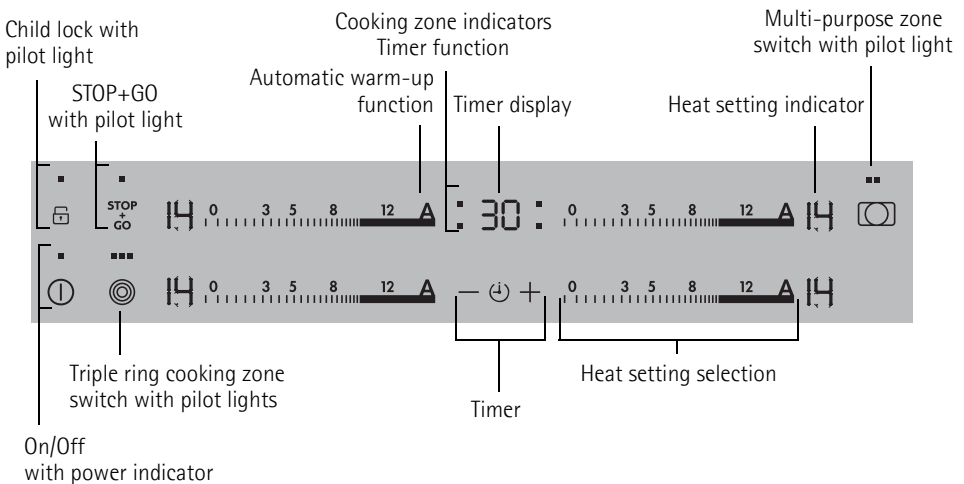

Touch Control sensor fields

The appliance is operated using Touch Control sensor fields. Functions are controlled by touching sensor fields and confirmed by displays and acoustic signals. Touch the sensor fields from above, without covering other sensor fields.

Sensor field		Function
ⓘ	On / Off	To switch the appliance on and off
🔒	Child lock	Locking control panel for children
STOP GO	Stop+Go	To switch the Keep Warm setting on/off
◎	Triple ring switch	To switch outer rings on and off
TIMER ⌚	Timer	Timer selection
+	Increase settings	To increase Timer time
-	Reduce settings	To reduce Timer time
◻	Multi-purpose zone switch	To switch the outside ring on and off
A	Automatic warm-up function	To switch automatic warm-up function on/off

Control bar

The control bar is a special Touch Control field.





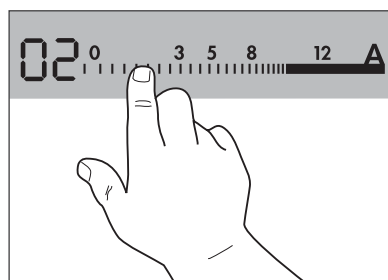





The control bar is touched where the desired heat setting is positioned. The heat setting is shown in the display. Correct to the left or the right, if necessary.

Do not release before the desired heat setting is reached.



If the control bar is touched for longer than 6 seconds, a signal sounds and the appliance switches itself off.

Displays

Display	Description
	Cooking zone is switched off
 / 	Keep Warm setting STOP+GO function / Keep Warm setting is set
 - 	Heat settings Heat setting is set
	Automatic warm up function Automatic warm-up function is activated
	Fault Malfunction has occurred
	Residual heat Cooking zone is still hot
	Child safety device Child safety device is engaged
	Automatic switch off Switch off is active.

Residual heat indicator



Warning! Risk of burns from residual heat. After being switched off, the cooking zones need some time to cool down. Look at the residual heat indicator .



Residual heat can be used for melting and keeping food warm.

Operating the appliance

Switching the appliance on and off

	Control panel	Display	Pilot light
Switch on	Touch ⓘ for 1 second	0 / H	lights up
Switch off	Touch ⓘ for 1 second	H / none	goes out

i After switching on, within approx. 10 seconds a heat setting or a function must be set, otherwise the appliance automatically switches itself off.

Setting the heat setting





	Control bar	Display
To set the heat setting	Touch the desired heat setting, if necessary, correct to the left or the right	1 to 14 / A
To switch off	Touch 0	0



Switching the outside ring on and off

By switching the outside rings on or off, the effective heating surface can be matched to the size of the cookware.





Before an outside ring can be switched on, the inside ring must be switched on.

Triple ring cooking zone	Sensor field	Pilot light
To switch on the central ring	Touch  1-2 seconds	Second pilot light lights up
To switch on the outer ring	Touch  for 1-2 seconds	Third pilot light lights up
To switch off the outer ring	Touch  for 1-2 seconds	Third pilot light goes out
To switch off the central ring	Touch  for 1-2 seconds	Second pilot light goes out

Multi-purpose zone	Sensor field	Pilot light
To switch on the outer ring	Touch  1-2 seconds	Second pilot light lights up
To switch off the outer ring	Touch  for 1-2 seconds	Second pilot light goes out

Locking/unlocking the control panel



The control panel, with the exception of the "On/Off" sensor field, can be locked at any time in order to prevent the settings being changed e.g. by wiping over the panel with a cloth.

	Control panel	Display
Switch on	Touch 	 (for 4 seconds)
Switch off	Touch 	previously set heat setting

 When you switch the appliance off, the locking function is automatically switched off.

Switching the STOP+GO function on and off

The STOP+GO function simultaneously switches all cooking zones that are switched on to the keep warm setting and then back to the heat setting that was previously set.

	Control panel	Display
To switch on	Touch 	
To switch off	Touch 	heat setting that was previously set (not automatic warm up function)

 Timer functions are not stopped by STOP+GO.

 STOP+GO locks the whole control panel except the sensor field .

Using the automatic warm-up function

All cooking zones are equipped with an automatic warm-up function. When setting a heat setting using the automatic warm-up function, the cooking zone switches to full power for a certain amount of time and then automatically switches back to the heat setting set.

Step	Control panel	Display
1.	Touch A	A
2.	Move your finger down from A to select the desired heat setting between 1 and 13	13 / 1 , after 5 seconds A . As long as A is displayed, the appliance works at full power. After the automatic warm up is completed, the heat setting 13 / 1 is displayed again.



The length of time that the automatic warm up function operates depends on the heat setting selected.

Heat setting	Length of the automatic warm up [min:sec]
1	1:00
2	1:40
3	2:40
4	4:50
5	5:30
6	6:30
7	8:10
8	10:10
9	12:20
10	2:30
11	2:30
12	3:30
13	4:30
14	---

Using the child safety device



The child safety device prevents unintentional use of the appliance.

Switching on the child safety device

Step	Control panel	Display/Signal
1.	① Switch on appliance. (Do not set a heat setting.)	
2.	Touch  for 4 seconds	

The child safety device is switched on.

Switching off the child safety device

Step	Control panel	Display/Signal
1.	① Switch on appliance. (Do not set a heat setting.)	
2.	Touch  for 4 seconds	 lights up
3.	① Switch appliance off.	



The child safety device is switched off.



The child safety device can only be switched on and off, if no heat setting is set.

Overriding the child safety device

The child safety device can be switched off in this way for a single cooking session; it remains activated afterwards.

Step	Control panel	Display/Signal
1.	① Switch appliance on	
2.	Touch  for 4 seconds	 lights up



Until the appliance is next switched off, it can be used as normal. After switching off the appliance, the child safety device is active again.











After overriding the child safety device, a heat setting or a function must be set within approx. 10 seconds, otherwise the appliance automatically switches itself off.

Using the timer

Function	Condition	Outcome after the time has elapsed
Automatic cut-out	a heat setting is set	acoustic signal 00 flashes Cooking zone switches off
Countdown timer	cooking zones not in use	acoustic signal 00 flashes

-  If just one countdown value is set you can change it only when the appliance is switched on.
-  If a heat setting is set on this cooking zone in addition to a countdown timer, the cooking zone is switched off after the time set has elapsed.
-  If a cooking zone is switched off, the timer function set is also switched off.

Selecting a cooking zone

Step	Control panel	Display
1.	Touch  TIMER once	Pilot light of the first cooking zone flashes 
2.	Touch  TIMER once	Pilot light of the second cooking zone flashes 
3.	Touch  TIMER once	Pilot light of the third cooking zone flashes 
4.	Touch  TIMER once	Pilot light of the fourth cooking zone flashes 

-  If other timer functions are set, after a few seconds the shortest remaining time of all the timer functions is displayed and the corresponding pilot light flashes.

Setting the time

Step	Control panel	Indicator
1.	Select  TIMER cooking zone	Pilot light for the cooking zone selected flashes
2.	Touch + or -	00 to 99 minutes

After a few seconds the pilot light flashes more slowly.
The time is set.
The time counts down.

Switching off the timer function

Step	Control panel	Indicator
1.	Select  TIMER cooking zone	Pilot light of cooking zone selected flashes faster Time remaining is displayed
2.	Touch -	The time remaining counts backwards to 00 .

The pilot light goes out.
The Timer function for the selected cooking zone is switched off.

Changing the time

Step	Control panel	Indicator
1.	Select  TIMER cooking zone	Pilot light of the selected cooking zone flashes faster Time remaining is displayed
2.	Touch + or -	01 to 99 minutes

After a few seconds, the pilot light flashes more slowly.
The time is set.
The time counts down.

Displaying the time remaining for a cooking zone

Step	Control panel field	Display
1.	 TIMER Select cooking zone	Pilot light of the cooking zone selected flashes faster The time remaining is displayed
After a few seconds the pilot light flashes more slowly.		

Switching off the acoustic signal

Step	Control panel field	Acoustic signal
1.	Touch  TIMER	Acoustic signal to acknowledge.
Acoustic signal stops.		

Automatic switch off



Cooking surface

- If after switching on the cooking surface, a heat setting is not set for a cooking zone within approx. 10 seconds, the cooking surface automatically switches itself off.
- If one or more sensor fields are covered by objects (a pan, cloths, etc.) for longer than approx. 10 seconds, a signal sounds and the cooking surface switches off automatically.
- If all cooking zones are switched off, the cooking surface automatically switches itself off after approx. 10 seconds.

Control panel

- When the appliance is switched off, if one or more of the sensor fields on the control panel are covered for more that 10 seconds, an acoustic signal sounds. The acoustic signal switches itself off automatically when the sensor fields are no longer covered.

Cooking zones

- If one of the cooking zones is not switched off after a certain time, or if the heat setting is not modified, the relevant cooking zone switches off automatically.  is displayed. Before being used again, the cooking zone must be set to .

Heat setting	Switches off after
1 - 3	6 hours
4 - 7	5 hours
8 - 9	4 hours
10 - 14	1.5 hours

Tips on Cooking and Frying



i Information on acrylamides

According to the latest scientific knowledge, intensive browning of food, especially in products containing starch, can constitute a health risk due to acrylamides. Therefore we recommend cooking at the lowest possible temperatures and not browning foods too much.



Cookware

- You can recognise good cookware from the bottoms of the pans. The bottom should be as thick and flat as possible.
- Cookware made of enamelled steel or with aluminium or copper bottoms can leave discolorations on the glass ceramic surface which are difficult or impossible to remove.

Energy saving

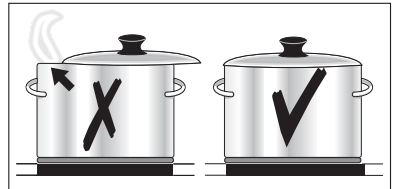
-  Always place cookware on the cooking zone before it is switched on.
-  If possible, always place lids on the pans.



-  Switch cooking zones off before the end of the cooking time, to take advantage of residual heat.
-  Bottom of pans and cooking zones should be the same size.

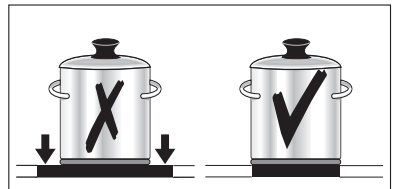

Examples of cooking applications

The information given in the following table is for guidance only.

Heat setting	Cooking-process	suitable for	Cooking time	Tips/Hints
0		Residual heat, Off position		
1	Keeping food warm	Keeping cooked foods warm	as required	Cover
1-3	Melting	Hollandaise sauce, melting butter, chocolate, gelatine	5-25 mins.	Stir occasionally
	Solidifying	Fluffy omelettes, baked eggs	10-40 mins.	Cook with lid on
3-5	Simmering on low heat	Simmering rice and milk-based dishes Heating up ready-cooked meals	25-50 mins.	Add at least twice as much liquid as rice, stir milk dishes part way through cooking
5-7	Steaming Braising	Steaming vegetables, fish braising meat	20-45 mins.	With vegetables add only a little liquid (a few table-spoons)
7-9	Boiling	Steaming potatoes	20-60 mins.	Use only a little liquid, e. g.: max. 1/4 l water for 750 g potatoes
		Cooking larger quantities of food, stews and soups	60-150 mins.	Up to 3 l liquid plus ingredients
9-12	Gentle Frying	Frying escalopes, veal cordon bleu, cutlets, rissoles, sausages, liver, roux, eggs, pancakes, doughnuts	Steady frying	Turn halfway through cooking
12-13	Heavy Frying	Hash browns, loin steaks, steaks, Flädle (pancakes for garnishing soup)	5-15 mins. per pan	Turn halfway through cooking
14	Boiling Searing Deep frying	Boiling large quantities of water, cooking pasta, searing meat (goulash, pot roast), deep frying chips		

Cleaning and Care



Take care! Risk of burns from residual heat.



Warning! Sharp objects and abrasive cleaning materials will damage the appliance. Clean with water and washing up liquid.



Warning! Residues from cleaning agents will damage the appliance. Remove residues with water and washing up liquid.

Cleaning the appliance after each use

1. Wipe the appliance with a damp cloth and a little washing up liquid.
2. Rub the appliance dry using a clean cloth.

Removing deposits

1. Place a scraper on the glass ceramic surface at an angle.
2. Remove residues by sliding the blade over the surface.
3. Wipe the appliance with a damp cloth and a little washing up liquid.
4. Rub the appliance dry using a clean cloth.

Type of dirt	Remove		
	immediately	when the appliance has cooled down	using
sugar, food containing sugar	yes	---	a scraper*
plastics, tin foil	yes	---	
limescale and water rings	---	yes	cleaner for glass ceramic or stainless steel*
fat splashes	---	yes	
shiny metallic discolouration	---	yes	

*Scrapers and cleaners for glass ceramic and stainless steel can be purchased in specialized shops







Remove stubborn residues with a cleaner for glass ceramic or stainless steel.



Scratches or dark stains on the glass ceramic that cannot be removed do not however affect the functioning of the appliance.

What to do if ...

Problem	Possible cause	Remedy
The cooking zones will not switch on or are not functioning	More than 10 seconds have passed since the appliance was switched on	Switch the appliance on again.
	The child safety device is switched on 	Deactivate the child safety device (See the section "Child safety device")
	Several sensor fields were touched at the same time	Only touch one sensor field
	Automatic switch off has been triggered	Remove any objects (pan, cloths, etc.) that are lying on the control panel. Switch the appliance on again
	There is water on the control panel or the control panel is covered with fat splashes	Wipe the control panel
	STOP+GO is activated 	Switching off STOP+GO
Acoustic signal sounds when appliance is switched off	The control panel is wholly or partly covered by objects.	Remove objects.
The residual heat indicator is not displaying anything	The cooking zone was only on for a short time and is therefore not hot	If the cooking zone is supposed to be hot, call the Customer Service Department.
Acoustic signal sounds and appliance switches itself on and then off again; after 5 seconds another acoustic signal sounds	The On/Off sensor field has been covered up, e.g. by a cloth	Do not place any objects on the control panel
 lights up	Automatic switch-off has been triggered	Switch appliance off. Switch appliance on again
 and number are displayed	Electronics fault	Disconnect the appliance from the electrical supply for a few minutes (Take the fuse out of the house's wiring system) If after switching on again,  is displayed again, call the customer service department

If you are unable to remedy the problem by following the above suggestions, please contact your local Service Force Centre.



Warning! Repairs to the appliance are only to be carried out by qualified service engineers. Considerable danger to the user may result from improper repairs.



If the appliance has been operated incorrectly, the engineer's visit will be chargeable, even during the warranty period.

Disposal



Packaging material

The packaging materials are environmentally friendly and can be recycled. The plastic components are identified by markings, e.g. >PE<, >PS<, etc. Please dispose of the packaging materials in the appropriate container at the community waste disposal facilities.



Old appliance

The symbol  on the product or on its packaging indicates that this product may not be treated as household waste. Instead it shall be handed over to the applicable collection point for the recycling of electrical and electronic equipment. By ensuring this product is disposed of correctly, you will help prevent potential negative consequences for the environment and human health, which could otherwise be caused by inappropriate waste handling of this product. For more detailed information about recycling of this product, please contact your local city office, your household waste disposal service or the shop where you purchased the product.

Installation Instructions



Safety instructions

Warning! This must be read!

The laws, ordinances, directives and standards in force in the country of use are to be followed (safety regulations, proper recycling in accordance with the regulations, etc.)

Installation may only be carried out by a qualified electrician.

The minimum distances to other appliances and units are to be observed.

Anti-shock protection must be provided by the installation, for example drawers may only be installed with a protective floor directly underneath the appliance.

The cut surfaces of the worktop are to be protected against moisture using a suitable sealant.

The sealant seals the appliance to the work top with no gap.

Avoid installing the appliance next to doors and under windows. Otherwise hot cookware may be knocked off the rings when doors and windows are opened.



Risk of injury from electrical current.

- The electrical mains terminal is live.
- Make electrical mains terminal free of voltage.
- Follow connection schematic.
- Observe electrical safety rules.
- Ensure anti-shock protection by installing correctly.
- The appliance must be connected to the electrical supply by a qualified electrician.



Risk of injury from electrical current.

- Loose and inappropriate plug and socket connections can make the terminal overheat.
- Have the clamping connections correctly installed by a qualified electrician.
- Use strain relief clamp on cable.
- In the event of single-phase or two-phase connection, the appropriate mains cable of type H05BB-F Tmax 90°C (or higher) must be used.
- If this appliance's mains cable is damaged, it must be replaced by a special cable (type H05BB-F Tmax 90°C; or higher). The latter is available from the Customer Care Department.

A device must be provided in the electrical installation which allows the appliance to be disconnected from the mains at all poles with a contact opening width of at least 3 mm.

Suitable isolation devices include line protecting cut-outs, fuses (screw type fuses are to be removed from the holder), earth leakage trips and contactors.

Sticking on the seal

- Clean the worktop around the cut-out area.
- Stick the single-sided adhesive sealing tape provided on the underside of the hob around the outside edge ensuring that it is not stretched. The two ends of the tape should join in the middle of one side. After trimming the tape (allow it to overlap by 2-3 mm), press the two ends together.



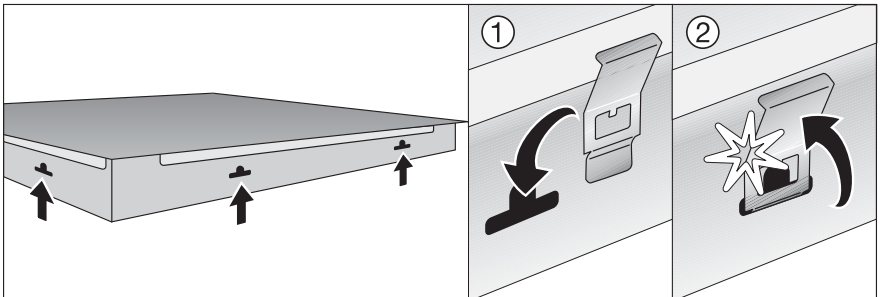
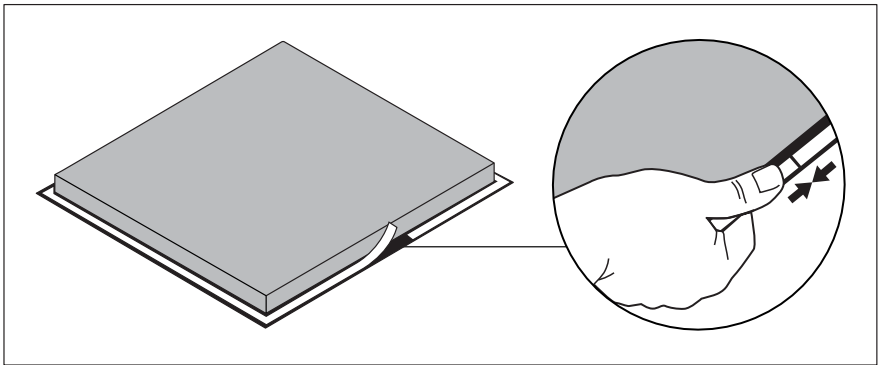
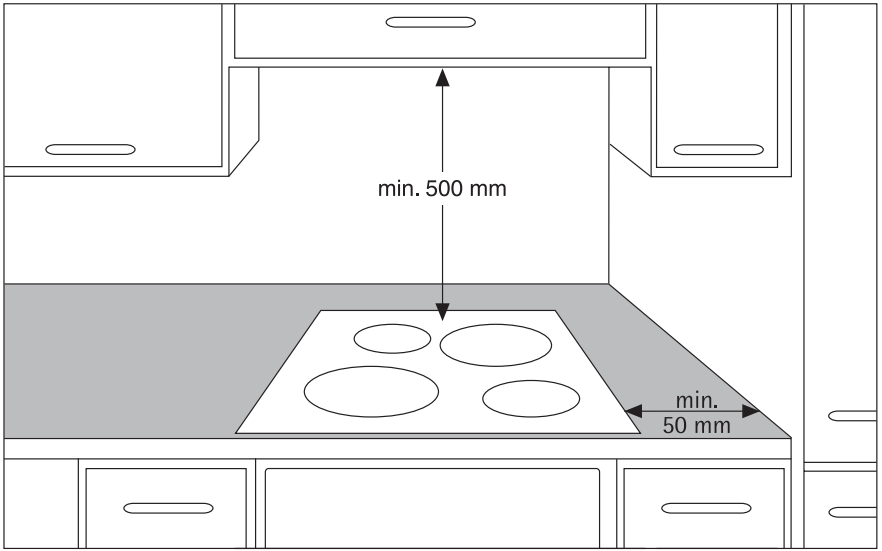

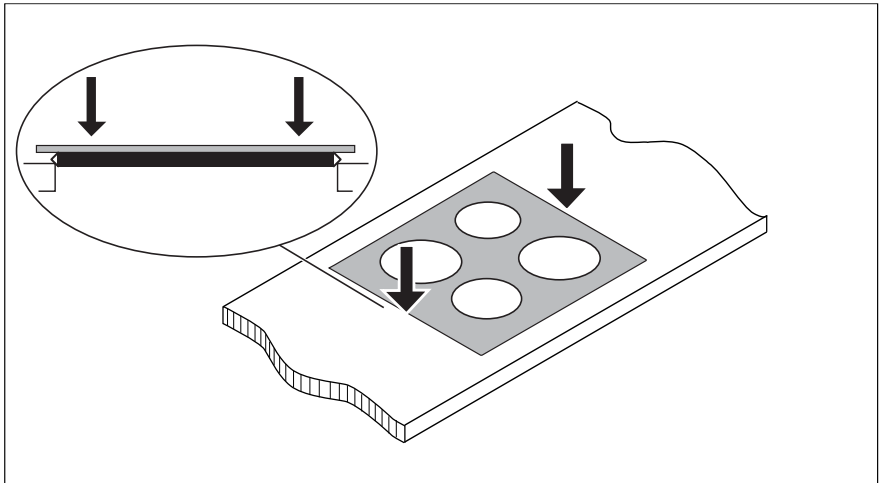
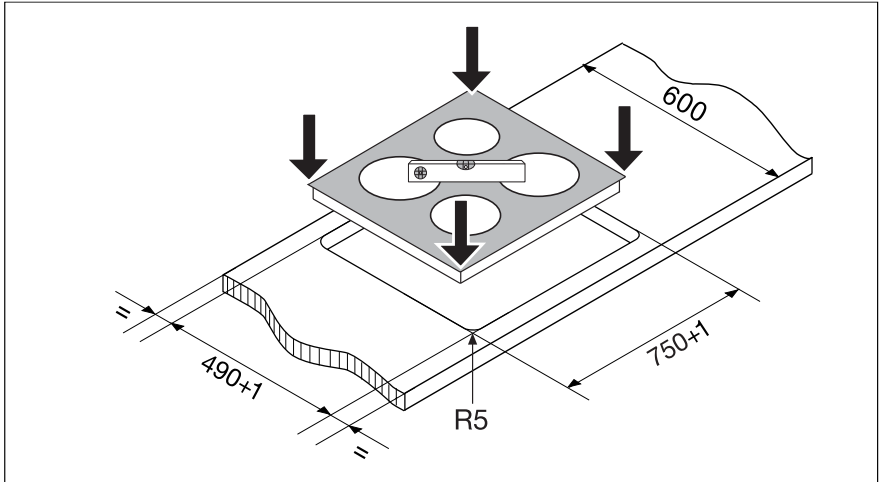
Assembly

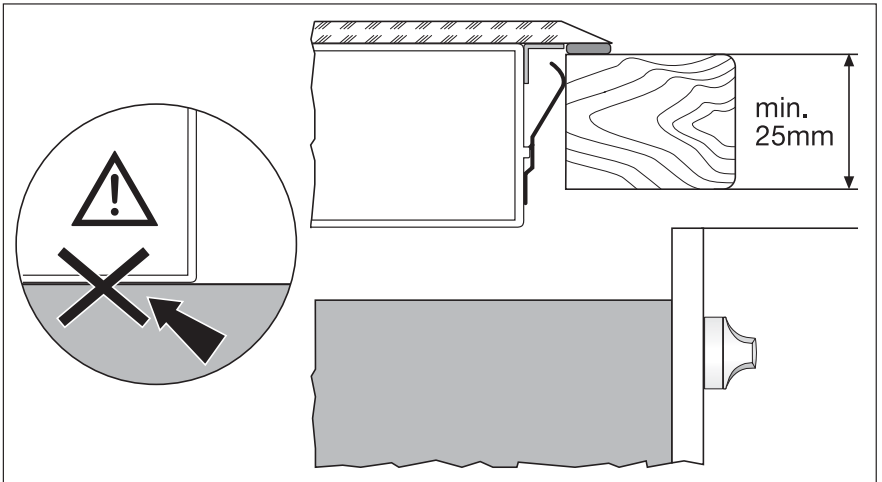
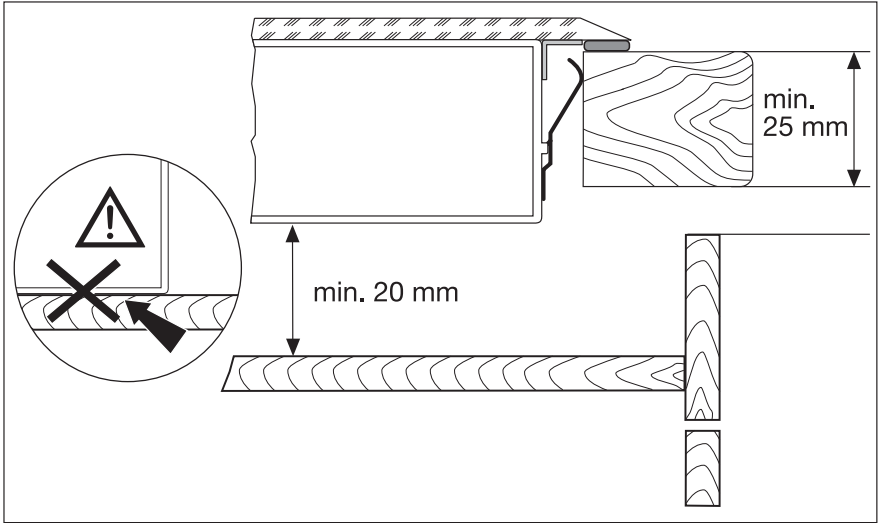





Rating Plate

Modell 76331KF-N		Prod.Nr. 949 592 900	
Typ 55HBD56AO	230 V	50 Hz	
Made in Germany	Ser.Nr.	7,3 kW	
AEG-ELECTROLUX		 	

Guarantee/Customer Service

European Guarantee

This appliance is guaranteed by Electrolux in each of the countries listed at the back of this user manual, for the period specified in the appliance guarantee or otherwise by law. If you move from one of these countries to another of the countries listed below the appliance guarantee will move with you subject to the following qualifications:

- The appliance guarantee starts from the date you first purchased the appliance which will be evidenced by production of a valid purchase document issued by the seller of the appliance.
- The appliance guarantee is for the same period and to the same extent for labour and parts as exists in your new country of residence for this particular model or range of appliances.
- The appliance guarantee is personal to the original purchaser of the appliance and cannot be transferred to another user.
- The appliance is installed and used in accordance with instructions issued by Electrolux and is only used within the home, i.e. is not used for commercial purposes.
- The appliance is installed in accordance with all relevant regulations in force within your new country of residence.

The provisions of this European Guarantee do not affect any of the rights granted to you by law.

www.electrolux.com

		
Albania	+35 5 4 261 450	Rr. Pjeter Bogdani Nr. 7 Tirane
Belgique/België/ Belgien	+32 2 363 04 44	Bergensesteenweg 719, 1502 Lembeek
Česká republika	+420 2 61 12 61 12	Budějovická 3, Praha 4, 140 21
Danmark	+45 70 11 74 00	Sjællandsgade 2, 7000 Fredericia
Deutschland	+49 180 32 26 622	Muggenhofer Str. 135, 90429 Nürnberg
Eesti	+37 2 66 50 030	Mustamäe tee 24, 10621 Tallinn
España	+34 902 11 63 88	Carretera M-300, Km. 29,900 Alcalá de Henares Madrid
France	www.electrolux.fr	
Great Britain	+44 8705 929 929	Addington Way, Luton, Bedfordshire LU4 9QQ
Hellas	+30 23 10 56 19 70	4 Limnou Str., 54627 Thessaloniki
Hrvatska	+385 1 63 23 338	Slavonska avenija 3, 10000 Zagreb
Ireland	+353 1 40 90 753	Long Mile Road Dublin 12
Italia	+39 (0) 434 558500	C.so Lino Zanussi, 26 - 33080 Porcia (PN)
Latvija	+37 17 84 59 34	Kr. Barona iela 130/2, LV-1012, Riga
Lithuania	+3702780607	Žirmūnų 67, LT-09001 Vilnius
Luxembourg	+352 42 431 301	Rue de Bitbourg, 7, L-1273 Hamm
Magyarország	+36 1 252 1773	H-1142 Budapest XIV, Erzsébet királyné útja 87

		
Nederland	+31 17 24 68 300	Vennootsweg 1, 2404 CG - Alphen aan den Rijn
Norge	+47 81 5 30 222	Risløkkvn. 2 , 0508 Oslo
Österreich	+43 18 66 400	Herziggasse 9, 1230 Wien
Polska	+48 22 43 47 300	ul. Kolejowa 5/7, Warszawa
Portugal	+35 12 14 40 39 39	Quinta da Fonte - Edifício Gonçalves Zarco - Q 35 2774 - 518 Paço de Arcos
Romania	+40 21 451 20 30	Str. Garii Progresului 2, S4, 040671 RO
Schweiz/Suisse/ Svizzera	+41 62 88 99 111	Industriestrasse 10, CH-5506 Mägenwil
Slovenija	+38 61 24 25 731	Electrolux Ljubljana d.o.o. Gerbičeva 98, 1000 Ljubljana
Slovensko	+421 2 43 33 43 22	Electrolux Slovakia s.r.o., Electrolux Domáce spotrebiče SK, Seberínho 1, 821 03 Bratislava
Suomi	www.electrolux.fi	
Sverige	+46 (0)771 76 76 76	Electrolux Service, S:t Göransgatan 143, S-105 45 Stockholm
Türkiye	+90 21 22 93 10 25	Tarlabası caddesi no : 35 Taksim Istanbul
Россия	+7 495 937 7837	129090 Москва, Олимпийский проспект, 16, БЦ „Олимпик“
Україна	+380 44 586 20 60	04074 Київ, вул.Автозаводська, 2а, БЦ „Алкон“

Service

In the event of technical faults, please first check whether you can remedy the problem yourself with the help of the operating instructions (section "What to do if...").

If you were not able to remedy the problem yourself, please contact the Customer Care Department or one of our service partners.

In order to be able to assist you quickly, we require the following information:

- Model description
- Product number (PNC)
- Serial number (S No.)
(for numbers see rating plate)
- Type of fault
- Any error messages displayed by the appliance
- three digit letter-number combination for glass ceramic

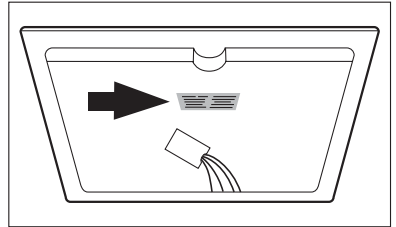

So that you have the necessary reference numbers from your appliance at hand, we recommend that you write them in here:

Model description:

PNC:

S No:

