

# ***Micro Hi-Fi Component System***

---

## Operating Instructions

### Owner's Record

The model and serial numbers are located on the rear of the unit. Record the serial number in the space provided below. Refer to them whenever you call upon your Sony dealer regarding this product.

Model No. \_\_\_\_\_

Serial No. \_\_\_\_\_



***CMT-DX2D  
CMT-SX2D***

## WARNING

**To reduce the risk of fire or electric shock, do not expose this apparatus to rain or moisture.**

To prevent fire, do not cover the ventilation of the apparatus with news papers, table-cloths, curtains, etc. And don't place lighted candles on the apparatus.

To prevent fire or shock hazard, do not place objects filled with liquids, such as vases, on the apparatus.

Do not install the appliance in a confined space, such as a bookcase or built-in cabinet.

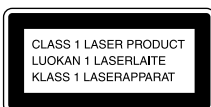



This appliance is classified as a CLASS 1 LASER product. This marking is located on the rear exterior.





Don't throw away the battery with general house waste, dispose of it correctly as chemical waste.

## NOTICE FOR THE CUSTOMERS IN THE UNITED KINGDOM

A moulded plug complying with BS1363 is fitted to this equipment for your safety and convenience. Should the fuse in the plug supplied need to be replaced, a fuse of the same rating as the supplied one and approved by ASTA or BSI to BS1362, (i.e., marked with  or  mark) must be used.

If the plug supplied with this equipment has a detachable fuse cover, be sure to attach the fuse cover after you change the fuse. Never use the plug without the fuse cover. If you should lose the fuse cover, please contact your nearest Sony service station.

## NOTICE FOR THE CUSTOMERS IN THE U.S.A.

	<b>CAUTION</b> RISK OF ELECTRIC SHOCK DO NOT OPEN	
CAUTION: TO REDUCE THE RISK OF ELECTRIC SHOCK, DO NOT REMOVE COVER (OR BACK). NO USER-SERVICEABLE PARTS INSIDE. REFER SERVICING TO QUALIFIED SERVICE PERSONNEL.		



This symbol is intended to alert the user to the presence of uninsulated "dangerous voltage" within the product's enclosure that may be of sufficient magnitude to constitute a risk of electric shock to persons.



This symbol is intended to alert the user to the presence of important operating and maintenance (servicing) instructions in the literature accompanying the appliance.

## CAUTION

The use of optical instruments with this product will increase eye hazard.

## WARNING

This equipment has been tested and found to comply with the limits for a Class B digital device, pursuant to Part 15 of the FCC Rules. These limits are designed to provide reasonable protection against harmful interference in a residential installation. This equipment generates, uses, and can radiate radio frequency energy and, if not installed and used in accordance with the instructions, may cause harmful interference to radio communications. However, there is no guarantee that interference will not occur in a particular installation. If this equipment does cause harmful interference to radio or television reception, which can be determined by turning the equipment off and on, the user is encouraged to try to correct the interference by one or more of the following measures:

- Reorient or relocate the receiving antenna.
- Increase the separation between the equipment and receiver.
- Connect the equipment into an outlet on a circuit different from that to which the receiver is connected.
- Consult the dealer or an experienced radio/TV technician for help.

## CAUTION

You are cautioned that any changes or modifications not expressly approved in this manual could void your authority to operate this equipment.

## Note to CATV system installer:

This reminder is provided to call the CATV system installer's attention to Article 820-40 of the NEC that provides guidelines for proper grounding and, in particular, specifies that the cable ground shall be connected to the grounding system of the building, as close to the point of cable entry as practical.

## **NOTICE FOR THE CUSTOMERS IN CANADA**

### **CAUTION**

The use of optical instruments with this product will increase eye hazard.



**Disposal of Old Electrical & Electronic Equipment  
(Applicable in the European Union and other European countries with separate collection systems)**

This symbol on the product or on its packaging indicates that this product shall not be treated as household waste. Instead it shall be handed over to the applicable collection point for the recycling of electrical and electronic equipment. By ensuring this product is disposed of correctly, you will help prevent potential negative consequences for the environment and human health, which could otherwise be caused by inappropriate waste handling of this product. The recycling of materials will help to conserve natural resources. For more detailed information about recycling of this product, please contact your local Civic Office, your household waste disposal service or the shop where you purchased the product.

# Table of Contents

How to use this manual.....	6
Playable discs.....	6

---

## Getting Started

Hooking up the system.....	9
Setting the clock.....	13
Selecting a language .....	13

---

## Disc - Play

Loading a disc .....	14
Playing a disc .....	14
— Normal Play/Shuffle Play	
Playing DVDs using the menu.....	16
Playing VIDEO CDs with PBC functions (Ver. 2.0).....	17
— PBC Play	
Playing repeatedly.....	18
— Repeat Play	
Creating your own program .....	19
— Program Play	
Using the on-screen display to search .....	20

---

## Disc - Various functions

Changing the sound/subtitle/angle.....	21
Changing the language.....	22
— Language	
Adjusting the image and audio settings .....	23
— AV	
Restricting disc playback .....	25
— Rating (Parental Control)	
System setup item list .....	26

---

## Tuner

Presetting radio stations .....	28
Listening to the radio .....	29
— Preset Tuning	
— Manual Tuning	
Using the Radio Data System (RDS)....	30
(European model only)	

---

## Tape - Play

Loading a tape .....	31
Playing a tape .....	31

---

## Tape - Recording

Recording your favorite CD tracks on a tape .....	31
— CD-TAPE Synchro Recording	
Recording on a tape manually .....	32
— Manual Recording	

---

## Sound Adjustment

Selecting the sound effect.....	33
Singing along .....	33
(CMT-SX2D Asian and Oceanian models only)	

---

## Timer

Falling asleep to music .....	35
— Sleep Timer	
Waking up to music.....	35
— Play Timer	
Timer recording radio programs.....	36
— Rec Timer	

---

## Display

Turning off the display .....	37
— Power Saving Mode	
Adjusting the brightness of the indicators .....	37
Viewing information about the disc in the display .....	38
Viewing information about the disc in the on-screen display.....	39
Viewing the tuner information in the display .....	39

---

## Optional Components

Controlling the TV with the remote .....	40
Using the THEATRE SYNC function .....	40
Hooking up optional components .....	41
Listening to audio from a connected component .....	42
Enjoying the 5.1 channel sound with the optional amplifier .....	42
Recording audio from a connected component .....	43
Recording on a connected component .....	43

---

## Troubleshooting

Problems and remedies .....	44
Messages .....	48





---

## Additional Information

Precautions .....	49
Specifications .....	51
Glossary .....	53
List of button locations and reference pages .....	56

## How to use this manual

- This manual mainly explains operations using the remote, but the same operations can also be performed using the buttons on the unit having the same or similar names.
- The OSD (on-screen display) may vary depending on the country model.
- The English OSD screen (on-screen display) is used for illustration purposes only.
- “DVD” may be used as a general term for DVD VIDEOS, DVD+RWs/DVD+Rs and DVD-RWs/DVD-Rs.
- The following symbols are used in this manual.

Symbol	Meaning
	Functions available for DVD VIDEOS, DVD-Rs/DVD-RWs in video mode, and DVD+Rs/DVD+RWs
	Functions available for VIDEO CDs (including Super VCDs or CD-Rs/CD-RWs in video CD format or Super VCD format)
	Functions available for music CDs or CD-Rs/CD-RWs in music CD format
	Functions available for DATA CDs (CD-ROMs/CD-Rs/CD-RWs containing MP3* audio tracks and JPEG image files)

\*MP3 (MPEG1 Audio Layer 3) is a standard format defined by ISO/MPEG which compresses audio data.

## Playable discs

You can play back the following discs on this system. Other discs cannot be played back.

### List of playable discs

Format of discs	Disc logo
DVD VIDEOS	
DVD-RWs/ DVD-Rs	 
DVD+RWs/ DVD+Rs	  DVD + ReWritable      DVD + R
VIDEO CDs	
Audio CDs	
CD-Rs/CD-RWs	   

“DVD VIDEO,” “DVD-R” and “DVD-RW” logos are trademarks.

---

## Region code of DVDs you can play on this system

Your system has a region code printed on the back of the unit and will only play DVDs labeled with identical region code.

DVDs labeled  will also be played on this system.

If you try to play any other DVD, the message "Playback Prohibited by Area Limitations." will appear on the TV screen. Depending on the DVD, no region code indication may be labeled even though playing the DVD is prohibited by area restrictions.

---

## Discs that this system cannot play

- CD-ROMs (except for extension ".MP3", ".JPG" or ".JPEG")
- CD-Rs/CD-RWs other than those recorded in the following formats:
  - music CD format
  - video CD format
  - MP3 (MPEG1 Audio Layer-3)/JPEG format that conforms to ISO9660\* Level 1/Level 2 or Joliet
- CD-ROMs recorded in PHOTO CD format.
- Data part of CD-Extras
- Super Audio CDs
- DVD-ROMs
- DVD-RAMs
- DVD Audio discs
- A DVD with a different region code.
- DVD+R DL (Double layer) discs
- DVD-RWs recorded in VR (Video Recording) mode
- Photo-movies created after shooting on a DVD camcorder in VR (Video Recording format) mode
- Discs with non-standard shapes (e.g., heart, square, star) cannot be played on this unit. Attempting to do so may damage the unit. Do not use such discs.
- A disc with paper or stickers on it.
- A disc that has the adhesive, cellophane tape, or a sticker still left on it.

\* A logical format of files and folders on a CD-ROMs, defined by ISO (International Organization for standardization).

---

## Notes about CD-R/CD-RW/ DVD-R/DVD-RW (Video mode)/ DVD+R/DVD+RW

- In some cases, CD-Rs, CD-RWs, DVD-Rs, DVD-RWs (Video mode) (DVD-RWs created in video mode have the same format as a DVD VIDEO), DVD+R or DVD+RW cannot be played on this system depending upon the recording quality or physical condition of the disc, or the characteristics of the recording device. Furthermore, the disc will not play if it has not been correctly finalized. For more information, see the operating instructions for the recording device. Note that some playback functions may not work with some DVD+RWs/ DVD+Rs, even if they have been correctly finalized.
- A disc recorded in packet write format cannot be played.

---

## Note on playback operations of DVDs and VIDEO CDs

Some playback operations of DVDs and VIDEO CDs may be intentionally set by software producers. Since this system plays DVDs and VIDEO CDs according to the disc contents the software producers designed, some playback features may not be available. Also, refer to the instructions supplied with the DVDs or VIDEO CDs.

---

## Music discs encoded with copyright protection technologies

This product is designed to playback discs that conform to the Compact Disc (CD) standard. Recently, various music discs encoded with copyright protection technologies are marketed by some record companies. Please be aware that among those discs, there are some that do not conform to the CD standard and may not be playable by this product.

---

## Note on DualDiscs

A DualDisc is a two sided disc product which mates DVD recorded material on one side with digital audio material on the other side. However, since the audio material side does not conform to the Compact Disc (CD) standard, playback on this product is not guaranteed.

---

## Cautions when playing a disc that is recorded in Multi Session

- When playing a disc which contains audio tracks in music CD format, MP3 audio tracks and JPEG image files, only the audio tracks in music CD format can be played back.
- CD-R and CD-RW discs recorded in multi-session that have not ended by “closing the session” are not supported.

---

## Copyrights

This product incorporates copyright protection technology that is protected by U.S. patents and other intellectual property rights. Use of this copyright protection technology must be authorized by Macrovision, and is intended for home and other limited viewing uses only unless otherwise authorized by Macrovision. Reverse engineering or disassembly is prohibited.

This system incorporates Dolby<sup>1)</sup> Digital and DTS<sup>2)</sup> Digital Surround System.

<sup>1)</sup> Manufactured under license from Dolby Laboratories. “Dolby” and the double-D symbol are trademarks of Dolby Laboratories.

<sup>2)</sup> Manufactured under license from Digital Theater Systems, Inc. “DTS” and “DTS 2.0 + Digital Out” are trademarks of Digital Theater Systems, Inc.



## Hooking up the system

Perform the following procedures **1** to **6** to hook up your system using the supplied cords and accessories. The terminals on the rear side vary depending on the country model. Be sure to check the connection procedure.

### European and Russian models

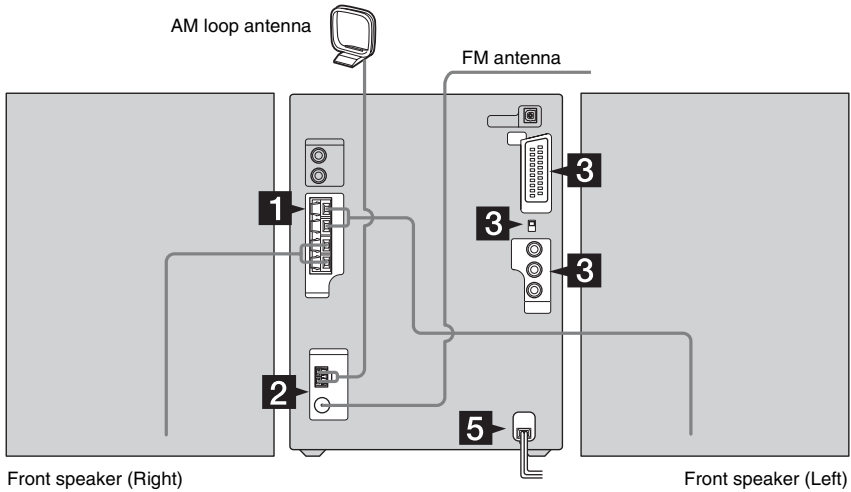

### Other models

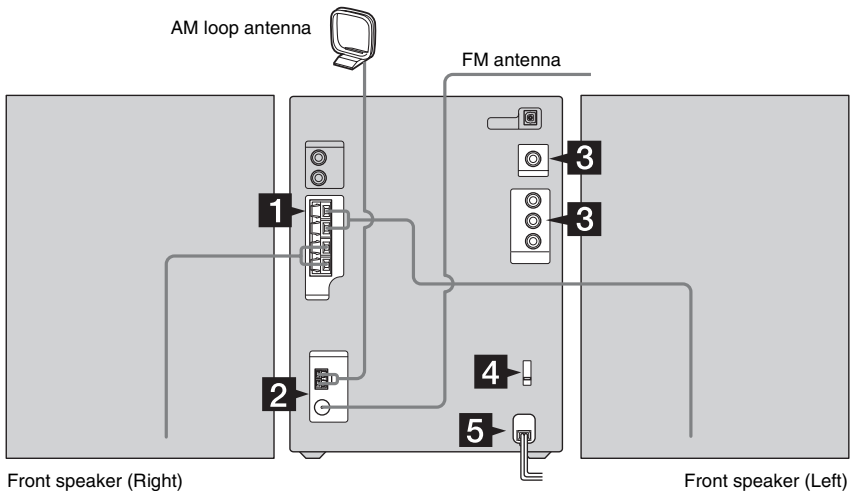

## 1 Connect the speakers.

Connect the right and left speaker cords to the SPEAKER jacks as shown below.

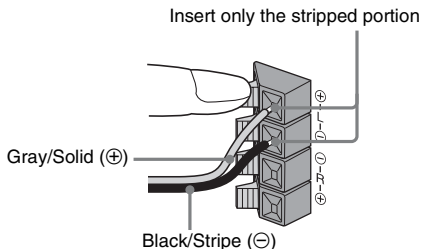

## 2 Connect the FM and AM antennas.

Set up the AM loop antenna, then connect it.

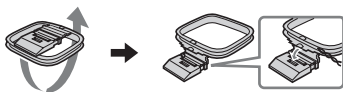

### Plug type (A)

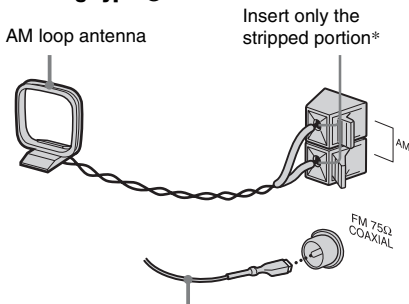

Extend the FM lead antenna horizontally

\* Strip off an end-portion of wire covering.

### Plug type (B)

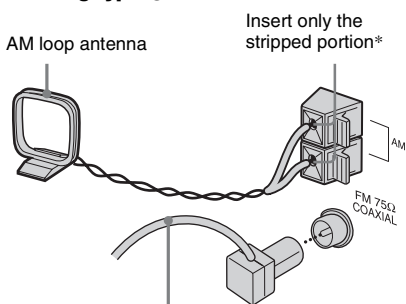

Extend the FM lead antenna horizontally

\* Strip off an end-portion of wire covering.

### Plug type (C)

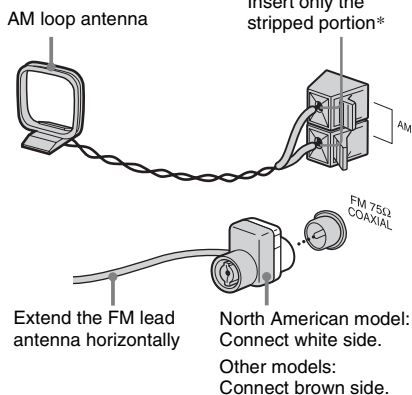

\* Strip off an end-portion of wire covering.

### Note

Keep the antennas away from the speaker cords.

## 3 Connect a TV.

Select one of the following connections.

### Connection (A) (For all models)

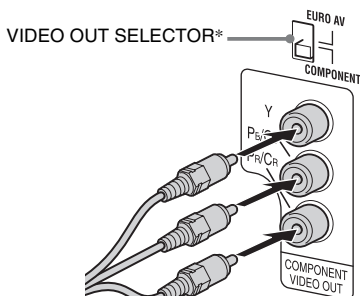

If your TV has component video input jacks, connect your TV to the COMPONENT VIDEO OUT jacks with a component video cord (not supplied). For European and Russian models, make sure to set the VIDEO SELECTOR to COMPONENT.

If your TV is compatible with progressive format file signals, use this connection and set "PROGRESSIVE." For details, see "To change the type of signal output from the system" (page 24).



\* European and Russian models only

**Connection ② (For European and Russian models)**

Connect the  INPUT jack of your TV to the  LINE-TV jack with the SCART cord (not supplied). Make sure to set the VIDEO OUT SELECTOR to EURO AV.

When you connect using the SCART cord, check that the TV conforms to RGB signals. If the TV conforms to RGB signals, change the input mode of the TV to RGB signals. Refer to the operating instructions supplied with the TV to be connected.

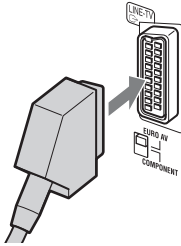
**Note**

Only the video signal will be output through the SCART cord.

**Connection ③ (Except for European and Russian models)**

Connect the video input jack of your TV to the VIDEO OUT jack with the video cable (supplied)\*.

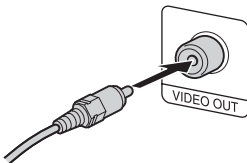

\* except for European and Russian models

**When using a TV**

Turn on the TV and select the video input so that you can view the pictures from this system.

**When connecting a video deck**

Connect the TV and the video deck using video and audio cords (not supplied) as shown below.

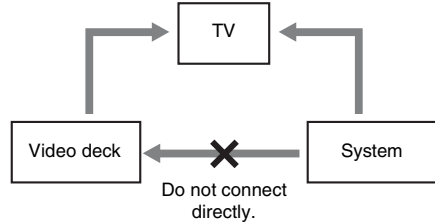

If you connect a video deck between this system and the TV, you may experience video leakage when watching the video signal from this system. Do not connect a video deck between this system and the TV.

**Note**

Do not place the TV on this system.

- 4** For models with a voltage selector, set the **VOLTAGE SELECTOR** to the local power line voltage.

Depending on the model, the **VOLTAGE SELECTOR** may differ.



- 5** Connect the power cord to a wall outlet.

If the supplied adapter on the plug does not fit your wall outlet, detach it from the plug (only for models equipped with an adapter). To turn on the system, press .

**Note**

Install this system so that the power cord can be unplugged from the wall socket immediately in the event of trouble.

**6 (Asian and Oceanian models only)**  
**Set the color system to PAL or NTSC depending on the color system of your TV.**

The color system is factory set to NTSC for region code 3 models, and PAL for other region code models. Each time you perform the procedure below, the color system changes as follows:

NTSC ↔ PAL

**1** Press DVD (or FUNCTION + or – repeatedly) to switch the function to DVD.

Playback starts automatically if a disc with auto playback function is loaded. Press ■ to stop playback.

**2** Press I/⏻ to turn off the system.

**3** Press I/⏻ on the unit while holding down ■ on the unit.

The system turns on and the color system is changed.

**Notes**

- A disturbance in the TV screen may be present for a moment after changing the color system as described above.
- When you play back a VIDEO CD recorded in a different color system from the one you set to the unit, the picture image may be distorted.
- To set the VCD color system, see page 23.

**To connect optional components**

See page 41.

---

**Inserting two R6 (size AA) batteries into the remote**

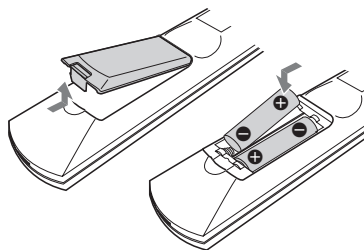

**Note**

If you do not use the remote for a long period of time, remove the batteries to avoid possible damage from battery leakage and corrosion.

**Tip**

With normal use, the batteries should last for about six months. When the remote no longer operates the system, replace both batteries with new ones.

---

**Attaching the speaker pads**

Attach the supplied speaker pads to the bottom of the speakers to stabilize the speakers and prevent them from slipping.

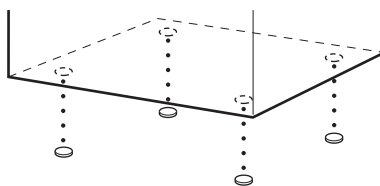

## Setting the clock

Use buttons on the remote for the operation.

- 1** Press I/⏻ to turn on the system.
- 2** Press CLOCK/TIMER SET.
- 3** Press I◀◀ or ▶▶I repeatedly to set the hour.
- 4** Press ENTER.
- 5** Press I◀◀ or ▶▶I repeatedly to set the minute.
- 6** Press ENTER.

The clock starts working.

### To adjust the clock

- 1** Press CLOCK/TIMER SET.
- 2** Press I◀◀ or ▶▶I to select "CLOCK SET," then press ENTER.
- 3** Do the same procedures as step 3 to 6 above.

#### Notes

- The clock settings are canceled when you disconnect the power cord or if a power failure occurs.
- You cannot set the clock in Power Saving Mode (page 37).

## Selecting a language

You can change the on-screen display language.

- 1** Turn on your TV and select the video input.
- 2** Press I/⏻ to turn on the system.
- 3** Press DVD (or FUNCTION + or – repeatedly) to switch the function to DVD.  
Playback starts automatically if a disc with auto playback function is loaded. Press ■ to stop playback.
- 4** Press ☰ DISPLAY in stop mode.
- 5** Press ← or → repeatedly to select "Language," then press ENTER.
- 6** Press ↑ or ↓ repeatedly to select "OSD," then press ENTER.
- 7** Press ↑ or ↓ repeatedly to select a language from the displayed list, then press ENTER.
- 8** Press ☰ DISPLAY to turn off the Setup Display.

## Disc – Play

### Loading a disc

Use buttons on the unit for the operation.

- 1 Press **▲**.
- 2 Place a disc with the label side up on the disc tray.

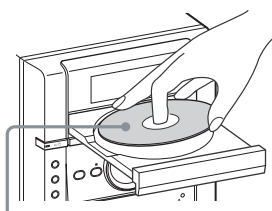

When you play an 8 cm Disc, place it on the inner circle of the tray.

- 3 Press **▲** again to close the disc tray.

#### Notes

- Do not use a disc with tape, seals or paste on it as this may cause malfunction.
- Do not forcibly press the disc tray closed with your finger, as this may cause malfunction.

## Playing a disc

### — Normal Play/Shuffle Play

DVD-V

VIDEO CD

C D

DATR-CD

Before playing a DVD, VIDEO CD or JPEG turn on your TV and select the video input. Depending on the DVD or VIDEO CD, some operations may be different or restricted. Refer to the operating instructions supplied with the disc.

#### Example: When playing a DVD

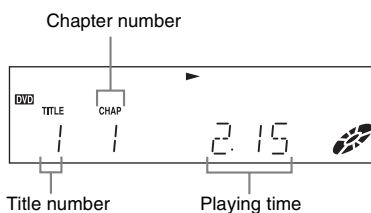

#### Example: When playing a CD

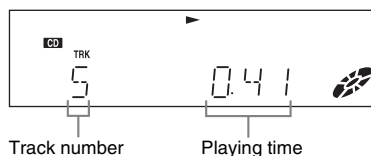

- 1 Press **DVD** (or **FUNCTION + or - repeatedly**) to switch the function to **DVD**.

Playback starts automatically if a disc with auto playback function is loaded.

- 2 Press **▷** (or **DVD ▷||** on the unit). Playback starts.

## Other operations

To	Do this
Stop play	Press ■.
Pause	Press <b>II</b> (or DVD <b>▶II</b> on the unit). <sup>1)</sup> Press <b>II</b> again to go to the next frame (DVD/VIDEO CD only). Press <b>▷</b> (or DVD <b>▶II</b> on the unit) to resume play.
Select a track, image or chapter	Press <b>◀◀</b> or <b>▶▶</b> repeatedly during play or pause. Press <b>◀◀</b> once during play or pause to go back to the beginning of the current track (except for MP3).
Locate a point quickly in fast forward or fast reverse (Scan) (Except for MP3/JPEG) <sup>2)</sup>	Press <b>◀◀</b> or <b>▶▶</b> during play. Each time you press the button, searching speed changes. To return to Normal Play, press <b>▷</b> (or DVD <b>▶II</b> on the unit).
Play all tracks on the disc in random order (Shuffle Play) <sup>3)</sup>	Press PLAY MODE repeatedly in stop mode until “SHUF” appears in the display, then press <b>▷</b> (or DVD <b>▶II</b> on the unit).
Watch frame by frame (Slow-motion Play) (DVD/VIDEO CD only) <sup>1)2)</sup>	During play, press <b>◀ SLOW</b> <sup>4)</sup> or <b>SLOW ▶</b> . Each time you press the button, the playback speed changes. To return to Normal Play, press <b>▷</b> (or DVD <b>▶II</b> on the unit).
Rotate the current image (JPEG only)	Press <b>←</b> or <b>→</b> . Each time you press <b>→</b> , the image turns clockwise by 90°. Each time you press <b>←</b> , the image turns counterclockwise by 90°.
Switch to DVD function from another source	Press DVD <b>▶II</b> on the unit (Automatic Source selection). Playback starts automatically when a disc is loaded.
Cut the sound	Press MUTEING. Press MUTEING again or VOLUME + to restore sound.
Remove a disc	Press <b>▲</b> on the unit.

<sup>1)</sup> There may be some disturbance in the video image.

<sup>2)</sup> For DVDs and VIDEO CDs, no sound is output.

<sup>3)</sup> You cannot perform Shuffle Play on DVDs and VIDEO CDs with PBC function.

<sup>4)</sup> DVD only

## Notes

- Depending on the DVD or VIDEO CD, some operations may be restricted.
- Maximum number of albums on a disc: 100 (The maximum number of MP3 audio tracks or JPEG image files that can be contained on a disc is 999.) However, when a large number of non-MP3/JPEG files are present, the maximum number of albums, tracks and files may decrease.
- For data CD, playback is possible up to 16 levels.
- The system supports MP3 audio tracks recorded with a bit rate of 32 to 320 kbps and a sampling frequency of 32/44.1/48 kHz for MPEG1 Audio Layer-3.
- An album that does not include an MP3 audio track or JPEG image file is skipped.
- If you put the extension “.MP3” to data not in MP3 format, the system cannot recognize the data properly and will generate a loud noise which could damage your speaker system.
- The following discs take a longer time to start playback.
  - a disc recorded with complicated tree structure.
  - a disc recorded in Multi Session.
  - a disc to which data can be added (non-finalized disc).
- Some CD-Rs or CD-RWs cannot be played on this system depending on file format.

## Tip

When playing the data disc contained MP3 audio tracks and JPEG image files, set “Data CD Priority” (page 23).

## Resuming playback from the point you stopped the disc

— *Resume Play (DVD/VIDEO CD/CD only)*

This system memorizes the point where you stopped the disc so you can resume from that point.

- While playing a disc, press **■** to stop playback.  
“RESUME” appears in the display. If “RESUME” does not appear, Resume Play is not available.
- Press **▷** (or DVD **▶II** on the unit).  
The player starts playback from the point you stopped the disc in step 1.

## Notes

- You cannot perform Resume Play during Shuffle Play or Program Play.
- This function may not work properly with some discs.
- Depending on where you stop the disc, the system may not resume playback from exactly the same point.
- Resume play is canceled when:
  - you press ■ in stop mode.
  - you turn off the system.
  - you open the disc tray.
  - you change the play mode.
  - you change the function.

## Playing a track by entering the track number in Normal Play mode (on the remote only)

Press the number button(s) to enter the track number of the track you want to play.

### To enter a track number over 10

- 1 Enter the corresponding digits.
- 2 Press ENTER.

### Example:

To play track number 30, press 3 and 0, then press ENTER.

## Selecting an album/track/file using the on-screen display (MP3/JPEG only)

Press **↑/↓/←/→** repeatedly to select a track or file, then press ENTER.

The selected track or file starts playing.

## Notes

- On the TV screen, up to 16 characters can be displayed for album names, and up to 11 characters for track/file names. When multiple album names use the same first 16 characters, the tracks and files in those albums are displayed together in a single folder.
- Only the letters in the alphabet and numbers can be used for album or file names. Anything else is displayed as “-”.
- If an MP3 audio track is played, indicated elapsed time may be different from the actual time.

## Playing DVDs using the menu

### DVD-V

A DVD is divided into a lot of sections, which make up a picture or music feature. These sections are called “titles.” When you play a DVD which contains several titles, you can select the title you want using TOP MENU. When you play DVDs that allow you to select items such as the language for the subtitles and the language for the sound, select these items using MENU.

### 1 Press TOP MENU or MENU.

The disc’s menu appears on the TV screen. The contents of the menu vary from disc to disc.

### 2 Press **↑/↓/←/→** or the number buttons to select the item you want to play or change.

### 3 Press ENTER.



## Playing VIDEO CDs with PBC functions (Ver. 2.0)

### — PBC Play

#### VIDEO CD

You can use PBC\* menus on your TV screen to enjoy the disc's interactive software. The menu format and structure may differ depending on each disc.

\* PBC: Playback Control

- 1 Press DVD (or FUNCTION + or – repeatedly) to switch the function to DVD.**
- 2 Press ▷ (or DVD ►|| on the unit) to start playing a VIDEO CD with PBC functions (Ver. 2.0).**  
The PBC menu appears on the TV screen.
- 3 Press the number buttons to select the item number you want.**
- 4 Press ENTER.**
- 5 Continue playback according to the instructions on the menus to enjoy interactive playback.**

Refer to the operating instructions supplied with the disc, as the operating procedure may differ according to the VIDEO CD.

### To go back to a previous menu

Press ↶ RETURN.

#### Note

Depending on the VIDEO CD, "Press ENTER" in step 4 may appear as "Press ▷" in the operating instructions supplied with the disc. In this case, press ENTER.

### To cancel playback with PBC functions

- 1 Press ■ twice to cancel Resume Play (page 15).**
- 2 Press MENU repeatedly until "PBC Off" appears.**
- 3 Press ▷ (or DVD ►|| on the unit).** Playback starts from the selected track. Still images, such as the menu screens, will not be shown.  
To return to PBC playback, repeat steps 1 through 3, selecting "PBC On" in step 2.

## Playing repeatedly

### — Repeat Play

VIDEO CD

C D

DATA-CD

You can play all the tracks/files or a single track/file on a disc repeatedly.

---

## Using the front panel display

Press REPEAT during play until “REP” or “REP1” appears.

REP: For all the tracks/files on the disc.

REP1: For a single track/file only.

### To cancel Repeat Play

Press REPEAT repeatedly until both “REP” and “REP1” disappear.

#### Notes

- You cannot perform Repeat Play during PBC playback of VIDEO CDs (page 17).
- When you select “REP1,” that track/file is repeated endlessly until “REP1” is canceled.

---

## Using the on-screen display

Press REPEAT repeatedly during play.

Each time you press the button, the setting changes cyclically as follows:

- Off: does not play repeatedly.
- Repeat All: repeats all the tracks/files on a disc.
- Repeat Track: repeats the current track/file.

### To cancel Repeat Play

Select “Off.”

#### Notes

- You cannot perform Repeat Play during PBC playback of VIDEO CDs (page 17).
- Repeat Play is canceled when:
  - you turn off the system.
  - you open the disc tray.
  - you switch to other functions except DVD.
  - you search for a track/file.

# Creating your own program

## — Program Play

VIDEO CD   C D   DATA-CD

You can make a program of up to 12 steps. You can synchro record the programmed tracks onto a cassette tape (page 32). The program operation can only be set using the TV screen.

- 1 Press DVD (or FUNCTION + or – repeatedly) to switch the function to DVD.**
- 2 Press PLAY MODE repeatedly in stop mode until the Program Display appears on the TV screen.**

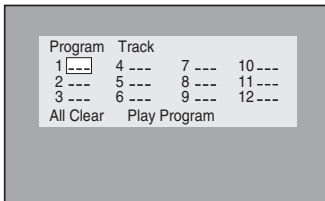

- 3 Press ↑/↓/←/→ repeatedly to select the desired step number.**
- 4 Press the number buttons to select the track you want to program.**

If you make a mistake, press CLEAR to cancel the number, then select another number.

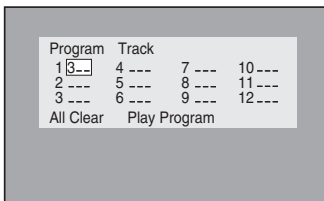

- 5 To program other tracks, repeat steps 3 and 4.**
- 6 Press ↑/↓/←/→ repeatedly to select “Play Program,” then press ▷ (or DVD ►|| on the unit).**

Program Play starts.

## Other operations

To	Do this
Cancel Program Play	Press PLAY MODE repeatedly in stop mode until “Continue” appears.
Clear a programmed step	Press ↑/↓/←/→ repeatedly to select a step number, then press CLEAR in stop mode.
Clear all the programmed steps	Press ↑/↓/←/→ repeatedly to select “All Clear;” then press ENTER.

### Notes

- You cannot perform Program Play with DVDs and VIDEO CDs with PBC function.
- Program Play is canceled when:
  - you turn off the system.
  - you open the disc tray.
  - you switch to other functions except DVD.

### Tip

The program you made remains after Program Play finishes. To play the same program again, press ▷ (or DVD ►|| on the unit).

## Using the on-screen display to search

DVD-V

VIDEO CD

C D

You can search for a chapter (DVD) and track (VIDEO CD, CD). As chapters and tracks are assigned unique numbers on the disc, so you can select the desired one by entering its number. Or, you can search for a particular point using the time code (Time Search).

### Searching for a chapter

- 1 Press SEARCH.**  
The Search Display appears.
- 2 Press ↑ or ↓ repeatedly to select “Chapter.”**
- 3 Press the number buttons to select the desired chapter number.**  
If you make a mistake, press CLEAR to cancel the number, then select another number.
- 4 Press ENTER.**  
Playback starts from the selected number.

### Searching for a track

- 1 Press SEARCH.**  
The Search Display appears.
- 2 Press ↑ or ↓ repeatedly to select “Track.”**
- 3 Press the number buttons to select the desired track number.**  
If you make a mistake, press CLEAR to cancel the number, then select another number.
- 4 Press ENTER.**  
Playback starts from the selected number.

## Searching for a particular point using the time code

### — Time Search

- 1 Press SEARCH.**  
The Search Display appears.
- 2 Press ↑ or ↓ repeatedly to select “Time.”**
- 3 Press the number buttons to input the time code, then press ENTER.**  
When playing a DVD, input the playing time of the current title.  
When playing a VIDEO CD/CD, input the playing time of the current track.  
For example, to find the scene at 2 hours, 10 minutes, and 20 seconds after the beginning, enter “2:10:20”.

#### Note

The time search function does not work on a VIDEO CD (when the PBC function is on).

#### To cancel searching

Press SEARCH repeatedly until the display disappears.

## Disc – Various functions

### Changing the sound/ subtitle/angle

DVD-V

VIDEO CD

C D

#### Changing the sound

If a DVD is recorded with multilingual titles or audio formats, you can select the language or audio format you want while playing the DVD. You can also output either the left or right channel sound from both speakers while playing a VIDEO CD or CD. Note that this results in monaural sound.

#### Press AUDIO repeatedly during play.

Each time you press the button, the setting changes cyclically as follows:

##### ■ When playing a DVD

Depending on the DVD, the choice of the language and audio format varies.

When the same language is displayed twice or more times, the DVD is recorded in multiple audio formats.

##### ■ When playing a VIDEO CD/CD

- Stereo: The standard stereo sound.
- Left: The sound of the left channel (monaural).
- Right: The sound of the right channel (monaural).

#### To preset the desired audio track

You can preset the system to the desired audio track with the operations described under “Changing the language” (page 22).

#### Notes

- When you play a DVD with the audio other than 2 channels, the sound is composed into 2 channels and output from the system speakers. However, sound is not output in “Multi Channel PCM” format.
- For discs not recorded in multiple audio format, you cannot change the sound.
- Depending on the DVD, you may not be able to change the sound even if the DVD is recorded in multiple audio format.

- For VIDEO CDs and CDs, the setting returns to “Stereo” when you turn off the system or open the disc tray.
- During DVD playback, the sound may change automatically.

#### Displaying the audio information of the disc (DVD only)

When you press AUDIO, the channels being played are displayed on the TV screen. For example, in Dolby Digital format, multiple signals ranging from monaural to 5.1 channel signals can be recorded on a DVD. Depending on the DVD, the number of recorded channels may differ.

Current audio format

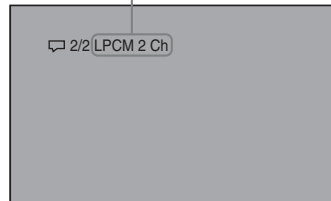

#### The display examples are as follows:

Format	Display
PCM (stereo)	LPCM 2 Ch
Dolby Digital 2 ch	D D 2 Ch
Dolby Digital 5.1 ch	D D 5.1 Ch
DTS	dts 5.1 Ch
MPEG AUDIO	MPEG 2 Ch

continued

---

## Displaying the subtitles (DVD only)

With DVDs on which multilingual subtitles are recorded, you can change the subtitle language while playing a DVD, or turn the subtitles on or off whenever you want.

### Press **SUBTITLE** repeatedly during play.

Each time you press the button, the language changes.

### To cancel the subtitle setting

Press **SUBTITLE** repeatedly to select “Off.”

#### Note

Depending on the DVD, you may not be able to change the subtitles even if multilingual subtitles are recorded on the DVD.

---

## Changing the angles (DVD only)

When playing a DVD on which various angles (multi-angles) for a scene are recorded, you can change the viewing angle.

### Press **ANGLE** repeatedly during play.

Each time you press the button, the angle changes.

#### Note

Depending on the DVD, you may not be able to change the angles even if multi-angles are recorded on the DVD.

## Changing the language

### — Language

**DVD-V**   **VIDEO CD**   **C D**   **DATA-CD**

- 1 Press**  **DISPLAY** in stop mode.  
The Setup Display appears.
- 2 Press** **←** or **→** repeatedly to select “Language,” then press **ENTER**.
- 3 Press** **↑** or **↓** repeatedly to select an item, then press **ENTER**.

#### ■ **OSD (on-screen display)**

Switches the display language on the TV screen. Select the language from the displayed list.

#### ■ **DVD Menu (DVD only)**

Select the language for the DVD menu.

#### ■ **Audio (DVD only)**

Switches the language of the sound track. Select the language from the displayed list.

#### ■ **Subtitle (DVD only)**

Switches the language of the subtitle. Select the language from the displayed list. If “Auto” is selected, the language specified as the disc’s default language is automatically selected.

- 4 Press** **↑** or **↓** repeatedly to select a language, then press **ENTER**.
- 5 Press**  **DISPLAY** to turn off the Setup Display.

#### Note

When the selected language is not recorded on the DVD, one of the recorded languages is automatically selected (except for “OSD”).

#### Tip



You can reset all the DVD settings except for Parental Control by performing the operations described under “To return the DVD setup to the default settings\*,” perform reset as follows:” (page 48).

\* Except for Parental Control settings

# Adjusting the image and audio settings

## — AV

**DVD-V**   **VIDEO CD**   **DATA-CD**

- 1** Press  **DISPLAY** in stop mode.  
The Setup Display appears.
- 2** Press **←** or **→** repeatedly to select “AV,” then press **ENTER**.
- 3** Press **↑** or **↓** repeatedly to select an item, then press **ENTER**.
- 4** Press **↑** or **↓** repeatedly to select a setting, then press **ENTER**.
- 5** Press  **DISPLAY** to turn off the Setup Display.

### ■ TV Type

Select the aspect ratio of the connected TV. The default setting varies, depending on the country model.

4:3 Pan Scan	Select this when you connect a 4:3 screen TV. This setting displays the wide picture on the entire screen and cuts off the portions that do not fit.
4:3 Letter Box	Select this when you connect a 4:3 screen TV. This setting displays a wide picture with bands displayed on the upper and lower portions of the screen.
16:9	Select this when you connect a wide-screen TV or a TV with a wide mode function.

- 4:3 Pan Scan



- 4:3 Letter Box



- 16:9

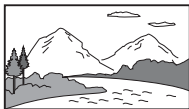

### Note

Depending on the DVD, “4:3 Letter Box” may be selected automatically instead of “4:3 Pan Scan” or vice versa.

### ■ VCD Color Sys (Asian and Oceanian models only)

Select the color system when you play a VIDEO CD. The default setting is underlined.

<u>Auto</u>	Outputs the video signal in the system of the disc, either PAL or NTSC. If your TV uses a dual system, select “Auto.”
NTSC	Changes the video signal of a PAL disc and outputs it in the NTSC system.
PAL	Changes the video signal of an NTSC disc and outputs it in the PAL system.

### ■ Dolby Digital

Set the Dolby Digital settings to enjoy 5.1 channel sound when an optional amplifier is connected (see “Enjoying the 5.1 channel sound with the optional amplifier” (page 42)).

### ■ DTS

Set the DTS settings to enjoy 5.1 channel sound when an optional amplifier is connected (see “Enjoying the 5.1 channel sound with the optional amplifier” (page 42)).

### ■ Data CD Priority (MP3, JPEG only)

Set priority data you want to play, when you play the data disc (CD-ROM/CD-R/CD-RW) contained MP3 audio tracks and JPEG image files. When you change this setting, eject and reload the disc.

The default setting is underlined.

<u>MP3</u>	If an MP3 file exists on the disc, the system recognizes the disc as an MP3 Disc. If only JPEG files exist on the disc, the system recognizes the disc as a JPEG Disc.
JPEG	If a JPEG file exists on the disc, the system recognizes the disc as a JPEG Disc. If only MP3 files exist on the disc, the system recognizes the disc as an MP3 Disc.

## Note

For Asian and Oceanian models, you can change the color system of this unit according to the connected TV (page 12).

## Tip

You can reset all the DVD settings except for Parental Control by performing the operations described under “To return the DVD setup to the default settings\*,” perform reset as follows:” (page 48).

\* Except for Rating (Parental Control) settings

## To change the type of signal output from the system

### — PROGRESSIVE

Progressive is the method for displaying TV images which reduces flickering, and sharpens the image. To display using this method, you need to connect to a TV that accepts progressive signals.

**1** Press DVD (or FUNCTION + or – repeatedly) to switch the function to DVD. Playback starts automatically if a disc with auto playback function is loaded. Press ■ to stop playback.

**2** Press PROGRESSIVE on the unit. Each time you press PROGRESSIVE on the unit, the on-screen display changes as follows:

PROGRESSIVE\* ↔ INTERLACE (default setting)

\* “PROGRESSIVE” appears in the front panel display when the system outputs progressive signals.

### ■ PROGRESSIVE

Select this setting when your TV accepts progressive signals and the TV is connected to the COMPONENT VIDEO OUT jacks.

Normally select this setting under the above condition.

Note that the picture will not be clear or no picture will appear if you select these settings when either of the above conditions is not met.

### ■ INTERLACE (default setting)

Select this setting when your TV does not accept progressive signals or your TV is connected to the ⇨ LINE-TV jack or VIDEO OUT jack.

## About DVD software types and the conversion method

DVD software can be divided into 2 types: film-based software and video-based software.

Video-based software is derived from TV, such as dramas and sit-coms, and displays images at 30 frames/60 fields per second. Film-based software is derived from film and displays images at 24 frames per second. Some DVD software contains both video and film.

In order for these images to appear natural on your screen when output in progressive format, the progressive signals need to be converted to match the type of DVD software that you are watching.

## Note

When you play video-based software in progressive signal format, sections of some types of images may appear unnatural due to the conversion process when output through the COMPONENT VIDEO OUT jacks. Even though you set to “PROGRESSIVE,” images from the VIDEO OUT jack are unaffected as they are output in the interlace format.



## Restricting disc playback

### — Rating (Parental Control)

DVD-V

### Limiting playback by children

You can limit the playback of some DVDs according to a predetermined level such as the age of the users.

When a limited scene is played back, that scene is cut or replaced with a preset other scene.

**1** Press  **DISPLAY** in stop mode.

The Setup Display appears.

**2** Press **←** or **→** repeatedly to select “Rating,” then press **ENTER**.

**3** Press **↓** to select “Rating.”

When a 4-digit password has already been registered, enter the 4-digit password using the number buttons, then press **ENTER**.

You can then select “Rating.”

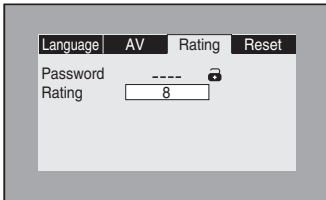

**4** Press **ENTER** repeatedly to select the level you want.

Each time you press the button, the level changes.

The lower the value, the more strict the limitation.

**5** Press **↑** to select “Password.”

**6** Enter or re-enter your 4-digit password using the number buttons, then press **ENTER**.

The lock icon is closed and the Parental Control setting is completed.

If you make a mistake entering your password, press **CLEAR** before you press **ENTER** and input the correct number.

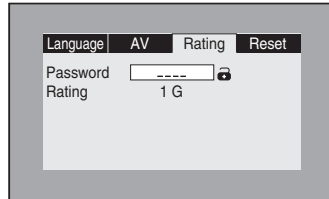

### To turn off the Parental Control function and play the DVD after entering your password

Enter your 4-digit password using the number buttons, then press **ENTER**.

The lock icon is opened and the Parental Control function is turned off.

### To change the password

**1** In step 6, enter your 4-digit password using the number buttons, then press **ENTER**.

**2** Enter a new 4-digit password using the number buttons, then press **ENTER**.

## Playing the disc for which Parental Control is set

**1** Insert the disc and press DVD (or FUNCTION + or – repeatedly) to switch the function to DVD.

The Rating Display appears.

**2** Enter your 4-digit password using the number buttons, then press ENTER.

Playback starts.

### Notes

- When you play DVDs which do not have the Parental Control function, playback cannot be limited on this system.
- Depending on the DVD, you may be asked to change the parental control level while playing the disc. In this case, enter your password, then change the level. If the Resume Play mode is canceled, the level returns to the original level.

### Tip

If you forgot your password, select “Password” and enter “199703” using the number buttons in the Rating Display, then press ENTER. You can then enter a new 4-digit password.

## System setup item list

When you press  DISPLAY, the following settings are displayed.

The default settings are underlined.

### Language (page 22)

OSD	Select the language you want to use from the displayed language list.
DVD Menu	Select the language you want to use from the displayed language list.
Audio	Select the language you want to use from the displayed language list.
Subtitle	Select the language you want to use from the displayed language list.

### AV (pages 23, 42)

TV Type <sup>1)</sup>	4:3 Pan Scan 4:3 Letter Box 16:9
VCD Color Sys <sup>2)</sup>	<u>Auto</u> NTSC PAL
Dolby Digital	<u>PCM</u> Bit Stream
DTS	<u>PCM</u> Bit Stream
Data CD Priority	<u>MP3</u> JPEG

**Rating (page 25)**

---

Password

---

Rating	1 G
	2
	3 PG
	4 PG 13
	5
	6 R
	7 NC 17
	<u>8</u>

---

**Reset (page 48)**

---

Reset	YES
	<u>NO</u>

---

<sup>1)</sup>The default setting varies, depending on the country model.

<sup>2)</sup>Asian and Oceanian models only

## Tuner

# Presetting radio stations

You can preset up to 20 FM stations and 10 AM stations. You can then tune in any of those stations simply by selecting the corresponding preset number.

## Automatic tuning preset

You can automatically tune in all of the stations that can be received in your area and then store the radio frequency of the desired stations.

- 1 Press **TUNER/BAND** repeatedly to select “FM” or “AM.”
- 2 Press and hold **TUNING +** or **–** until the frequency indication starts to change, then release it.

The frequency changes as the system scans for a station. Scanning stops automatically when a station is tuned in. At that time, “TUNED” and “STEREO” (for an FM stereo program) appear.

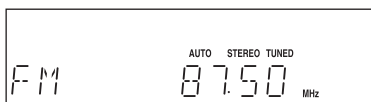

### If “TUNED” does not appear and the scanning does not stop

Set the frequency of the desired radio station as described in steps 2 through 6 of “Manual tuning preset.”

- 3 Press **TUNER MEMORY**.

A preset number flashes.

Perform steps 4 and 5 while the preset number flashes.

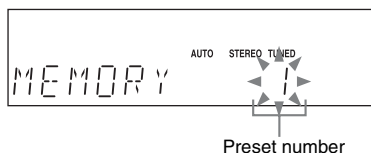

- 4 Press **PRESET +** or **–** repeatedly to select the desired preset number.

- 5 Press **ENTER**.  
“COMPLETE” appears.

- 6 Repeat steps 1 through 5 to store other stations.

## Manual tuning preset

You can manually tune in and store the radio frequency of the desired stations.

- 1 Press **TUNER/BAND** repeatedly to select “FM” or “AM.”
- 2 Press **TUNING +** or **–** repeatedly to tune in the desired station.
- 3 Press **TUNER MEMORY**.  
A preset number flashes.  
Perform steps 4 and 5 while the preset number flashes.
- 4 Press **PRESET +** or **–** repeatedly to select the desired preset number.
- 5 Press **ENTER**.  
“COMPLETE” appears.
- 6 Repeat steps 1 through 5 to store other stations.

## Other operations

To	Do this
Tune in a station with a weak signal	Follow the procedure described in “Manual tuning preset.”
Set another station to the existing preset number	Start over from step 1. After step 3, press <b>PRESET +</b> or <b>–</b> repeatedly to select the preset number you want to store the other station.

## To change the AM tuning interval (except for European and Russian models)

The AM tuning interval is factory-preset to 9 kHz (or 10 kHz for some areas). To change the AM tuning interval, tune in any AM station first, then turn off the system. While holding **■** on the unit, press TUNER/BAND on the unit. When you change the interval, all the AM preset stations are erased. To reset the interval, repeat the same procedure.

### Note

You cannot change the AM tuning interval in Power Saving Mode (page 37).

### Tip

To improve broadcast reception, adjust the supplied antennas, or connect a commercially available external antenna.

## Listening to the radio

You can listen to a radio station either by selecting a preset station, or by manually tuning in the station.

### Listening to a preset station

#### — Preset Tuning

Preset radio stations in the tuner's memory first (see "Presetting radio stations" (page 28)).

- 1** Press TUNER/BAND repeatedly to select "FM" or "AM."
- 2** Press PRESET + or – repeatedly to select the desired preset station.

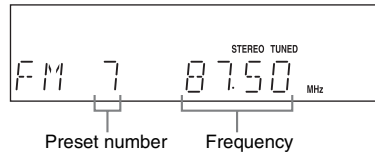

---

## Listening to non-preset radio station

### — Manual Tuning

- 1** Press TUNER/BAND repeatedly to select “FM” or “AM.”
- 2** Press TUNING + or – repeatedly to tune in the desired station.

### To cut the sound

Press MUTING.

Press MUTING again or VOLUME + to restore sound.

### To listen to an FM stereo program without stereo effect

When an FM stereo program has static noise, press FM MODE repeatedly until “MONO” appears. There will be no stereo effect, but the reception will improve.

#### Tips

- To improve broadcast reception, adjust the supplied antennas, or connect a commercially available external antenna.
- Press and hold TUNING + or –. The frequency indication changes and scanning stops when the system tunes in a station (Automatic Tuning).
- To record the radio programs, use manual recording (pages 32 and 36).

## Using the Radio Data System (RDS)

*(European model only)*

---

### What is the Radio Data System?

Radio Data System (RDS) is a broadcasting service that allows radio stations to send additional information along with the regular program signal. This tuner offers convenient RDS features like station name. RDS is available only on FM stations.\*

#### Note

RDS may not work properly if the station you are tuned in is not transmitting the RDS signal properly or if the signal is weak.

\* Not all FM stations provide RDS service, nor do they provide the same types of services. If you are not familiar with the RDS system, check with your local radio stations for details on RDS services in your area.

---

### Receiving RDS broadcasts

#### Simply select a station from the FM band.

When you tune in a station that provides RDS services, the station name appears in the display.

#### To check the RDS information

Each time you press DISPLAY, the display changes cyclically as follows:

Station name<sup>1)</sup> → Preset number<sup>2)</sup> and frequency → Clock display (for a few seconds) → Effect status (for a few seconds)

<sup>1)</sup> If the RDS broadcast is not properly received, the station name may not appear in the display.

<sup>2)</sup> Preset number is displayed only if you preset radio stations (page 28).

## Tape – Play

### Loading a tape

- 1 Press **▲** PUSH OPEN/CLOSE on the unit.
- 2 Load a recorded/recordable tape into the cassette holder.

With the side you want to play/record facing forward.

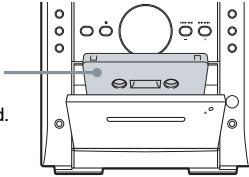

### Playing a tape

You can use TYPE I (normal) tape.

- 1 Load a tape.
- 2 Press **TAPE** (or **FUNCTION +** or – repeatedly) to switch the function to **TAPE**.
- 3 Press **▷** (or **TAPE ▶** on the unit). Playback starts.

### Other operations

To	Do this
Stop play	Press <b>■</b> .
Fast-forward or rewind	Press <b>◀◀</b> or <b>▶▶</b> .
Switch to TAPE function from another source	Press <b>TAPE ▶</b> on the unit. Playback starts automatically when a tape is loaded.
Cut the sound	Press <b>MUTING</b> . Press <b>MUTING</b> again or <b>VOLUME +</b> to restore sound.
Remove a tape	Press <b>▲</b> PUSH OPEN/CLOSE on the unit in stop mode.

## Tape – Recording

### Recording your favorite CD tracks on a tape

#### — CD-TAPE Synchro Recording

You can record a whole CD on a tape. You can use TYPE I (normal) tape.

- 1 Load a recordable tape.
- 2 Load a CD you want to record.
- 3 Press **DVD** (or **FUNCTION +** or – repeatedly) to switch the function to **DVD**.
- 4 Press **CD SYNC** on the unit. The tape deck stands by for recording. “REC” flashes.
- 5 Press **●** REC PAUSE/START on the unit. Recording starts.

#### Tips

- If the tape reaches the end of the front side before completing the recording, the tape stops automatically and the CD/DVD player enters Resume Play mode.
- To continue the recording on the reverse side, press **■** twice to first cancel the Resume Play, eject and reload the tape, then perform steps 1 and 2 of “To perform Synchro Recording from a desired track” (page 31). You can then continue Synchro Recording from the desired track.

### To perform Synchro Recording from a desired track

You can select the first track in Synchro Recording.

- 1 After performing steps 1 to 4, press **◀◀** or **▶▶** repeatedly to select the desired track number.
- 2 Press **●** REC PAUSE/START on the unit while the selected track number is flashing. Recording starts.

## To record a CD by specifying track order

You can record only your favorite CD tracks using Program Play. Between steps 3 and 4, perform steps 2 to 5 of “Creating your own program” (page 19).

## To stop recording

Press ■.

### Notes

- CD Synchro Recording is not available with DVD, VIDEO CD, MP3 audio tracks and JPEG image files.
- You cannot listen to other sources while recording.
- If the play mode is set to Repeat Play or Shuffle Play, it automatically switches to Normal Play in step 4.
- The sound effect automatically switches to “FLAT” in step 4.

## Recording on a tape manually

### — Manual Recording

You can record just the portions you like from a disc (DVD, VIDEO CD, CD and MP3) or radio program on a tape.

You can also record from connected components (see “Hooking up optional components” (page 41)).

Use buttons on the unit for the operation.

- 1 Load a recordable tape.**
- 2 Press one of the following buttons to select the desired source to record.**

- DVD ►||: To record from this system’s CD/DVD player. Playback starts automatically if a disc is loaded. Press ■ to stop playback. To cancel Resume Play, press ■ twice.
- TUNER/BAND: To record from this system’s tuner.
- TV: To record from the optional component connected to TV IN L/R jacks.

- 3 Press ● REC PAUSE/START.**

The tape deck stands by for recording. “REC” flashes.

- 4 Press ● REC PAUSE/START, then start playing the desired source to record.**

Recording starts.

## To stop recording

Press ■.

### Notes

- You cannot listen to other sources while recording.
- If no sound is being recorded when recording from a DVD, set “Dolby Digital” or “DTS” to “PCM” under “AV” in the Setup Display.
- The sound effect automatically switches to “FLAT” in step 3.

### Tip

For recording from the tuner:

If noise is heard while recording from the tuner, move the respective antenna to reduce the noise.



## Sound Adjustment

### Selecting the sound effect

Press **PRESET EQ** repeatedly to select the preset you desire.

The preset name appears in the display.

#### To cancel the sound effect

Press **PRESET EQ** repeatedly until “FLAT” appears in the display.

#### Sound effect options

EQ	Effect
ROCK	Bass and treble are greatly boosted. This gives rock and dance music tracks even more powerful sound.
JAZZ	Bass and treble are somewhat boosted. This makes live instrumental performances such as jazz or other small ensembles sparkle without losing the natural tones of the instruments.
CLASSIC	Unwanted treble is attenuated, letting you enjoy music with a relaxed feeling. This mode is suitable for orchestra, piano solos and other classical music.
TV	Treble is greatly boosted. This makes it easier to hear TV newscasts, drama dialog and other speech.
MP3	Bass is boosted and treble is greatly boosted to compensate the high range that is lost during compression. This lets you enjoy sound that is closer to the original.
MOVIE	Expansive, reverberating sounds are artificially reproduced and the bass is also boosted. This lets you enjoy movies with a full sound-space feeling like being in a movie theater.

## Singing along

*(CMT-SX2D Asian and Oceanian models only)*

You can sing along with a disc by connecting an optional microphone.

### Adjusting the microphone

Use buttons on the unit for the operation.

- 1 Turn **MIC LEVEL** to **MIN** to turn down the microphone control level.
- 2 Connect an optional microphone to the **MIC jack**.
- 3 Start playing the music.
- 4 Adjust the microphone volume by turning **MIC LEVEL**.

#### After you have finished

Turn **MIC LEVEL** to **MIN** and disconnect the microphone from the **MIC jack**.

#### To use VIDEO CDs or DVDs

Turn on your TV and switch it to the appropriate video input.

#### Tip

To sing karaoke of multiplex CD, press **AUDIO** on the remote repeatedly during play to select “Left” or “Right” (see “Changing the sound” (page 21)).

---

## Mixing and recording sounds

You can “mix” sounds by playing one of the components and singing or speaking into a microphone (not supplied).

The mixed sound can be recorded on a tape. Use buttons on the unit for the operation.

- 1 Prepare the source you want to mix.**
- 2 Load a recordable tape.**
- 3 Press the function button of the source you want to record (e.g., DVD ►II).**

When you want to record from a disc, press ■ twice to cancel Resume Play.

- 4 Press ● REC PAUSE/START.**

The tape deck stands by for recording. “REC” flashes.

- 5 Press ● REC PAUSE/START, and then start singing, speaking or playing the desired source.**

Recording starts.

### To stop recording

Press ■.

#### Tips

- If acoustic feedback (howling) occurs, move the microphone away from the speakers or change the direction of the microphone.
- If you want to record your voice through the microphone only, you can do so by selecting the DVD function when a disc is loaded and not playing a disc.

## Timer

### Falling asleep to music

#### — Sleep Timer

You can set the system to turn off after a certain time, so that you can fall asleep to music.

#### Press SLEEP.

Each time you press the button, the minute display (the turn-off time) changes cyclically as follows:

AUTO\* → 90 → 80 → 70 → ... → 10 → OFF

\* The system automatically turns off in 100 minutes or after the current disc or tape finishes playing.

#### Other operations

To	Press
Check the remaining time*	SLEEP once.
Change the time to turn off	SLEEP repeatedly to select the time you want.
Cancel the Sleep Timer Function	SLEEP repeatedly until "SLEEP OFF" appears.

\* You cannot check the remaining time if you select "AUTO."

#### Note

Do not set to "AUTO" during Synchro Recording on a tape.

#### Tip

You can use the Sleep Timer, even if you have not set the clock.

## Waking up to music

### — Play Timer

You can wake up to music at a preset time. Make sure you have set the clock (see "Setting the clock" (page 13)).

Use buttons on the remote for the operation.

#### 1 Prepare the sound source you want to play.

- CD/DVD: Load a disc.
- Tape: Load a tape.
- Tuner: Tune in the preset radio station (see "Listening to the radio" (page 29)).

#### 2 Press CLOCK/TIMER SET.

#### 3 Press ◀◀ or ▶▶ repeatedly to select "PLAY SET," then press ENTER.

"ON" appears and the hour indication flashes.

#### 4 Set the time to start playing.

Press ◀◀ or ▶▶ repeatedly to set the hour, then press ENTER.

The minute indication flashes.

Press ◀◀ or ▶▶ repeatedly to set the minute, then press ENTER.

#### 5 Set the time to stop playing following the same procedure as step 4.

#### 6 Press ◀◀ or ▶▶ repeatedly until the desired sound source appears.

Each time you press the button, the display changes cyclically as follows:



#### 7 Press ENTER.

The type of timer ("PLAY TIMER"), the start time, the stop time, and the sound source appear in turn, before the original display returns.

#### 8 Press VOLUME + or – to adjust the volume.

#### 9 Press I/⏻ to turn off the system.

## Other operations

To	Do this
Check the setting	<ol style="list-style-type: none"><li>1 Press CLOCK/TIMER SELECT.</li><li>2 Press ◀◀ or ▶▶ repeatedly until “PLAY SEL” appears, then press ENTER.</li></ol>
Change the setting	Start over from step 1.
Cancel the timer	<ol style="list-style-type: none"><li>1 Press CLOCK/TIMER SELECT.</li><li>2 Press ◀◀ or ▶▶ repeatedly until “TIMER OFF” appears, then press ENTER.</li></ol>

### Notes

- You cannot activate the Play Timer and Rec Timer at the same time.
- If you use the Play Timer and the Sleep Timer at the same time, the setting with the earlier end time has priority.
- The system turns on 15 seconds before the preset time. Do not operate the system from the time the system turns on until the play starts.
- If the system is on 15 seconds before the preset time, the Play Timer will not be activated.
- You cannot use the optional component connected to TV IN L/R jacks as the sound source for Play Timer.

## Timer recording radio programs

### — Rec Timer

You can record a preset radio station from a specified time.

To timer record, you must first preset the radio station (see “Presetting radio stations” (page 28)) and set the clock (see “Setting the clock” (page 13)).

Use buttons on the remote for the operation.

- 1 Press CLOCK/TIMER SET.**
- 2 Press ◀◀ or ▶▶ repeatedly to select “REC SET,” then press ENTER.**  
“ON” appears and the hour indication flashes.
- 3 Set the time to start recording.**  
Press ◀◀ or ▶▶ repeatedly to set the hour, then press ENTER.  
The minute indication flashes.  
Press ◀◀ or ▶▶ repeatedly to set the minute, then press ENTER.
- 4 Set the time to stop recording following the same procedure as step 3.**  
The type of timer (“REC TIMER”), the start time, the stop time, and “TUNER REC” appear in turn, before the original display returns.
- 5 Load a recordable tape.**
- 6 Tune in the preset radio station (see “Listening to a preset station” (page 29)).**
- 7 Press I/⏻ to turn off the system.**

## Other operations

To	Do this
Check the setting	<ol style="list-style-type: none"><li>1 Press CLOCK/TIMER SELECT.</li><li>2 Press ◀◀ or ▶▶ repeatedly until “REC SEL” appears, then press ENTER.</li></ol>
Change the setting	Start over from step 1.
Cancel the timer	<ol style="list-style-type: none"><li>1 Press CLOCK/TIMER SELECT.</li><li>2 Press ◀◀ or ▶▶ repeatedly until “TIMER OFF” appears, then press ENTER.</li></ol>

### Notes

- You cannot activate the Play Timer and Rec Timer at the same time.
- If you use the Rec Timer and the Sleep Timer at the same time, the setting with the earlier end time has priority.
- The system turns on 15 seconds before the preset time. Do not operate the system from the time the system turns on until the play starts.
- If the system is on 15 seconds before the preset time, the Rec Timer will not be activated.
- The volume is reduced to minimum during recording.
- Note that if the Rec Timer is set at the same time as the Play Timer sound source is set to tape, the Rec Timer sound may be recorded onto the tape.

## Display

### Turning off the display

#### — Power Saving Mode

The clock display can be turned off to minimize the amount of power consumed during standby (Power Saving Mode).

**Press DISPLAY repeatedly while the system is off until the clock display disappears.**

#### To cancel Power Saving Mode

Press DISPLAY while the system is off. Each time you press the button, the display switches as follows:

Clock display\* ↔ No display (Power Saving Mode)

\* The clock is displayed only if you set the clock.

#### Tips

- The timer continues to operate in Power Saving Mode.
- I/⏻ indicator lights up even in Power Saving Mode.

### Adjusting the brightness of the indicators

**Press DIMMER repeatedly.**

Each time you press the button, the setting changes cyclically as follows:

DIMMER OFF → DIMMER 1 → DIMMER 2\*

\* DIMMER 2 is the darkest.

## Viewing information about the disc in the display

You can check the playing time and remaining time of the current track or that of the disc.

### Checking the disc information (DVD/VIDEO CD/CD/MP3/JPEG)

Press **DISPLAY**.

Each time you press the button, the display changes cyclically as follows:

#### ■ When playing a DVD

Elapsed playing time of the current title →  
Remaining time of the current chapter →  
Remaining time of the current title → Clock display (for a few seconds) → Effect status (for a few seconds)

#### ■ When playing a CD/VIDEO CD without PBC function

Elapsed playing time of the current track →  
Remaining time of the current track →  
Remaining time of the disc<sup>1)</sup> → Clock display (for a few seconds) → Effect status (for a few seconds)

#### ■ When playing a VIDEO CD with PBC functions (Ver. 2.0)

Elapsed playing time on the current track<sup>2)</sup> →  
Clock display (for a few seconds) → Effect status (for a few seconds)

#### ■ When playing an MP3

Elapsed playing time of the current track →  
Clock display (for a few seconds) → Effect status (for a few seconds)

#### ■ When playing a JPEG

Current file number → Clock display (for a few seconds) → Effect status (for a few seconds)

#### ■ When you press **DISPLAY** in stop mode

Total title/track number of the disc and total playing time of the current disc<sup>3)</sup> → Clock display (for a few seconds) → Effect status (for a few seconds)

- <sup>1)</sup> These are not displayed during Shuffle Play or Program Play.
- <sup>2)</sup> May not appear with still images.
- <sup>3)</sup> VIDEO CDs and CDs only

## Viewing information about the disc in the on-screen display

You can check the playing time and remaining time of the current title, chapter or track.

### Press DISPLAY.

Each time you press the button, the display changes cyclically as follows:

#### ■ When playing a DVD

Elapsed playing time of the current title →  
Remaining time of the current chapter →  
Remaining time of the current title

#### ■ When playing a VIDEO CD

Elapsed playing time of the current track →  
Remaining time of the current track\* →  
Remaining time of the current disc\*

#### ■ When playing a CD

Elapsed playing time of the current track →  
Remaining time of the current track →  
Remaining time of the current disc

#### ■ When playing an MP3

Elapsed playing time of the current track

#### ■ When playing a JPEG

Current file number and total number of files

\* When playing a VIDEO CD without PBC function

### To turn off the display

Press DISPLAY repeatedly until the display disappears.

## Viewing the tuner information in the display

Press DISPLAY while listening to the radio.

Each time you press the button, the display changes cyclically as follows:  
Station name<sup>1)</sup> → Preset number<sup>2)</sup> and frequency → Clock display (for a few seconds) → Effect status (for a few seconds)

<sup>1)</sup>European model only

<sup>2)</sup>Preset number is displayed only if you preset radio stations (page 28).

## Optional Components

# Controlling the TV with the remote

You can use the following buttons on the remote to operate a Sony TV.

To	Press
Turn the TV on or off	TV I/⏻ while holding down the TV button
Switch the TV's input source between the TV and other input sources	TV/VIDEO while holding down the TV button
Change the TV channels	TV CH +/- or the number buttons while holding down the TV button
Adjust the volume of the TV speaker(s)	TV VOL +/- while holding down the TV button

## Using the THEATRE SYNC function

THEATRE SYNC allows you to turn on your SONY TV and this system, change the system mode to "DVD," and then switch the TV's input source you set with one button push.

Use the remote for the operation.

- 1 Press and hold TV/VIDEO while entering the code for the TV's input source connected to this system (see the table below) using the number buttons.**

TV's input source is selected.

Number	TV's input source
0	No input source (Default)
1	VIDEO1
2	VIDEO2
3	VIDEO3
4	VIDEO4
5	VIDEO5
6	VIDEO6
7	VIDEO7
8	VIDEO8

Number	TV's input source
9	COMPONENT 1 INPUT
CLEAR	COMPONENT 2 INPUT
PRESET EQ	COMPONENT 3 INPUT
ENTER	COMPONENT 4 INPUT

- 2 Press and hold TV CH + while entering the code for transmit time (see the table below) using the number buttons.**

The transmit time from the remote is selected.

Number	Transmit time
1	0.5 (Default)
2	1
3	1.5
4	2
5	2.5
6	3
7	3.5
8	4

### Notes

- This function is only for SONY TV series, however, some TV products may also not work.
- If this function does not work, change the transmit time. The transmit time varies depending on the TV.
- If distance between the TV and this system is too far, this function may not work. Install the system near the TV.
- Keep the remote pointed in the direction of the TV and this system.
- For European and Russian models, if the ⇨ LINE-TV jack and COMPONENT VIDEO OUT jacks are both connected to a TV, pressing the THEATRE SYNC button may not switch the TV's input source, depending on the TV.



# Hooking up optional components

To enhance your system, you can connect optional components. Refer to the operating instructions provided with each component. North American model is used for illustration purpose.

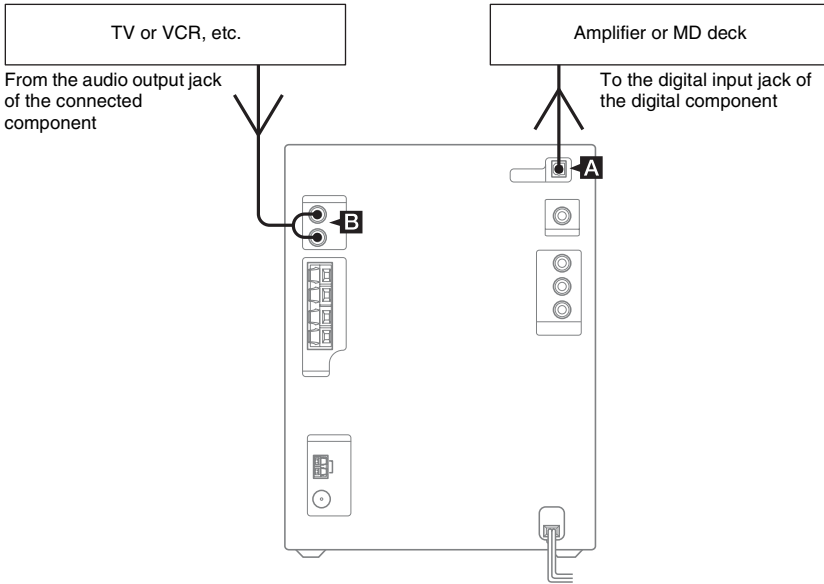

## **A** DIGITAL OUT (OPTICAL) jack

Use a digital optical cord (square, not supplied) to connect an amplifier, MD deck or DAT deck with a digital optical input jack. Sound is then output when the system function is set to DVD. By connecting this system to the optical input jack of the optional amplifier equipped with Dolby Digital or DTS decoder, you can enjoy the 5.1 channel sound.

In addition, when the CD or DVD audio is linear PCM, you can make a digital recording from this system to an MD deck or DAT deck.

### **Notes**

- When playing MP3 audio tracks, you cannot output digital audio.
- You can record digital audio from this system only when DVD function is selected.

- You cannot make a digital recording of a copy guarded disc using a digital component connected to this system. Also, playback may not be possible depending on the connected component.
- When you connect a component that does not support Dolby Digital or DTS to the DIGITAL OUT (OPTICAL) jack and output a Dolby Digital or DTS bit stream, noise may be heard from the connected component.

## **B** TV IN L/R jacks









Use audio cords (not supplied) to connect an optional analog component (TV or VCR, etc.) to these jacks. You can then record or listen to from the component through this system.

## Listening to audio from a connected component

Use buttons on the unit for the operation.

- 1 Connect audio cords.**  
See “Hooking up optional components” (page 41).
- 2 Turn the VOLUME control towards – to turn down the volume.**
- 3 Press TV to switch the function to TV.**
- 4 Start playing the connected component.**
- 5 Turn the VOLUME control to adjust the volume.**

## Enjoying the 5.1 channel sound with the optional amplifier

- 1 Connect a digital optical cord.**  
See “Hooking up optional components” (page 41).
- 2 Connect 6 speakers to an AV amplifier equipped with a decoder.**  
For the speaker placement, refer to the operating instructions supplied with the connected amplifier.
- 3 Press  DISPLAY in stop mode.**  
The Setup Display appears.
- 4 Press  or  repeatedly to select “AV,” then press ENTER.**
- 5 Press  or  repeatedly to select “Dolby Digital” or “DTS,” then press ENTER.**
- 6 Press  or  repeatedly to select “Bit Stream,” then press ENTER.**
- 7 Press  DISPLAY to turn off the Setup Display.**
- 8 Switch the output to 5.1 channel Dolby Digital sound or 5.1 channel DTS sound.**  
See “Changing the sound/subtitle/angle” (page 21).

## Recording audio from a connected component

- 1 Connect audio cords.**  
See “Hooking up optional components” (page 41).
- 2 Start recording manually.**  
See “Recording on a tape manually” (page 32).

## Recording on a connected component

- 1 Connect a digital optical cord.**  
See “Hooking up optional components” (page 41).
- 2 Press DVD (or FUNCTION + or – repeatedly) to switch the function to DVD.**  
Playback starts automatically if a disc with auto playback function is loaded. Press ■ to stop playback. To cancel Resume Play, press ■ twice.
- 3 Start recording with the connected digital component (MD deck, etc.).**  
Refer to the operating instructions provided with the connected component.
- 4 Press ▷ (or DVD ►|| on the unit) to start playing.**

### Notes

- You cannot make a digital recording in the following cases.
  - Copy guarded DVDs
  - DVD Dolby Digital or DTS bit stream output
  - CD-Rs/CD-RWs recorded in music CD format
- You cannot make a recording when “Dolby Digital” or “DTS” under “AV” is set to “Bit Stream.”

## Troubleshooting

### Problems and remedies

Should you encounter a problem with your system, do the following:

- 1 Make sure the power cord and speaker cords are correctly and firmly connected.
- 2 Find your problem in the troubleshooting checklist below and take the indicated corrective action.

If the problem persists after doing all of the above, consult your nearest Sony dealer. Note that if service personnel changes some parts during repair, these parts may be retained.

#### When the I/⏻ indicator flashes

Immediately unplug the power cord and check the following items.

- If your system has a voltage selector, is the voltage selector set to the correct voltage? Check the voltage for your region, then make sure the voltage selector is set correctly.
- Are the + and – speaker cords short-circuited?
- Are you using the supplied speakers?
- Is anything blocking the ventilation holes on the rear of the system?

Check all the above items and fix any problems found. After I/⏻ indicator stops flashing, reconnect the power cord and turn on the system. If the indicator still flashes, or if the cause of the problem cannot be found even after checking all the above items, consult your nearest Sony dealer.

## General

---

### “- -: -” appears in the display.

- A power interruption has occurred. Set the clock (page 13) and timer settings (pages 35 and 36) again.

---

### The clock setting/radio presetting/timer is canceled.

- Redo the following:
  - “Setting the clock” (page 13)
  - “Presetting radio stations” (page 28)
  - “Falling asleep to music” and “Waking up to music” (page 35)
  - “Timer recording radio programs” (page 36)

---

### There is no sound.

- Press VOLUME +.
- Make sure the headphones are not connected.
- Check the speaker connections (page 10).
- There is no audio output during Rec Timer.
- The system is in pause mode or in slow-motion play mode. Press ▷ (or DVD ►|| on the unit) to return to Normal Play.
- Set “Dolby Digital” or “DTS” under “AV” to “PCM.”

---

### There is severe hum or noise.

- Move the system away from the source of noise.
- Connect the system to a different wall outlet.
- Install a noise filter (commercially available) to the power cord.

---

### The timer cannot be set.

- Set the clock again (page 13).

---

### The timer does not function.

- Check the timer setting and set the correct time (pages 35 and 36).
- Cancel the Sleep Timer function (page 35).

---

### The remote does not function.

- Remove the obstacle.
- Move the remote closer to the system.
- Point the remote at the system’s sensor.
- Replace the batteries (R6/size AA).
- Locate the system away from the fluorescent light.

---

### There is acoustic feedback.

- Reduce the volume.
- Move the microphone away from the speakers or change the direction of the microphone (CMT-SX2D Asian and Oceanian models only).

---

### The color irregularity on a TV screen persists.

- Turn off the TV set once, then turn it on after 15 to 30 minutes. If the color irregularity still persists, place the speakers farther away from the TV set.
- 

## Speakers

---

### Sound comes from one channel or unbalanced left and right volume.

- Check the speaker connection and speaker placement.
  - The source being played back is monaural.
- 

### Sound lacks bass.

- Check that the speaker's + and – jacks are connected correctly.
- 

## DVD/VIDEO CD/CD/MP3/JPEG player

---



### The disc tray does not open and "LOCKED" appears.

- Contact your Sony dealer or local authorized Sony service facility.
- 



### The disc tray does not close.

- Place the disc correctly.
  - Always close the tray by pressing  on the unit. Trying to press the tray closed with your fingers may cause problems with the player.
- 

### The disc does not eject.

- You cannot eject the disc during CD Synchro Recording. Press  to cancel the CD Synchro Recording, then press  on the unit to eject the disc.
  - Consult your nearest Sony dealer.
- 

### Play does not start.

- Open the disc tray and check whether a disc is loaded.
- Wipe the disc clean (page 50).
- Replace the disc.
- Place the disc that this system can play (page 6).
- Place the disc correctly.
- Place the disc in the tray with the label side up.
- Remove the disc and wipe away the moisture on the disc, then leave the system turned on for a few hours until the moisture evaporates.
- Press  (or DVD  on the unit) to start play.
- The region code on the DVD does not match the system.

---

### The sound skips.

- Wipe the disc clean (page 50).
  - Replace the disc.
  - Try moving the system to a place without vibration (e.g., on top of a stable stand).
  - Try moving the speakers away from the system, or placing them on separate stands. When you listen to a track with bass sounds at high volume, the speaker vibration may cause the sound to skip.
- 

### Play does not start from the first track.

- Press PLAY MODE repeatedly until both "PGM" and "SHUF" disappear to return to Normal Play.
  - Resume Play has been selected. Press  in stop mode, then start playback (page 15).
  - The title, DVD or PBC menu automatically appears on the TV screen.
- 

### Playback starts automatically.

- The DVD features an auto playback function.
- 

### Playback stops automatically.

- Some discs may contain an auto pause signal. While playing such a disc, the playback stops at the auto pause signal.
- 

### You cannot perform some functions such as Stop, Search, Slow-motion Play, Repeat Play, Shuffle Play or Program Play.

- Depending on the disc, you may not be able to do some of the operations above. Refer to the operating instructions supplied with the disc.
- 

### MP3 audio track cannot be played back.

- Recording was not performed according to the ISO9660 Level 1 or Level 2 format, or Joliet in the expansion format.
  - The MP3 audio track does not have the extension ".MP3".
  - The data is not stored in MP3 format.
  - Discs containing files other than MPEG1 Audio Layer-3 files cannot be played.
  - Set "Data CD Priority" under "AV" to "MP3" (page 23).
  - Playback is possible up to 16 levels.
  - The album contains more than 999 MP3 audio tracks.
- 

### MP3 audio tracks take longer to play back than others.

- After the system reads all tracks on the discs, playback may take more time than usual if:
  - the number of albums or tracks on the disc is very large.
  - the album and track organization structure is very complex.

---

**The JPEG image file cannot be played.**

- The data CD is not recorded in JPEG format that conforms to ISO9660 Level 1/Level 2 or Joliet.
- The JPEG image file does not have the extension “.JPG” or “.JPEG”.
- The data is not formatted in JPEG even though it has the extension “.JPG” or “.JPEG”.
- Set “Data CD Priority” under “AV” to “JPEG” (page 23).
- Playback is possible up to 16 levels.
- The album contains more than 999 JPEG image files.

---

**The sound loses stereo effect when you play a VIDEO CD or CD.**

- Press AUDIO repeatedly during playback to select “Stereo” (see “Changing the sound” (page 21)).
- Make sure the system is connected appropriately.

---

**The recording was not done properly when making a digital recording from the CD/DVD player of this system to an optional component connected to the DIGITAL OUT (OPTICAL) jack.**



- Audio data is output from the DIGITAL OUT (OPTICAL) jack without any sound processing, so that the audio data is output slightly ahead of the sound from the speakers. Therefore, start the optional component recording in advance when making a digital recording to a connected optional component (MD deck, etc.).

---

**Picture**

---

**There is no picture.**

- Press  (or DVD  on the unit).
- Check that the system is connected securely.
- The video cable is damaged. Replace it with a new one.
- Make sure you connect the system to the video input jack of your TV (page 10).
- Make sure you turn on the TV and operate the TV correctly.
- Make sure you select the video input on the TV so that you can view the pictures from the system.
- When you play a VIDEO CD, make sure you set the color system correctly, according to your TV (color) system (Asian and Oceanian models only).
- Make sure you connect the system and your TV using the video/SCART cable so that you can view the pictures.

- For European and Russian models, when connecting your TV and the  LINE-TV jack of this system using a SCART cable (not supplied), make sure that the VIDEO OUT SELECTOR is set to EURO AV (RGB signals are not output when the VIDEO OUT SELECTOR is set to COMPONENT). Also in this case set the system to interlace format (page 24). When connecting your TV and the COMPONENT VIDEO OUT jack of this system using a component cable (not supplied), make sure the VIDEO OUT SELECTOR is set to COMPONENT.
- For European and Russian models, turn off the system when switching the VIDEO OUT SELECTOR. The setting does not change while the system is on.
- Except for European and Russian models, when connecting your TV and the VIDEO OUT jack of this system using the video cable (supplied), set the system to interlace format (page 24).
- You have set progressive format but your TV cannot accept the signal in progressive format. In this case, return the setting to interlace format (default setting) (page 24).
- Even if your TV is compatible with progressive format (525p/625p) signals, the image may be affected when you set progressive format. In this case, return the setting to interlace format (default setting) (page 24).

---

**Picture noise appears.**

- Clean the disc.
- When you play a VIDEO CD, the color system is different. Set the color system to match your TV (page 23) (Asian and Oceanian models only).

---

**The aspect ratio of the screen cannot be changed even though you set “TV Type” under “AV” in the Setup Display when you play a wide picture.**

- The aspect ratio is fixed on your DVD.
- Depending on the TV, you may not change the aspect ratio.

---

**Messages do not appear on the screen in the language you want.**

- Select the language you want for the on-screen display in “OSD” under “Language” in the Setup Display (page 22).

---

**The language for the sound track cannot be changed.**

- Multilingual tracks are not recorded on the DVD being played.
- The DVD prohibits changing the language for the sound track.

---

**The subtitle language cannot be changed.**

- Multilingual subtitles are not recorded on the DVD being played.
- The DVD prohibits changing the subtitles.

---

**The subtitle cannot be turned off.**

- The DVD prohibits turning off subtitles.

---

**The angles cannot be changed.**

- Multi-angles are not recorded on the DVD being played.
  - The DVD prohibits changing the angles.
- 

## Tuner

---

**Severe hum or noise/stations cannot be received. (“TUNED” or “STEREO” flashes in the display)**

- Set the proper band and frequency (page 28).
- Connect the antenna properly (page 10).
- Find a place and an orientation that provide good reception, then set up the antenna again. If you cannot obtain good reception, we recommend you connect a commercially available external antenna.
- The supplied FM lead antenna receives signals along its entire length, so make sure you extend it fully.
- Locate the antennas as far away from the speaker cords as possible.
- Consult your nearest Sony dealer if the supplied AM antenna has come off the plastic stand.
- Try turning off surrounding electrical equipment.

---

**A stereo FM program cannot be received in stereo.**

- Press FM MODE repeatedly until “MONO” disappears.
- 

## Tape deck

---

**The tape does not record or play, or there is a decrease in sound level.**

- The heads are dirty. Clean them (page 50).
- The record/playback heads are magnetized. Demagnetize them (page 50).

---

**The tape does not erase completely.**

- The record/playback heads are magnetized. Demagnetize them (page 50).

---

**There is excessive wow or flutter, or the sound drops out.**

- The capstans or pinch rollers are dirty. Clean them (page 50).

---

**Noise increases or the high frequencies are erased.**

- The record/playback heads are magnetized. Demagnetize them (page 50).

---

**The tape does not record.**

- No cassette is loaded. Load a cassette.
- The tab has been removed from the cassette. Cover the broken tab with adhesive tape (page 50).
- The tape has wound to the end.
- Set “Dolby Digital” or “DTS” under “AV” to “PCM.”

---

**“TAPE ERR” appears in the display.**

- Press I/⏻ to turn off the system and remove any tapes from the cassette holder. Then disconnect the power cord and reconnect it. Then press I/⏻ to turn on the system. If “TAPE ERR” still appears, consult your nearest Sony dealer.
- 

## Optional components

---

**There is no sound.**

- Refer to General item “There is no sound.” (page 44) and check the condition of the system.
  - Connect the component properly (page 41) while checking:
    - if the cords are connected properly.
    - if the cord plugs are firmly inserted all the way.
  - Turn on the connected component.
  - Refer to the operating instructions supplied with the connected component and start playing.
-

**If the system still does not operate properly after performing the above measures, reset the system as follows:**

Use buttons on the unit for the operation.

- 1 Remove the disc if it is loaded.
- 2 Disconnect the power cord.
- 3 Reconnect the power cord.
- 4 Press I/⏻ to turn on the system.
- 5 Press DVD ►|| to switch the function to DVD and make sure that "NO DISC" is displayed.
- 6 Press ■, PLAY MODE and DVD ►|| at the same time.

The system is reset to the factory settings except for DVD settings. You should set the settings you made, such as the preset stations, clock, and timer.

**To return the DVD setup to the default settings\*, perform reset as follows:**

The operation can only be set using the TV screen.

- 1 Press ◻ DISPLAY in stop mode.
- 2 Press ◀ or ▶ repeatedly to select "Reset," then press ENTER.
- 3 Press ◀ or ▶ repeatedly to select "YES," then press ENTER.  
It takes a few seconds to complete. Do not press I/⏻ when resetting the system.

\* Except for Rating (Parental Control) settings

## Messages

One of the following messages may appear or flash in the display during operation.

### DVD/VIDEO CD/CD/MP3/JPEG

---

#### CAN'T PLAY

- A disc that cannot be played was inserted.
  - A disc with an unsupported Region code was inserted.
- 

#### NO DISC

There is no disc in the unit.

---

#### NOT IN USE

You pressed an invalid button.

---

### Tape

---

#### NO TAB

You cannot record the tape because the tab has been removed from the cassette.

---

#### NO TAPE

There is no tape in the tape deck.

---

#### TAPE ERR

A malfunction of the tape deck has occurred.

---



## Additional Information

### Precautions

#### On operating voltage

Before operating the system, check that the operating voltage of your system is identical with the voltage of your local power supply.

#### On safety

- The unit is not disconnected from the AC power source (mains) as long as it is connected to the wall outlet, even if the unit itself has been turned off.
- Unplug the system from the wall outlet (mains) if it is not to be used for an extended period of time. To disconnect the power cord (mains lead), pull it out by the plug. Never pull the cord itself.
- Should any solid object or liquid fall into the system, unplug the system and have it checked by qualified personnel before operating it any further.
- AC power cord must be changed only at the qualified service shop.

#### On placement

- Do not place the system in an inclined position.
- Do not place the system in locations where it is:
  - Extremely hot or cold
  - Dusty or dirty
  - Very humid
  - Subject to vibrations
  - Subject to direct sunlight.
- Use caution when placing the unit or speakers on surfaces that have been specially treated (with wax, oil, polish, etc.) as staining or discoloration of the surface may result.

#### On heat buildup

- Although the system heats up during operation, this is not a malfunction.
- Place the system in a location with adequate ventilation to prevent heat buildup in the system.
- If you continuously use this system at a high volume, the cabinet temperature of the top, side and bottom rises considerably. To avoid burning yourself, do not touch the cabinet.
- To prevent a malfunction, do not cover the ventilation hole for the cooling fan.

#### In case color irregularity is observed on nearby a TV screen

With the magnetically shielded type of speaker system, the speakers can be installed near a TV set. However, color irregularity may still be observed on the TV screen depending on the type of your TV set.

#### If color irregularity is observed...

Turn off the TV set once, then turn it on after 15 to 30 minutes.

#### If color irregularity is observed again...

Place the speakers farther away from the TV set.

#### IMPORTANT NOTICE

Caution: This system is capable of holding a still video image or on-screen display image on your television screen indefinitely. If you leave the still video image or on-screen display image displayed on your TV for an extended period of time you risk permanent damage to your television screen. Projection televisions are especially susceptible to this.

#### On operation

- If the system is brought directly from a cold to a warm location, or is placed in a very damp room, moisture may condense on the lens inside the CD/DVD player. Should this occur, the system will not operate properly. Remove the disc and leave the system turned on for about an hour until the moisture evaporates.
- When you move the system, take out any disc.

If you have any questions or problems concerning your system, please consult your nearest Sony dealer.

## Notes on discs

- Before playing, clean the disc with a cleaning cloth. Wipe the disc from the center out.
- Do not use solvents such as benzene, thinner, commercially available cleaners or anti-static spray intended for vinyl LPs.
- Do not expose the disc to direct sunlight or heat sources such as hot air ducts, nor leave it in a car parked in direct sunlight.
- Do not use discs encircled with a protection ring. This may cause a malfunction to the system.
- When using discs that have glue or similar tacky substance on the label side of the disc or that used a special ink when the label was printed, there is a chance that the disc or label may become attached to parts inside this unit. When this occurs, it may not be possible to remove the disc, and may also cause this unit to malfunction. Be sure to check that the label side of the disc is not sticky before using.  
The following types of disc should not be used:
  - Rental or used discs with attached seals where the glue extends beyond the seal. The perimeter of the seal on the disc is tacky.
  - Discs that have labels printed using a special ink that feels tacky when touched.

## Cleaning the cabinet

Clean the cabinet, panel and controls with a soft cloth slightly moistened with mild detergent solution. Do not use any type of abrasive pad, scouring powder or solvent such as thinner, benzene or alcohol.

## To save a tape permanently

To prevent a tape from being accidentally recorded over, break off the cassette tab from side A or B as illustrated.

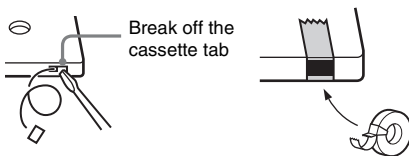

If you later want to reuse the tape for recording, cover the broken tab with adhesive tape.

## Before placing a cassette in the tape deck

Take up any slack in the tape. Otherwise, the tape may get entangled in the parts of the tape deck and become damaged.

## When using a tape longer than 90 minutes

The tape is very elastic. Do not change the tape operations such as play, stop, and fast-winding frequently. The tape may get entangled in the tape deck.

## Cleaning the tape heads

Clean the tape heads after every 10 hours of use. Be sure to clean the tape heads before you start an important recording or after playing an old tape. Use a separately sold dry-type or wet-type cleaning cassette. For details, refer to the instructions of the cleaning cassette.

## Demagnetizing the tape heads

Demagnetize the tape heads and the metal parts that have contact with the tape after every 20 to 30 hours of use with a separately sold demagnetizing cassette. For details, refer to the instructions of the demagnetizing cassette.

# Specifications

## Amplifier section

### AUDIO POWER SPECIFICATIONS (CMT-DX2D USA model only)

#### CMT-DX2D

#### POWER OUTPUT AND TOTAL HARMONIC DISTORTION:

With 6 ohm loads, both channels driven, from 120 – 10,000 Hz: rated 50 watts per channel minimum RMS power, with no more than 10% total harmonic distortion from 250 milliwatts to rated output.

#### North American model:

##### CMT-DX2D

Continuous RMS power output (reference):  
50 + 50 watts (6 ohms at 1 kHz, 10% THD)  
Total harmonic distortion less than 0.07% (6 ohms at 1 kHz, 25 W)

#### European and Russian models:

##### CMT-DX2D

DIN power output (rated): 40 + 40 watts (6 ohms at 1 kHz, DIN)  
Continuous RMS power output (reference):  
50 + 50 watts (6 ohms at 1 kHz, 10% THD)  
Music power output (reference):  
100 + 100 watts (6 ohms at 1 kHz, 10% THD)

#### Korean and Thai models:

##### CMT-DX2D/SX2D

The following measured at AC 220 V, 60 Hz  
DIN power output (rated): 35 + 35 watts  
(6 ohms at 1 kHz, DIN)  
Continuous RMS power output (reference):  
45 + 45 watts  
(6 ohms at 1 kHz, 10% THD)

#### Other models:

##### CMT-DX2D/SX2D

The following measured at AC 120 V, 240 V, 50/60 Hz  
DIN power output (rated): 40 + 40 watts

(6 ohms at 1 kHz, DIN)

Continuous RMS power output (reference):

50 + 50 watts

(6 ohms at 1 kHz, 10% THD)

#### Inputs

TV IN (phono jacks): voltage 1 V,  
impedance 47 kilohms

MIC (phone jack) (CMT-SX2D Asian and Oceanian models only):  
sensitivity 1 mV,  
impedance 10 kilohms

#### Outputs

VIDEO OUT (phono jack) (except for European and Russian models):  
max. output level  
1 Vp-p, unbalanced, Sync negative, load impedance 75 ohms

LINE-TV (European and Russian models only):  
max. output level 1 Vp-p, unbalanced, Sync negative, load impedance 75 ohms

#### COMPONENT VIDEO OUT:

Y: 1 Vp-p, 75 ohms  
Pb, Pr: 0.7 Vp-p, 75 ohms

DIGITAL OUT (OPTICAL) (Square optical connector jack, rear panel)

Wavelength 660 nm

PHONES (stereo mini jack):  
accepts headphones of 8 ohms or more

SPEAKER:  
accepts impedance of 6 ohms

## Disc player section

System Compact disc and digital audio and video system

Laser Semiconductor laser  
(DVD:  $\lambda=650$  nm,  
CD:  $\lambda=790$  nm)

Emission duration: continuous

Frequency response DVD (PCM 48 kHz):  
2 Hz – 22 kHz ( $\pm 1$  dB)  
CD: 2 Hz – 20 kHz ( $\pm 1$  dB)

#### Video color system format

Pan-American models:  
NTSC

European and Russian models: PAL

Other models: NTSC, PAL

## Tape deck section

Recording system	4-track 2-channel stereo
Frequency response	40 – 13,000 Hz, using Sony TYPE I cassette
Wow and flutter	±0.15% W.Peak (IEC) 0.1% W.RMS (NAB) ±0.2% W.Peak (DIN)

## Tuner section

FM stereo, FM/AM superheterodyne tuner

### FM tuner section

Tuning range	87.5 – 108.0 MHz (50 kHz step)
Antenna	FM lead antenna
Antenna terminals	75 ohms unbalanced
Intermediate frequency	10.7 MHz
AM tuner section	
Tuning range	
Pan-American models:	530 – 1,710 kHz (with the tuning interval set at 10 kHz) 531 – 1,710 kHz (with the tuning interval set at 9 kHz)

European and Russian models:

531 – 1,602 kHz  
(with the tuning interval  
set at 9 kHz)

Other models:

530 – 1,710 kHz  
(with the tuning interval  
set at 10 kHz)  
531 – 1,602 kHz  
(with the tuning interval  
set at 9 kHz)

Antenna	AM loop antenna
Antenna terminals	External antenna terminal
Intermediate frequency	450 kHz

## Speaker

Speaker system	2-way, bass-reflex type, magnetically shielded type
Speaker units	
Woofer:	12 cm, cone type
Tweeter:	4 cm, cone type
Nominal impedance	6 ohms
Dimensions (w/h/d)	Approx. 170 × 250 × 220 mm
Mass	Approx. 3.0 kg net per speaker

## General

Power requirements

North American model: 120 V AC, 60 Hz

European and Russian models:

230 V AC, 50/60 Hz

Australian model: 230 – 240 V AC, 50/60 Hz

Korean model: 220 V AC, 60 Hz

Thai model: 220 V AC, 50/60 Hz

Taiwan model: 120 V AC, 50/60 Hz

Other models: 110 – 120 V, 220 – 240 V  
AC, 50/60 Hz  
Adjustable with voltage  
selector

Power consumption

North American model: 110 watts

European and Russian models:

110 watts

0.3 watts (in Power Saving  
Mode)

Australian, Korean and Thai models:

110 watts

Other models: 120 watts

Dimensions (w/h/d) (excl. speakers)

Pan-American, European, Russian, Australian and

Korean models: Approx. 190 × 250 ×  
301 mm

Other models: Approx. 190 × 250 ×  
310 mm

Mass (excl. speakers) Approx. 5.9 kg

Supplied accessories: Remote Commander (1)  
R6 (size AA) batteries (2)  
AM loop antenna (1)  
FM lead antenna (1)  
Video cable (1) (except for  
European and Russian  
models)  
Speaker pads (8)

Design and specifications are subject to change  
without notice.

# Glossary

## Album

Section of a music piece on a data CD containing MP3 audio tracks or JPEG image files.

## Auto Pause

An automatical pauses according to the signal encoded on the disc while playing a VIDEO CD. If the CD/DVD player does not resume play for a long time, press  $\triangleright$  (or DVD  $\blacktriangleright \parallel$  on the unit) to resume play manually.

## Chapter

Sections of a picture or a music piece on a DVD that are smaller than titles. A title is composed of several chapters. Each chapter is assigned a chapter number enabling you to locate the chapter you want.

## Dolby Digital

This sound format for movie theaters is more advanced than Dolby Surround Pro Logic. In this format, the surround speakers output stereo sound with an expanded frequency range and a subwoofer channel for deep bass is independently provided. This format is also called "5.1" because the subwoofer channel is counted as 0.1 channel (since it functions only when a deep bass effect is needed). All six channels in this format are recorded separately to realize superior channel separation. Furthermore, since all the signals are processed digitally, less signal degradation occurs.

## DTS

Digital audio compression technology that the Digital Theater Systems, Inc. developed. This technology conforms to 5.1-channel surround. The surround channel is stereo and there is discrete sub woofer channel in this format. DTS provides the same 5.1 discrete channels of high quality digital audio. The good channel separation is realized because the all channel data is recorded discrete and processed in digital.

## DVD

A disc that contains up to 8 hours of moving pictures even though its diameter is the same as a CD.

The data capacity of a single-layer and single-sided DVD, at 4.7 GB (Giga Byte), is 7 times that of a CD. Furthermore, the data capacity of a dual-layer and single-sided DVD is 8.5 GB, a single-layer and double-sided DVD 9.4 GB, and a dual-layer and double-sided DVD 17 GB.

The picture data uses the MPEG 2 format, one of the worldwide standards of digital compression technology. The picture data is compressed to about 1/40 of its original size. The DVD also uses the variable rate coding technology that changes the data to be allocated according to the status of the picture.

The audio data is recorded in Dolby Digital as well as in PCM, allowing you to enjoy more realistic audio presence.

Furthermore, various advanced functions such as the multi-angle, multilingual, and Parental Control functions are provided with the DVD.

## DVD-RW

A DVD-RW is a recordable and rewritable disc that is the same size as a DVD VIDEO. The DVD-RW has two different modes: VR mode and Video mode. DVD-RWs created in Video mode have the same format as a DVD VIDEO, while discs created in VR (Video Recording) mode allow the contents to be programmed or edited.

## DVD+RW

A DVD+RW (plus RW) is a recordable and rewritable disc. DVD+RWs use a recording format that is comparable to the DVD VIDEO format.

## File

Section of a picture on a data CD containing JPEG image files.

## Film based software, Video based software

DVDs can be classified as Film based or Video based software. Film based DVDs contain the same images (24 frames per second) that are shown at movie theaters. Video based DVDs, such as television dramas or sit-coms, displays images at 30 frames (or 60 fields) per second.

**Index (CD) / Video Index (VIDEO CD)**

A number that divides a track into sections to easily locate the point you want on a VIDEO CD or a CD. Depending on the disc, no indexes may be recorded.

**Interlace format (Interlaced scanning)**

Interlace format shows every other line of an image as a single “field” and is the standard method for displaying images on television. The even number field shows the even numbered lines of an image, and the odd numbered field shows the odd numbered lines of an image.

**Menu Playback**

Playback using the menu screens recorded on VIDEO CDs with PBC functions. You can enjoy simple interactive software using the menu playback function.

**Multi-angle function**

Various angles, or viewpoints of the video camera, for a scene are recorded on some DVDs.

**Multilingual function**

Several languages for the sound or subtitles in a picture are recorded on some DVDs.

**Multi Session**

This is a recording method that enables adding of data using the Track-At-Once method. Conventional CDs begin at a CD control area called the Lead-in and end at an area called Lead-out. A Multi Session CD is a CD having multiple sessions, with each segment from Lead-in to Lead-out regarded as a single session. CD-Extra: This format records audio (audio CD data) on the tracks in session 1 and data on the tracks in session 2.

**Parental Control**

A function of the DVD to limit playback of the disc by the age of the users according to the limitation level in each country/region. The limitation varies from disc to disc; when it is activated, playback is completely prohibited, violent scenes are skipped or replaced with other scenes and so on.

**Playback Control (PBC)**

Signals encoded on VIDEO CDs (Version 2.0) to control playback. By using menu screens recorded on VIDEO CDs with PBC functions, you can enjoy playing simple interactive programs, programs with search functions, and so on.

This system conforms to Ver. 1.1 and Ver. 2.0 of VIDEO CD standards. You can enjoy two kinds of playback depending on the disc type.

**VIDEO CDs without PBC functions (Ver. 1.1 discs)**

Enjoy video playback (moving pictures) as well as music.

**VIDEO CDs with PBC functions (Ver. 2.0 discs)**

Play interactive software using menu screens displayed on the TV screen (PBC Playback), in addition to the video playback functions of Ver. 1.1 discs. Moreover, you can play high-resolution still pictures, if they are included on the disc.

**Progressive format (sequential scanning)**

In contrast to the Interlace format, the progressive format can reproduce 50 to 60 frames per second by reproducing all scanning lines (525 lines for the NTSC system, 625 lines for the PAL system). The overall picture quality increases and still images, text, and horizontal lines appear sharper. This format is compatible with the 525 or 625 progressive format.

**Region Code**

This system is used to protect copyrights. A region number is allocated on each DVD system or DVD disc according to the sales region. Each region code is shown on the system as well as on the disc packaging. The system can play the discs that match its region code. The system can also play discs with the “” mark. Even when the region code is not shown on the DVD, the region limit may still be activated.

## Title

The longest sections of a picture or a music piece on a DVD; a movie, etc., for a picture piece on video software; or an album, etc., for a music piece on audio software. Each title is assigned a title number enabling you to locate the title you want.

## Track

Sections of a picture or a music piece on a CD, VIDEO CD, MP3 or JPEG. Each track is assigned a track number enabling you to locate the track you want.

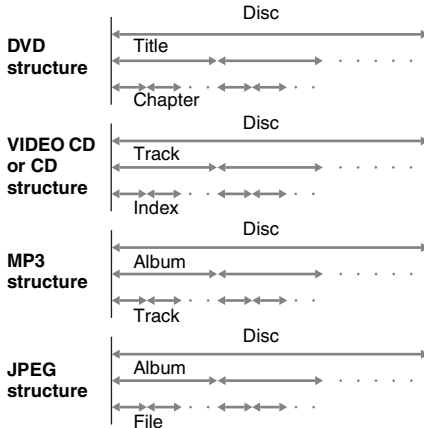

## VIDEO CD

A compact disc that contains moving pictures. The picture data uses the MPEG 1 format, one of the worldwide standards for digital compression technology. The picture data is compressed to about 1/140 of its original size. Consequently, a 12 cm VIDEO CD can contain up to 74 minutes of moving pictures.

VIDEO CDs also contain compact audio data. Sounds outside the range of human hearing are compressed while the sounds we can hear are not compressed. VIDEO CDs can hold 6 times the audio information of conventional audio CDs.

There are 2 versions of VIDEO CDs.

- Version 1.1: You can play only moving pictures and sounds.
- Version 2.0: You can play high-resolution still pictures and enjoy PBC functions.

This system conforms to both versions.

# List of button locations and reference pages

## How to use this page

Use this page to find the location of buttons and other parts of the system that are mentioned in the text.

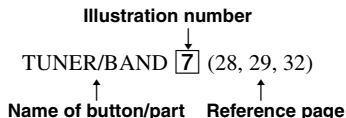

## Main unit

### ALPHABETICAL ORDER

#### A - O

- Cassette compartment **16** (31)
- CD SYNC **10** (31)
- Disc tray **5** (14)
- DISPLAY **9** (30, 37, 38, 39)
- Display window **3**
- MIC jack\* **15** (33)
- MIC LEVEL\* **14** (33)

#### P - Z

- PHONES jack **18**
- PLAY MODE **23** (15, 19, 48)
- PRESET EQ **22** (33)
- PROGRESSIVE **21** (24)
- Remote sensor **4**
- TUNER/BAND **7** (28, 29, 32)
- TUNING +/- **12** (28, 30)
- TV **20** (32, 42)
- VOLUME control **17** (42)

### BUTTON DESCRIPTIONS

- I/⏻ (on/standby) **1** (11, 48)
- TAPE ▶ (play) **2** (31)
- DVD ▶|| (play/pause) **6** (14, 32, 43, 48)
- ▲ (open/close) **8** (14)
- REC PAUSE/START (record) **11** (31, 34)
- ◀/▶ (rewind/fast forward) **12** (15, 31)
- ◀◀/▶▶ (go back/forward) **12** (15, 31)
- ▲ PUSH OPEN/CLOSE (eject) **13** (31)
- (stop) **19** (12, 15, 24, 29, 31, 32, 34, 43, 48)

\* CMT-SX2D Asian and Oceanian models only

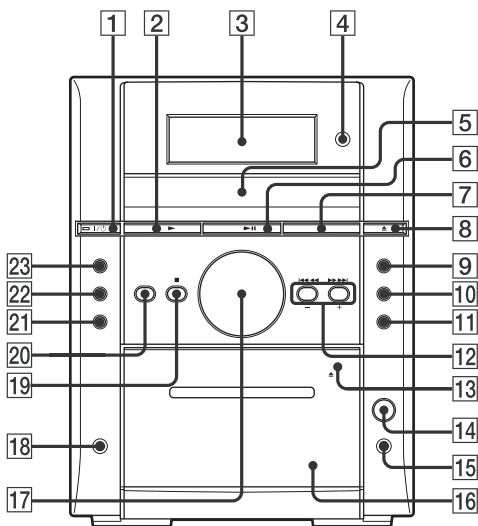



# Remote control

## ALPHABETICAL ORDER

### A - O

- ANGLE **5** (22)
- AUDIO **4** (21, 33)
- CLEAR **34** (19, 20, 25)
- CLOCK/TIMER SELECT **20**  
(36, 37)
- CLOCK/TIMER SET **20** (13, 35, 36)
- DIMMER **37** (37)
- DISPLAY **17** (30, 37, 38, 39)
- DVD **36** (12, 13, 14, 17, 19, 24, 26, 31, 43)
- ENTER **12** **25** (13, 16, 17, 19, 20, 22, 23, 25, 28, 35, 36, 42, 48)
- FM MODE **35** (30)
- FUNCTION +/- **2** (12, 13, 14, 17, 19, 24, 26, 31, 43)
- MENU **6** (16, 17)
- MUTING **26** (15, 30, 31)
- Number buttons\* **14** (16, 17, 19, 20, 25, 40)

### P - Z

- PLAY MODE **15** (15, 19)
- PRESET + **28** (28, 29)
- PRESET - **32** (28, 29)
- PRESET EQ **24** (33)
- REPEAT **35** (18)
- SEARCH **3** (20)
- SLEEP **18** (35)
- SUBTITLE **23** (22)
- TAPE **16** (31)
- THEATRE SYNC **19** (40)
- TOP MENU **13** (16)
- TUNER/BAND **21** (28, 29)
- TUNER MEMORY **22** (28)
- TUNING + **9** (28, 30)
- TUNING - **11** (28, 30)
- TV **30** (40)
- TV CH + **28** (40)
- TV CH - **32** (40)
- TV/VIDEO **18** (40)
- TV VOL +/-\* **7** (40)
- VOLUME +/-\* **7** (15, 30, 31, 35)

## BUTTON DESCRIPTIONS

- I/⏻ (on/standby) **1** (11, 35, 48)
- TV I/⏻ **1** (40)
- ◀◀ SLOW/SLOW ▶▶ **8** (15)
- ▶▶ (fast forward) **9** (15, 31)
- ⏸ (pause) **10** (15)
- ◀◀ (rewind) **11** (15, 31)
- ⬆/⬇/⬅/➡ **12** (13, 15, 22, 42, 48)
- ☰ DISPLAY **27** (13, 22, 42, 48)
- ▶▶ (forward) **28** (13, 15, 31, 35)
- (stop) **29** (12, 15, 24, 31, 32, 34, 43)
- ▷ (play)\* **31** (14, 31, 43)
- ◀◀ (go back) **32** (13, 15, 31, 35)
- ↶ RETURN **33** (17)
- /- **34**

\* The ▷, number 5 and VOLUME + (TV VOL +) buttons have tactile dots. Use the tactile dots as references when operating the system.

