

# FRIGIDAIRE

All about the

# Use & Care

of your Electric Range

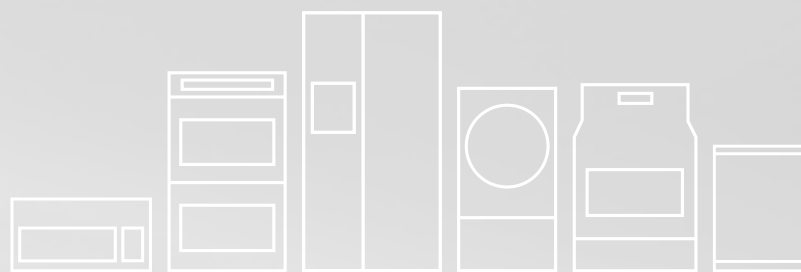

## TABLE OF CONTENTS

Important Safety Instructions .....	3-5	Setting Oven Controls .....	19-32
Features at a Glance .....	6	Keep Warm Drawer .....	33-34
Before Setting Oven Controls .....	7-9	Self-cleaning .....	35-37
Before Setting Surface Controls .....	10-12	Care & Cleaning .....	38-41
Setting Surface Controls .....	13-16	Before You Call .....	42-46
Oven Control Functions (PT1000 WD) .....	18	Major Appliance Warranty .....	back cover

# PRODUCT RECORD AND REGISTRATION

## Contents

<b>Important Safety Instructions .....</b>	<b>3-5</b>
<b>Features at a Glance .....</b>	<b>6</b>
<b>Before Setting Oven Controls .....</b>	<b>7-9</b>
Removing, replacing & arranging the oven racks .....	7
Effortless™ Oven Rack system and assembly .....	9
<b>Before Setting Surface Controls .....</b>	<b>10-12</b>
Cookware material types for the cooktop .....	10
Cooktop display windows .....	12
<b>Setting Surface Controls .....</b>	<b>13-17</b>
Single surface elements .....	13
Bridge element .....	14
Triple element .....	15
Keep warm zone .....	16
Home canning .....	17
<b>Oven Controls Functions .....</b>	<b>18</b>
<b>Setting Oven Controls .....</b>	<b>19-32</b>
Setting the clock .....	19
Changing between 6-Hour Energy Saving feature or continuous bake setting .....	19
Setting 12 or 24 hour display modes .....	19
Changing oven temperature display mode .....	20
Setting for audible or silent keypad operation .....	20
Setting lock .....	20
Timer .....	21
Add a minute .....	21
Powerplus preheat .....	21
Bake .....	22
Bake time .....	22
Delay start .....	23
Convect bake .....	24
Convect roast .....	24
Convect broil (some models) .....	25
Convect convert .....	25
Broil .....	26
Slow cook .....	27
Setting pizza feature .....	28
Setting keep warm .....	28
Setting my favorite .....	29
Adjusting oven temperature .....	30
Restoring to factory default settings .....	30
Operating the oven light .....	30
Setting the Sabbath feature .....	31-32
<b>Keep Warm Drawer .....</b>	<b>33-34</b>
<b>Self-Cleaning .....</b>	<b>35-37</b>
<b>Care &amp; Cleaning .....</b>	<b>38-41</b>
Cleaning recommendation table .....	38
Cooktop maintenance and cleaning .....	39-40
Replacing the oven light .....	40
Removing & replacing oven door .....	41
<b>Before You Call - Solutions to common problems ...</b>	<b>42-46</b>
<b>Appliance Warranty .....</b>	<b>back cover</b>

Thank you for choosing **Frigidaire**.

This Use & Care Guide is part of our commitment to customer satisfaction and product quality throughout the service life of your new appliance. We view your purchase as the beginning of a relationship. To ensure our ability to continue serving you, please use this page to record important product information.

## Need help??

**Visit the Frigidaire web site at [www.frigidaire.com](http://www.frigidaire.com)**

Before you call for service, there are a few things you can do to help us serve you better.

**Read this Use & Care manual.**

It contains instructions to help you use and maintain your range properly.

**If you received a damaged range ...**

immediately contact the dealer (or builder) that sold you the range.

**Save time and money.**

Review the "Before You Call" checklist. This section helps step you through some common problems that might occur. If you do need service, help is only a phone call away. Call Frigidaire Customer Services at **1-800-944-9044**.

## Product Registration

Registering your product with Frigidaire enhances our ability to serve you. You can register online at **[www.frigidaire.com](http://www.frigidaire.com)** or by dropping your Product Registration Card in the mail.

## Serial plate location

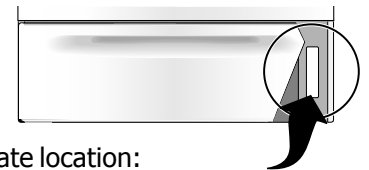

Serial plate location:  
open storage drawer (some models) or  
keep warm drawer (some models).

## Record model & serial numbers here

\_\_\_\_\_  
Purchase date

\_\_\_\_\_  
Model number

\_\_\_\_\_  
Serial number

# IMPORTANT SAFETY INSTRUCTIONS

## Read all instructions before using this appliance.

Do not attempt to install or operate your appliance until you have read the safety precautions in this manual. Safety items throughout this manual are labeled with a WARNING or CAUTION statement based on the risk type.

Ask your dealer to recommend a qualified technician and an authorized repair service. Know how to disconnect the power to the range at the circuit breaker or fuse box in case of an emergency.

### Definitions

**!** This is the safety alert symbol. It is used to alert you to potential personal injury hazards. Obey all safety messages that follow this symbol to avoid possible injury or death.

#### **!** WARNING

**WARNING** indicates a potentially hazardous situation which, if not avoided, may result in death or serious injury.

#### **!** CAUTION

**CAUTION** indicates a potentially hazardous situation which, if not avoided, may result in minor or moderate injury.

#### **➔** IMPORTANT

**IMPORTANT** indicates installation, operation, maintenance or valuable information that is not hazard related.

## Important Safety Instructions

- **Remove all tape and packaging before using the range.** Destroy the carton and plastic bags after unpacking the range. Never allow children to play with packaging material.
- **Proper installation—Be sure your appliance is properly installed and grounded by a qualified technician in accordance with the National Electrical Code ANSI/NFPA No. 70 latest edition and local electrical code requirements.** Install only per installation instructions provided in the literature package for this range.
- **User servicing—Do not repair or replace any part of the appliance unless specifically recommended in the manuals.** All other servicing should be done only by a qualified technician. This may reduce the risk of personal injury and damage to the range.

#### **!** WARNING

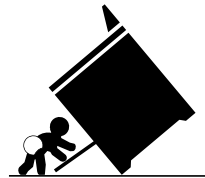

#### **Tip Over Hazard**

- **A child or adult can tip the range and be killed.**
- **Verify the anti-tip device has been installed to floor or wall.**
- **Ensure the anti-tip device is re-engaged when the range is moved to floor or wall.**
- **Do not operate the range without the anti-tip device in place and engaged.**
- **Failure to follow these instructions can result in death or serious burns to children and adults.**

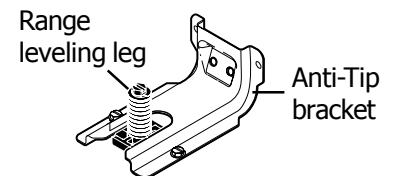

To check if the anti-tip bracket is installed properly, use both arms and grasp the rear edge of range back. Carefully attempt to tilt range forward. When properly installed, the range should not tilt forward.

Refer to the anti-tip bracket **installation instructions** supplied with your range for proper installation.

#### **!** WARNING

- **Stepping, leaning or sitting on the door or drawers of a range can result in serious injuries and also cause damage to the appliance.** DO NOT allow children to climb or play around the range. The weight of a child on an open oven door may cause the range to tip, resulting in serious burns or other injury.
- **DO NOT LEAVE CHILDREN ALONE—to avoid injuries or burns children should not be left alone or unattended in the area where the range is in use.** They should never be allowed to sit or stand on any part of the range including the storage drawer, lower broiler drawer, lower oven or warmer drawer.
- **To avoid a possible fire hazard, never use your appliance for warming or heating the room.**

Save these instructions for future reference.

# IMPORTANT SAFETY INSTRUCTIONS

## WARNING

- **Storage in or on appliance — to avoid a fire hazard, flammable materials should not be stored in an oven, near surface units or in the storage drawer, warmer drawer or lower oven.** This includes paper, plastic and cloth items, such as cookbooks, plasticware and towels, as well as flammable liquids. Do not store explosives, such as aerosol cans, on or near the range.
- **Protective liners**—Do not use aluminum foil to line the oven bottom. Only use aluminum foil as recommended in this manual. Improper installation of these liners may result in risk of electric shock, or fire.

## CAUTION

- **Do not store items of interest to children in the cabinets above a range or on the backguard of the range.** Children climbing on the range to reach items could be seriously injured.
- **Do not touch surface heating units or surface cooking elements, areas near these units or elements, or interior surfaces of oven.** Both surface heating and oven heating elements may be hot even though they are dark in color. Areas near surface cooking units may become hot enough to cause burns. During and after use, do not touch, or let clothing or other flammable materials touch these areas until they have had sufficient time to cool. Among these areas are the cooktop, surfaces facing the cooktop, the oven vent openings and surfaces near these openings, oven door and oven door window.
- **Wear proper apparel — loose-fitting or hanging garments should never be worn while using the appliance.** Do not let clothing or other flammable materials contact hot surfaces.
- **Do not use water or flour on grease fires — flour may be explosive. Smother the fire with a pan lid, or use baking soda, a dry chemical or foam-type extinguisher.**
- **When heating fat or grease, watch it closely.** Fat or grease may catch fire if allowed to become too hot.
- **Use dry potholders — moist or damp potholders on hot surfaces may result in burns from steam.** Do not let potholders touch hot heating elements. Do not use a towel or other bulky cloth instead of a potholder.
- **Do not heat unopened food containers - buildup of pressure may cause container to burst and result in injury.**

## IMPORTANT

**Do not attempt to operate the range during a power failure.** If the power fails, always turn off the range. If the range is not turned off and the power resumes, the range will begin to operate again. Once the power resumes, reset the clock and oven function.

- Be sure to always have an appropriate foam-type **fire extinguisher** available, visible and easily accessible located near the appliance.
- **Never modify or alter the construction of a range by removing the leveling legs, panels, wire covers, anti-tip bracket/screws, or any other part of the range.**
- **Remove the oven door from any unused range if it is to be stored or discarded.**

## IMPORTANT INSTRUCTIONS FOR USING YOUR OVEN

- **Use care when opening oven door , lower oven door or warmer drawer** (if equipped)—Stand to the side of the range when opening the door of a hot oven. Let hot air or steam escape before you remove or replace food in the oven.
- **Keep oven vent ducts unobstructed.** The oven vent is located under the left rear surface element if your model is equipped with coil elements. The oven vent is located below the backguard for models equipped with ceramic-glass cook tops. Touching the surfaces in this area when the oven is operating may cause severe burns. Also, do not place plastic or heat-sensitive items on or near the oven vent. These items could melt or ignite.
- **Placement of interior oven racks.** Always place oven racks in desired location while oven is cool. If rack must be moved while oven is hot use extreme caution. Use potholders and grasp the rack with both hands to reposition. Do not let potholders contact the hot heating elements in the oven. Remove all utensils from the rack before moving.
- **Do not use the broiler pan without its insert.** The broiler pan and its insert allow dripping fat to drain and be kept away from the high heat of the broiler. **Do not cover the broiler insert with aluminum foil. Exposed fat and grease could ignite.**

# IMPORTANT SAFETY INSTRUCTIONS

## SELF-CLEANING OVENS

### WARNING

- **Do not touch** the oven during the self-clean cycle.
  - Keep children away from oven during self-clean cycle.
  - Failure to follow these instructions can result in burns.
- **Clean in the self-cleaning cycle only the parts listed in this Use & Care Manual.** Before self-cleaning the oven, remove the broiler pan and any utensils or foods from the oven.
  - **Do Not Use Oven Cleaners**—No commercial oven cleaner or oven liner protective coating of any kind should be used in or around any part of the oven.
  - **Do Not Clean Door Gasket**—The door gasket is essential for a good seal. Care should be taken not to rub, damage or move the gasket.
  - The health of some birds is extremely sensitive to the fumes given off during the self-cleaning cycle of any range. Move birds to another well-ventilated room.

## IMPORTANT INSTRUCTIONS FOR CLEANING YOUR RANGE

- **Clean the range regularly to keep all parts free of grease that could catch fire.** Pay particular attention to the area around each surface element. Do not allow grease to accumulate.
- **Kitchen cleaners and aerosols—Always follow the manufacturer's recommended directions for use.** Be aware that excess residue from cleaners and aerosols may ignite causing damage and injury.
- **Clean ventilating hoods frequently—Grease should not be allowed to accumulate on the hood or filter.** Follow the manufacturer's instructions for cleaning hoods.

## FOR CERAMIC-GLASS COOK TOP MODELS

- **Do not cook on broken cook top**—If cook top should break, cleaning solutions and spillovers may penetrate the broken cook top and create a risk of electric shock. Contact a qualified technician immediately.
- **Clean cook top with caution**—If a wet sponge or cloth is used to wipe spills on a hot cooking area, be careful to avoid a steam burn. Some cleaners can produce noxious fumes if applied to a hot surface.

## IMPORTANT INSTRUCTIONS FOR USING YOUR COOKTOP

- **Know which knob controls each surface heating unit.** Place a pan of food on the unit before turning it on, and turn the unit off before removing the pan.
- **Use proper pan size**—This appliance is equipped with one or more surface units of different sizes. Select utensils having flat bottoms large enough to cover the surface unit heating element. The use of undersized utensils will expose a portion of the heating element to direct contact and may result in ignition of clothing. Proper relationship of utensil to element will also improve efficiency.
- **Utensil handles should be turned inward and not extend over adjacent surface elements**—To reduce the risk of burns, ignition of flammable materials, and spillage due to unintentional contact with the utensil, the handle of the utensil should be positioned so that it is turned inward, and does not extend over adjacent surface units.
- **Never leave surface elements unattended at high heat settings**—Boilovers cause smoking and greasy spillovers that may ignite, or a pan that has boiled dry may melt.
- **Do not immerse or soak removable heating elements**—Heating elements should never be immersed in water. Heating elements clean themselves during normal operation.
- **Glazed cooking utensils**—Only certain types of glass, glass/ceramic, ceramic, earthenware, or other glazed utensils are suitable for cook top service without breaking due to the sudden change in temperature. Check the manufacturer's recommendations for cook top use.
- **When flaming foods under a ventilating hood, turn the fan on.**

### Important Safety Notice

The California Safe Drinking Water and Toxic Enforcement Act requires the Governor of California to publish a list of substances known to the state to cause cancer, birth defects or other reproductive harm, and requires businesses to warn customers of potential exposure to such substances.

## FEATURES AT A GLANCE

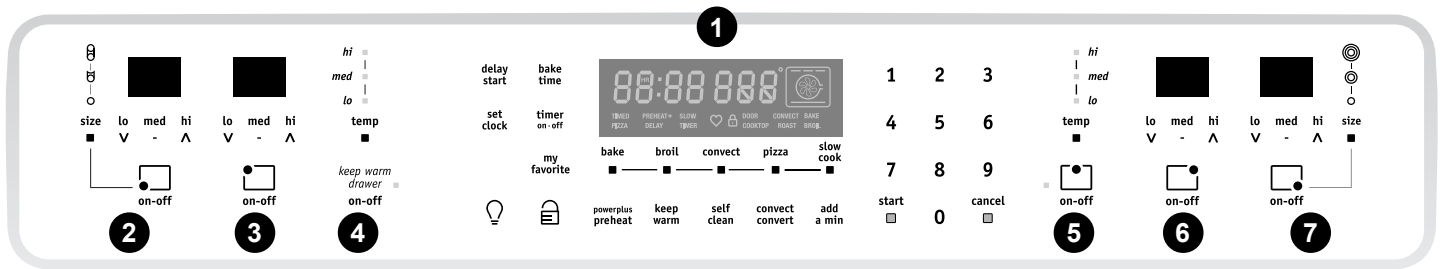

### Your electric range features include:

1. Electronic oven control with kitchen timer.
2. Left front single and bridge element control.
3. Left rear single radiant element control.
4. Keep warm drawer control & indicator lights (some models).
5. Keep warm zone radiant element control & indicator (some models).
6. Right rear single radiant element control.
7. Right front triple radiant element control.
8. Easy to clean upswept cooktop.
9. Automatic oven door light switch.
10. Self-clean door latch.
11. Oven interior halogen light with removable protective shield.
12. Self-cleaning oven interior.
13. Dual convection fans & cover.
14. Adjustable interior oven rack(s) and Effortless Oven Rack™ system (not shown-some models).
15. Large full width 1-piece oven door handle.
16. Full width oven door with window.
17. Storage drawer with integrated drawer handle (some models).
18. Keep warm drawer (some models).
19. Large full width 1-piece keep warm drawer handle (some models).
20. Leveling legs and **anti-tip** bracket (included).
21. Ceramic smoothtop (styles and color will vary by model).
22. **Space wise** bridge cooking zone.
23. Single radiant element (when not set for bridge).
24. Bridge portion of element.
25. **Keep warm zone** radiant element.
26. Single radiant element.
27. **Powerplus boil** triple radiant element.
28. Keep warm drawer rack (some models).
29. Broil pan insert (some models).
30. Broil pan (some models).

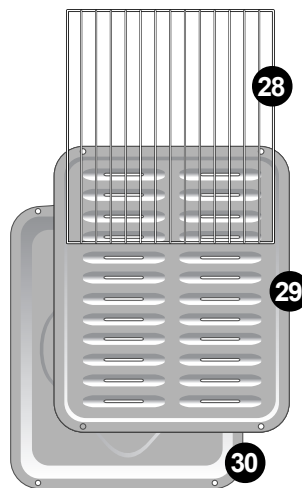
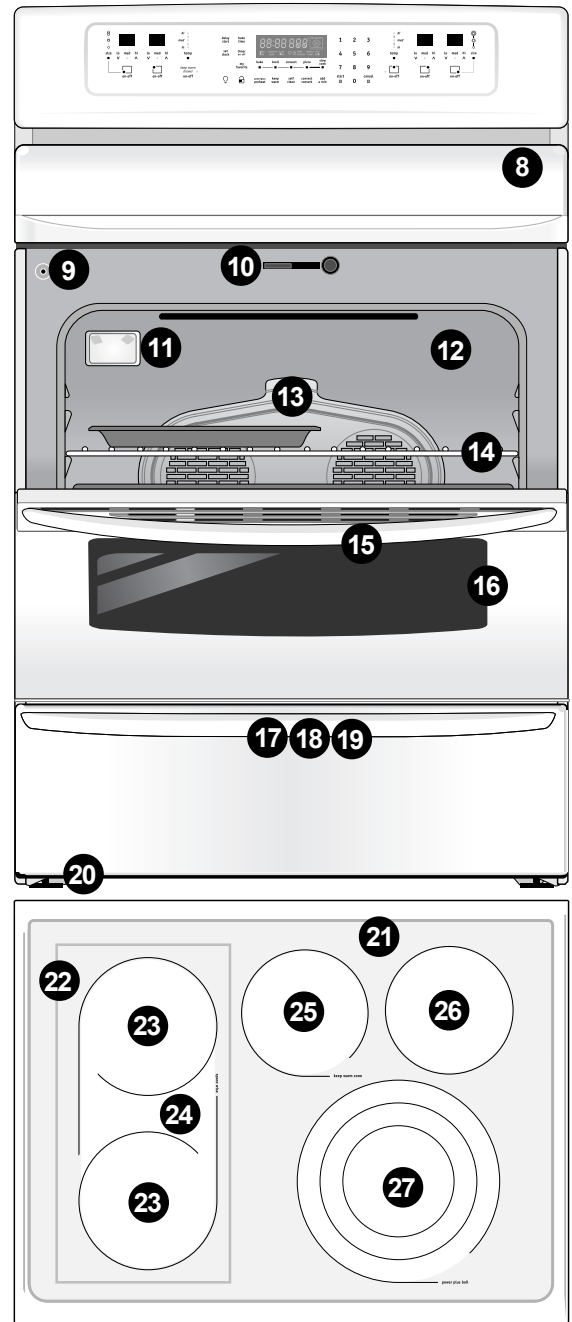

Note: The features shown for your appliance may vary according to model type & color.

Be sure to visit us online at  
[www.frigidaire.com](http://www.frigidaire.com)  
 for a complete line of accessories.

## BEFORE SETTING OVEN CONTROLS

### Oven vent location

The oven vent is located **under the left side of the control panel** (Fig. 1). When the oven is heating, warm air passes through this vent. The venting is necessary for proper air circulation in the oven which provides good baking results. **Do not block the oven vent.**

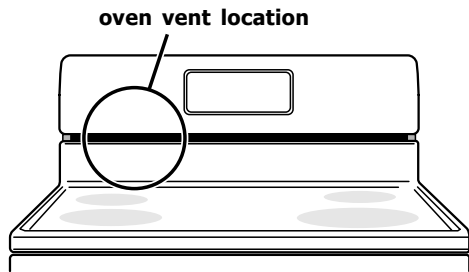

Fig. 1

### Oven racks

#### CAUTION

Always use **oven mitts** to protect hands from possible burns when using the oven or cooktop. The oven, oven racks and cooktop will become **very hot**.

#### IMPORTANT

Do not remove or attempt to arrange oven racks with cookware still on the racks. To avoid damaging cookware or spilling food items, always remove any cookware first.

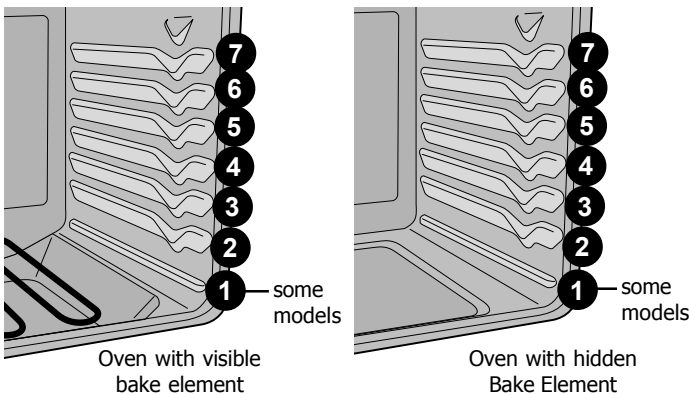

Fig. 2

### Recommended oven rack positions by food type

Food type	Position
Broiling meats	See broil
Cookies, cakes, pies, biscuits & muffins	4 or 5
Frozen pies, angel food cake, yeast, bread and casseroles	2 or 3
Small cuts of meat or poultry	2 or 3
Turkey, roast or ham	1 or 2

Use only the offset oven (if equipped) rack if you choose to use rack position 7.

### Oven rack stop

Most oven racks slide on rack guides provided along the oven cavity sides. The rack guides are curved near the front of each guide. The curve will catch and hold the oven rack stable into a stop position when an oven rack is extended straight out from the oven.

For better access to food items in the oven, **slowly** pull the oven rack straight out to the oven rack stop position (Fig. 3) before checking on food items or removing food dishes from the oven.

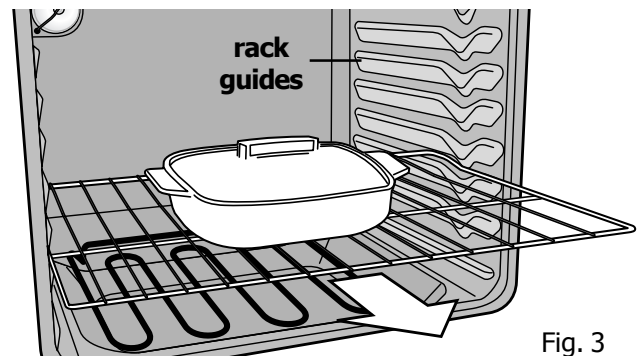

Fig. 3

### Removing, replacing & arranging most oven racks types

**Arranging** - always arrange oven racks when the oven is cool (prior to operating the oven).

**To remove** - Pull the oven rack straight out until it reaches the stop position. Tilt up front of oven rack to slide past the stop position and pull the rack out of the oven cavity (Fig. 4).

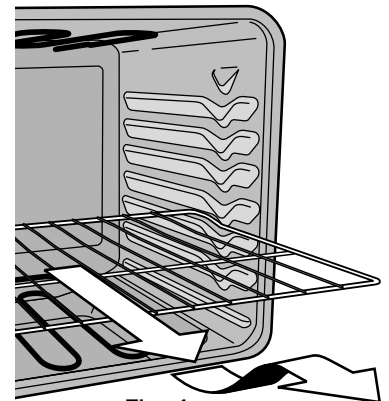

Fig. 4

**To replace** - Rest the oven rack evenly between a left and right front guide along the oven walls so that the oven rack rests level. Tilt front of rack upward and slide rack in past the stop position. Then bring the rack to a level position and slide the rack completely inside oven (Fig. 5).

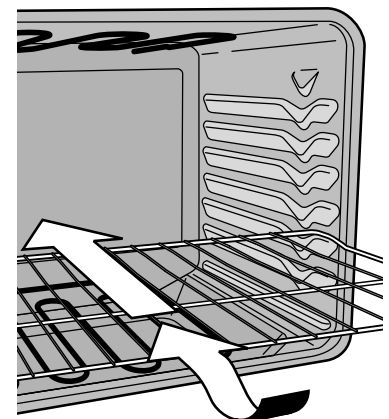
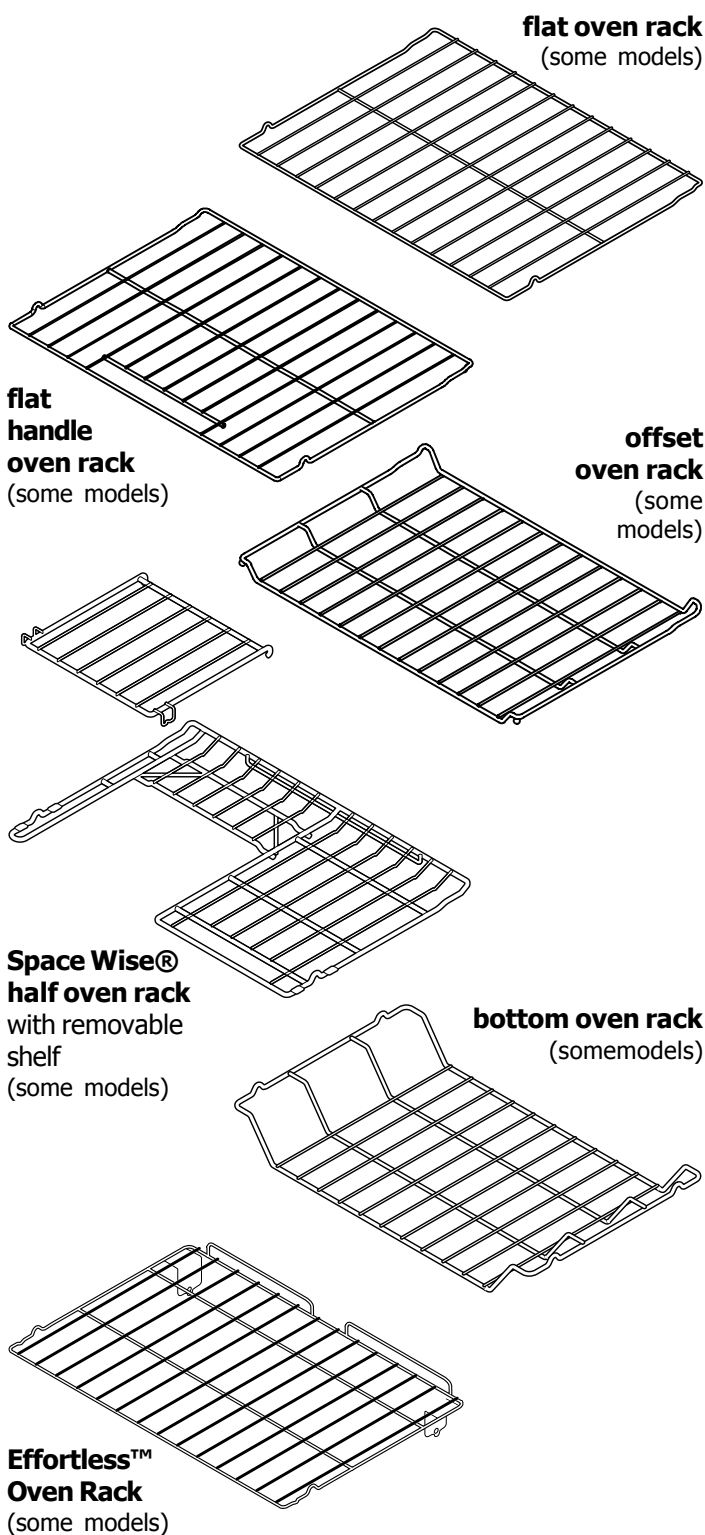

Fig. 5

## BEFORE SETTING OVEN CONTROLS



### Types of oven racks

Your range may be equipped with one or more of the following oven rack types listed below:

The **flat oven rack** (some models) may be used for most cooking needs and may be placed in most rack positions.

The **flat handle oven rack** (some models) may be used for most cooking needs. May be placed in most rack positions. Similar to the flat oven rack but comes with a built-in handle.

The **offset oven rack** (some models) provides additional stepdown positions from the standard flat rack design. The offset design positions the base of the rack about 1/2 of a rack position lower than the flat rack and may be used in most oven rack positions.

The **Space Wise® half oven rack** (some models) has a removable section to allow for taller cooking utensils in the oven. When the removable section is in place, the rack may be used like the flat oven rack.

The **Effortless™ Oven Rack** (some models) instructions are provided later in this section.

The **bottom oven rack** (some models) should only be used in the lowest oven rack position. To maximize oven space, place cookware on the bottom oven rack for example when roasting large cuts of meat. Do not use the **bottom oven rack** in any other oven rack position.

### Air circulation in the oven

For best baking results allow 2 to 4 inches (5-10 cm) around the cookware for proper air circulation and be sure pans and cookware do not touch each other, the oven door, sides or back of the oven cavity. For even heating and baking results, hot air must be able to circulate freely around the cookware (Fig. 1).

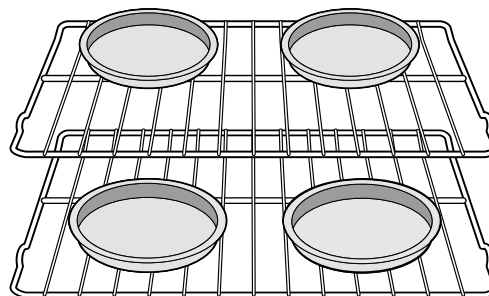

Fig. 1

### Baking layer cakes with 1 or 2 oven racks

For best results when baking cakes using 2 oven racks, place cookware on rack in positions 2 & 5. For best results when using a single or an offset oven rack, place cookware on rack in position 2, 3 or 4.



## BEFORE SETTING OVEN CONTROLS

**Effortless™ Oven Rack system** (some models)  
Some models are equipped with a special oven rack system that automatically partially extends the oven rack from the interior oven glides to assist in easier access to your food items. This feature works whenever the oven door is opened or closed.

### To assemble the Effortless™ Oven Rack system:

1. Locate all required parts. You will need the supplied oven rack (Effortless™ Oven Rack is a flat rack with a special **dark coating** on the **left and right rack sides**) and the 2 supplied chrome connector arms.
2. Open the oven door. Be sure the oven is completely cool before proceeding.
3. Place the oven rack in positions **2, 3 or 4 only** (see previous page to verify positions). Be sure the rack connector brackets are at the rear of the range and pointing towards oven bottom (See Fig. 2).
4. Assemble one connector arm at a time. With the oven door open and the oven rack in place, install one end of the connector arm to the hole in the **door connector bracket** (Fig. 1) and the other end in the hole in the **rack connector bracket** (Fig. 2 and as in Fig. 3). The oven rack may need to be adjusted in or out in the rack position to match the length of the connector arm.
5. While holding the connector arm in place, twist the connector arm so the ends of the connector arm point **upwards** (See Figs. 4 & 5). The connector arm should now be locked into position.
6. Repeat steps 4 and 5 for the other connector arm.
7. Once both connector arms are properly in place, be sure to test the oven rack operation by gently closing the oven door. The oven rack should move in and out of the oven freely when the door is opened or closed.

### CAUTION

**Never pick up hot oven rack parts.** Make sure the oven and oven racks are COMPLETELY cool and safe to touch before attempting to assemble or disassemble the Effortless™ Oven Rack.

### IMPORTANT

**Remove ALL oven racks and accessories before starting a self-clean cycle.** If the oven racks are left in the oven during self-clean, the glide ability of the Effortless™ Oven Rack system will be damaged and will cause oven racks to lose their shiny finish. Remove **ALL** oven racks and clean according to instructions provided in the Care & Cleaning section of this manual.

### IMPORTANT

**Only the Effortless™ Oven Rack system should be used in oven rack position 2.** Placing ANY other rack in oven rack position 2 **will prevent the oven door from fully closing** and may damage the oven door, oven cavity or the door connector brackets.

If the rack system is not assembled with the connector arms the Effortless™ Oven rack may be used in oven rack positions 2 thru 6. Do not attempt to use the Effortless™ Oven rack in rack position 1.

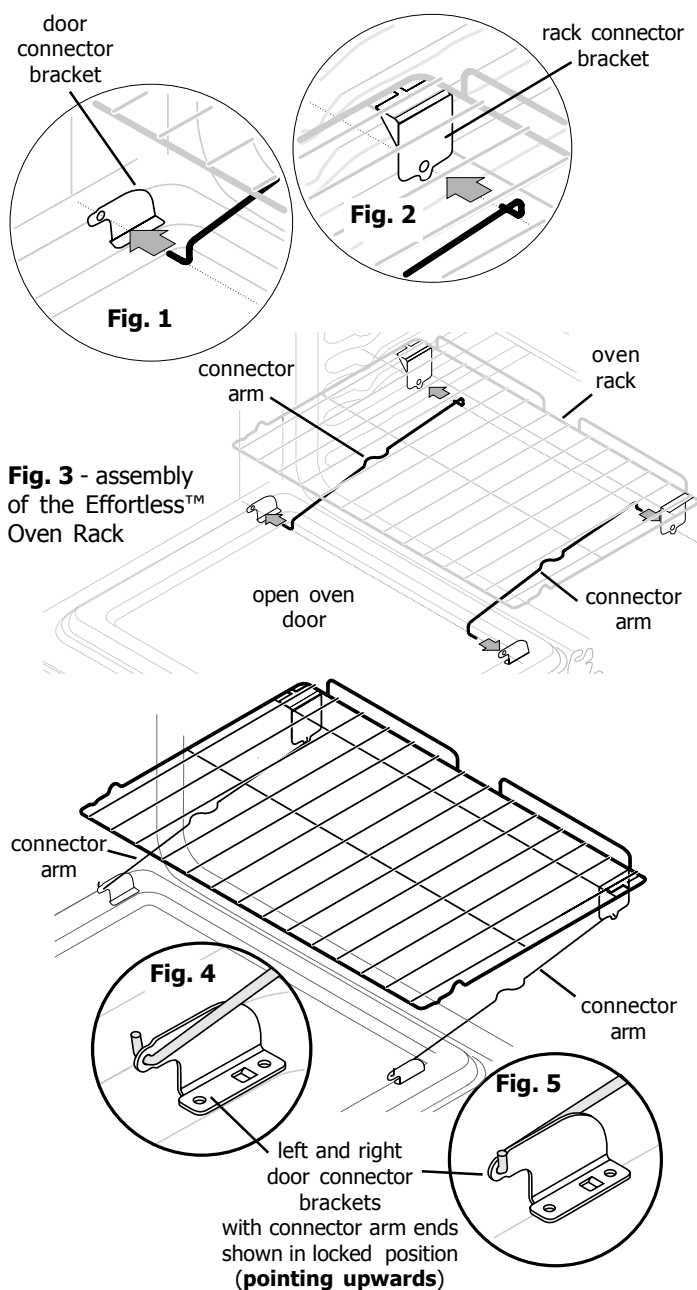

Fig. 6 - Effortless™ Oven Rack after assembly

## BEFORE SETTING SURFACE CONTROLS

### Cookware material types for the cooktop

The cookware material determines how evenly and quickly heat is transferred from the surface element to the pan bottom. The most popular materials available are:

**Aluminum** - Excellent heat conductor. Some types of food will cause it to darken (Anodized aluminum cookware resists staining & pitting). If aluminum pans slide across the ceramic cooktop, they may leave metal marks which will resemble scratches. Remove these marks immediately.

**Copper** - Excellent heat conductor but discolors easily. May leave metal marks on ceramic glass (see Aluminum).

**Stainless** - Slow heat conductor with uneven cooking results. Is durable, easy to clean and resists staining.

**Cast Iron** - A slow heat conductor however will retain heat very well. Cooks evenly once cooking temperature is reached. Not recommended for use on ceramic cooktops.

**Porcelain-enamel on metal** - Heating characteristics will vary depending on base material. Porcelain-enamel coating must be smooth to avoid scratching ceramic cooktops.

**Glass** - Slow heat conductor. Not recommended for ceramic cooktop surfaces because it may scratch the glass.

### Using proper cookware

The size and type of cookware used will influence the setting needed for best cooking results. Be sure to follow the recommendations for using proper cookware as illustrated in Figs. 1 & 2.

Cookware should have flat bottoms that make good contact with the entire element (See Fig. 1). Check for flatness by rotating a ruler across the bottom of the cookware (Fig. 2). For more information about the ceramic cooktop see "Cooktop Cleaning" and "Cooktop Maintenance" in the **Care & Cleaning** section.

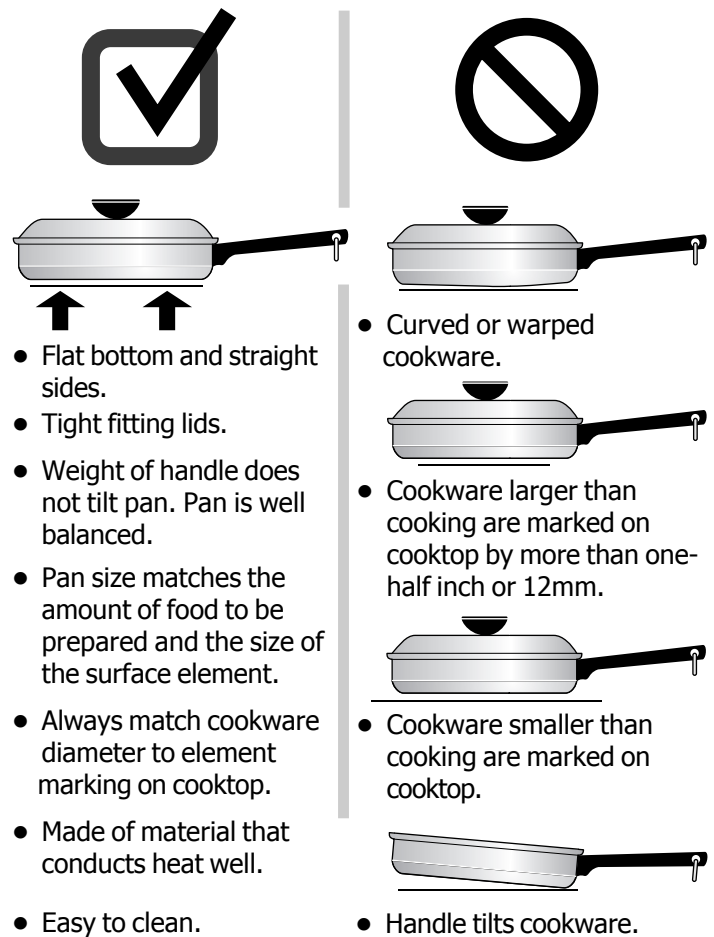

Fig. 1

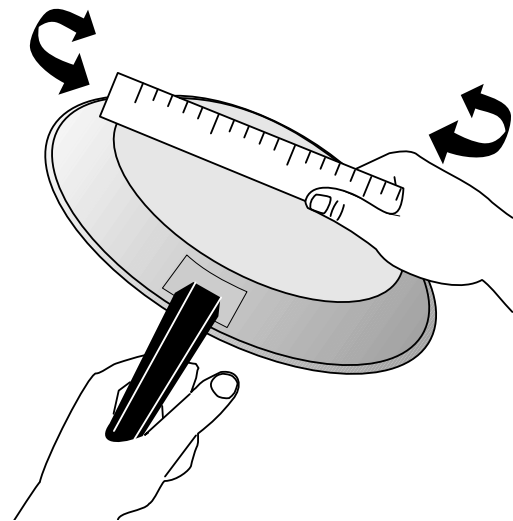

Fig. 2

## BEFORE SETTING SURFACE CONTROLS

### About the ceramic glass cooktop

Located under the surface of the glass ceramic cooktop are radiant surface elements. The design patterns on the cooktop outlines the size of the heating area for each surface element. **Be sure** to match the pan size with the diameter of the element outline on the cooktop and use only quality flat-bottomed cookware.

The type and size of cookware, the number of surface elements in use and their power level settings are all factors that will affect the amount of heat that will spread to areas beyond the surface elements. The areas surrounding the elements may become **hot enough to cause burns**.

### About the surface elements

When activated, the surface element temperature rises gradually and evenly. As the temperature rises, the element will glow red. To maintain the selected power setting the element will cycle ON and OFF. The element will retain enough heat to provide a uniform heat during the off cycle.

For efficient cooking, turn the element OFF several minutes before cooking is complete. This will allow residual heat to complete the cooking process.

#### ➔ IMPORTANT

- The **HE** (hot element) message will appear in the display windows once a heating element is turned OFF and will remain ON until the heating surface area or areas have cooled sufficiently.
- **Do not allow aluminum foil, or ANY material that can melt to make contact with the ceramic glass cooktop.** If these items melt on the cooktop they can damage the ceramic cooktop.

#### 📌 NOTES

- Radiant elements have a limiter that will make the element **cycle** ON and OFF, even at the high setting. This helps prevent damage to the ceramic smoothtop. Cycling at the high setting is normal and will occur more frequently if the cookware is too small for the radiant element or if the cookware bottom is warped.
- **Be sure** to read the detailed instructions for "Cooktop Maintenance" and "Cooktop Cleaning" in the **Care & Cleaning** section.

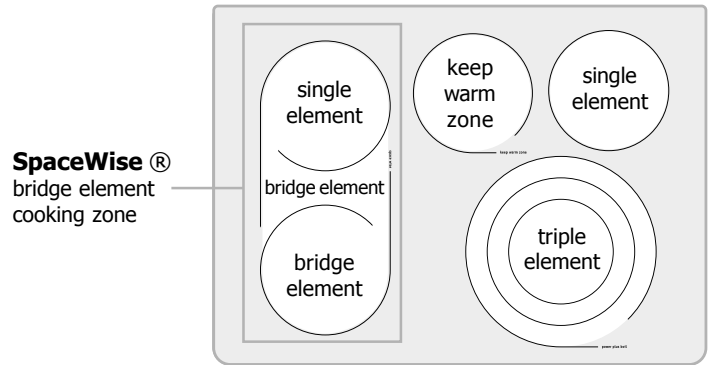

Fig. 1  
(surface element and cooking zone locations)

The right and left rear **single** radiant element positions will be marked on the cooktop with a round outline pattern shown (See Fig. 1).

The **keep warm** zone will keep hot cooked foods at serving temperature. Use the keep warm feature to keep cooked foods hot such as; vegetables, gravies, casseroles, soups, stews, breads, pastries and oven-safe dinner plates.

The **Space Wise®** Bridge Element feature allows the user to set the left front cooking element alone or along with the middle (bridge portion) and if desired add the left rear element into one combined cooking zone (Fig. 1). The left front and left rear elements may also be used as single independent heating elements whenever needed.

#### power plus boil

**Power Plus® Boil** feature (some models)

Your appliance may be equipped with one or more surface elements on the cooktop marked **power plus boil**. Use this element position when bringing a large amount of liquid to temperature or when preparing larger amounts of food.

## BEFORE SETTING SURFACE CONTROLS

### Cooktop display windows

Located on the backguard are **digital displays** for each of the heating positions located on the cooktop. Surface element power levels can easily be controlled and monitored using these displays in combination with the corresponding control keypads.

The triple element (some models) feature provides 3 different size settings to choose from a single location on the cooktop.

### Available power level settings

The cooktop control will display heat levels ranging from **Hi** (Fig. 1) to **Lo** (Fig. 6) and **Off** (Fig. 7). The Hi setting is the highest available heat level.

The settings between **9.5** (Fig. 2) and **3.0** (Fig. 3) may be adjusted in increments of .5 (1/2).

The settings between **2.8** (Figs. 4) and **1.2** (Fig. 5) are simmer settings which may be adjusted in increments of .2 for more precise heat levels.

**Lo** (Fig. 6) is the lowest heat level available.

Use the "Suggested power level settings table" provided later in this section to determine the correct setting for the type of food you are preparing.

### Hot surface window message (HE)

After using any radiant element the cooktop will be very hot. Even after turning the elements OFF, the cooktop will remain HOT for some time afterwards. The corresponding **HE** (hot element - Fig. 8) message will remain ON and turn OFF once that element position on the cooktop has cooled sufficiently (Fig. 7).

### Lock window message ( - - )

The ( - - ) message will appear whenever the **lock** feature is active (See Fig. 9). Refer to the lock instructions in the **Setting Oven Controls** section for detailed instructions.

### Sabbath feature (Sb) message

The display windows will show the **Sb** message whenever the Sabbath feature is active (Fig. 10). When activated, the Sabbath feature works for both the oven and cooktop operations

Once the **Sabbath** feature is active, changes to the heat levels for the cooktop elements will not appear in the displays. The cooktop will react slower to heat level changes. See "Setting the Sabbath feature" for complete instructions.

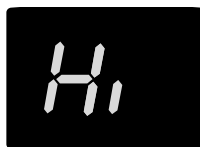

Fig. 1



Fig. 2



Fig. 3



Fig. 4

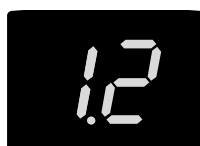

Fig. 5

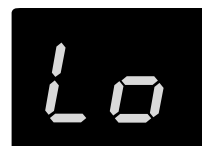

Fig. 6

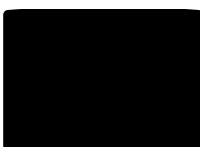

Fig. 7



Fig. 8

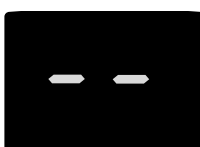

Fig. 9



Fig. 10

### NOTE

(For models equipped with a bridge feature only) When setting all 3 bridge elements to heat together, both display windows for the left front and left rear elements will display the same set power level & hot element messages.

## SETTING SURFACE CONTROLS

### Suggested surface element settings

The suggested surface element settings listed below are based when cooking with medium-weight aluminum pans with lids. Settings may vary when using other types of pans.

### Suggested power level settings table

Settings	Type of cooking
High (8.0-Hi)	Start most foods, bring water to a boil, pan broiling
Medium high (5.0 - 8.0)	Continue a rapid boil, fry, deep fat fry
Medium (3.0 - 5.0)	Maintain a slow boil, thicken sauces and gravies or steam vegetables
Medium Low (2.0 - 4.0)	Keep foods cooking, poach, stew (2.8 or lower is a simmer setting)
Low (Lo - 2.0)	Keep warm, melt, simmer (2.8 or lower is a simmer setting)

Fig. 1- for radiant surface elements except warmer zone

### ➔ IMPORTANT

The size and type of utensil used, and the amount and type of food being cooked will influence the setting needed for best cooking results.

### Single surface elements

Both the left and right rear cooking positions on the cooktop may be used as single surface elements.

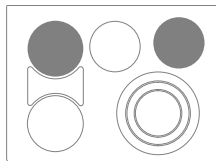

### ⚠ CAUTION

- Radiant surface elements may appear to have cooled after they have been turned off. The glass surface **may still be hot** and burns may occur if the glass surface is touched before it has cooled sufficiently.
- To avoid possible burns always use potholders or oven mitts when handling cookware on the cooktop or whenever moving cookware to and from the cooktop.
- **Do not place flammable items** such as plastic salt and pepper shakers, spoon holders or plastic wrappings on the cooktop when it is in use. These items could melt or ignite. Potholders, towels or wooden spoons could catch fire if placed too close to the surface elements.

### To operate the single surface elements:

- | Step   | Press   |
|--|---|
| 1. Place correctly sized cookware on the radiant surface element.  | <b>on-off</b>                                 |
| 2. Press and hold the <b>on-off</b> for the desired element position until a beep is heard.  |   |
| 3. Select power level setting. Press <b>lo</b> , <b>med</b> (5.0) or <b>hi</b> . Each touch of the <b>lo</b> or <b>hi</b> pad will increase or decrease the power level by 1/2 from <b>3.0</b> through <b>9.5</b> . Simmer power levels between <b>1.2</b> and <b>3.0</b> will increase or decrease by .2 increments. <b>lo</b> is the lowest power level available. | <b>lo</b> , <b>med</b> , <b>hi</b><br>v , , ^ |
| 4. When finished cooking press <b>on-off</b> .   | <b>on-off</b>                                 |

### 📌 NOTES

- Start most cooking operations at a higher heat setting and then turn to a lower setting to finish cooking.
- For efficient cooking, turn the surface element OFF several minutes before cooking is complete. This will allow residual heat to complete the cooking process.
- A glowing red surface heating area extending beyond the bottom edge of the cookware indicates the cookware is **too small** for the surface heating area.
- Radiant elements have a limiter that will make the element **cycle ON and OFF**, even at the high setting. This helps prevent damage to the ceramic smoothtop. Cycling at the high setting is normal and will occur more frequently if the cookware is too small for the radiant element or if the cookware bottom is warped.

### ➔ IMPORTANT

The cooktop provides two other element portions that may be used as a single element. Be sure to follow the appropriate bridge or triple element instructions provided when setting these a single element.

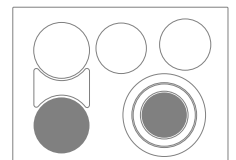

## SETTING SURFACE CONTROLS

### Bridge element

#### space wise

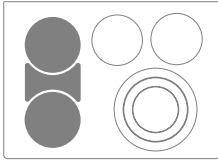

The **Space Wise®** bridge element allows the user to set the left front cooking element alone or together with the middle element, and if desired add the left rear element into a single long combined cooking zone.

#### To operate the bridge surface element:

- | Step   | Press                         |
|--|-------------------------------|
| 1. Place correctly sized cookware on the bridge surface cooking zone.  |                               |
| 2. To activate press and hold the <b>on-off</b> bridge keypad and release when the acceptance tone sounds.   | on-off                        |
| 3. Set the element size. Press <b>size</b> once for left front (Fig. 1), twice for left front with middle (Fig. 2), 3 times for front, middle and rear (Fig. 3).   | size<br>■                     |
| 4. Select power level setting. Press <b>lo</b> , <b>med</b> (5.0) or <b>hi</b> . Each touch of the <b>lo</b> or <b>hi</b> pad will increase or decrease the power level by 1/2 from <b>3.0</b> through <b>9.5</b> . Simmer power levels between <b>1.2</b> and <b>3.0</b> will increase or decrease by .2 increments. <b>lo</b> is the lowest power level available. | lo    hi<br>v    , med ,    ^ |
| 5. When finished cooking press <b>on-off</b> .   | on-off                        |

See the **Suggested power level settings table** (provided with instructions for the single radiant elements).

### CAUTION

- Radiant surface elements may appear to have cooled after they have been turned off. The glass surface **may still be hot** and burns may occur if the glass surface is touched before it has cooled sufficiently.
- To avoid possible burns always use potholders or oven mitts when handling cookware on the cooktop or whenever moving cookware to and from the cooktop.
- **Do not place flammable items** such as plastic salt and pepper shakers, spoon holders or plastic wrappings on the cooktop when it is in use. These items could melt or ignite. Potholders, towels or wooden spoons could catch fire if placed too close to the surface elements.

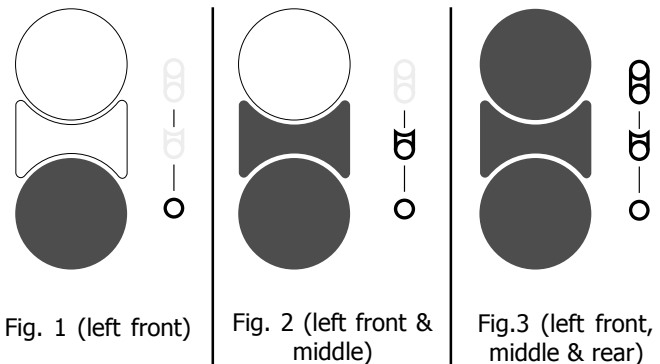

Fig. 1 (left front)

Fig. 2 (left front & middle)

Fig.3 (left front, middle & rear)

### NOTES

- The bridge element size may be changed anytime the element is ON.
- If all 3 bridge elements are set to be active together and the left rear element is needed with a different power level setting, change the bridge size to **○** or **⊔** and then set the left rear power level independently.
- Start most cooking operations at a higher heat setting and then turn to a lower setting to finish cooking.
- For efficient cooking, turn the surface element OFF several minutes before cooking is complete. This will allow residual heat to complete the cooking process.
- A glowing red surface heating area extending beyond the bottom edge of the cookware indicates the cookware is **too small** for the surface heating area.
- Radiant elements have a limiter that will make the element **cycle** ON and OFF, even at the high setting. This helps prevent damage to the ceramic smoothtop. Cycling at the high setting is normal and will occur more frequently if the cookware is too small for the radiant element or if the cookware bottom is warped.

### IMPORTANT

The **HE** (hot element) message will appear in the display window after turning OFF an element that has been heating long enough to become hot. This message will remain displayed until the heating surface area or areas have cooled sufficiently.

## SETTING SURFACE CONTROLS

### Triple element

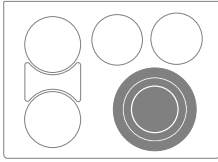

The cooktop is featured with an expandable triple radiant surface element located at the right front cooktop position. This element may be set to operate for 3 different sizes.

#### To operate the triple surface element:

- | Step   | Press                  |
|--|------------------------|
| 1. Place cookware on the triple radiant surface cooking zone.  |                        |
| 2. To activate press and hold the <b>on-off</b> triple element keypad and release when the acceptance tone sounds.   | on-off                 |
| 3. Set the element size. Press <b>size</b> once for inner, twice for inner and middle, 3 times for all 3 element portions).  | size<br>■              |
| 4. Select power level setting. Press <b>lo</b> , <b>med</b> (5.0) or <b>hi</b> . Each touch of the <b>lo</b> or <b>hi</b> pad will increase or decrease the power level by 1/2 from <b>3.0</b> through <b>9.5</b> . Simmer power levels between <b>1.2</b> and <b>3.0</b> will increase or decrease by .2 increments. <b>lo</b> is the lowest power level available. | lo , med , hi<br>v , ^ |
| 5. When finished cooking press <b>on-off</b> .   | on-off                 |

See the **Suggested power level settings table** (provided with instructions for the single radiant elements).

### CAUTION

- Radiant surface elements may appear to have cooled after they have been turned off. The glass surface **may still be hot** and burns may occur if the glass surface is touched before it has cooled sufficiently.
- To avoid possible burns always use potholders or oven mitts when handling cookware on the cooktop or whenever moving cookware to and from the cooktop.
- **Do not place flammable items** such as plastic salt and pepper shakers, spoon holders or plastic wrappings on the cooktop when it is in use. These items could melt or ignite. Potholders, towels or wooden spoons could catch fire if placed too close to the surface elements.



○  
**size**  
■  
Fig. 1 - inner portion heats only.

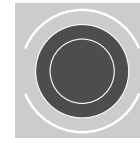

○  
**size**  
■  
Fig. 2 - inner and middle portions will heat.



○  
**size**  
■  
Fig. 3 - all portions will heat.

### NOTES

- The triple element size may be changed anytime the element is on.
- Start most cooking operations at a higher heat setting and then turn to a lower setting to finish cooking.
- For efficient cooking, turn the surface element OFF several minutes before cooking is complete. This will allow residual heat to complete the cooking process.
- A glowing red surface heating area extending beyond the bottom edge of the cookware indicates the cookware is **too small** for the surface heating area.
- Radiant elements have a limiter that will make the element **cycle** ON and OFF, even at the high setting. This helps prevent damage to the ceramic smoothtop. Cycling at the high setting is normal and will occur more frequently if the cookware is too small for the radiant element or if the cookware bottom is warped.

### IMPORTANT

The **HE** (hot element) message will appear in the display window after turning OFF an element that has been heating long enough to become hot. This message will remain displayed until the heating surface area or areas have cooled sufficiently.

# SETTING SURFACE CONTROLS

## Keep warm zone

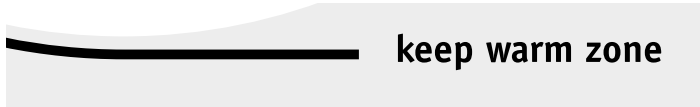

keep warm zone

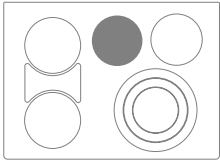

The purpose of the **keep warm** zone is to keep hot cooked foods at serving temperature. These include foods like; vegetables, gravies, casseroles, soups, stews, breads, pastries and oven-safe dinner plates.

Always start with hot food. It is not recommended to heat cold food on the keep warm zone. All food placed on the keep warm zone should be covered with a lid to maintain quality.

For best results, when warming pastries or breads, the cover should have an opening to allow moisture to escape. **Do not use plastic wrap to cover food. Plastic may melt onto the surface and be very difficult to clean.** Use only dishware, utensils and cookware recommended for oven and cooktop use on the keep warm zone.

### Keep warm zone temperature selection

If a particular food is not listed, start with the medium heat level, and adjust as needed. Most foods can be kept at serving temperatures by using the medium heat level (Refer to Fig. 1).

### Keep warm zone recommended food settings table

Food Item	Heating Level
Breads/Pastries	lo (Low)
Casseroles	lo (Low)
Dinner plates with food	lo (Low)
Eggs	lo (Low)
Gravies	lo (Low)
Meats	med (Medium)
Sauces	med (Medium)
Soups (cream)	med (Medium)
Stews	med (Medium)
Vegetables	med (Medium)
Fried foods	hi (High)
Hot beverages	hi (High)
Soups (liquid)	hi (High)

Fig. 1

## IMPORTANT

**Do not allow aluminum foil, or ANY material that can melt to make contact with the ceramic glass cooktop.** If these items melt on the cooktop they can damage the ceramic cooktop.

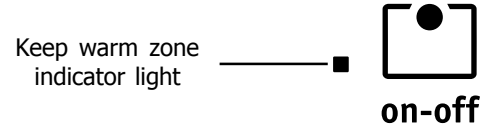

### To operate keep warm zone:

- | Step   | Press  |
|--|--------|
| 1. Place cookware on the <b>keep warm zone</b> .   |        |
| 2. Press <b>on-off</b> for the keep warm zone position (The keep warm indicator light will turn on).   | on-off |
| 3. Press <b>temp</b> keypad until desired temperature setting is displayed. (Refer to Figs. 2, 3 & 4). | temp   |
| 4. When finished warming press <b>on-off</b> .   | on-off |

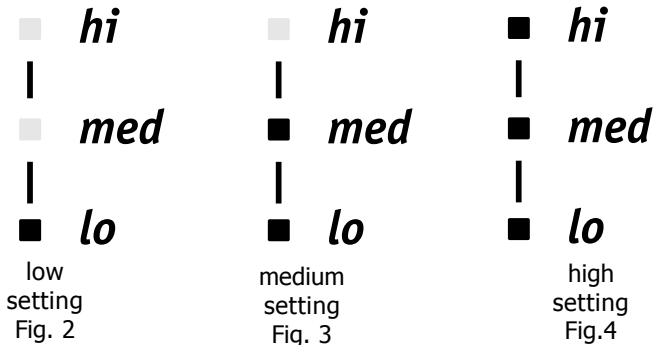

## CAUTION

- Unlike other surface elements, the keep warm zone will not glow red when it is hot. To avoid possible burns always use potholders or oven mitts when moving food to and from the **keep warm zone** as cookware and plates **will be hot**.
- Radiant surface elements may appear to have cooled after they have been turned off. **The glass surface may still be hot** and burns may occur if the glass surface is touched before it has cooled sufficiently.
- **Do not place flammable items** such as plastic salt and pepper shakers, spoon holders or plastic wrappings on top of the range when it is in use. These items could melt or ignite. Potholders, towels or wooden spoons could catch fire if placed too close to the surface elements.



## SETTING SURFACE CONTROLS

### Home canning

Be sure to read and observe all the following points when home canning using your appliance.

#### IMPORTANT

**NEVER** place or straddle a cooking utensil over 2 different surface cooking areas at the same time. This may cause the ceramic cooktop to fracture.

- Use only quality flat bottom canners when home canning. Use a straight-edge to check canner bottom. Be sure the cookware has no ridges that radiate from the bottom center when home canning using a ceramic cooktop.
- Start with hot tap water to bring water to boil more quickly.
- Use the highest heat setting when first bringing the water to a boil. Once boiling is achieved, reduce heat to lowest possible setting to maintain that boil.
- **Make sure the diameter of the canner does not exceed 1 inch beyond the surface element markings or burner.** It is recommended to use smaller diameter canners on electric coil and ceramic glass cooktops.
- When using two canners at the same time, stagger the canners on the left and right sides of the cooktop. This will help distribute the heat generated more evenly.

Be sure to review the latest online information for home canning. Some suggestions might be the *U.S. Department of Agriculture Food Safety and Inspection Service* or the *National Center for Home Food Preservation (NCHFP)*.

#### CAUTION

- Radiant surface elements may appear to have cooled after they have been turned off. **The glass surface may still be hot** and burns may occur if the glass surface is touched before it has cooled sufficiently.
- **Do not place flammable items** such as plastic salt and pepper shakers, spoon holders or plastic wrappings on top of the range when it is in use. These items could melt or ignite. Potholders, towels or wooden spoons could catch fire if placed too close to the surface elements.

#### IMPORTANT

**Do not allow aluminum foil, or ANY material that can melt to make contact with the ceramic glass cooktop.** If these items melt on the cooktop they can damage the ceramic cooktop.

# OVEN CONTROL FUNCTIONS

## READ THE INSTRUCTIONS CAREFULLY BEFORE USING THE OVEN.

For satisfactory use of your oven, become familiar with the various pad functions of the oven as described below.

**delay start** — Use with **bake, convect, convect convert** and **self-clean** features to program a delayed time bake or delayed self-cleaning cycle.

**timer on/off** — Use to set or cancel the minute timer.

**set clock pad** — Use to set the time of day.

**my favorite** — Use to store & recall favorite recipes.

**bake** — Use to set the normal Bake feature.

**oven light** — Use to turn the oven light ON and OFF.

**lock** — Use to activate or cancel the lock setting.

**bake time** — Use to set the length of baking time needed.

**broil** — Use to set broil feature.

**convect** — Use to set the convect bake, convect roast or convect broil.

**pizza** — Use to set the pizza features.

**slow cook** — Use to set slow cook and settings.

**0 thr 9 number pads** — Use to enter temperature and times.

delay start  
bake time  
set clock  
timer on-off

my favorite

powerplus preheat  
keep warm  
self clean  
convect convert  
add a min

powerplus preheat  
keep warm  
self clean  
convect convert  
add a min

**self-clean** — Use to set a 2, 3 or 4 hour self-clean cycle.

**add a min** — Use to add minutes to the timer.

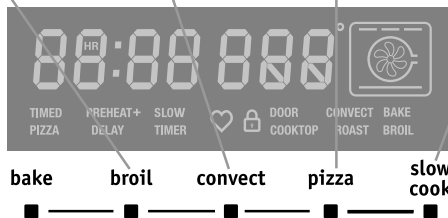

**start** — Use to start all oven features (not used with oven light).

**cancel** — Use to cancel any oven mode previously entered except the oven lockout, time of day & minute timer. Press **cancel** to stop cooking.

## Minimum & maximum control settings

The features listed have minimum and maximum time or temperature settings that may be entered or adjusted using the oven control numeric keypads.

An entry **acceptance tone** (1 beep) will sound each time a keypad is touched (the oven lock keypad is delayed 3 seconds).

An entry **error tone** (3 short beeps) will sound if the entry of the temperature or time is below the minimum or above the maximum settings for the feature.

Feature	Min. temp. /time	Max. temp. /time
quick preheat temperature	170°F / 77°C	550°F / 288°C
bake temperature	170°F / 77°C	550°F / 288°C
broil temperature	400°F / 205°C	550°F / 288°C
timer	1 min.	11 hrs., 59 mins.
bake time	1 min.	6 hours
delay start	1 min.	11 hrs., 59 mins.
self-clean time	2 hours	4 hours
convect bake temperature	170°F / 77°C	550°F / 288°C
convect roast temperature	170°F / 77°C	550°F / 288°C
convect broil temperature*	400°F / 205°C	550°F / 288°C
pizza temperature (electric)	170°F / 77°C	550°F / 288°C

\*convect broil available on some models.

## SETTING OVEN CONTROLS

### Setting the clock

When the appliance is powered up for the first time or when the electric supply to the appliance has been interrupted, the display will **flash** "12:00" (Fig. 1).



Fig. 1

#### To set the clock for 1:30:

Step	Press
1. Press <b>set clock</b> .	<b>set clock</b>
2. Enter <b>1 3 0</b> .	<b>1 3 0</b>
3. Press <b>start</b> to accept.	<b>start</b>

#### NOTES

- Be sure to set the clock with the correct time of day before using the oven.
- The clock cannot be adjusted when the oven is active with any cooking function or during self-clean.

### Changing between 6-Hour Energy Saving or continuous bake mode settings

The oven control is factory preset with to the 6 Hour Energy Saving mode that will automatically turn the oven off after 6 hours. The control may also be programmed to override this feature to continuously bake.

#### To switch between 6-Hour Energy Saving or continuous bake modes:

Step	Press
1. Press and hold <b>timer on • off</b> for 6 seconds.	<b>timer on • off</b>
2. Press <b>self-clean</b> to toggle between "6 Hr OFF" (Fig. 2) or "StAY On" (Fig. 3) and release keypad.	<b>self clean</b>
3. Press <b>start</b> to accept.	<b>start</b>



Fig. 2



Fig. 3

#### NOTE

Changing between the 6-Hour Energy Saving or continuous bake mode will not change how the cooktop controls operate.

### Setting 12 or 24 hour display mode

The oven control is factory preset to show the time of day with a 12 hour clock. This setting may be changed to provide the time of day with a 24 hour clock.

#### To set 12 or 24 hour display mode:

Step	Press
1. Press and hold <b>set clock</b> for 6 seconds.	<b>set clock</b>
2. Press <b>self-clean</b> to toggle between "12 Hr dAY" or "24 Hr dAY" display modes (See Figs. 4 & 5) and release keypad when the mode you prefer is displayed.	<b>self clean</b>
3. Press <b>start</b> to accept.	<b>start</b>



Fig. 4

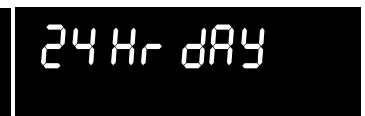

Fig. 5

## SETTING OVEN CONTROLS

### Changing oven temperature display mode

The oven control is preset to display the oven temperature with Fahrenheit values. The control may be changed to display either Fahrenheit or Celsius temperatures.

#### To change the temperature display mode:

- | Step   | Press             |
|--|-------------------|
| 1. Press and hold <b>broil</b> for 6 seconds.  | <b>broil</b>      |
| 2. Press <b>self-clean</b> to toggle between Fahrenheit or Celsius temperature display modes and release keypad when the mode you prefer is displayed. | <b>self clean</b> |
| 3. Press <b>start</b> to accept.   | <b>start</b>      |

#### NOTE

The temperature display mode option cannot be changed when the oven is active with any cooking function or during self-clean.

### Setting for audible or silent keypad operation

Normally a beep will sound each time a keypad is pressed. If desired, the control may be set for silent keypad operation.

#### To switch between audible or silent keypad operation modes:

- | Step  | Press              |
|---|--------------------|
| 1. Press and hold <b>delay start</b> for 6 seconds.   | <b>delay start</b> |
| 2. Press <b>self-clean</b> to toggle between "bEEP On" (Fig. 1) or "bEEP OFF" (Fig. 2). Release keypad when the mode you prefer is displayed. | <b>self clean</b>  |
| 3. Press <b>start</b> to accept.  | <b>start</b>       |



Fig. 1



Fig. 2

#### NOTE

If the control is set for silent keypad operation the **timer**, **preheat** and any **end of cycle** or **error** tone alerts will remain audible.

### Setting lock

The control may be programmed to lock the oven door and lock the oven control keypad operations.

#### To activate the lock feature:

##### Step

Press



Press and hold **lock** keypad for 3 seconds. "door Loc" will appear in the display until the oven door is completely locked (Fig. 3).



Fig. 3

#### To cancel the lock feature:

##### Step

Press



Press and hold **lock** keypad for 3 seconds. Once the oven door has unlocked the "door Loc" message will turn off.

#### NOTES

- To avoid possible damage to the oven door latching mechanism, do not attempt to force open the oven door whenever the **door Loc** message is displayed.
- If a control keypad is pressed when the lock feature is active, the oven control may produce an error tone (triple beep) indicating the keypad action requested is not available when lock is active.

## SETTING OVEN CONTROLS

### Timer

The timer helps keep track of cooking times without interfering with the cooking process. The timer may be set for 1 minute up to 11 hours and 59 minutes.

#### To set the timer for 5 minutes:

- | Step                               | Press             |
|------------------------------------|-------------------|
| 1. Press <b>timer on•off</b> .     | timer<br>on • off |
| 2. Enter <b>5</b> minutes.         | <b>5</b>          |
| 3. Press <b>start</b> to activate. | <b>start</b>      |

To cancel the timer at any time press **timer on•off**.

When the timer countdown expires, "End" will appear in the display and alert the user with 3 beeps 1 second apart. The alert will continue until the **timer on•off** keypad is pressed.

### NOTES

- The timer **does not start or stop** the cooking process. The timer may be started alone or with any other active oven feature.
- The timer will display hours and minutes until 1 hour remains. When less than 1 hour remains, the display will count down in minutes and seconds. Once the timer has less than 1 minute remaining only seconds will display.
- If both the oven and timer are active, the timer information will display by default. To momentarily display information for any other active oven feature, press the keypad once for the active feature.

### Add a minute

Use the add a minute feature to set additional minutes to the timer. When the timer is active, each press of the keypad will add one additional minute to the timer.

#### To add two additional minutes to the timer:

- | Step                                    | Press        |
|---|--------------|
| Press <b>add a minute</b> keypad twice. | add<br>a min |

### NOTE

If the **add a minute** keypad is pressed once when the timer is inactive, the timer will activate and start counting down from one minute.

### Powerplus preheat

Use this feature to quickly preheat the oven. For best results use when baking with a **single rack only**. A reminder tone will sound indicating when to place the food in the oven. Powerplus preheat may be set for 170°F (77°C) to 550°F (288°C). The powerplus preheat default oven temperature is 350°F (177°C).

### CAUTION

Always use pot holders or oven mitts when working with a hot oven. When cooking, the oven, oven racks and cooktop will become **hot** enough to cause burns.

#### To set powerplus preheat using the default temperature of 350°F:

- | Step                                | Press                |
|-------------------------------------|----------------------|
| 1. Press <b>powerplus preheat</b> . | powerplus<br>preheat |
| 2. Press <b>start</b> .             | <b>start</b>         |

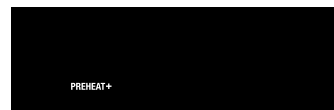

To stop preheat at any time press **cancel**.

#### To set power pluspreheat with oven temperature of 325°F:

- | Step                                | Press                |
|-------------------------------------|----------------------|
| 1. Press <b>powerplus preheat</b> . | powerplus<br>preheat |
| 2. Enter <b>3 2 5</b> .             | <b>3 2 5</b>         |
| 3. Press <b>start</b> .             | <b>start</b>         |

To stop preheat at any time press **cancel**.

### IMPORTANT

Once the oven has fully preheated, the powerplus preheat feature will perform like **bake** and continue to bake until cancelled.

### NOTES

- **bake time** and **delay start** setting may be added to preheat.
- **The convect fan will begin rotating** once powerplus preheat is started (some models). The convect fan will turn off once the oven set temperature is reached.

## SETTING OVEN CONTROLS

### Bake

Use the bake feature to prepare most food items when the recipe calls for normal baking. A reminder tone will sound once the oven finishes preheating. Bake may be set for any temperature from 170°F (77°C) to 550°F (288°C). If bake is programmed with no temperature, the control will default to 350°F (177°C).

### CAUTION

Always use pot holders or oven mitts when working with a hot oven. When cooking, the oven interior, oven racks and cooktop will become **hot** enough to cause burns.

#### To set bake with oven temperature of 425°F:

- | Step                    | Press        |
|-------------------------|--------------|
| 1. Press <b>bake</b> .  | <b>bake</b>  |
| 2. Enter <b>4 2 5</b> . | <b>4 2 5</b> |
| 3. Press <b>start</b> . | <b>start</b> |

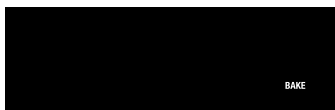

To stop baking at any time press **cancel**.

### NOTES

- If bake is active without **bake time** instructions and bake is not cancelled, the oven will continue to bake for 6 hours before automatically turning off.
- A **bake time** instruction may be added even when the bake feature is already active.
- **The convection fan will begin rotating** once bake is started. The convection fan will turn off once the oven set temperature is reached.

### IMPORTANT

Dark or dull pans absorb more heat than shiny bakeware resulting in dark or overbrowning of foods. It may be necessary to reduce the oven temperature or cook time to prevent overbrowning of some foods. Dark pans are recommended for pies. Shiny pans are recommended for cakes, cookies and muffins.

### Bake time

A bake time setting may be added to most oven baking features. Use the bake time setting to start the oven immediately and to turn off automatically after the set bake time runs out.

#### To set bake using a default temperature of 350°F and to stop baking after 30 minutes:

- | Step                               | Press            |
|------------------------------------|------------------|
| 1. Press <b>bake time</b> .        | <b>bake time</b> |
| 2. Enter <b>3 0</b> minutes.       | <b>3 0</b>       |
| 3. Press <b>start</b> .            | <b>start</b>     |
| 4. Press <b>bake</b> .             | <b>bake</b>      |
| 5. Press <b>start</b> to activate. | <b>start</b>     |



To stop baking at any time press **cancel**.

#### When the set bake time runs out:

1. "**End**" will appear in the display window and the oven will shut-off automatically.
2. The control will beep 3 times every 30 seconds as a reminder until the **cancel** keypad is pressed.

### WARNING

**FOOD POISONING HAZARD.** Do not let food sit for more than one hour before or after cooking. Doing so can result in food poisoning or sickness.

### NOTES

- The maximum **bake time** setting is 6 hours.
- Whenever cooking with bake time settings, press **bake time** keypad once to momentarily display the remaining bake time.
- When bake is active with bake time settings you may remove the bake time instructions at anytime by setting a new bake time of **0:00**.
- **bake time** settings cannot be added when broiling or to the self-clean cycle.
- **bake time** settings may be added to **powerplus preheat** and the **convection** bake and roast features.

## SETTING OVEN CONTROLS

### Delay start

Use this keypad to add delay start time instructions for most timed cooking features or with the self-clean feature.

#### **WARNING**

**FOOD POISONING HAZARD.** Do not let food sit for more than one hour before or after cooking. Doing so can result in food poisoning or sickness.

#### **CAUTION**

Use caution when setting **bake time** or **delay start** instructions. Foods that can easily spoil such as milk, eggs, fish, meat or poultry, should be chilled in the refrigerator first. Even when chilled, they should not stand in the oven for more than 1 hour before cooking begins, and should be removed promptly when finished cooking.

**To program the oven for delay start and to shut-off automatically (example for baking at 375°F for 50 minutes and to start at 5:30):**

Step	Press
1. Press <b>bake time</b> .	bake time
2. Enter <b>50</b> minutes.	<b>5 0</b>
3. Press <b>start</b> .	start
4. Press <b>delay start</b> (See Fig. 1).	delay start
5. Enter <b>530</b> .	<b>5 3 0</b>
6. Press <b>start</b> .	start
7. Press <b>bake</b> .	bake
8. Enter <b>375</b> .	<b>3 7 5</b>
9. Press <b>start</b> to activate.	start

To stop cooking with delay start setting at any time press **cancel**.

### When the set bake time runs out:

1. "**End**" will appear in the display window and the oven will shut-off automatically (See Fig. 2).
2. The control will beep 3 times every 30 seconds as a reminder until the **cancel** keypad is pressed.



Fig. 1



Fig. 2

#### **NOTES**

- A **delay start** setting may be set with **self-clean**. The self-clean feature will not accept bake time instructions. Refer to the self-clean section for details on how to select different self-clean cycle times.
- The delay start setting may be added to the **powerplus preheat**, **convect** or **convect convert** features. A delay start setting cannot be added to **broil**.
- Once the **delay start** feature has started the cooking process, press the **bake time** keypad once to display any bake time remaining.

## SETTING OVEN CONTROLS

### Convect

#### Benefits of the convection features

- Foods cook more evenly
- Multiple rack baking
- No special pans or bakeware needed

The **convect** feature uses a fan to circulate the oven's heat uniformly around the oven. This improved heat distribution allows for fast, even cooking and browning results. Heated air flows around the food from all sides, sealing in juices and flavors. Convect provides better results when baking using multiple oven racks. Most foods cooked with a bake setting will cook faster and more evenly when using the **convect** features.

### Convect bake

#### Suggestions for convect baking

- For optimum results it is recommended to preheat the oven before baking foods such as cookies, biscuits and breads.
- Reduce the oven temperature 25°F from the recipe's recommended oven temperature. Follow the remainder of the recipe's instructions using the minimum recommended cook time.
- When using 2 oven racks at the same time, place in positions 2 & 5 for best results (Fig. 1).

#### To set convect bake with a default oven set temperature of 350°F:

Step	Press
1. Press <b>convect</b> .	<b>convect</b>
2. Press <b>start</b> .	<b>start</b>



To stop convect bake at any time press **cancel**.

### NOTES

- When using the convect features, any cook time reductions used may need to vary depending on the oven set temperature.
- When baking layer cakes, use the **bake** feature to obtain the best possible results.
- If the oven door is opened when a convect feature is active, the convect fan will stop rotating until the oven door is closed.

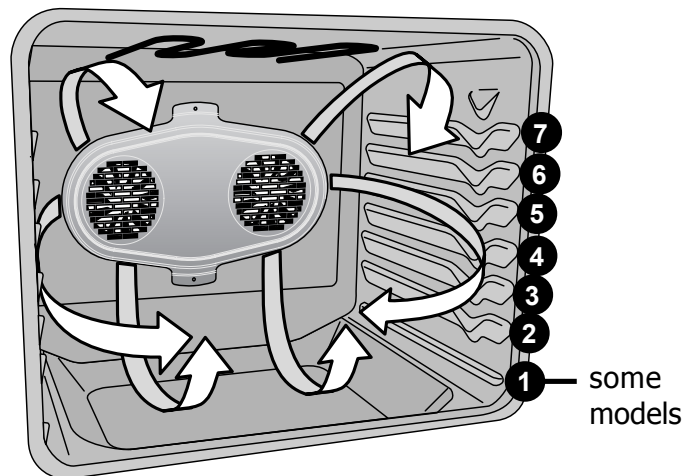

Fig. 1

### Convect roast

#### Suggestions for convect roasting

- Preheating is not necessary when roasting foods using **convect roast**.
- Since **convect roast** cooks faster, reduce cook times by 25% from the recommended time of your recipe (check the food at this time). Then if needed, increase cook time until the desired doneness is obtained.
- Do not cover foods when dry roasting - this will prevent the meat from browning properly.

#### To set convect roast with a default oven set temperature of 350°F:

Step	Press
1. Press <b>convect</b> .	<b>convect</b>
2. Press <b>convect</b> again.	<b>convect</b>
3. Press <b>start</b> .	<b>start</b>



To stop convect roast at any time press **cancel**.

### NOTE

When selecting the different convect features, use the **convect** keypad to toggle between the choices.



## SETTING OVEN CONTROLS

### Convect broil (some models)

Use the convect broil feature to cook thicker cuts of meats that require direct exposure to radiant heat and the convect fan for optimum broiling results.

#### IMPORTANT

Some models are not equipped with the **convect broil** feature.

#### Suggestions for convect broil:

1. Be sure to carefully follow all the recommended broil pan and insert instructions and the directions for placing the oven racks as provided in the "broil" section in this Use & Care Guide.
2. Since **convect broil** cooks food faster, reduce the cook time by 25% from the recommended cook time of your recipe (check the food at this time). If necessary, increase cook time until the desired doneness is obtained.
3. **Close the oven door** when using convect broil.

#### To set convect broil (some models) with a default oven set temperature of 550°F:

- | Step                                    | Press                  |
|---|------------------------|
| 1. Press <b>convect</b> keypad 3 times. | <b>convect</b> 3 times |
| 2. Press <b>start</b> to accept.        | <b>start</b>           |

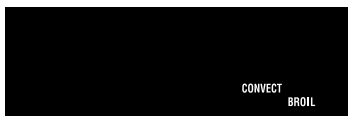

To stop convect broil at any time press **cancel**.

#### NOTE

The convect fan will begin rotating once convect broil has been activated (some models).

### Convect convert

The **convect convert** feature allows you to convert any baking recipe for the convect feature. The control uses the normal recipe settings and adjusts to a lower temperature for convection baking. The **convect convert** feature may only be used when convect baking.

#### To set convect using default oven set temperature of 350°F and adding the convect convert:

- | Step                              | Press                  |
|-----------------------------------|------------------------|
| 1. Press <b>convect</b> keypad.   | <b>convect</b>         |
| 2. Press <b>convect convert</b> . | <b>convect convert</b> |

To stop convect convert at any time press **cancel**.

When convect convert is active with a bake time or a delay start setting, the convect convert feature will display the message "CF" for **check food** when the bake time is 75% complete (See Fig. 1). At this time the oven control will sound 1 long beep at regular intervals until the set bake time has finished.

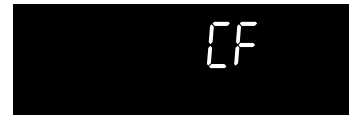

Fig. 1

#### NOTES

- When using convect convert, any cook time reductions needed may vary depending on the oven set temperature.
- When baking layer cakes, use the **bake** feature to obtain the best results.
- The minimum **bake time** setting allowed using the **convect convert** feature is 20 minutes.
- If the oven door is opened when a convect feature is active, the convect fan will stop rotating until the oven door is closed.

## SETTING OVEN CONTROLS

### Broil

Use the broil feature to cook meats that require direct exposure to radiant heat for optimum browning results. When broiling, always remember to arrange the oven racks while the oven is still cool.

#### To set broil:

##### Step

1. Arrange oven rack while cool (Figs.1 & 4). For optimum browning results, preheat the oven for about 5 minutes before adding food.
2. Be sure to place prepared food directly under upper oven element. Leave oven door open at the **broil stop** (Fig. 2) position.
3. Press **broil**.
4. Press **start** to activate.
5. Broil food on one side until browned. Turn and broil food on other side.

To stop broil at any time press **cancel**.

Press

broil

start

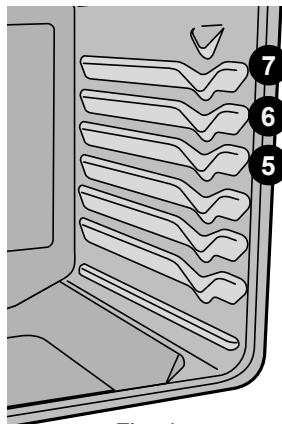

Fig. 1

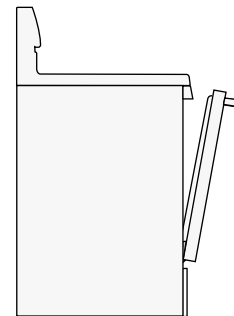
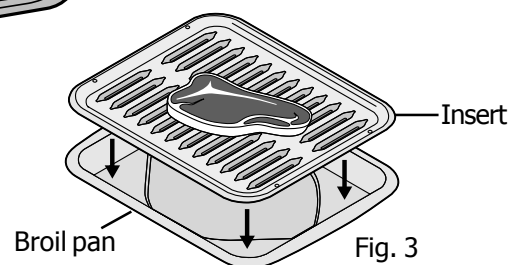

Fig. 2



### ! WARNING

Should an oven fire occur, close the oven door and turn the oven OFF. If the fire continues, use a fire extinguisher. **DO NOT** put water or flour on the fire. Flour may be explosive.

### 📌 NOTE

For better access to food while broiling, use oven mitts and pull the oven rack out to the rack stop position before turning or removing the food.

### 📌 NOTES

- If needed, lower the oven temperature to avoid over browning or drying of food items that should be cooked to the well-done stage.
- **bake time** or **start time** instructions cannot be added to the broil feature.
- When broiling the oven control does not provide a preheat indicator or reminder tone when the oven reaches set temperature.
- When broiling with a pan, be sure to use only Electrolux Home Products, Inc. approved broil pan & insert (Fig. 3).

### Suggested broil settings table (electric oven)

Food	Rack position	Setting	Cook time in minutes		Doneness
			1st side	2nd side	
Steak 1" thick	6th or 7th*	550°F	6	4	Medium
Steak 1" thick	6th or 7th*	550°F	7	5	Medium-well
Steak 1" thick	6th or 7th*	550°F	8	7	Well
Pork chops 3/4" thick	6th	550°F	8	6	Well
Chicken-bone in	5th	450°F	20	10	Well
Chicken-boneless	6th	450°F	8	6	Well
Fish	6th	550°F	- as directed -	-	Well
Shrimp	5th	550°F	- as directed -	-	Well
Hamburger 1" thick	7th*	550°F	9	7	Medium
Hamburger 1" thick	6th	550°F	10	8	Well

\*Use the off-set rack if you choose to use rack position 7.

Fig. 4

## SETTING OVEN CONTROLS

### Slow cook

The **slow cook** feature may be used to cook foods more slowly and at lower oven temperatures. Slow cook provides cooking results much the same way as a crock-pot or slow cooker.

The slow cook feature is ideal for roasting beef, pork & poultry. Slow cooking meats may result in the exterior of meats becoming dark but not burnt. This is normal.

Two settings are available for slow cook, high (Hi) or low (Lo). The high setting is best for cooking foods from a 4 to 5 hour time period. The low setting is best for cooking foods from a 8 to 9 hour time period.

#### Some tips for best results when using Slow Cook:

- Completely thaw all frozen foods before cooking with the slow cook feature.
- When using a single oven rack, place in oven rack position 2 or 3.
- Position multiple racks to accommodate the size of cooking utensils when cooking multiple food items at the same time.
- Do not open the oven door often or leave the door open when checking foods. If enough oven heat escapes, the slow cook time may need to be extended.
- Cover foods to keep them moist or use a loose or vented type cover to allow foods to turn crisp or brown.
- Roasts may be left uncovered so browning can occur. Cook times will likely vary; depending on the weight, fat content, bone and the shape of the roast.
- Use the recipe's recommended food temperature and a food thermometer to determine when the food is done.
- Preheating the oven will not be necessary when using the **slow cook** feature.
- Add any cream or cheese sauces during the last hour of cooking.

#### To set slow cook:

##### Step

Press

1. Position oven racks and cookware in oven. Close the oven door.
2. Press slow cook keypad. **Hi** will appear in the oven display indicating the default setting is for high. If a low setting is needed, press slow cook keypad again to select the **Lo** setting.
3. Press **start** to activate.

**slow  
cook**

**start**

To stop slow cook at any time press **cancel**.

### WARNING

**FOOD POISONING HAZARD.** Do not let food sit for more than one hour before or after cooking. Doing so can result in food poisoning or sickness. Foods that can easily spoil such as milk, eggs, fish, meat or poultry, should be chilled in the refrigerator first. Even when chilled, they should not stand in the oven for more than 1 hour before cooking begins, and should be removed promptly when finished cooking.

## SETTING OVEN CONTROLS

### Setting pizza feature

For your convenience the pizza feature provides 2 different settings. You may use the pizza feature whether starting with fresh or frozen pizza.

#### To set the pizza feature:

- | Step   | Press        |
|--|--------------|
| 1. Press <b>pizza</b> once to cook frozen pizza (Fig.1) or twice when setting for fresh pizza (Fig. 2). You may adjust the oven temperature to fit your needs. | <b>pizza</b> |
| 2. Press <b>start</b> .  | <b>start</b> |

To stop pizza feature at any time press **cancel**.

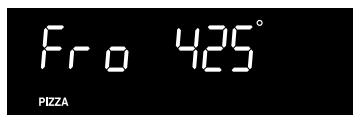

Fig. 1

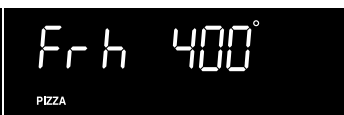

Fig. 2

### NOTES

- Use only one oven rack for best results with the pizza feature.
- The pizza feature is not timed. Be sure to monitor the time needed to finish cooking the pizza. Follow package directions for baking time. Check pizza at the minimum recommended time.
- The preset oven temperature for the frozen pizza setting is 425°F and the fresh pizza is 400°F.

### Setting keep warm

The keep warm feature will keep oven cooked foods warm for serving up to 3 hours. After 3 hours the keep warm feature will automatically turn OFF.

The keep warm feature may be used independently. This feature may also be set as a "trailing" keep warm.

### WARNING

**FOOD POISONING HAZARD.** Do not let food sit for more than one hour before or after cooking. Doing so can result in food poisoning or sickness.

#### To set oven for keep warm:

- | Step                        | Press            |
|-----------------------------|------------------|
| 1. Press <b>keep warm</b> . | <b>keep warm</b> |
| 2. Press <b>start</b> .     | <b>start</b>     |
- "HLd" for hold will appear in the display (Fig. 3).



Fig. 3

To stop keep warm at any time press **cancel**.

#### To set to bake for 30 minutes with the default temperature of 350°F; after baking the keep warm feature will automatically activate:

- | Step   | Press            |
|--|------------------|
| 1. Press <b>bake time</b> .                      | <b>bake time</b> |
| 2. Enter <b>30</b> minutes.                      | <b>3 0</b>       |
| 3. Press <b>start</b> .                          | <b>start</b>     |
| 4. Press <b>bake</b> .                           | <b>bake</b>      |
| 5. Press <b>start</b> to activate.               | <b>start</b>     |
| 6. After bake is active press <b>keep warm</b> . | <b>keep warm</b> |
| 7. To accept, press <b>start</b> .               | <b>start</b>     |

### NOTES

- Once activated, the **keep warm** feature will automatically turn OFF after 3 hours.
- If a **keep warm** setting is added to bake as a "trailing" keep warm for example, the setting must include bake time instructions.

## SETTING OVEN CONTROLS

### Setting my favorite

The **my favorite** keypad may be used to store and recall a favorite recipe setting. This feature will only store or recall one favorite recipe at a time.

My favorite feature may be used with bake, cook time, preheat, convect bake & roast, pizza (some models) and keep warm cooking features. This feature will not work with any other feature including delay start, broil or self-clean.

#### To save a favorite recipe setting (example shown to bake for 30 minutes with oven temperature of 325°F):

Step	Press
1. Press <b>bake time</b> .	bake time
2. Enter <b>30</b> minutes.	<b>3 0</b>
3. Press <b>start</b> .	<b>start</b>
4. Press <b>bake</b> .	<b>bake</b>
5. Enter <b>325</b> oven temperature.	<b>3 2 5</b>
6. Press <b>start</b> .	<b>start</b>
7. To store, press and hold <b>my favorite</b> keypad for 3 seconds.	<b>my favorite</b>

If at this time you do not wish to start the oven with the newly stored recipe, be sure to press **cancel**.

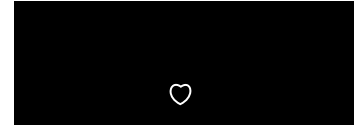

Fig.1

#### To recall a previously stored favorite recipe setting:

Step	Press
1. Press <b>my favorite</b> .	<b>my favorite</b>
2. Press <b>start</b> .	<b>start</b>

#### To erase a previously stored favorite recipe setting:

Step	Press
1. Press <b>my favorite</b> .	<b>my favorite</b>
2. Press <b>my favorite and hold</b>	<b>my favorite</b>

until the favorites icon disappears from the oven control display (See Fig. 1).

### NOTES

- If you do not wish the oven to turn ON after saving your recipe be sure to press **cancel** for your last step.
- **my favorite** feature stores or recalls only 1 recipe at any time.
- If a different recipe is needed, you may record a new recipe over the old by following the example provided for "To save a favorite recipe setting." Or you may clear any previously stored recipe before recording a new recipe by following the steps provided "To erase a previously stored favorite recipe setting."

## SETTING OVEN CONTROLS

### Adjusting the oven temperature

Your appliance has been factory calibrated and tested to ensure an accurate baking temperature. For the first few uses, follow your recipe times and temperature recommendations carefully. If you think the oven is cooking too hot or too cool for your recipe times, you can adjust the control so the oven cooks hotter or cooler than the temperature displayed.

The oven temperature may be increased +35°F (+19°C) or decreased -35°F (-19°C) from the factory settings.

#### Example: increase the oven temperature by 30°F:

Step	Press
1. Press and <b>hold bake</b> for 6 seconds.	<b>bake</b>
2. Enter 30.	<b>3 0</b>
3. To accept, press <b>start</b> .	<b>start</b>

#### Example: decrease the oven temperature by 30°F:

Step	Press
1. Press and <b>hold bake</b> for 6 seconds.	<b>bake</b>
2. Enter 30.	<b>3 0</b>
3. Press <b>self clean</b> .	<b>self clean</b>
4. To accept, press <b>start</b> .	<b>start</b>

### NOTES

- Oven temperature adjustments made will not affect the broil or self-cleaning feature temperatures.
- If the temperature shows an adjustment of -30°F, and a +30°F adjustment is needed, you can toggle between the (-) or (+) in the display by pressing **self clean**.
- DO NOT USE oven thermometers such as those found in grocery stores to check the temperature settings inside your oven. These oven thermometers may vary as much as 20 to 40 degrees from actual temperatures.

### Restoring to factory default settings

When new, your appliance was set with a few predetermined oven control settings. Over time, the user may make changes to these default settings.

The following functions or features have user programmable options or adjustments that may have been changed from the original default settings:

- **12 or 24 hour clock** display mode.
- **6-Hour Energy Savings** or **continuous bake** mode.
- **Silent** or **audible** keypad operation.
- Oven **temperature display** mode (F° or C°).
- Any oven **temperature offset** adjustment made.
- **Temp probe** options (some models).
- Any **stored favorite recipes** (some models).

### IMPORTANT

Before restoring the settings, please be aware that **all changes** made to the oven control settings will be erased once the start keypad is pressed. This includes any temperature offset made for the oven when baking.

#### To restore oven control to default settings:

Step	Press
1. Press <b>and hold 7</b> keypad until acceptance tone sounds (about 6 seconds).	<b>7</b>
2. To accept, press <b>start</b> .	<b>start</b>

### Operating the oven light

The interior oven light will automatically turn ON when the oven door is opened.

Press  to turn the interior oven light ON and OFF whenever the oven door is closed.

The interior oven light is located at the upper left rear wall of the oven interior and is covered with a glass shield held by a wire holder. The glass shield must be in place whenever the oven is in use.

To change the interior oven light, see "Changing the oven light" in the **Care & Cleaning** section.

## SETTING OVEN CONTROLS

### Setting the Sabbath feature (for use on the Jewish Sabbath & Holidays)



For further assistance, guidelines for proper usage and a complete list of models with the Sabbath feature, please visit the web at <http://www.star-k.org>.

### WARNING

**FOOD POISONING HAZARD.** Do not let food sit for more than one hour before or after cooking. Doing so can result in food poisoning or sickness.

The **bake time** and **delay start** keypads are used to set the Sabbath feature. The Sabbath feature may only be used with the **bake** feature. The oven temperature may be set higher or lower after setting the Sabbath feature (oven temperature adjustments should be used only during Jewish Holidays), however the display will not be visible and no audible tones will be provided when a change occurs.

Once the oven is properly set using the **bake** feature with the Sabbath mode active, the oven will remain continuously ON until cancelled. The Sabbath mode will override the factory preset 6-Hour Energy Saving feature.

If the oven light is needed during the Sabbath, turn on the **oven light before** activating the Sabbath feature. Once the oven light is turned on and the Sabbath feature is active, the oven light will remain on until the Sabbath feature is turned OFF. If the oven light needs to be off, be sure to turn the oven light off before activating the Sabbath feature.

It is recommended that any oven temperature change with the Sabbath feature active be followed with 2 presses of the **start** keypad. This will insure the oven remains ON even if the attempt to set the oven temperature was lower or higher than the oven control can accept. If the oven temperature is set incorrectly, the oven temperature will default to 170°F or 550°F. Try to set the desired oven temperature again.

### To program the oven for 350°F bake and activate the Sabbath feature:

- | Step  | Press                                 |
|---|---------------------------------------|
| 1. Be sure that the clock is set with the correct time of day.  |                                       |
| 2. Arrange the oven racks.  |                                       |
| 3. Press <b>bake</b> .  | <b>bake</b>                           |
| 4. Press <b>start</b> .   | <b>start</b>                          |
| 5. If a <b>bake time</b> or <b>delay start</b> is needed then enter the time in this step. If not, skip this step and continue to step 6. Refer to the <b>bake time</b> or <b>delay start</b> instructions. Remember the oven will shut-off after completing a <b>bake time</b> or <b>delay start</b> and therefore may only be used once during the Sabbath/Jewish Holidays. The maximum <b>delay start</b> time is 11 hours & 59 minutes. |                                       |
| 6. Press and <b>hold both the</b> <b>bake time</b> and <b>delay start</b> keypads for at least 3 seconds simultaneously. The control will beep and <b>SAb</b> will appear in the display (See Fig. 1). The oven is properly set for the Sabbath once <b>SAb</b> appears in the display.   | <b>bake time</b> + <b>delay start</b> |



Fig. 1

## SETTING OVEN CONTROLS

### Setting the Sabbath feature (cont'd)

To turn off the oven but keep the Sabbath feature active:

Press **cancel**. cancel

To turn off the Sabbath feature:

Press and hold both the bake time + delay start  
**bake time and delay start pads**  
**for at least 3 seconds**. The control will beep and **SAb** will disappear from the display. The oven is no longer programmed for the Sabbath feature.

**What to do during a power failure or power interruption after the Sabbath feature was activated:**

Should you experience a power failure or interruption, the oven will shut-off. When power is restored the oven will not turn back on automatically. The oven will remember that it is set for the Sabbath and the oven display will show the message "SF" for Sabbath failure (Fig. 1).

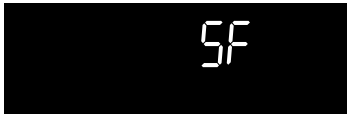

Fig. 1

The food may be safely removed from the oven while still in the Sabbath feature, however the oven cannot be turned back on until after the Sabbath/Holidays.

After the Sabbath observance turn OFF the Sabbath feature. At the same time **press and hold both** the

**bake time + delay start** keypads for at least 3 seconds.

**SF** will disappear from the display and the oven may be used with all normal functions.

### NOTES

- If a delay start time longer than 12 hours (maximum of 24 hours) is desired, set the display mode for the 24 hour setting. For detailed instructions see the section "Setting 12 or 24 hour display modes".
- It is not advised to attempt to activate any other program feature except **bake** while the Sabbath feature is active. ONLY the following keypads will function correctly with the Sabbath feature: **0-9 number keypads, bake, start & cancel**. All other keypads should not be used once the Sabbath feature is active.
- You may change the oven temperature once baking has started. Press **bake**, enter the oven temperature change (170 to 550F°) and press start (for Jewish Holidays only). Remember that the oven control **will no longer beep or display any further changes** once the oven is set for the Sabbath feature.
- If the **keep warm** feature was activated and the Sabbath feature was set the keep warm feature will automatically shut-off the oven after 3 hours.



## KEEP WARM DRAWER

### Keep warm drawer (some models)

The purpose of the keep warm drawer is to keep hot cooked foods at serving temperatures. It is not recommended to heat cold food in the keep warm drawer; always start with hot food.

The keep warm drawer may also be used to warm dinner plates. All food placed in the keep warm drawer should be covered with a lid or aluminum foil to maintain quality.

### Keep warm drawer indicator light

The keep warm drawer indicator light is located beside the **on-off** key. This indicator light will turn on when the keep warm drawer is active, and will stay on until the keep warm drawer is turned OFF.

*keep warm  
drawer* ■  
**on-off**

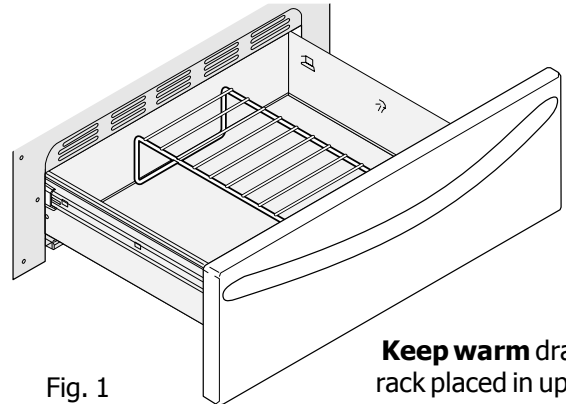

Fig. 1

**Keep warm** drawer rack placed in upright position.

### Arranging keep warm drawer rack positions

The keep warm drawer rack may be used in two ways:

- In the **upright position** to allow low profile food items to be placed both under and on top of the rack (for example, rolls or biscuits on top of the rack and a casserole dish underneath).
- In the **downward position** to allow you to place light weight food items and empty cookware (for example, rolls or pastries and dinner plates) on the rack.

Set the keep warm drawer rack in either position as shown below (Figs. 1 & 2).

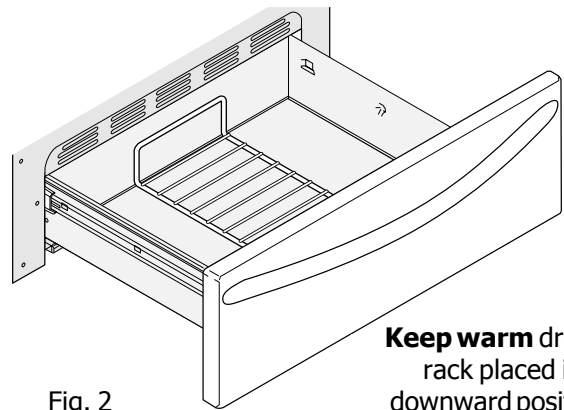

Fig. 2

**Keep warm** drawer rack placed in downward position.

### WARNING

- **Storage in or on appliance—flammable materials should not be stored in an oven, warmer drawer, near surface units.** This includes paper, plastic and cloth items, such as cookbooks, plasticware and towels, as well as flammable liquids. Do not store explosives, such as aerosol cans, on or near the range.
- **DO NOT LEAVE CHILDREN ALONE—children should not be left alone or unattended in the area where appliance is in use.** They should never be allowed to sit or stand on any part of the appliance, including the storage drawer (some models), warmer drawer (some models) or warmer oven (some models).

# KEEP WARM DRAWER

## Keep warm drawer (some models)

### Keep warm drawer recommended settings

Recommended keep warm drawer food settings are shown in Fig. 1. If a particular food is not listed, start with the **med** setting. If more crispness is desired, remove the lid or aluminum foil from the food.

Most foods can be kept at serving temperatures on the **med** setting. When a combination of foods are to be kept warm (for example, a meat with 2 vegetables and rolls) use the **hi** setting. To avoid heat loss, do not open the keep warm drawer often while in use.

Keep warm drawer recommended food settings	
Food Item	Setting
Bacon	hi
Hamburger patties	hi
Poultry	hi
Pork chops	hi
Fried foods	hi
Pizza	hi
Gravies	med
Casseroles	med
Eggs	med
Roasts (beef, pork or lamb)	med
Vegetables	med
Biscuits	med
Rolls (hard)	med
Pastries	med
Rolls (soft)	lo
Empty dinner plates	lo

Fig. 1

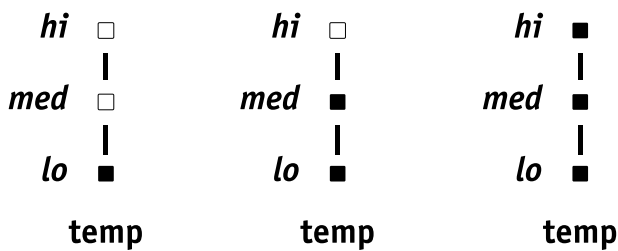

Fig. 2 -

Heat level indicator lights for keep warm drawer

### Operating keep warm drawer

The electronic control located on the left side of the control panel is used to turn ON and set temperature settings for the keep warm drawer. Available temperature settings are designated by **hi**, **med**, and **lo** and are approximate. If needed, refer to **keep warm drawer recommended settings** list provided in this section.

### CAUTION

Always use potholders or oven mitts when removing food from the warmer drawer as cookware and plates will be hot and you can be burned.

### To set the keep warm drawer:

- | Step   | Press         |
|--|---------------|
| 1. Arrange the keep warm drawer rack (if needed) in the keep warm drawer and place the food or dishes in the keep warm drawer. |               |
| 2. Press <b>on-off</b> for the keep warm drawer control.   | <b>on-off</b> |
| 3. Press <b>temp</b> keypad to select desired temperature setting (high, medium or low; Fig. 2).                               | <b>temp</b>   |
| 4. Once warming is finished, press <b>on-off</b> to turn OFF.  | <b>on-off</b> |

### IMPORTANT

**Do not use plastic wrap to cover food. Plastic may melt onto the drawer and be very difficult to clean up.** Use only utensils and cookware recommended by the manufacturer for use in the keep warm drawer.

### NOTES

- The keep warm drawer heating level may be adjusted anytime the keep warm drawer is active.
- The keep warm drawer will not operate whenever self-clean is active.

## Preparing for self-clean

A self-cleaning oven cleans itself using high temperatures that are well above normal cooking temperatures. The self-clean feature, if used properly, will eliminate soils from the oven completely or reduce them to a fine powdered ash. Once the oven has cooled, simply wipe away the ash using a damp cloth.

Your oven provides three self-cleaning duration choices. A 3-hour cleaning time for normal cleaning; a 2-hour clean for lighter soils and a 4-hour option for heavier burnt-on soils (some models).

### WARNING

- **Do not touch** the oven during the self-clean cycle.
- Keep children away from oven during self-clean cycle.
- Failure to follow these instructions can result in burns.

### CAUTION

The health of some birds is extremely sensitive to the fumes given off during the self-cleaning cycle of any range. Move birds to another well-ventilated room.

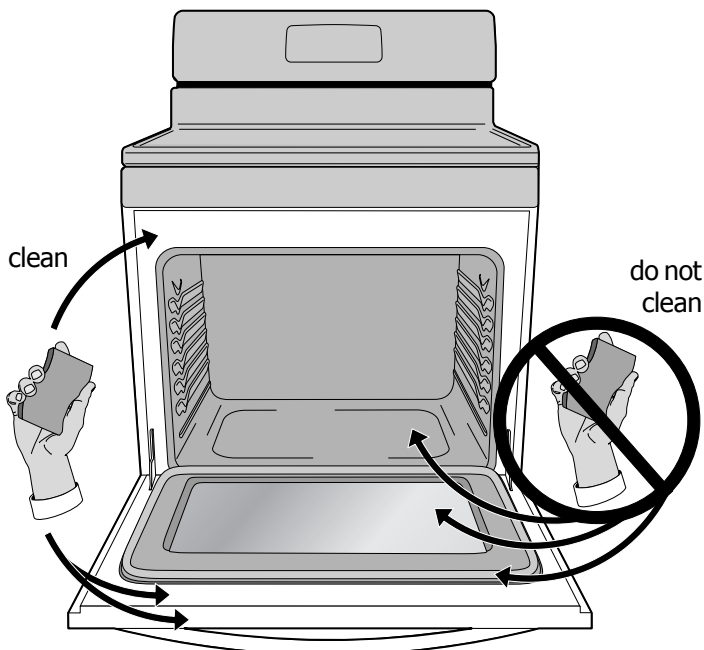

Fig. 1

## Read before starting self-clean

### IMPORTANT

- Remove **all items** from the oven and cooktop, including **food, cookware, utensils, plastic** and **any aluminum foil** and **temp probe** (if equipped). Aluminum foil will not withstand high temperatures generated during a self-clean cycle.
- Remove **all oven racks** and **any accessories** from the oven to avoid possible heat damage. If the oven racks are not removed they may discolor. The Effortless™ Oven Rack (some models) must be removed before starting self-clean to avoid damaging the glide ability of the rack.
- Be sure the **oven vent area is clear**.
- Remove **all items** from the storage drawer (some models) or warming drawer (some models).
- Be sure the oven light shield is in place. Turn off the oven light.
- **Remove any excessive spillovers.** Spills on the oven bottom should be wiped-up and removed **before starting self-clean**. To clean, use hot, soapy water and a cloth. Large food spillovers can cause heavy smoke or a fire during self-clean.
- Remove any food spills from oven that have a high sugar or acid content (such as milk, tomatoes, sauerkraut, fruit juices or pie filling) before starting a self-clean cycle. If they are not removed they may leave a dull spot even after self-cleaning.
- Clean any soil from the outer oven frame, the door liner outside the oven door gasket and the small area at the front center of the oven bottom. Clean using soap and water before starting self-clean. These areas (See Fig. 1) heat sufficiently to burn soil on.
- **Do not clean the oven door gasket** (See Fig. 1). Do not use any cleaning materials on the oven door gasket. Doing so could cause damage to the door gasket. The woven material of the oven door gasket is essential for a good seal. Care should be taken not to rub, damage or remove the gasket.
- **Do not** use commercial oven cleaners or protective coatings of any kind inside oven. Residue from oven cleaners may damage the porcelain during the next self-clean cycle.

## SELF-CLEANING

### Read before starting self-clean (cont'd)

#### IMPORTANT

- It is normal for odors to occur during self-clean, especially during the first self-clean cycle. It is recommended to ventilate the kitchen. Open any windows and if available turn on an exhaust fan or overhead range hood during the self-clean cycle.
- Be aware that during self-clean temperatures inside the oven will become hot enough to melt or destroy some types of materials, including cookware made with materials having a low melting point and **aluminum foil**.

### Setting a self-clean cycle

**Example: To start an immediate self-clean cycle:**

- | Step   | Press             |
|--|-------------------|
| 1. The oven should be empty and <b>all oven racks</b> removed. Remove all items from the cooktop. Be sure the oven door is <b>completely</b> closed.   |                   |
| 2. Press <b>self clean</b> once for a 3-hour clean time, press self clean twice for 4-hour clean and press 3 times for a 2-hour self-clean cycle time. | <b>self clean</b> |
| 3. Press <b>start</b> to activate.   | <b>start</b>      |
- Once the door has locked, "CLn" will appear in the display indicating the oven has started heating for the self-clean cycle (Fig. 2).
- Press **cancel** at any time to stop self-clean.



door Loc

Fig. 1



CLn

Fig. 2

#### IMPORTANT

After pressing start, the door lock motor will activate. "door Loc" will appear in the display (Fig. 1). **DO NOT** attempt to open the oven door when the "door Loc" message is displayed (allow about 15 seconds for the oven door to completely lock). **DO NOT** force the oven door open. This may damage the automatic door locking system.

#### CAUTION

To avoid possible burns use caution when opening the oven door when the self-clean cycle is finished. The oven may still be **VERY HOT**. **Stand to the side of the oven** when opening the door to allow hot air or steam to escape.

#### When the self-clean cycle is done:

1. The time of day and "Hot" will show in the display (See Fig.3).
2. Once the oven has cooled (about 1 hour) and "Hot" is no longer displayed the "door OPn" message will appear (Fig. 4). When this message turns off the door is finished unlocking. Use **caution** and avoid possible burns when opening the door after the self-cleaning cycle. The oven may still be **VERY HOT**.



Hot

Fig. 3



door OPn

Fig. 4

#### NOTES

- Whenever the self-clean feature is active you may check the amount of clean time remaining by pressing the **self clean** keypad once. The oven door will remain locked until the range has cooled sufficiently. You will need to allow about **1 additional hour** to the time displayed before you can open the oven door.
- When the oven is cool, wipe away any residue or powdered ash from the oven interior using a damp cloth or paper towel.

## If it becomes necessary to cancel self-clean:

1. Press **cancel** keypad.
2. If the self-clean cycle has heated the oven to a high temperature, the "**Hot**" (Fig. 1) message will show in the display. Allow enough time for the oven to cool and for the "**door OPn**" message to display (Fig. 2). When this message turns off the oven door may be opened.

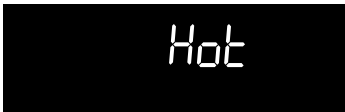

Fig. 1

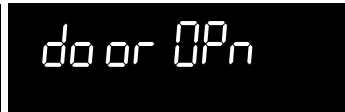

Fig. 2

## Restarting a self-clean cycle after a power outage:

If a self-clean cycle was interrupted by a power failure, your oven may not have thoroughly cleaned. If so, once power is restored, the oven has cooled and the oven door has unlocked, if needed, set for another self-clean cycle.

## Starting another self-clean after cancellation:

If self-clean was cancelled manually shortly after being started, and the oven interior did not reach high self-clean temperatures, the next clean cycle may be set as soon as the oven door unlocks from the cancelled clean cycle.

If the oven became hot enough from the cancelled self-clean cycle, you may be required to wait up to 4 hours before the control will allow another self-clean cycle to start.

### NOTE

If setting "back to back" self-clean cycles, the control may display the messages "**CLEAN**", then "**dELAY**" followed by the length of time to wait before the next self-clean may be set. For example, if the message displayed reads "**4:00**", the control will not allow self-clean to be set until 4 hours later.

## Setting a delay start self-clean cycle

**Example: To program a self-cleaning cycle with a delay start time of 9:00 o'clock:**

- | Step   | Press              |
|--|--------------------|
| 1. The oven should be empty and <b>all oven racks</b> removed. Remove all items from the cooktop. Be sure the oven door is <b>completely</b> closed.   |                    |
| 2. Press <b>delay start</b> .  | <b>delay start</b> |
| 3. Enter <b>9 0 0</b> .  | <b>9 0 0</b>       |
| 4. Press <b>start</b> .  | <b>start</b>       |
| 5. Press <b>self clean</b> once for a 3-hour clean time, press self clean twice for 4-hour clean and press 3 times for a 2-hour self-clean cycle time. | <b>self clean</b>  |
| 6. Press <b>start</b> to accept.   | <b>start</b>       |
- Press **cancel** at any time to stop self-clean.

### NOTES

- The maximum **delay start** setting is 11 hours & 59 minutes.
- Check to be sure the oven is **empty** before setting a self-clean cycle. Immediately after setting self-clean with a **delay start** setting the oven door will lock. The self-clean feature will not start heating the oven for cleaning until reaching the delay start time.

## CARE & CLEANING

### Cleaning recommendation table

Surface type	Recommendation
<ul style="list-style-type: none"> <li>• <b>Control knobs</b> (some models)</li> <li>• <b>Painted body parts</b></li> <li>• <b>Painted decorative trim</b></li> <li>• <b>Aluminum, plastic or vinyl trim pieces</b></li> </ul>	<p>For general cleaning, use hot, soapy water and a cloth. For more difficult soils and built-up grease, apply a liquid detergent directly onto the soil. Leave on soil for 30-60 minutes. Rinse with a damp cloth and dry. Do not use abrasive cleaners on any of these materials; they can scratch. To remove control knobs, turn to OFF position; grasp firmly and pull straight off the shaft. To replace knobs after cleaning, line up the flat sides of both knob and shaft; then push knob into place.</p>
<ul style="list-style-type: none"> <li>• <b>Control panel</b></li> <li>• <b>Control key pad membrane</b></li> <li>• <b>Decorative trim</b> (some models)</li> </ul>	<p>Before cleaning the control panel, turn all controls OFF, activate oven lockout (on some models) and if needed remove any knobs from panel. Do not use abrasive cleaners on any of these materials; they can scratch. Clean using hot, soapy water and a dishcloth. Be sure to squeeze excess water from dishcloth before wiping control panel; especially when wiping around the controls area. Excess water in or around the controls may cause damage to the appliance. When rinsing, use clean water and a dishcloth and be sure to squeeze excess water from dishcloth before wiping the control panel.</p>
<ul style="list-style-type: none"> <li>• <b>Easy Care™ stainless steel</b> (some models)</li> </ul>	<p>If your range finish is <b>Easy Care™ stainless steel</b> (some models), clean the stainless with warm soapy water using a clean sponge or cloth. Rinse with clean water and dry with a soft clean cloth. <b>DO NOT</b> use <b>ANY</b> store bought cleaners like stainless steel cleaners or any other types of cleaners containing any abrasive, chloride, chlorine or ammonia. It is recommended to use mild dish soap and water or a 50/50 solution of water and vinegar.</p>
<ul style="list-style-type: none"> <li>• <b>Porcelain enamel parts, door liner &amp; body parts.</b></li> <li>• <b>Keep warm drawer interior</b> (some models)</li> <li>• <b>Storage drawer interior</b> (some models)</li> </ul>	<p>Gentle scrubbing with a soapy no-scratch cleaning pad will remove most spots. Rinse with a 1:1 solution of clear water and ammonia. If necessary, cover difficult spots with an ammonia-soaked paper towel for 30 to 40 minutes. Rinse with clean water and a damp cloth, and then scrub with a soap-filled no-scratch cleaning pad. Rinse and wipe dry with a clean cloth. Do not allow food spills with high sugar or acid content (milk, tomatoes, sauerkraut, fruit juices or pie filling) to remain on the surface; they may cause a dull spot even after cleaning.</p>
<ul style="list-style-type: none"> <li>• <b>Oven interior</b></li> </ul>	<p>Remove excessive spillovers from oven cavity bottom <b>before starting self-clean</b>. Clean any soils from oven frame and door liner outside the oven door gasket. For very important preparation information be sure to read all the instructions in the self-cleaning section.</p>
<ul style="list-style-type: none"> <li>• <b>Oven racks</b></li> </ul>	<p><b>Oven racks must be removed from oven. Do not clean oven racks in oven during the self-clean cycle.</b> Remove and clean using a mild, abrasive cleaner following manufacturer's instructions. Thoroughly rinse and dry.</p>
<ul style="list-style-type: none"> <li>• <b>Oven door</b></li> </ul>	<p>Use soap &amp; water to thoroughly clean the top, sides and front of the oven door. Rinse well. You may use a glass cleaner on the outside glass of the oven door. <b>Do not</b> immerse the door in water. <b>Do not spray or allow water or the glass cleaner to enter the door vents.</b> Do not use oven cleaners, cleaning powders or any harsh abrasive cleaning materials on the outside of the oven door. <b>Do not</b> clean the oven door gasket. On self-cleaning models the oven door gasket is made of a woven material which is essential for a good seal. Care should be taken not to rub, damage or remove this gasket.</p>
<ul style="list-style-type: none"> <li>• <b>Ceramic cooktop</b></li> </ul>	<p>Refer to "Cooktop maintenance" and "Cooktop cleaning" in the <b>Care &amp; Cleaning</b> section.</p>

## Cooktop maintenance

### ➔ IMPORTANT

**Consistent and proper cleaning is essential to maintaining your ceramic glass cooktop.**

Prior to using your cooktop for the first time, apply some of the glass-ceramic cooktop cleaner supplied with your new appliance. Buff with a **non-abrasive** cloth or no-scratch cleaning pad. This will make cleaning easier when soiled from cooking. The special cooktop cleaning cream leaves a protective finish on the glass to help prevent scratches and abrasions.

Sliding aluminum or copper clad bottom pans on the cooktop can cause metal markings on the cooktop surface. These marks should be removed **immediately** after the cooktop has cooled using the cooktop cleaning cream. Metal marks can become permanent if not removed prior to future use.

Cookware (with cast iron, metal, ceramic or glass) with rough or dirty bottoms can **mark or scratch** the cooktop surface.

#### Do not:

- Slide anything metal or glass across the cooktop.
- Use cookware with dirt or dirt build up on bottom; replace with clean cookware before using.
- Use your cooktop as a cutting board or work surface in the kitchen.
- Cook foods directly on the cooktop surface or without using cookware.
- Drop heavy or hard objects on the ceramic glass cooktop, they may cause it to crack.

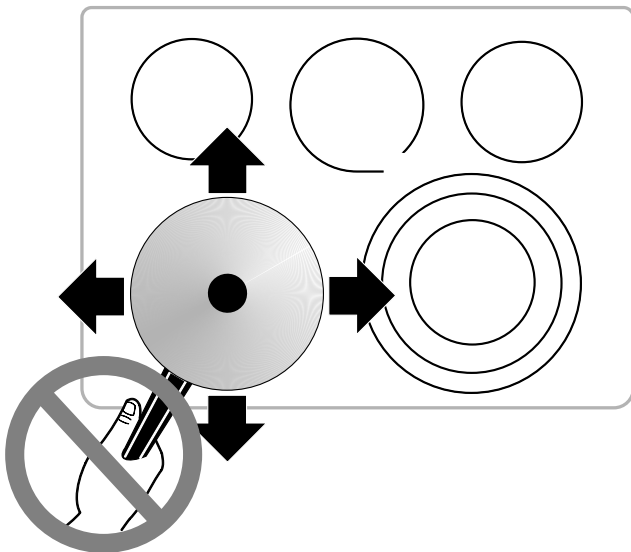

## Cooktop cleaning

### ⚠ CAUTION

Before cleaning the cooktop, be sure the controls are turned to OFF and the cooktop is COOL.

#### For light to moderate soil:

Apply a few drops of glass-ceramic cooktop cleaner directly to the cooktop. Use a paper towel or use a non-abrasive plastic type no-scratch cleaning pad to clean the entire cooktop surface. Make sure the cooktop is cleaned thoroughly, leaving no residue.

#### For heavy, burned on soil:

Apply a few drops of glass-ceramic cooktop cleaner directly to the soiled area. Rub the soiled area using a non-abrasive plastic type no-scratch cleaning pad, applying pressure as needed. Do not use the pad you use to clean the cooktop for any other purpose.

If soils remain, carefully scrape soils with a metal razor blade scraper, holding scraper at a 30 degree angle to the surface. Remove loosened soils with cooktop cleaning cream and buff surface clean.

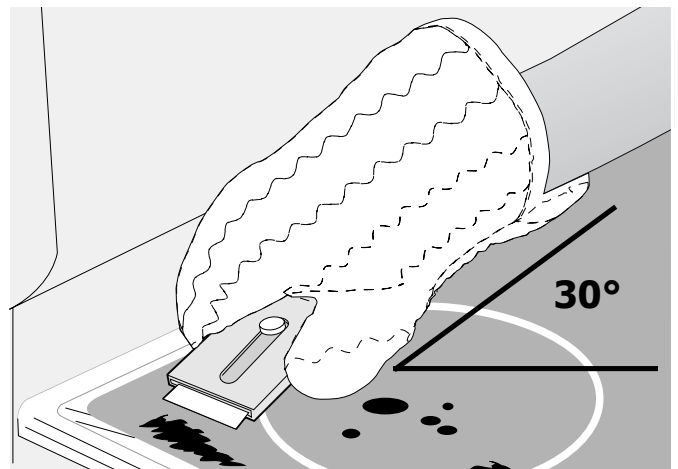

#### Plastic or foods with a high sugar content:

These types of soils need be removed immediately if spilled or melted onto the ceramic cooktop surface. Permanent damage (such as pitting of the cooktop surface) may occur if not removed **immediately**.

After turning the surface elements OFF, use a razor blade scraper or a metal spatula with a mitt (as illustrated) and scrape the soil from the hot surface. Allow the cooktop to cool, and use the same method for heavy or burned on soils.

## CARE & CLEANING

### Cooktop cleaning (cont'd)

#### **! WARNING**

**DO NOT use a cooktop cleaner on a hot cooktop. The fumes can be hazardous to your health and can chemically damage the ceramic glass surface.**

#### **Do not use the following on the cooktop:**

- Do not use abrasive cleaners and scouring pads, such as metal and some nylon pads. They may scratch the cooktop, making it more difficult to clean.
- Do not use harsh cleaners, such as chlorine bleach, ammonia or oven cleaners, as they may etch or discolor the cooktop.
- Do not use dirty sponges, cloths or paper towels, as they can leave soil or lint on the cooktop which can burn and cause discoloration.



### Aluminum foil and oven liners

#### **! WARNING**

**Protective liners**—Do not use aluminum foil to line the oven bottom. Only use aluminum foil as recommended in this manual. Improper installation of these liners may result in risk of electric shock, or fire.

### Aluminum foil and oven liners (cont'd)

Do not use oven bottom liners or use aluminum foil to cover the oven bottom or any oven racks.

Using a liner in the oven restricts the heat and air flow needed to obtain the best possible cooking results for any oven, including the warmer drawer (on some models).



During self-clean the oven temperature can become hot enough to melt aluminum cooking utensils or aluminum foil if left in the oven. This could result in **permanent damage** to the oven interior porcelain finish.

### Replacing the oven light

#### **! CAUTION**

Be sure the range is unplugged and all parts are **COOL** before replacing oven light. Wear a leather-faced glove for protection against possible broken glass.

The interior oven light is located at the rear oven cavity and is covered with a glass shield. The glass shield must be in place whenever the oven is in use (See Fig. 1).

#### **Replacing the oven interior light bulb:**

1. Turn electrical power off at the main source or unplug the appliance.
2. Remove interior oven light shield (See Fig. 1).
3. Replace bulb with a new **T-4 type 40 Watt Halogen** appliance bulb. Please note: do not allow your fingers to touch the new bulb when replacing. This will shorten the life of the bulb. Use a paper towel while handling the new bulb when installing.
4. Replace glass oven light shield.
5. Turn power back on again at the main source (or plug the appliance back in).
6. Be sure to reset the time of day on the clock.

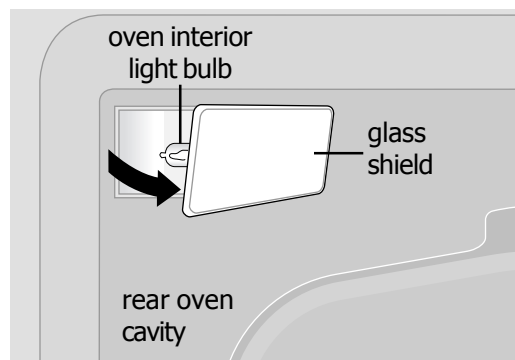

Fig. 1



### Removing and replacing the lift-off oven door

#### **CAUTION**

- To avoid possible injury when removing or replacing the oven door, follow the instructions below carefully and always hold the oven door with both hands positioned away from the door hinge area.
- The oven door is heavy. For safe, temporary storage, lay the door flat with the inside of the door facing down.

#### To remove oven door:

1. Open oven door completely (horizontal with floor - See Fig. 1).
2. Pull the door hinge locks on both left and right door hinges down from the oven frame completely towards the oven door to unlock (See Fig. 2). A tool such as a small flat-blade screwdriver may be required.
3. Firmly grasp both sides of oven door along the door sides (Do not use the oven door handle).
4. Close the door to the broil stop position. The oven door will stop into this position just before fully closing.
5. With the oven door in the broil stop position (Fig. 3), slightly lift and carefully pull the oven door away from the oven frame. To avoid finish damage, be careful not to allow the oven door hinges to contact the oven front frame.

#### To replace oven door:

1. Firmly grasp both sides of oven door along the door sides (Do not use the oven door handle).
2. Holding the oven door at the same angle as the removal position (See Fig. 3), carefully line up and insert both door hinge arms between the pins located on each side of the oven door frame (See Fig. 4).
3. With both door hinge arms in place, open the oven door (horizontal with floor - See Fig. 1).
4. Push the door hinge locks up towards and into the oven frame for both left and right oven door hinges to the locked position (See Fig. 2).
5. Close the oven door.

#### Special door care instructions - Most oven doors contain glass that can break. Read the following recommendations:

1. **Do not** close the oven door until all the oven racks are fully positioned into the oven interior.
2. Do not hit the glass with pots, pans, or any other object.
3. Scratching, hitting, jarring or stressing the glass may weaken its structure causing an increased risk of breakage at a later time.

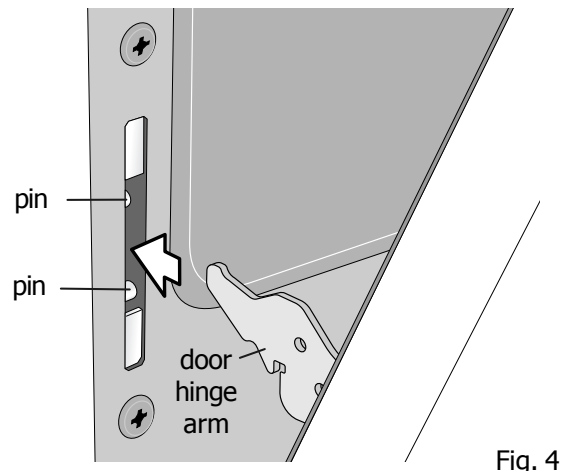
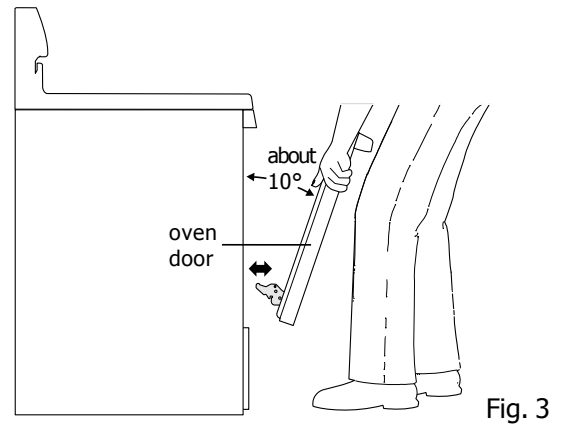
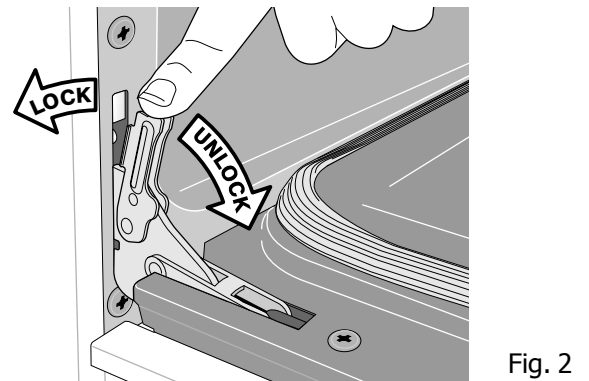
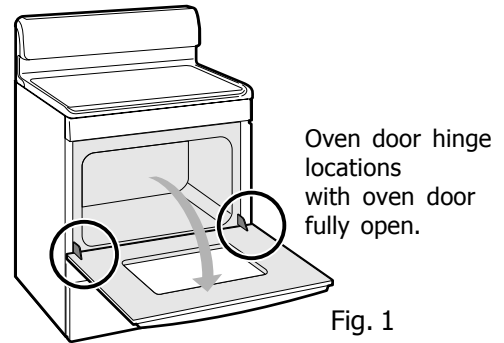

## BEFORE YOU CALL • Solutions to common problems

Problem	Possible Causes	Solutions
Display flashes time.	Power interruption.	Press <b>cancel</b> then set the correct time of day.
Oven control displays <b>F__</b> (followed with a number) and oven control beeps.	The oven control has detected a fault or error condition.	Press <b>cancel</b> to clear the display & stop beeping. Try bake or broil feature again. If the F code error repeats, remove electric power from appliance, wait 5 minutes and then <b>repower</b> appliance and set clock. Try bake or broil feature again.
	Error condition recurs.	Record fault code and call your authorized service agent.
The oven does not respond or error tone sounds when a keypad is pressed.	Pressed outside keypad area.	Be sure to press center of keypad using flat portion of finger.
	Lock feature may be active.	Cancel the lock feature (some models).
	No electric service.	See "Entire appliance does not operate" in this checklist.
New oven cooks hotter or cooler than previous experience.	Difference in oven temperature settings between the old and new range.	For the first few uses, follow your recipe times and temperature recommendations carefully. If you feel the oven is too hot or cool from your previous cooking experience, try offsetting the oven temperature. See "Adjusting the oven temperature" in <b>Setting Oven Controls</b> section.
Odor or some smoking coming from the oven during first few uses.	New appliance.	It is possible to experience some odors and/or a small amount of smoke from a new range. The odor will diminish after first using the oven. Before cooking for the first time, turn the oven ON to 400°F for 30 minutes to one hour. This will allow for an initial burn-in period and help eliminate odors. If necessary, ventilate the kitchen by opening a window.
Appliance makes popping sounds.	Oven expands and contracts while heating and self-clean.	This is normal while the oven heats to temperature or cools down.
Control panel makes clicking noises.	The oven control is cycling the oven ON and OFF.	This is normal when the oven is active.
Warm air or steam from oven vent area.	Moisture coming from food while cooking in oven.	This is normal. To ensure the best possible results, <b>do not block the oven vent</b> area when cooking.
Poor baking or roasting results.	Incorrect oven control setting.	See <b>Setting Oven Controls</b> section and review instructions for the desired cooking function.
	Oven vent may be blocked.	Clear any cookware or items that is blocking the oven vent area.
	Incorrect cookware type or size.	Dark or dull pans absorb more heat than shiny bakeware resulting in overbrowning of some foods. Try reducing the oven temperature or cook time to prevent overbrowning. Dark pans are recommended for pies; shiny pans for cakes, cookies and muffins.
	Baking started with cold oven.	Try preheating the oven before placing food on oven rack.
	Incorrect oven rack position.	Adjust oven rack position upward or downward as needed.
	Inadequate space around cookware or air flow is blocked by oven liner or using aluminum foil as a liner.	Try centering food in oven for single items. When cooking multiple food items space cookware to allow air to circulate completely around the food items. Review section for "Aluminum foil and liners" in the <b>Care &amp; Cleaning</b> section.
	Oven temperature or time settings.	Try adjusting the recipe's recommended temperature or cooking time. If you still feel the oven is too hot or cool, try offsetting the oven temperature. See "Adjusting the oven temperature" in <b>Setting Oven Controls</b> section.

<b>Problem</b>	<b>Possible Causes</b>	<b>Solutions</b>
Oven portion of appliance does not operate.	Incorrect oven control setting.	Be sure the oven control was set correctly for the requested feature. See <b>Setting Oven Controls</b> section and review instructions for the desired cooking function in this manual or see "Entire appliance does not operate" in this checklist.
	Lock feature may be active.	Cancel the lock feature (some models).
Entire appliance does not operate.	Power supply to appliance disconnected or electrical power outage.	Be sure appliance power cord is plugged properly to electrical outlet. Check house circuit breaker; reset if needed. If the electric service to the house is out, call your local electric utility for service.
	Service wiring is incomplete.	Contact your dealer, installing agent or authorized service agent for assistance.
Range is not level.	Floor is not level, weak or unstable.	If floor under range is sagging or sloping, contact a carpenter to correct the problem.
	The cooktop or oven racks are not level.	To correct, place oven rack in center of oven. Place a bubble (or spirit) level centered on the oven rack. Adjust by turning leveling legs at bottom of range until the oven rack rests level.
	Cabinet alignment may make range appear not level.	Be sure kitchen cabinets are square & have sufficient room for appliance clearance.
Cannot move appliance easily. Appliance must be accessible for service.	Carpet interferes with range.	Provide sufficient space so appliance may be lifted over carpet.
	Cabinets are built in too tightly to appliance sides.	Contact builder or installer to make appliance accessible.
Convect fan makes noise (some models).	The convect fan may turn ON or OFF automatically.	This is normal. On some cooking features the convect fan may run until the feature is done or the door was opened or closed.
Convect fan turns ON and OFF while cooking (some models).	Oven door is open.	The convect fan will turn OFF if the oven door is opened while any convect feature is active. Close oven door.
Convect fan turns on with features that should run without a fan (some models).	For some models the convect fan may turn ON while preheating.	This is normal (some models).
Oven control displays " <b>Prob ERR</b> ". The probe is not recognized by the oven control (some models).	The probe is not fully inserted into the probe receptacle.	Double check that the temp probe is fully inserted into probe receptacle. Use only the probe originally supplied with range.
	If the error code persists, the probe may be damaged or the probe cable has a short.	Remove the <b>probe</b> from receptacle and oven. The oven may still be used normally without the probe. Call your authorized service agent for a replacement probe.

## BEFORE YOU CALL • Solutions to common problems

Problem	Possible Causes	Solutions
<b>bake</b> or <b>self-clean</b> did not start at the time expected.	The time of day is incorrect.	Set clock with correct time of day before adding a delay start setting. See "Setting the clock" in <b>Setting Oven Controls</b> section.
Strong odor from range or smells hot.	Self-clean was started for the first times.	It is normal for odors to occur during self-clean, especially during the first self-clean cycle. It is recommend to ventilate the kitchen area. Open any windows and if available turn on an exhaust fan or overhead range hood during the self-clean cycle.
Unable to remove items from oven after starting self-clean.	Oven door locks immediately after setting self-clean.	Press <b>cancel</b> to stop self-clean. Wait for the oven door to unlock. Once unlocked, remove any items left in the oven, close the oven door and set for self-clean again.
Oven door did not unlock immediately after self-clean cycle.	Oven is still too hot.	Allow about 1 hour after the self-clean cycle for the oven to cool enough before the oven door will unlock.
Self-clean feature will not start.	Incorrect control setting.	Carefully follow the preparation and programming instructions under <b>Self-cleaning</b> .
	Oven door open.	The oven door must lock before the self-clean cycle will start. Be sure the oven door is closed before starting self-clean.
Self-clean will not restart after being cancelled.	The control has determined oven is too hot to restart self-clean (some models).	In some cases after cancelling self-clean, you may be required to wait up to 4 hours before the self-clean feature may be used again. Watch display for any messages.
Soil not completely removed after self-cleaning cycle.	Heavy soils. Clean time too short or spillovers were left inside oven.	Set self-clean feature for maximum cleaning time. Remove any excessive spillovers from oven <b>before starting self-clean</b> . Carefully follow preparation instructions under "Self-cleaning".
	Failure to clean soil from the oven frame, the door liner outside the oven door gasket and the small area at the front center of the oven bottom.	These areas are not within the self-cleaning area, but get hot enough to burn on residue. Clean these areas before starting a self-clean cycle. Burned-on residue may be cleaned with a stiff nylon brush and water or a nylon scrubber. Be careful not to damage the oven gasket.
	Interrupted by power outage.	Once power is restored restart self-clean.
Powdered ash inside the oven cavity after self-clean cycle.	This is normal. The temperature of the self-clean feature turned dirt to ash.	Wait for the oven to <b>completely</b> cool. Wipe away any residue or powdered ash from the oven interior using a clean damp cloth or paper towel.
Oven rack finish is dull or discoloring.	Oven racks left inside oven during self-clean.	Remove <b>all oven racks</b> from oven before starting self-clean. Clean after removing from the oven using a mild, abrasive cleaner following manufacturer's instructions. Thoroughly rinse and dry.
Oven rack no longer slides in or out of oven easily.	Oven racks left inside oven during self-clean.	Remove <b>all oven racks</b> from oven before starting self-clean. To ease rack movement, remove from oven and clean if needed. Then apply a small amount of vegetable oil to a paper towel and wipe oil on edges of oven racks. Do not use lubricant sprays.

Solutions to common problems • **BEFORE YOU CALL**

<b>Problem</b>	<b>Possible Causes</b>	<b>Solutions</b>
Oven smokes excessively when broiling.	Oven door was closed.	Be sure oven door is open when broiling.
	Meat too close to upper element.	Reposition oven rack lower to provide proper clearance between the food & the upper element.
	Meat not prepared for broil.	Remove excess fat from meat. Remove fatty edges.
	Insert placed incorrectly on broil pan (some models).	Always place insert on the broil pan with ribs up and slot holes downward. This will allow grease to drip into pan.
	Excessive spillovers or grease built up inside oven.	Regular cleaning is needed when broiling frequently.
Flames inside oven or smoking from oven vent.	Excessive food spillovers in oven.	Wipe up any excessive spillovers before starting the oven. Should an oven fire occur, close the oven door and turn the oven OFF. If the fire continues, use a fire extinguisher. <b>DO NOT put water or flour on the fire!</b> Flour may be explosive.
Surface element does not heat.	Incorrect control setting.	Be sure the correct control is ON for the element that you are attempting to use.
Surface element slow to heat food.	Incorrect control setting.	Adjust the power level to a higher setting.
	Cookware much larger than element pattern on cooktop.	Move cookware to a larger element on cooktop if available or if possible place food in smaller cookware.
Surface element too hot or not hot enough.	Incorrect control setting.	Adjust the surface power level setting lower or higher to match the cookware size and quantity of food.
	Cookware material or weight.	Cookware materials and weight of the material affect heating. Heavy & medium-weight pans heat evenly. Because lightweight pans heat unevenly, foods may burn easily.
	Condition of cookware.	Use only flat, evenly balanced, medium or heavyweight cookware. Flat pans heat better than warped pans.
Surface element heating area extends beyond cookware bottom.	Cookware too small for cooktop element used.	If available, move cookware to smaller surface element or place food in larger cookware.

## BEFORE YOU CALL • Solutions to common problems

Problem	Possible Causes	Solutions
Scratches or abrasions on cooktop surface.	Coarse particles such as salt or sand between cookware and cooktop surface.	Be sure cooktop surface and bottom of cooking utensils are clean before usage. Small scratches on cooktop do not affect cooking and will become less visible with time.
	Cleaning materials not recommended for ceramic cooktop have been used.	See "Cooktop Cleaning" and "Cooktop Maintenance" in the <b>Care and Cleaning</b> section.
	Cookware with rough or dirty bottoms used.	Use clean, smooth, flat-bottomed cookware.
Metal marks on the cooktop.	Sliding or scraping of metal utensils on cooktop surface.	Do not slide metal utensils on cooktop surface. Use a ceramic-glass cooktop cleaning creme to remove the marks. See "Cooktop Cleaning" and "Cooktop Maintenance" in the <b>Care and Cleaning</b> section.
Brown streaks or specks on cooktop surface.	Boilovers are cooked onto cooktop surface.	Boilovers are cooked onto surface. Use razor blade scraper to remove soil. See "Cooktop Cleaning" and "Cooktop Maintenance" in the <b>Care &amp; Cleaning</b> section.
Areas of discoloration with metallic sheen on cooktop surface.	Mineral deposits from water and food.	Remove discoloration using a ceramic-glass cooktop cleaning creme. Always be sure to use cookware with clean, dry bottoms.



## MAJOR APPLIANCE WARRANTY

Your appliance is covered by a one year limited warranty. For one year from your original date of purchase, Electrolux will pay all costs for repairing or replacing any parts of this appliance that prove to be defective in materials or workmanship when such appliance is installed, used and maintained in accordance with the provided instructions.

### Exclusions

#### This warranty does not cover the following:

1. Products with original serial numbers that have been removed, altered or cannot be readily determined.
2. Product that has been transferred from its original owner to another party or removed outside the USA or Canada.
3. Rust on the interior or exterior of the unit.
4. Products purchased "as-is" are not covered by this warranty.
5. Food loss due to any refrigerator or freezer failures.
6. Products used in a commercial setting.
7. Service calls which do not involve malfunction or defects in materials or workmanship, or for appliances not in ordinary household use or used other than in accordance with the provided instructions.
8. Service calls to correct the installation of your appliance or to instruct you how to use your appliance.
9. Expenses for making the appliance accessible for servicing, such as removal of trim, cupboards, shelves, etc., which are not a part of the appliance when it is shipped from the factory.
10. Service calls to repair or replace appliance light bulbs, air filters, water filters, other consumables, or knobs, handles, or other cosmetic parts.
11. Surcharges including, but not limited to, any after hour, weekend, or holiday service calls, tolls, ferry trip charges, or mileage expense for service calls to remote areas, including the state of Alaska.
12. Damages to the finish of appliance or home incurred during installation, including but not limited to floors, cabinets, walls, etc.
13. Damages caused by: services performed by unauthorized service companies; use of parts other than genuine Electrolux parts or parts obtained from persons other than authorized service companies; or external causes such as abuse, misuse, inadequate power supply, accidents, fires, or acts of God.

#### DISCLAIMER OF IMPLIED WARRANTIES; LIMITATION OF REMEDIES

CUSTOMER'S SOLE AND EXCLUSIVE REMEDY UNDER THIS LIMITED WARRANTY SHALL BE PRODUCT REPAIR OR REPLACEMENT AS PROVIDED HEREIN. CLAIMS BASED ON IMPLIED WARRANTIES, INCLUDING WARRANTIES OF MERCHANTABILITY OR FITNESS FOR A PARTICULAR PURPOSE, ARE LIMITED TO ONE YEAR OR THE SHORTEST PERIOD ALLOWED BY LAW, BUT NOT LESS THAN ONE YEAR. ELECTROLUX SHALL NOT BE LIABLE FOR CONSEQUENTIAL OR INCIDENTAL DAMAGES SUCH AS PROPERTY DAMAGE AND INCIDENTAL EXPENSES RESULTING FROM ANY BREACH OF THIS WRITTEN LIMITED WARRANTY OR ANY IMPLIED WARRANTY. SOME STATES AND PROVINCES DO NOT ALLOW THE EXCLUSION OR LIMITATION OF INCIDENTAL OR CONSEQUENTIAL DAMAGES, OR LIMITATIONS ON THE DURATION OF IMPLIED WARRANTIES, SO THESE LIMITATIONS OR EXCLUSIONS MAY NOT APPLY TO YOU. THIS WRITTEN WARRANTY GIVES YOU SPECIFIC LEGAL RIGHTS. YOU MAY ALSO HAVE OTHER RIGHTS THAT VARY FROM STATE TO STATE.

### If You Need Service

Keep your receipt, delivery slip, or some other appropriate payment record to establish the warranty period should service be required. If service is performed, it is in your best interest to obtain and keep all receipts. Service under this warranty must be obtained by contacting Electrolux at the addresses or phone numbers below.

This warranty only applies in the USA and Canada. In the USA, your appliance is warranted by Electrolux Major Appliances North America, a division of Electrolux Home Products, Inc. In Canada, your appliance is warranted by Electrolux Canada Corp. Electrolux authorizes no person to change or add to any obligations under this warranty. Obligations for service and parts under this warranty must be performed by Electrolux or an authorized service company. Product features or specifications as described or illustrated are subject to change without notice.

**USA**  
**1.800.944.9044**  
Electrolux Home Products, Inc.  
10200 David Taylor Drive  
Charlotte, NC 28262



**Canada**  
**1.800.265.8352**  
Electrolux Canada Corp.  
5855 Terry Fox Way  
Mississauga, Ontario, Canada  
L5V 3E4