

SHARP®

LL-S201A

LCD MONITOR

OPERATION MANUAL

HDMI™
HIGH-DEFINITION MULTIMEDIA INTERFACE

 **MHL**™
Mobile High-Definition Link

IMPORTANT:

To aid reporting in case of loss or theft, please record the product's model and serial numbers in the space provided. The numbers are located in the rear of the product.

Model No.:

Serial No.:

U.S.A. ONLY

This device complies with Part 15 of the FCC Rules. Operation is subject to the following two conditions: (1) This device may not cause harmful interference, and (2) this device must accept any interference received, including interference that may cause undesired operation.

WARNING:

FCC Regulations state that any unauthorized changes or modifications to this equipment not expressly approved by the manufacturer could void the user's authority to operate this equipment.

NOTE:

This equipment has been tested and found to comply with the limits for a Class B digital device pursuant to Part 15 of the FCC Rules. These limits are designed to provide reasonable protection against harmful interference in a residential installation.

This equipment generates, uses and can radiate radio frequency energy and, if not installed and used in accordance with the instructions, may cause harmful interference to radio communications. However, there is no guarantee that interference will not occur in a particular installation. If this equipment does cause harmful interference to radio or television reception, which can be determined by turning the equipment off and on, the user is encouraged to try to correct the interference by one or more of the following measures:

- Reorient or relocate the receiving antenna.
- Increase the distance between the equipment and receiver.
- Connect the equipment into an outlet on a circuit different from that to which the receiver is connected.
- Consult the dealer or an experienced radio/TV technician for help.

Use nothing but the included cables and AC cord to insure compliance with FCC regulation for Class B computing equipment.



U.S.A. ONLY

This Class B digital apparatus complies with Canadian ICES-003.

CANADA ONLY

IMPORTANT INFORMATION

WARNING: TO REDUCE THE RISK OF FIRE OR ELECTRIC SHOCK, DO NOT EXPOSE THIS PRODUCT TO RAIN OR MOISTURE.

	CAUTION RISK OF ELECTRIC SHOCK DO NOT OPEN	
<p>CAUTION: TO REDUCE THE RISK OF ELECTRIC SHOCK, DO NOT REMOVE COVER. NO USER-SERVICEABLE PARTS INSIDE. REFER SERVICING TO QUALIFIED SERVICE PERSONNEL.</p>		



The lightning flash with arrowhead symbol, within a triangle, is intended to alert the user to the presence of uninsulated “dangerous voltage” within the product’s enclosure that may be of sufficient magnitude to constitute a risk of electric shock to persons.



The exclamation point within a triangle is intended to alert the user to the presence of important operating and maintenance (servicing) instructions in the literature accompanying the product.

DEAR SHARP CUSTOMER

Thank you for your purchase of a SHARP LCD product. To ensure safety and many years of trouble-free operation of your product, please read the Safety Precautions carefully before using this product.

SAFETY PRECAUTIONS

Electricity is used to perform many useful functions, but it can also cause personal injuries and property damage if improperly handled. This product has been engineered and manufactured with the highest priority on safety. However, improper use can result in electric shock and/or fire. In order to prevent potential danger, please observe the following instructions when installing, operating and cleaning the product. To ensure your safety and prolong the service life of your LCD product, please read the following precautions carefully before using the product.

1. Read instructions — All operating instructions must be read and understood before the product is operated.
2. Keep this manual in a safe place — These safety and operating instructions must be kept in a safe place for future reference.
3. Observe warnings — All warnings on the product and in the instructions must be observed closely.
4. Follow instructions — All operating instructions must be followed.
5. Cleaning — Unplug the power cord from the AC outlet before cleaning the product. Use a dry cloth to clean the product. Do not use liquid cleaners or aerosol cleaners.
6. Attachments — Do not use attachments not recommended by the manufacturer. Use of inadequate attachments can result in accidents.
7. Water and moisture — Do not use the product near water. Do not install the product in a place where water may splash onto it. Be careful of equipment which drains water such as an air-conditioner.
8. Ventilation — The vents and other openings in the cabinet are designed for ventilation. Do not cover or block these vents and openings since insufficient ventilation can cause overheating and/or shorten the life of the product. Do not place the product on a sofa, rug or other similar surface, since they can block ventilation openings. Do not place the product in an enclosed place such as a bookcase or rack, unless proper ventilation is provided or the manufacturer's instructions are followed.
9. Power cord protection — The power cords must be routed properly to prevent people from stepping on them or objects from resting on them.
10. The screen used in this product is made of glass. Therefore, it can break when the product is dropped or applied with impact. Be careful not to be injured by broken glass pieces in case the screen breaks.
11. Overloading — Do not overload AC outlets or extension cords. Overloading can cause fire or electric shock.
12. Entering of objects and liquids — Never insert an object into the product through vents or openings. High voltage flows in the product, and inserting an object can cause electric shock and/or short internal parts. For the same reason, do not spill water or liquid on the product.
13. Servicing — Do not attempt to service the product yourself. Removing covers can expose you to high voltage and other dangerous conditions. Request a qualified service person to perform servicing.
14. Repair — If any of the following conditions occurs, unplug the power cord from the AC outlet, and request a qualified service person to perform repairs.
 - a. When the power cord or plug is damaged.
 - b. When a liquid was spilled on the product or when objects have fallen into the product.
 - c. When the product has been exposed to rain or water.
 - d. When the product does not operate properly as described in the operating instructions. Do not touch the controls other than those described in the operating instructions. Improper adjustment of controls not described in the instructions can cause damage, which often requires extensive adjustment work by a qualified technician.
 - e. When the product has been dropped or damaged.
 - f. When the product displays an abnormal condition. Any noticeable abnormality in the product indicates that the product needs servicing.
15. Replacement parts — In case the product needs replacement parts, make sure that the service person uses replacement parts specified by the manufacturer, or those with the same characteristics and performance as the original parts. Use of unauthorized parts can result in fire, electric shock and/or other danger.
16. Safety checks — Upon completion of service or repair work, request the service technician to perform safety checks to ensure that the product is in proper operating condition.
17. Wall mounting — When mounting the product on a wall, be sure to install the product according to the method recommended by the manufacturer.
18. Heat sources — Keep the product away from heat sources such as radiators, heaters, stoves and other heat-generating products (including amplifiers).

SAFETY PRECAUTIONS (Continued)

19. Usage of the monitor must not be accompanied by fatal risks or dangers that, could lead directly to death, personal injury, severe physical damage or other loss, including nuclear reaction control in nuclear facility, medical life support system, and missile launch control in a weapon system.
20. Do not touch the parts of the product or the AC adapter that become hot for long periods of time. Doing so may result in low-temperature burns.

To maintain compliance with EMC regulations, use shielded cables to connect to the following terminals: HDMI input terminal and DisplayPort input terminal.

If a monitor is not positioned in a sufficiently stable location, it can be potentially hazardous due to falling. Many injuries, particularly to children, can be avoided by taking simple precautions such as:

- Using fixing devices like wall mount brackets recommended by the manufacturer.
- Only using furniture that can safely support the monitor.
- Ensuring the monitor is not overhanging the edge of the supporting furniture.
- Not placing the monitor on tall furniture (for example, cupboards or bookcases) without anchoring both the furniture and the monitor to a suitable support.
- Not standing the monitors on cloth or other materials placed between the monitor and supporting furniture.
- Educating children about the dangers of climbing on furniture to reach the monitor or its controls.

TIPS AND SAFETY INSTRUCTIONS

- The TFT color LCD panel used in this monitor is made with the application of high precision technology. However, there may be minute points on the screen where pixels never light or are permanently lit. Also, if the screen is viewed from an acute angle there may be uneven colors or brightness. Please note that these are not malfunctions but common phenomena of LCDs and will not affect the performance of the monitor.
- Do not display a still picture for a long period, as this could cause a residual image.
- Never rub or tap the monitor with hard objects.
- Please understand that SHARP CORPORATION bears no responsibility for errors made during use by the customer or a third party, nor for any other malfunctions or damage to this product arising during use, except where indemnity liability is recognized under law.
- This monitor and its accessories may be upgraded without advance notice.
- Do not use the monitor where there is poor ventilation, where there is a lot of dust, where humidity is high, or where the monitor may come into contact with oil or steam.
- Ensure that the monitor does not come into contact with water or other fluids. Ensure that no objects such as paper clips or pins enter the monitor as this could lead to fire or electric shock.
- Do not place the monitor on top of unstable objects or in unsafe places. Do not allow the monitor to receive strong shocks or to strongly vibrate. Causing the monitor to fall or topple over may damage it.
- Continuous Operation Time and Warranty
This product has been designed based on the assumption of 15 or fewer hours of usage in one day. Continuous usage that exceeds 15 hours in one day is not covered by the warranty.
- Do not use the monitor near heating equipment or in places where there is likelihood of high temperature, as this may lead to generation of excessive heat and outbreak of fire.
- Do not use the monitor in places where it may be exposed to direct sunlight.
- The AC outlet shall be installed near the equipment and shall be easily accessible.
- Do not touch the screen when starting the LCD monitor. If the screen is touched, the monitor may not function correctly. In this situation, turn the LCD monitor off, wait at least 5 seconds, and then turn on the monitor again.
- Do not operate the screen with a hard or pointed object such as a fingernail, pen other than the included touch pen, or a sharp pencil.
- Depending on the application used, the supplied touch pen may not function.
- If another USB device is connected to the computer to which the touch panel is connected, do not operate the USB device during touch panel input. Input may not take place correctly.
- Do not use liquid such as alcohol in cleaning the screen.
- Keep all cables off the touch panel. Not doing so may lead to LCD monitor malfunctions.
- If used in a room (or location) with drastic temperature differences, the display quality of the screen and the quality of touch panel performance may decrease.

The Power Cord and AC adapter

- Use only the power cord and AC adapter supplied with the monitor.
- When handling the AC adapter, observe the following: Incorrect handling may result in fire, electric shock, or injury.
 - Do not drop the AC adapter or subject it to impact.
 - Never disassemble the AC adapter. It contains high voltage parts that are dangerous to touch.
 - The AC adapter is for indoor use only. Do not use it outside.
 - Do not use the supplied AC adapter with other devices.
- Do not damage the power cord and AC adapter nor place heavy objects on it, stretch it or over bend it. Also, do not add extension cords. Damage to the cord may result in fire or electric shock.
- Do not use the power cord with a power tap. Adding an extension cord may lead to fire as a result of overheating.
- Do not remove or insert the power plug with wet hands. Doing so could result in electric shock.
- Unplug the power cord if it is not used for a long time.
- Do not attempt to repair the power cord if it is broken or malfunctioning. Refer the servicing to the service representative.
- Do not stay in contact with the parts of the product and the AC adapter that become hot for long periods of time. Doing so may result in low-temperature burns.
- For your health, observe the following:
 - If using the monitor continuously, take a 10- to 15-minute break every hour to rest your eyes.
 - Do not use the monitor in high-contrast light conditions.
 - Do not use the monitor in locations where the screen is subject to direct sunlight.

Manual Scope

- Microsoft, Windows and Windows Vista are registered trademarks of Microsoft Corporation.
- The terms HDMI and HDMI High-Definition Multimedia Interface, and the HDMI Logo are trademarks or registered trademarks of HDMI Licensing LLC in the United States and other countries.
- DisplayPort is a registered trademark of Video Electronics Standards Association.
- Adobe, Acrobat, and Reader are either registered trademarks or trademarks of Adobe Systems Incorporated in the United States and/or other countries.
- Intel, Celeron, and Intel Core 2 Duo are trademarks or registered trademarks of Intel Corporation or its subsidiaries in the U.S.A. and other countries.
- AMD, AMD Sempron, AMD Athlon, and combinations thereof are trademarks of Advanced Micro Devices, Inc.
- MHL, the MHL logo, and Mobile High-Definition Link are trademarks or registered trademarks of MHL, LLC in the United States and other countries.
- All other brand and product names are trademarks or registered trademarks of their respective holders.
- Language of OSD menu used in this manual is English by way of example.
- Illustrations in this manual may not exactly represent the actual product or display.

LED Backlight

- The LED backlight in this product has a limited lifetime.
 - * If the screen gets dark or does not turn on, it may be necessary to replace the LED backlight. This LED backlight is exclusive to this product and must be replaced by an authorized SHARP servicing dealer or service center.
 - * Please contact your local SHARP servicing dealer or service center for assistance.

Contents

IMPORTANT INFORMATION	3	Turning Power On/Off	13
DEAR SHARP CUSTOMER	4	Turning on the power	13
SAFETY PRECAUTIONS	4	Turning off the power	13
TIPS AND SAFETY INSTRUCTIONS	6	Touch Action	14
Supplied Components	7	Touch action modes	14
System Requirements	7	Touch action	14
Part Names	8	Other functions	16
Binding Cables	9	Cautionary points	16
Connecting Peripheral Equipment	9	Monitor Settings	17
Connection with a PC.....	9	Menu operations	17
Connecting headphones (commercially available).....	10	Menu functions	18
Connecting the monitor to a power source	10	SETUP Menu Details	19
Installation	11	Prohibiting operations (operation lock).....	20
Standing position.....	11	Monitor status indicators	21
Pen writing position	12	Troubleshooting	22
Horizontal position.....	12	Specifications	23

For information on the Pen Software, see the Pen Software Operation Manual.

Supplied Components

If any component should be missing, please contact your dealer.

- | | |
|--|---|
| <input type="checkbox"/> Liquid Crystal Display Monitor: 1 | <input type="checkbox"/> AC adapter: 1 |
| <input type="checkbox"/> Power cord: 1 | <input type="checkbox"/> USB cable (USB-microUSB Type B): 1 |
| <input type="checkbox"/> CD-ROM (Utility Disk): 1 | <input type="checkbox"/> Stand (front, back, bottom cover, fixing screws: 2): 1 |
| <input type="checkbox"/> Setup Manual: 1 | |
| <input type="checkbox"/> Touch pen: 1 | |

- * SHARP Corporation holds authorship rights to the Utility Disk program. Do not reproduce it without permission.
- * Keep packaging for use when transporting monitor, etc.

System Requirements

■Touch Panel

To use the touch panel, the monitor must be connected to a computer using a USB cable.

Touch panel operating conditions are as described below.

Computer	PC/AT compatible computer with a USB 1.1 port and able to output a resolution of 1920 x 1080.
OS	Windows 8 (32-bit or 64-bit version), Windows 7 (32-bit or 64-bit version), Windows Vista (32-bit or 64-bit version), Windows XP (32-bit or 64-bit version)

- Windows 7 or later is recommended for touch action.
- On Windows 7 and later, the touch panel operates with the standard Window driver. On Windows Vista/XP, you must install the touch panel driver to your PC from the included CD-ROM.

■Pen Software

Operating conditions for the included Pen Software are as described below. To install Pen Software, refer to the Pen Software Operation Manual. Pen Software is for use with monitors installed in landscape orientation.

Computer	PC/AT compatible computer able to output a resolution of 1920 x 1080. (CD-ROM drive required for software installation.)
OS	Windows 8 (32-bit or 64-bit version), Windows 7 (32-bit or 64-bit version), Windows Vista (32-bit or 64-bit version), Windows XP (32-bit or 64-bit version)
CPU	Intel Celeron or AMD Sempron 1.6 GHz or faster Intel Core 2 Duo or AMD Athlon II X2 2.8 GHz or faster recommended
Memory	At least 2 GB (at least 1 GB for Windows XP)
Free space on hard drive	At least 100 MB (free space separately required for data storage)

Part Names

■ Front view

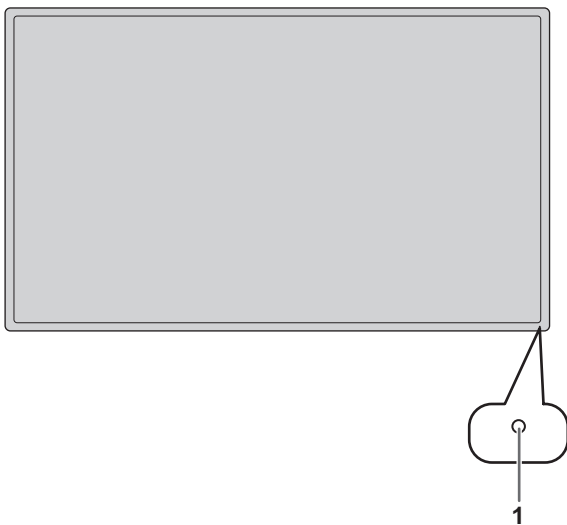

1. **Power LED** (See page 13.)

■ Rear view

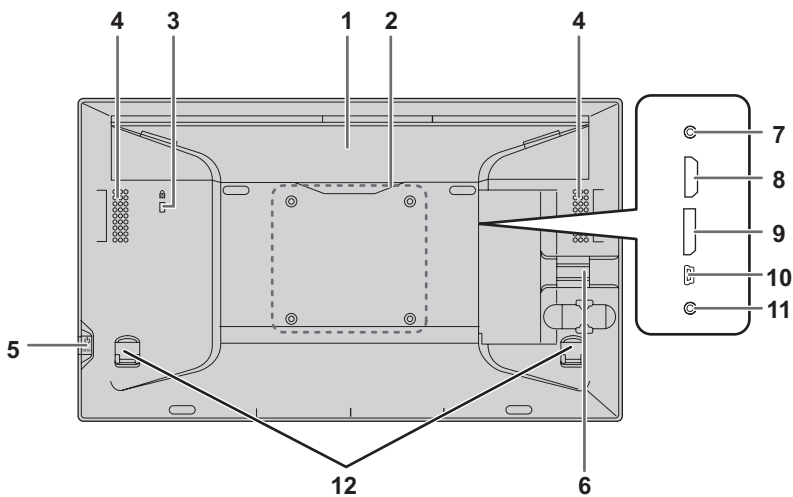

1. **Flap** (See page 12.)
2. **VESA holes** (See page 24.)
3. **Anti-theft hole** (🔒)
Allows the monitor to be secured using a commercially available anti-theft lock. The anti-theft hole is compatible with Kensington's MicroSaver security system.
4. **Speakers**
5. **Power/Menu button** (See page 13, page 17.)
6. **Cable clamp** (See page 9.)
7. **Headphone jack** (See page 10.)
8. **HDMI input terminal** (See page 9.)
9. **DisplayPort input terminal** (See page 9.)
10. **Micro-USB terminal** (See page 10.)
11. **AC adapter connection terminal** (See page 10.)
12. **Tabs** (See page 12.)

Binding Cables

Secure the HDMI cable, DisplayPort cable, and USB cable using the cable clamp.

1. Remove the cable clamp.

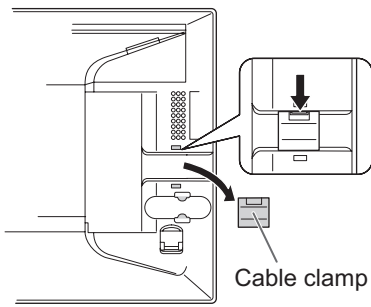

2. Route the cables through the cable restraint slot.

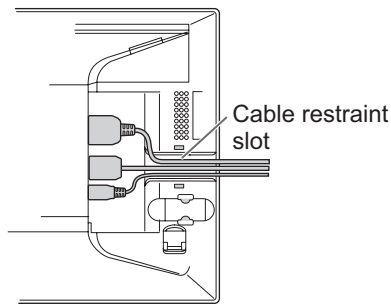

3. Push the cable clamp down into place.

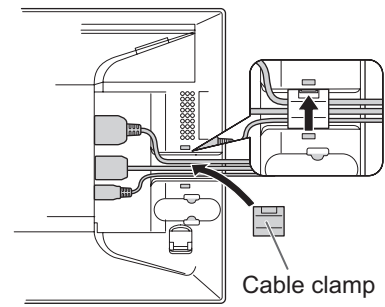

! Caution

- When connecting cables, spread a soft cloth on a stable level surface such as a desk, and gently place the monitor on it with the screen facing down.

Connecting Peripheral Equipment

! Caution

- Be sure to turn off the power and disconnect the plug from the power outlet before connecting/disconnecting cables. Also, read the manual of the equipment to be connected.
- Do not forcibly bend or apply force to cables. Doing so may result in wire breakage or other damage.
- When connecting cables, spread a soft cloth on a stable level surface such as a desk, and gently place the monitor on it with the screen facing down.
- Do not use any cable that has a damaged or deformed terminal. Using such cables may cause malfunctions.

TIPS

- Images may not be displayed properly depending on the computer (video card) to be connected.

Connection with a PC

Connect the monitor and a PC using the connection cable.

■ Inputting video and audio

HDMI input terminal

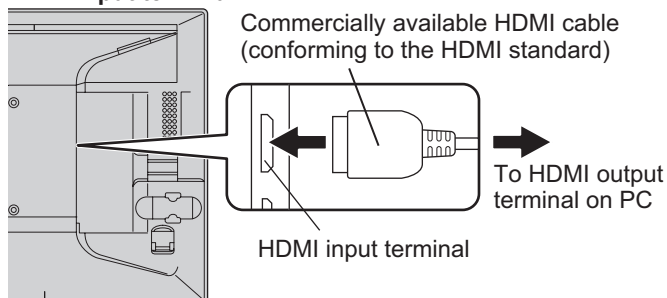

Check the orientation of the connector and insert it horizontally as far as it will go.

- It is possible to connect the monitor's HDMI input terminal to a smartphone or similar MHL-compliant device using a commercially available MHL cable. This production incorporates MHL 1.

DisplayPort input terminal

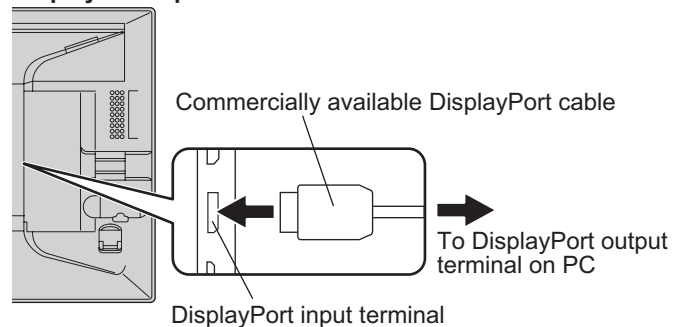

Check the orientation of the connector and insert it horizontally as far as it will go.

TIPS

- The length of the signal cables or surrounding environment may affect the image quality.
- The video from the terminal that has signal input is displayed. In this state, even if a signal is input from the other terminal, the display is not switched. To switch the display, use [Input Select] on the menu screen. (See page 18.)
- If the LCD monitor is turned on when there are input signals from both terminals, the video from the DisplayPort input terminal is displayed.

Connecting Peripheral Equipment

■ Using the touch panel

To use the touch panel, connect the monitor to a USB port on a PC using the supplied USB cable.

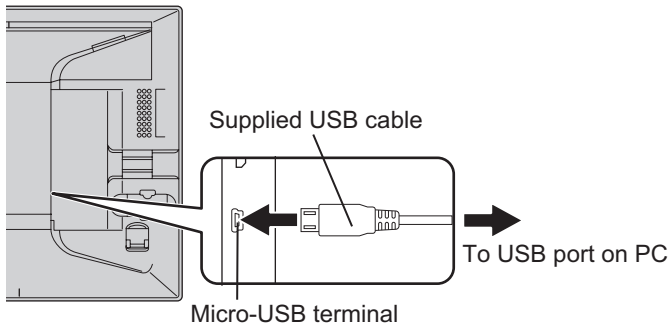

Check the orientation of the connector and insert it horizontally as far as it will go.

Connecting headphones (commercially available)

Headphones (commercially available) with a stereo mini plug (ϕ 3.5 mm) can be connected to the monitor.

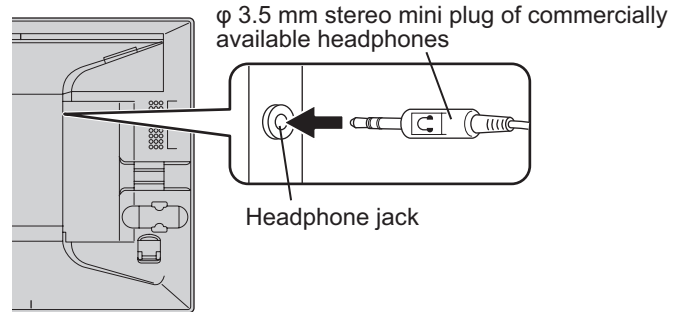

TIPS

- When headphones are connected it will no longer be possible to hear sound from the monitor's speakers.
- Volume can be adjusted using [Volume] on the menu screen. (See page 18.)
- The volume is set to 0 when the monitor is shipped from the factory.

Connecting the monitor to a power source

! Caution

- Use only the AC adapter and power cord supplied with the monitor.

1. Connect the monitor to the power outlet using the supplied AC adapter and power cord.

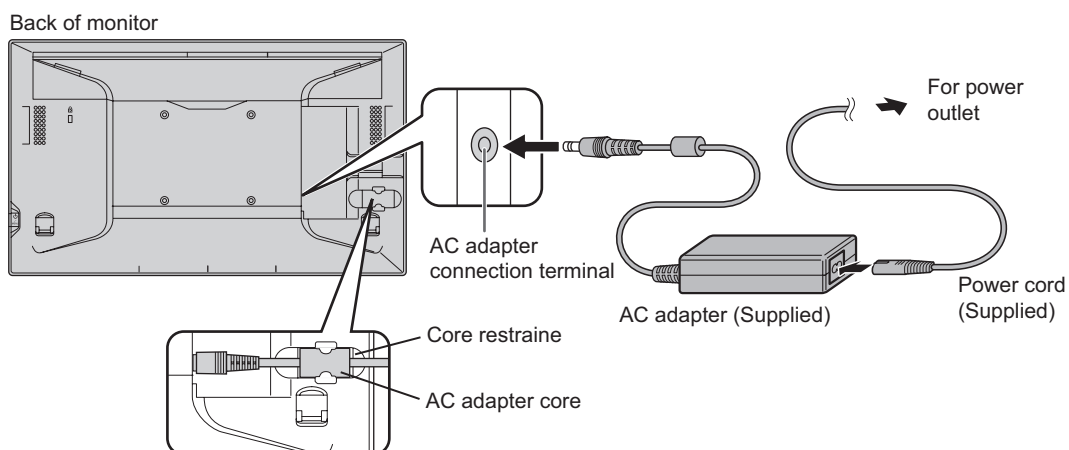

2. Push the AC adapter core into the core restrainer.

Installation

The monitor can be installed in three different ways.

Standing position

Place the monitor on the supplied stand.

! Caution

- The stand is for use in landscape orientation. It cannot be used for portrait orientation.

■ Assembling the stand

1. Insert the back into the front.

Align the mark (Δ) on the front with the edge of the back and insert the back from above.

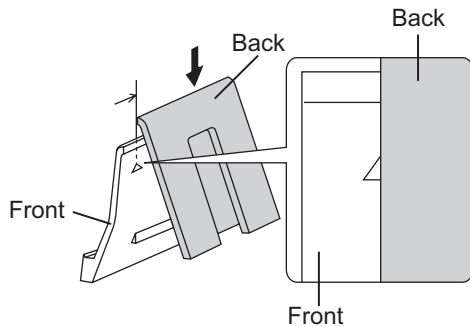

2. Slide the back across.

Slide the back until it clicks into place.

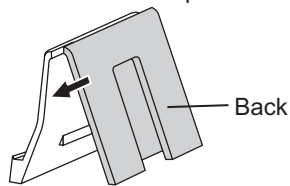

3. Attach the bottom cover.

Align the arrow on the bottom cover so that it points toward the front, and press the projections on the bottom cover into the pocket on the front and back.

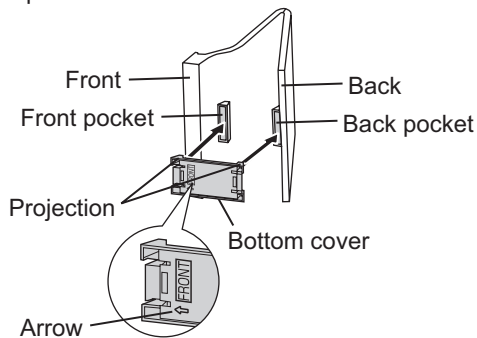

■ Mounting the monitor on the stand

1. Place the stand on a level surface.

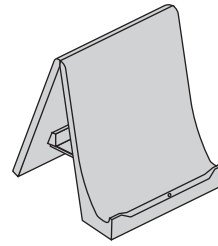

2. Set the monitor on the stand.

Set the monitor so that the logo in the center is aligned with the circle mark on the stand.

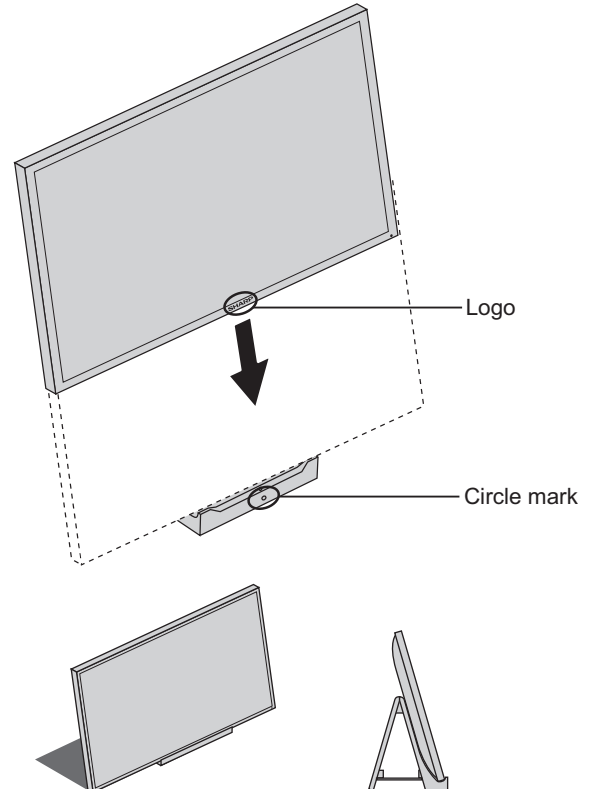

TIPS

- The stand and the monitor can be secured with fixing screws.

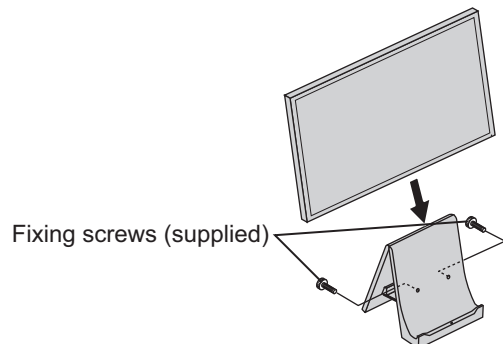

Installation

■ Disassembling the stand

1. Remove the bottom cover.

Push the tabs in towards the center and pull.

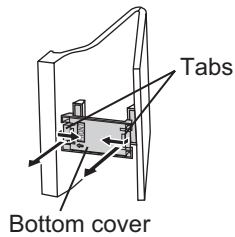

2. Remove the back from the front.

Depress the button on the front and slide the back across, then pull the back up.

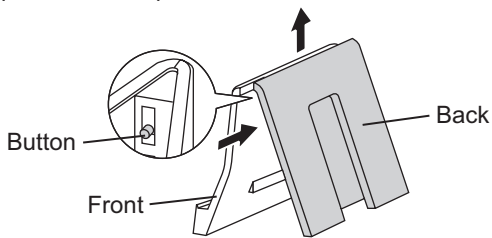

Pen writing position

Place the monitor at an angle on a table or other level surface.

1. Hold the flap by the depression on the back of the monitor and pull the flap up.

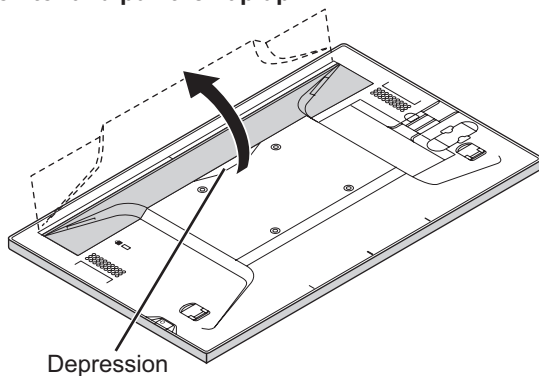

2. Place the monitor where you want to use it.

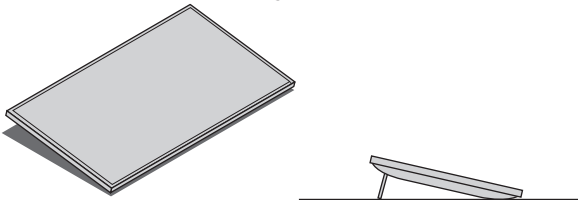

! Caution

- Do not exert a large amount of force on the monitor from above. Doing so may damage the flap.

Horizontal position

Place the monitor on a table or other level surface.

! Caution

- When using the monitor horizontally, use the horizontal tab in the upright position.

1. Lift up the two tabs on the back of the monitor.

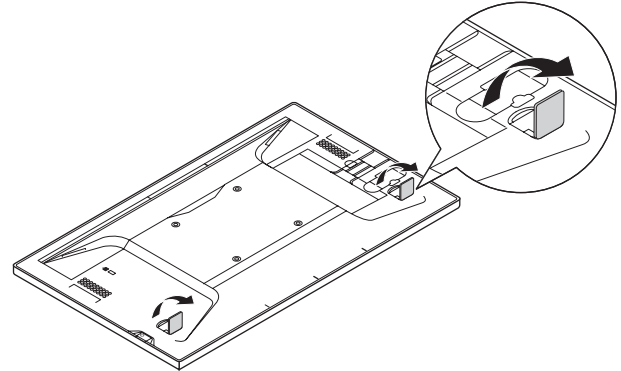

2. Place the monitor where you want to use it.

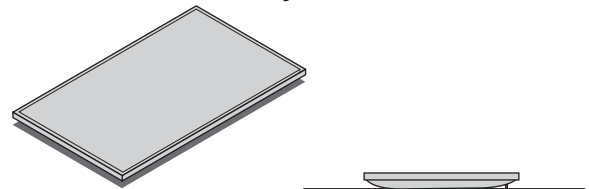

! Caution

- Do not exert a large amount of force on the monitor from above. Doing so may damage the tabs.

Turning Power On/Off

Turning on the power

1. Press the POWER button.

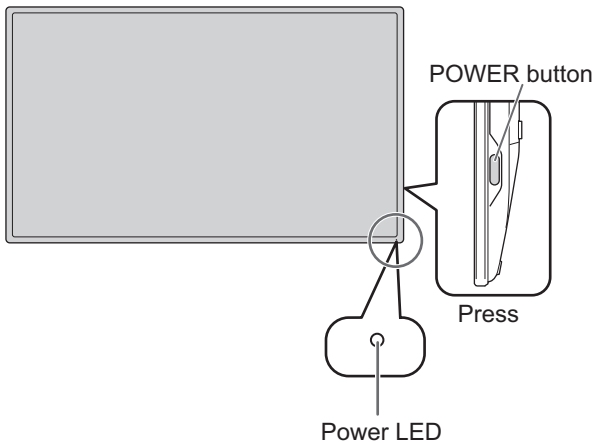

The power LED turns on.

2. Turn on the PC.

The screen appears.

Status	Status of the monitor
Green lit	Signal input
Orange lit	No signal input

! Caution

- When switching the POWER button off and back on, always wait for an interval of at least 5 seconds. Rapid switching may lead to errors or malfunctions.
- For a complete electrical disconnection, pull out the main plug.

Turning off the power

1. Turn off the PC.
2. Depress the POWER button for around 2 seconds.

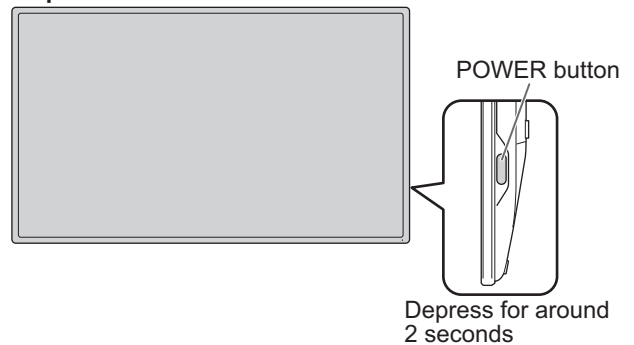

The power LED turns off.

! Caution

- If the monitor will not be used for a long time, disconnect the power plug from the power outlet.

Touch Action

Touch action modes

There are three touch action modes: finger/pen mode, pen-only mode, and finger-only mode. These modes can be changed on the menu screen.

The monitor is set to finger/pen mode when shipped.

Finger/pen mode

In this mode, the screen can be touched with your finger or with the touch pen.

While the screen is being touched with the touch pen, touch pen operation is given priority and you cannot touch the screen with your finger.

Once the touch pen has been moved away from the screen for around 1 second, you can touch the screen with your finger.

Pen-only mode

This mode is for touch pen use only. You cannot touch the screen with your finger. You can touch the menu screen (See page 17) with your finger.

Finger-only mode

This mode is for finger use only. You cannot touch the screen with the touch pen.

Touch action

Touch actions that can be used with this monitor differ according to operating system and application. The functions of touch actions are also different. For details, check Windows Help and the application's support documentation.

Touch action	OS		
	Windows 8	Windows 7	Windows Vista Windows XP *
Single-tap	Yes	Yes	Yes
Double-tap	Yes	Yes	Yes
Swipe	Yes	Yes	Yes
Swipe from edge of screen	Yes	No	No
Drag-and-drop	Yes	Yes	Yes
Slide to pan	Yes	Yes	No
Flicks	Yes	Yes	No
Press-and-hold	Yes	Yes	No
Zoom	Yes	Yes	No
Press-and-tap	No	Yes	No
Rotate	Yes	Yes	No

* You must install the touch panel driver to your PC from the included CD-ROM.

TIPS

- In Windows 7, if the checkmark has been removed from "Enable multi-touch gestures and inking" in "Pen and touch" in Control Panel, select the checkbox.

Common finger and touch pen actions

Single-tap

Touch the screen with your finger/touch pen.

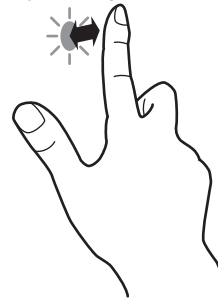

Double-tap

Quickly touch the screen twice with your finger/touch pen.

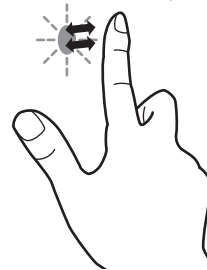

Swipe

Touch the screen with your finger/touch pen, move without lifting, and then stop.

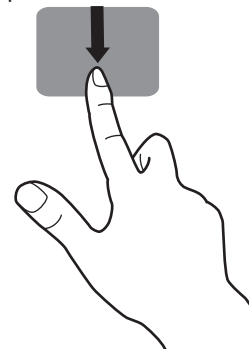

Swipe from edge of screen

After touching the edge of the monitor with your finger/touch pen, move horizontally without releasing your finger/touch pen and then stop.



Drag-and-drop

Touch the screen with your finger/pen and move without lifting. When you have finished the movement, lift your finger/touch pen.

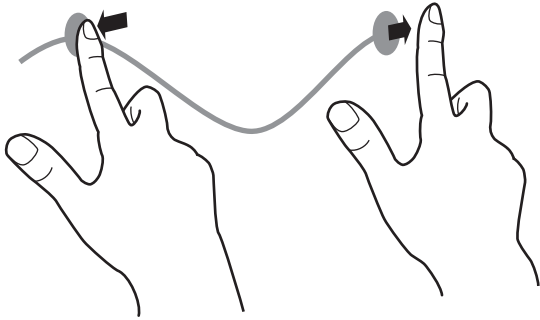

Slide to pan

With your finger/touch pen touching the screen, move it up and down to scroll the screen.

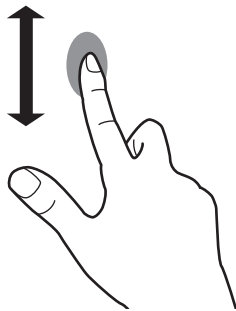

Flicks

Move your finger/touch pen in a flicking motion.

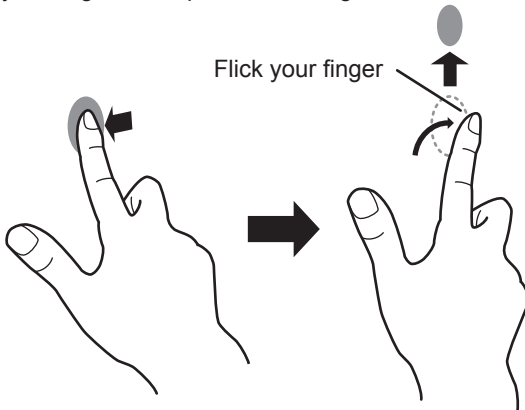

Press-and-hold

Press briefly with your finger/touch pen, and then lift your finger/touch pen from the screen.

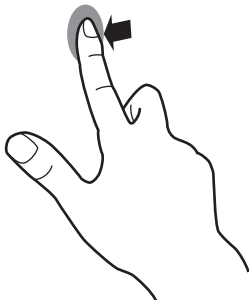

■Finger actions

Zoom

While touching the screen with two fingers, move them closer together and farther apart.

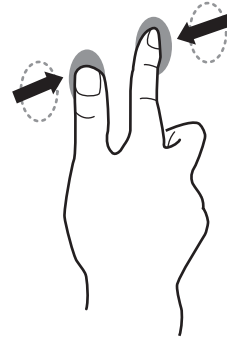

Pinch

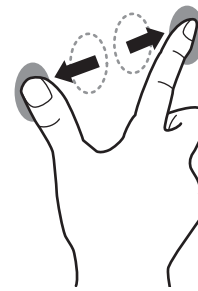

Stretch

Press-and-tap

With one finger touching the screen, tap once (single tap) with another finger.

Tap once (single tap) with another finger

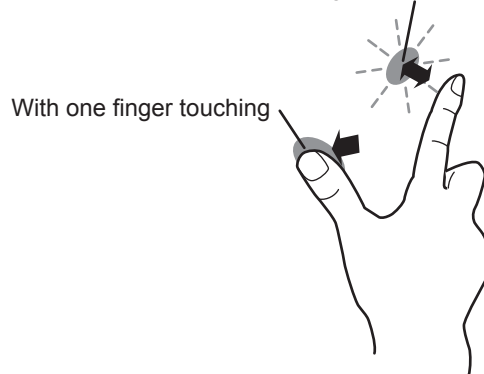

Rotate

While touching the monitor with one finger, move the other finger in the direction you wish to rotate in.

Move another finger in the desired direction of rotation

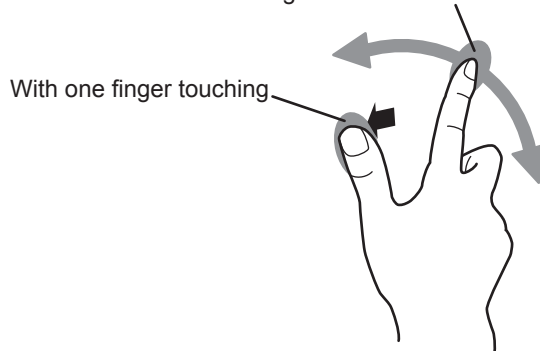

Other functions

In Windows 8, input panel functions can be used.

In Windows 7, touch pointer and input panel functions can be used.

For information about the touch pointer and input panel functions, see Windows Help.

Touch pointer :

A translucent image of a mouse appears near the point touched. The left/right buttons of the image can be clicked to perform the same actions as left/right clicking a mouse.

Input panel :

A software keyboard and an input panel with handwriting recognition appear on the screen.

Windows 8 and Windows 7 (excluding Starter), the ink function of Microsoft Office can be used.

Handwritten comments can be written, and handwriting can be recognized.

For details, see Microsoft Office Help.

Cautionary points

- When performing touch actions, use the ball of your finger.
- When performing pen actions, use the included touch pen.
- Do not use the touch pen for any purpose other than touch panel operation.
- Do not press hard on the tip of the touch pen.
- If there is dirt or foreign matter on the tip of the touch pen, remove it. Failure to do so may damage the screen.
- Even when in pen-only mode, the monitor may respond to objects other than the included touch pen.
- When performing pen actions with the included touch pen, do not touch the screen with anything other than the hand that is holding the pen.

Monitor Settings

Menu operations

The monitor settings are configured by displaying the menu screen.

The operations on this page are the basic operations.

! Caution

- Do not turn off the power while the menu screen is displayed. Doing so may initialize the settings.
- While the menu screen is displayed, touch actions are not possible other than those for the menu screen.

■ Example of operation

Operations on the menu screen are described here using adjusting the volume as an example.

1. Press the MENU button.

The menu screen appears.

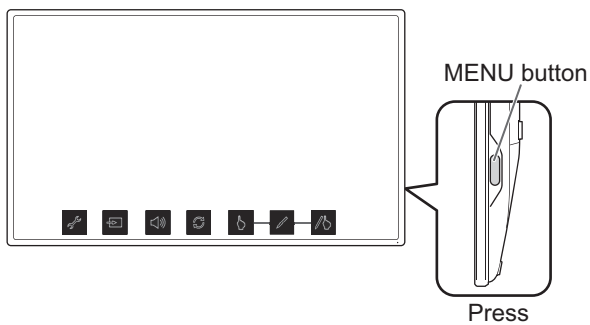

2. Touch [Volume].

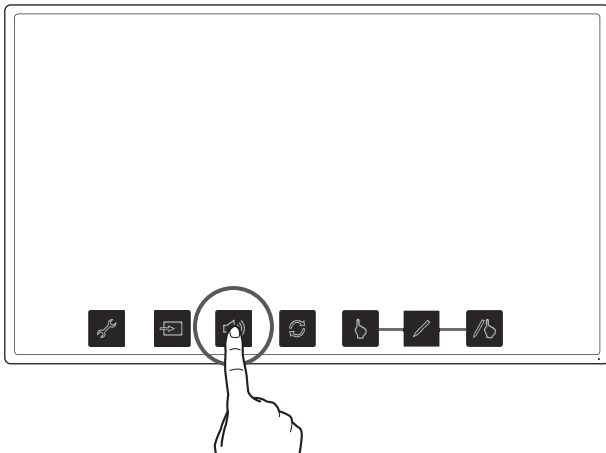

3. Touch the adjustment bar and slide your finger to either side to adjust the volume.

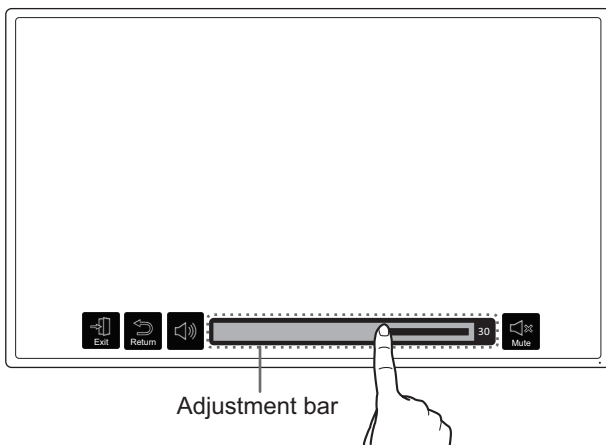

4. Touch [Exit] or press the MENU button.

The menu screen disappears.

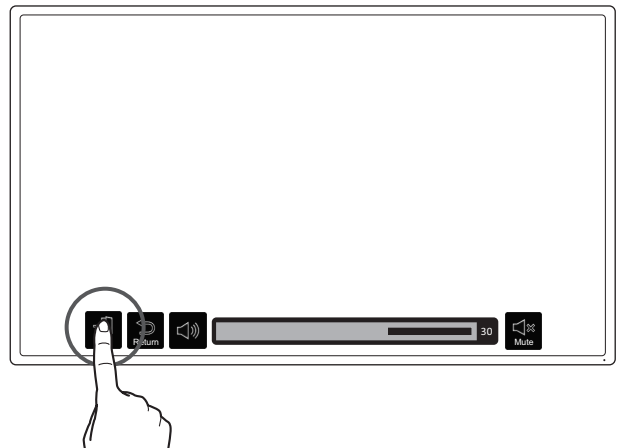

Touch [Return] to return to the level above.

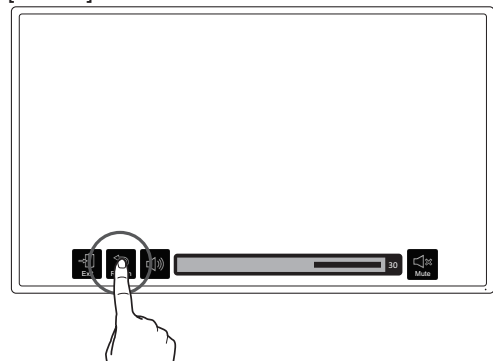

TIPS

- If no actions are made on the adjustment bar display screen for around 10 seconds, the screen returns to the ordinary display screen.
- The menu screen can also be operated using your finger in pen-only mode.

Menu functions

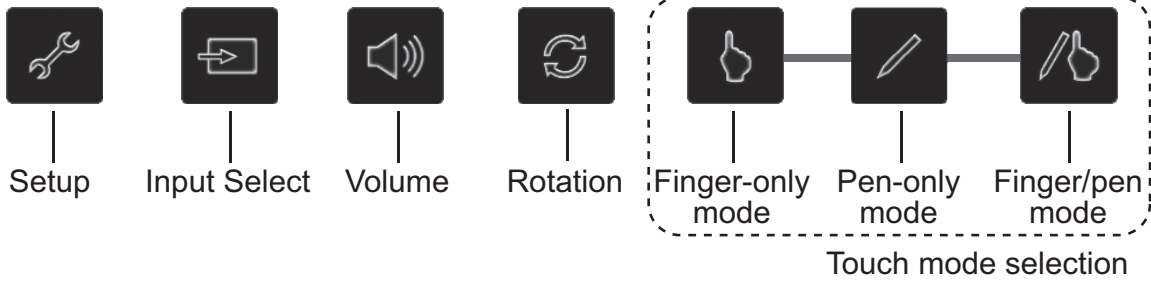

Touch mode selection

These icons switch the touch action mode.

A (▣) mark is displayed at the top of the icon for the selected mode.

The mode can be checked with the touch mark located at the upper-right portion of the screen. (See pages 19, 21)



Finger/pen mode

This icon switches the touch action mode to finger/pen mode.

The touch mark becomes the finger/pen mark (▣).



Pen-only mode

This icon switches the touch action mode to pen-only mode.

The touch mark becomes the pen mark (▣).



Finger-only mode

This icon switches the touch action mode to finger-only mode.

The touch mark becomes the finger-only mark (▣).



Rotation

This icon lets you rotate the screen 180°.

When the monitor is rotated, a (▣) mark is displayed at the top of the icon.

The rotate mark (▣) also appears on the screen. (See pages 19, 21)



Volume

This icon adjusts speaker and headphone volume.

Touching [Mute] temporarily sets the volume to 0.

Touching [Mute] again returns the volume to the previous level.



Input Select

This icon manually switches the signal input source from the PC.

Touching the icon displays HDMI and DisplayPort.

A (▣) mark is added to the input source being displayed.



Setup

This icon configures the monitor.

For details on individual settings, see page 19.

SETUP Menu Details



Position

When the monitor is used in portrait orientation (power/menu button on the top), this icon moves the display position of the menu screen to the bottom of the screen.

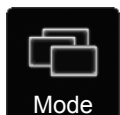

Mode

Normal

This mode is suited to normal PC screen display.

Pen Writing

This mode is suited to pen writing position.

Game

This mode is suited to video games.

Multimedia

This mode is suited to video playback.

User

The user can adjust the image quality.



Brightness

This icon adjusts the brightness of the backlight.



Other

Mode on Start Up

Touch Mode

This setting configures the touch action mode (See page 18) used when the monitor is turned on.

[Reset] : The monitor starts in finger/pen mode.

[Save] : The monitor starts in the mode that was last used.

Rotate Mode

This setting configures the rotate setting (See page 18) used when the monitor is turned on.

[Reset] : The monitor starts with rotate disabled.

[Save] : The monitor starts in the mode that was last used.

Position

This setting configures the menu display position used when the monitor is turned on.

[Reset] : The monitor starts with the menu display position on the bottom of landscape orientation.

[Save] : The monitor starts in the mode that was last used.

Mark

Touch Mark

This setting configures how to display the touch mark (See page 21).

Rotation Mark

This setting configures how to display the rotation mark (See page 21).

Key Mark

This setting configures how to display the key mark (See page 20).

Mark Position

This setting configures the display position of the status display mark (touch mark/rotation mark/key mark) on the screen.

Logo Screen

This setting configures whether or not to display the logo screen during startup.

[On]: The logo screen is displayed when the monitor starts.

[Off]: The logo screen is not displayed when the monitor starts.



Language

This setting changes the menu screen display language.



Reset

This setting resets all settings to their factory default.

Prohibiting operations (operation lock)

This function makes it possible to prohibit operations to turn the power off and to prohibit touch action on the screen. If an operation is attempted when the monitor is locked, a key mark  is displayed for around 5 seconds. (See page 21)

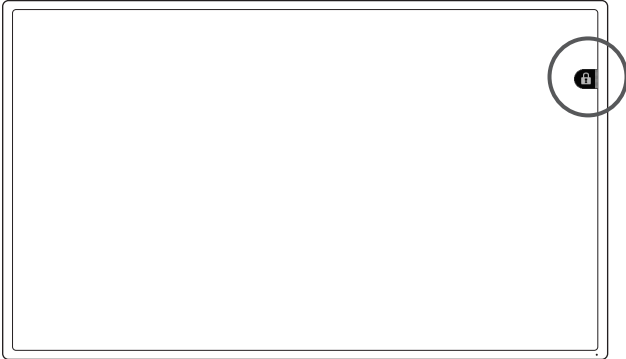

Operation lock is enabled.
A key mark is displayed on the screen and it disappears after around 5 seconds.

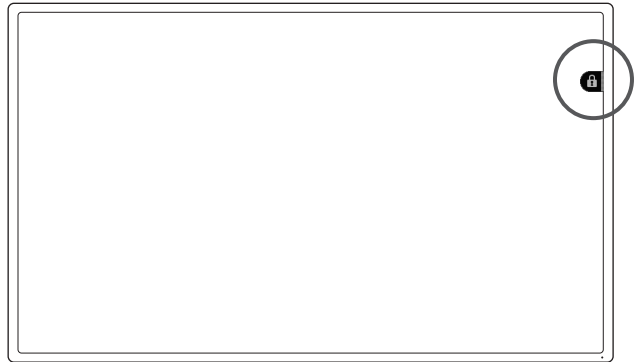

! Caution

- When the MENU button is pressed, the menu screen appears and only the disable operation lock and exit menu operation are possible.

■ Locking operation

1. Press the MENU button.
The menu screen appears.

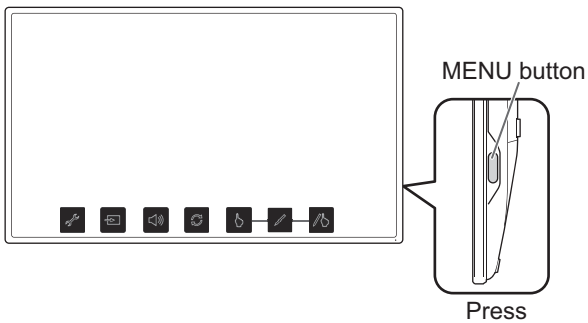

2. While touching [Volume], touch [Finger-only mode] for at least 1 second.

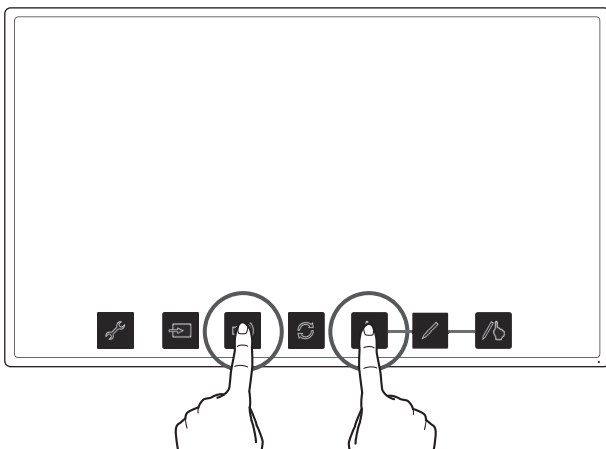

TIPS

- If the menu screen is displayed when locked, the invalid action mark is displayed.

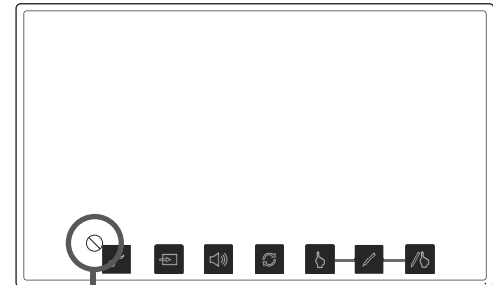

Invalid action mark

■ Disabling operation lock

1. Press the MENU button.

The menu screen is displayed.

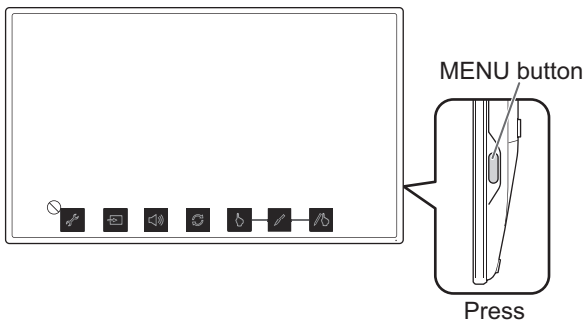

2. While touching [Volume], touch [Finger-only mode] for at least 1 second.

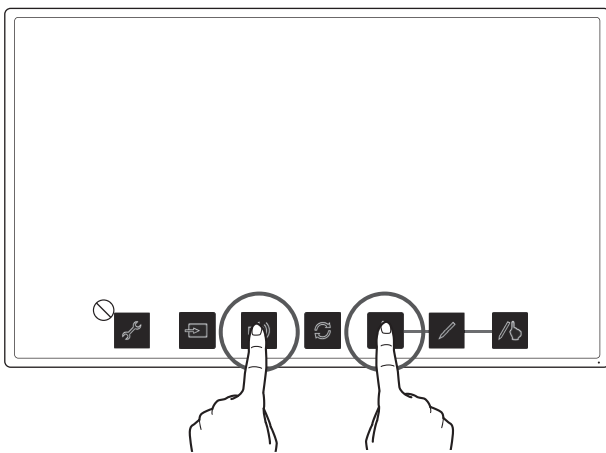

Operation lock is disabled.

Monitor status indicators

Monitor status is displayed at the top right of the screen.

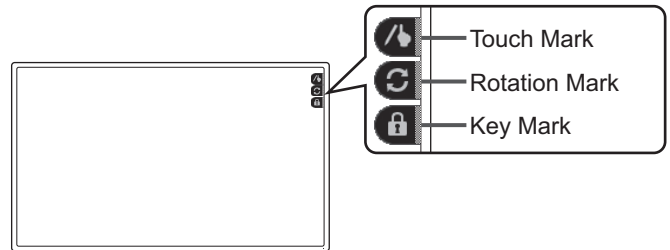

Touch Mark

The touch mark displays the current touch action mode.

Finger/pen mode

This mark is displayed during finger/pen mode.

Pen-only mode

This mark is displayed during pen-only mode.

Finger-only mode

This mark is displayed during finger-only mode.

After being set, it can be set so that it is only displayed for around 5 seconds. (See page 19.)

Rotation Mark

This mark is displayed when the rotate function is enabled.

After being set, it can be set so that it is only displayed for around 5 seconds. (See page 19.)

Key Mark

When operation lock (See page 20) is set, the mark is displayed for around 5 seconds when the screen is touched. It can be set to display constantly. (See page 19.)

TIPS

- The display position can be changed from the menu screen. (See page 19)
- These marks are not displayed while the menu screen is displayed.

Troubleshooting

If you are experiencing any problem with your display, before calling for service, please review the following troubleshooting tips.

There is no picture or sound.

- Are the AC adapter and power cord connected correctly? (See page 10.)
- Is the power on? (See page 13.)

There is a picture but no sound.

- Make sure the volume is not set to minimum. (See page 18.)
- Is the sound muted? (See page 18.)
- When headphones are connected, no sound will come from the speakers. (See page 10.)
- No sound will come from the speakers when the monitor is in standby mode (when the power LED is orange). (See page 13.)

The video does not appear.

- Is the cable certified for HDMI or DisplayPort? The monitor will not work unless a standards-compliant cable is used.
- Is the input signal compatible with this monitor? (See page 25.)
- Is the monitor connected correctly to the PC?
- Is the PC turned on?
- Is the PC in power-saving mode? Try pressing a key on the keyboard or moving the mouse.
- Turn off the LCD monitor power, wait 5 seconds or longer, and then turn the power on again.

The video does not appear properly.

- If a powerful amount of strain is exerted on the touch display, a portion of the display may remain on the screen. In this situation, turn off the monitor power, wait 5 seconds or longer, and then turn the power on again.

The touch panel does not respond.

- Is the USB cable connected properly? (See page 10.)
- The touch panel may not work properly if there is a large contact area (e.g. if the screen is touched with the palm of the hand).
- Is the monitor in pen-only mode? Touch action is disabled in pen-only mode. (See page 14, page 18.)
- Is the monitor in finger-only mode? You cannot touch the screen with the touch pen when in finger-only mode. (See page 14, page 18)
- Are monitor operations locked? (See page 20.)
- When there is no signal input to the LCD monitor, actions on the touch panel are not possible. Please operate the PC using the mouse and keyboard.

The response of the touch screen is slow.

Some parts of the screen do not respond.

- When starting your computer or connecting the USB cable, do not touch the touch panel.
- When starting the LCD monitor, do not touch the screen. If the screen is touched, the monitor may not function correctly. In this situation, turn off the LCD monitor power, wait 5 seconds or longer, and then turn the power on again.
- While the menu screen is displayed, touch actions are not possible other than those for the menu screen. First exit the menu screen and then perform the operation.
- There may be no response if the included touch pen and your hand on the screen are too close. In this situation, perform the operation with the pen and your hand separated farther apart.

Specifications

■Product Specifications

Model		LL-S201A
LCD component		20" Class [19-1/2 inch (49.5cm) diagonal] TFT LCD
Max. resolution	(pixels)	1920 x 1080
Max. colors		Approx. 16.77 million colors
Pixel pitch		0.225 mm (H) × 0.225 mm (V)
Viewing angle		178° right/left/up/down (contrast ratio ≥ 10)
Screen active area		inch (mm) 17 x 9-9/16 (432 x 243)
Plug and play		VESA DDC2B
Color adjustment menu	Image quality	Normal/Pen Writing/Game/Multimedia/User
	Color temperature	9000K, 7500K, 6500K, 5000K, and 4200K (With individual RGB adjustment and adjustment reset functions)
Input terminals	HDMI	x 1 (HDMI/MHL)
	DisplayPort	x 1
Output terminals	Headphones	φ3.5 mm mini stereo jack x 1
Speaker output		1 W + 1 W
Touch Panel	Touch screen system	Capacitive
	USB (for touch panel communication)	x1, microUSB Type B Ver.1.1
	Maximum touch points	10 points
Power requirement		AC 100 V - 240 V, 50/60 Hz (when using the supplied AC adapter), DC 19 V
Operating temperature		32°F to 95°F (0°C to 35°C)
Operating humidity		20% to 80% (no condensation)
Power consumption (During normal operation/when MHL charging/during standby) *		26 W / 35 W / 0.5 W (when using the supplied AC adapter)
Dimensions (excluding protrusions)		inch (mm) Approx. 18-1/4 (W) x 1 (D) x 10-13/16 (H) (463.8 x 25.2 x 274.8)
Weight		lbs. (kg) Approx. 5.07 (2.3) (excluding the stand) Approx. 6.39 (2.9) (including on stand)

* When the DisplayPort input terminal and Micro-USB terminal are connected

As a part of our policy of continuous improvement, SHARP reserves the right to make design and specification changes for product improvement without prior notice. The performance specification figures indicated are nominal values of production units. There may be some deviations from these values in individual units.

Specifications

■ Dimensional Drawings

Note that the values shown are approximate values.

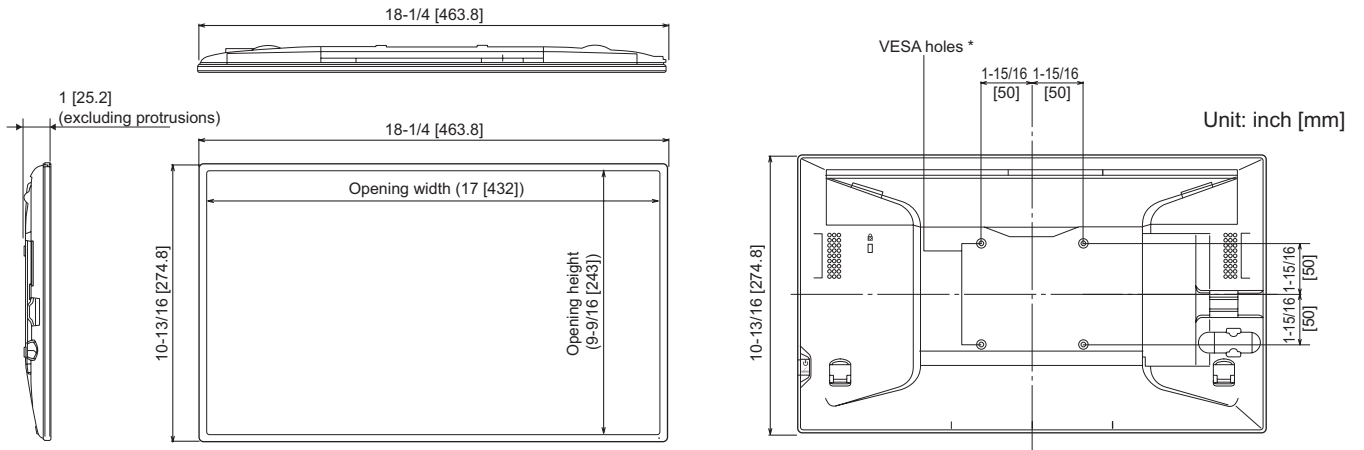

- * Use a VESA-compliant mounting bracket capable of supporting 4 times the weight of the monitor.
- * When attaching a VESA-compliant mounting bracket, use M4 screws that are 3/16inch to 1/4inch (4 to 6 mm). longer than the thickness of the mounting bracket.
- * When mounting the monitor on a wall or ceiling, ensure that the mounting location is capable of supporting 4 times the weight of the monitor (e.g. a concrete wall or column).

■ Standing position

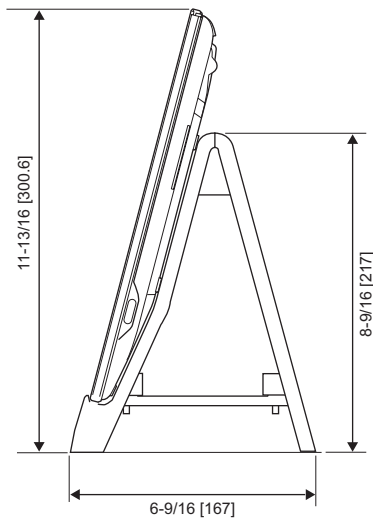

■ Pen writing position

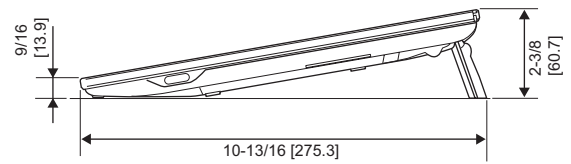

■Supported frequency

Resolution	Frame rate	Remarks
640×480	60Hz	VGA
800×600	60Hz	SVGA
1024×768	60Hz	XGA
720×480p	59.94/60Hz	
1280×720p	50/59.94/60Hz	
1920×1080p	50/59.94/60Hz	
720×576p	50Hz	

- * All are compliant only with non-interlaced.
- * Each is scaled to 16:9 and displayed using the full screen.
- * Depending on the connected PC, images may not be displayed properly even if the compatible signal described above is input.

■DDC (plug and play)

The monitor supports the VESA DDC (Display Data Channel) standard.

DDC is a signal standard for plug and play between monitors and computers. Information about resolution and other parameters is exchanged between the two. This function can be used if the computer supports DDC and it has been configured to detect plug-and-play monitors.

There are several types of DDC, depending on the communication method used. This monitor supports DDC2B.

■HDMI input terminal pins

(HDMI™ Connector)



No.	Function	No.	Function
1	TMDS data 2+	11	TMDS clock shield
2	TMDS data 2 shield	12	TMDS clock-
3	TMDS data 2-	13	CEC
4	TMDS data 1+	14	N.C.
5	TMDS data 1 shield	15	SCL
6	TMDS data 1-	16	SDA
7	TMDS data 0+	17	DDC/CEC GND
8	TMDS data 0 shield	18	+5V
9	TMDS data 0-	19	Hot-plug detection
10	TMDS clock+		

■DisplayPort input terminal pins

(DisplayPort 20 pin)

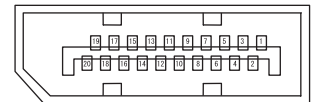

No.	Function	No.	Function
1	MainLane 3-	11	Gnd
2	Gnd	12	MainLane 0+
3	MainLane 3+	13	Gnd
4	MainLane 2-	14	Gnd
5	Gnd	15	Aux +
6	MainLane 2+	16	Gnd
7	MainLane 1-	17	Aux -
8	Gnd	18	Hot-plug detection
9	MainLane 1+	19	Gnd
10	MainLane 0-	20	3.3 V

SHARP[®]
SHARP CORPORATION