



The Bose® Wave® Radio

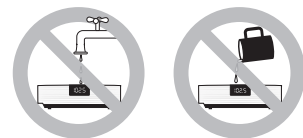
Owner's Guide

October 17, 2001

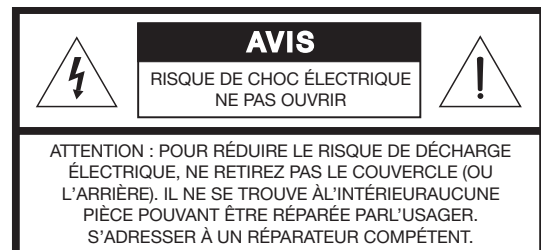
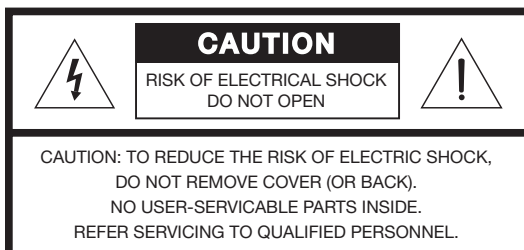
AM255380_01_v.pdf

Important Safety Information

- WARNING:** To reduce the risk of fire or electric shock, do not expose the Wave® radio to rain or moisture.



As with any electronic product, use care not to spill liquids into any part of the radio. Liquids can cause a failure and/or a fire hazard.



These CAUTION marks are located on the bottom of your Wave radio:



The lightning flash with arrowhead symbol, within an equilateral triangle, is intended to alert the user to the presence of uninsulated dangerous voltage within the system enclosure that may be of sufficient magnitude to constitute a risk of electric shock.



The exclamation point within an equilateral triangle, as marked on the system, is intended to alert the user to the presence of important operating and maintenance instructions in this owner's guide.

- CAUTION:** To prevent electric shock, match wide blade of plug to wide slot, insert fully.
- ATTENTION:** Pour éviter les chocs électriques, introduire la lame la plus large de la fiche dans la borne correspondante de la prise et pousser jusqu'au fond.
- WARNING:** Keep the remote control battery away from children. It may cause a fire or chemical burn if mishandled. Do not recharge, disassemble, heat above 100°C (212°F), or incinerate. Dispose of used battery promptly. Replace only with a battery of the correct type and model number.
- WARNING:** No naked flame sources, such as lighted candles, should be placed on the apparatus.

Batteries

Please dispose of used batteries properly, following any local regulations. Do not incinerate.

Please read this owner's guide

Please take the time to follow this owner's guide carefully. It will help you set up and operate your radio properly, and enjoy all of its advanced features. Save your owner's guide for future reference.

- Note:** DO NOT place the Wave radio on any heat-sensitive surface, such as the finished surface of fine furniture. Like all electrical equipment, it generates some heat.

- 1. Read these instructions** – for all components before using this product.
- 2. Keep these instructions** – for future reference.
- 3. Heed all warnings** – on the product and in the owner's guide.
- 4. Follow all instructions.**
- 5. Do not use this apparatus near water or moisture** – Do not use this product near a bathtub, washbowl, kitchen sink, laundry tub, in a wet basement, near a swimming pool, or anywhere else that water or moisture are present.
- 6. Clean only with a dry cloth** – and as directed by Bose® Corporation. Unplug this product from the wall outlet before cleaning.
- 7. Do not block any ventilation openings. Install in accordance with the manufacturer's instructions** – To ensure reliable operation of the product and to protect it from overheating, put the product in a position and location that will not interfere with its proper ventilation. For example, do not place the product on a bed, sofa, or similar surface that may block the ventilation openings. Do not put it in a built-in system, such as a bookcase or a cabinet that may keep air from flowing through its ventilation openings.
- 8. Do not install near any heat sources, such as radiators, heat registers, stoves or other apparatus (including amplifiers) that produce heat.**
- 9. Do not defeat the safety purpose of the polarized or grounding-type plug. A polarized plug has two blades with one wider than the other. A grounding-type plug has two blades and a third grounding prong. The wider blade or third prong are provided for your safety. If the provided plug does not fit in your outlet, consult an electrician for replacement of the obsolete outlet.**
- 10. Protect the power cord from being walked on or pinched, particularly at plugs, convenience receptacles, and the point where they exit from the apparatus.**
- 11. Only use attachments/accessories specified by the manufacturer.**
- 12. Use only with the cart, stand, tripod, bracket or table specified by the manufacturer or sold with the apparatus. When a cart is used, use caution when moving the cart/apparatus combination to avoid injury from tip-over.**
- 13. Unplug this apparatus during lightning storms or when unused for long periods of time** – to prevent damage to this product.
- 14. Refer all servicing to qualified service personnel. Servicing is required when the apparatus has been damaged in any way: such as power-supply cord or plug is damaged; liquid has been spilled or objects have fallen into the apparatus; the apparatus has been exposed to rain or moisture, does not operate normally, or has been dropped** – Do not attempt to service this product yourself. Opening or removing covers may expose you to dangerous voltages or other hazards. Please call Bose to be referred to an authorized service center near you.
- 15. To prevent risk of fire or electric shock, avoid overloading wall outlets, extension cords, or integral convenience receptacles.**
- 16. Do not let objects or liquids enter the product** – as they may touch dangerous voltage points or short-out parts that could result in a fire or electric shock.
- 17. See product enclosure bottom for safety related markings.**

Information about products that generate electrical noise

If applicable, this equipment has been tested and found to comply with the limits for a Class B digital device, pursuant to Part 15 of the FCC rules. These limits are designed to provide reasonable protection against harmful interference in a residential installation. This equipment generates, uses, and can radiate radio frequency energy and, if not installed and used in accordance with the instructions, may cause harmful interference to radio communications. However, this is no guarantee that interference will not occur in a particular installation. If this equipment does cause harmful interference to radio or television reception, which can be determined by turning the equipment off and on, you are encouraged to try to correct the interference by one or more of the following measures:

- Reorient or relocate the receiving antenna.
- Increase the separation between the equipment and receiver.
- Connect the equipment to an outlet on a different circuit than the one to which the receiver is connected.
- Consult the dealer or an experienced radio/TV technician for help.

Note: *Unauthorized modification of the receiver or radio remote control could void the user's authority to operate this equipment.*

This product complies with the Canadian ICES-003 Class B specifications



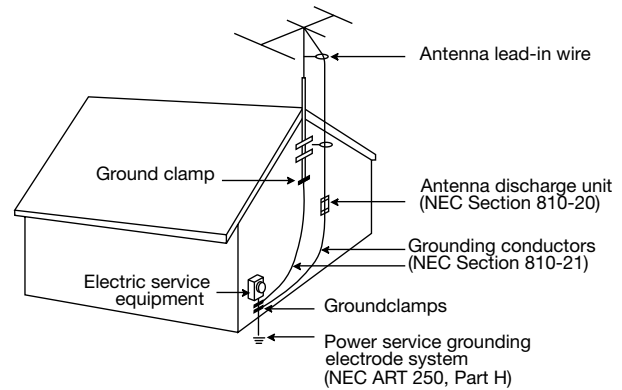
Important Safety Information

- 18. Use proper power sources** – Plug the product into a proper power source, as described in the operating instructions or as marked on the product.
- 19. Avoid power lines** – Use extreme care when installing an outside antenna system to keep from touching power lines or circuits, as contact with them may be fatal. Do not install external antennas near overhead power lines or other electric light or power circuits, nor where an antenna can fall into such circuits or power lines.
- 20. Ground all outdoor antennas** – If an external antenna or cable system is connected to this product, be sure the antenna or cable system is grounded. This will provide some protection against voltage surges and built-up static charges.

Section 810 of the National Electrical Code ANSI/NFPA No. 70 provides information with respect to proper grounding of the mast and supporting structure, grounding of the lead-in wire to an antenna discharge unit, size of grounding conductors, location of antenna-discharge unit, connection to grounding electrodes, and requirements for the ground electrode. Refer to the antenna grounding illustration on this page.

Antenna grounding

Example of antenna grounding as per National Electrical Code, ANSI/NFPA 70.



Note to CATV system installer

This reminder is provided to call the CATV system installer's attention to Article 820-40 of the NEC (of USA) that provides guidelines for proper grounding. In particular, it specifies that the cable ground shall be connected to the grounding system of the building, as close to the point of cable entry as is practical.

Contents

Setting Up Your Wave® Radio	
Before you begin	7
Unpacking the carton	8
Selecting a location for your radio	8
Installing the battery	9
Connecting the power cord	10
Adjusting the antennas	10
Receiving cable radio signals as an option	10
Setting up the remote control	11
Connecting other components	13
Using other components	13
Operating Your Wave Radio	
Operating the remote control	15
Operating the radio control panel	16
Reading the clock display	17
Setting the time	17
Customizing the display	18
Listening to the radio	19
Reading the radio display	20
Setting the alarms	21
Using the Alarms	22
Maintaining Your Wave Radio	
Taking care of your Wave radio	23
Cleaning your radio	23
Replacing the batteries	23
Technical information	23
Power rating	23
Dimensions	23
Weight	23
Troubleshooting	24
Customer service	24
Warranty period	24
Index	
Bose® Corporation Sales and Service	

For your records

The serial number is located on the bottom of your radio.

Wave radio serial number: _____

Purchase date: _____

We suggest you keep your sales receipt and warranty card together with this owner's guide.

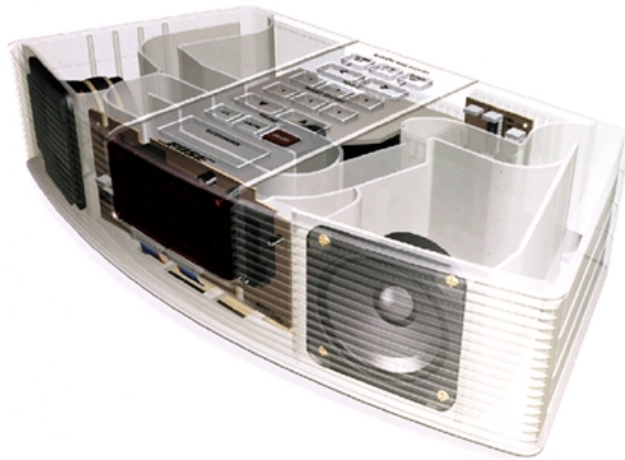


Setting Up Your Wave® Radio

Before you begin

Thank you for purchasing the Bose® Wave radio.

Fourteen years of research by Bose Corporation bring you the benefits of award-winning patented acoustic waveguide speaker technology. Using this technology, a tube efficiently transfers energy from a small loudspeaker to the outside air over a whole range of bass notes. And, by folding long waveguides into intricate patterns, they fit into products small enough to be placed comfortably in your home. There is a 37-inch (93.5-cm) long waveguide inside the Wave radio's enclosure, enabling this tabletop radio to produce room-filling sound with full, deep bass.



Your Wave radio also includes:

- Integrated system design for high acoustic quality requiring no complex adjustments
- A high performance stereo tuner with 6 AM and 6 FM station presets
- Two independent alarms, with battery backup power to save the settings for wakeup during power loss
- A credit card-size infrared remote control with optional mounting strip
- Inputs for an additional sound source, such as a CD or tape player

To fully appreciate all of these features, please take the time to follow this owner's guide carefully. It helps you set up and operate your radio and enjoy its high-fidelity sound.

Unpacking the carton

Carefully unpack your system. Save all packing materials for possible future use. The original packing materials provide the safest way to transport your Wave radio. If any part of the product appears damaged, do not attempt to use it. Notify Bose® Customer Service immediately. (See phone numbers on the inside back cover.)

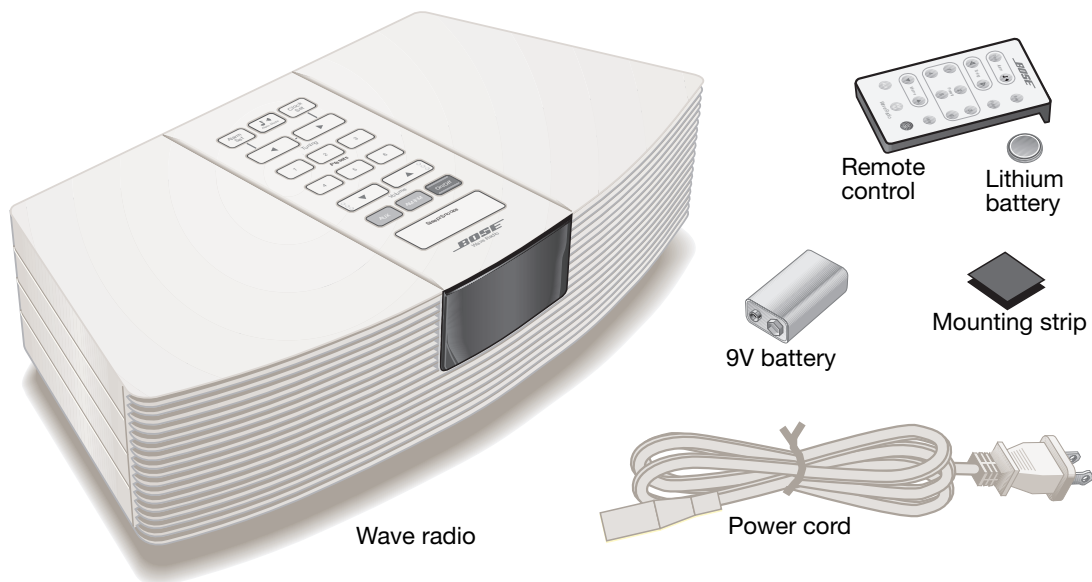
Check to be sure your Wave radio contains the parts identified in Figure 1.

🎵 **Note:** Find the serial number on the bottom of your radio. Write it on your warranty card and in the space provided on page 5.

Figure 1

Carton contents:

- Wave radio
- Power cord
- 9V battery
- Remote control
- Lithium battery
- Mounting strip



Selecting a location for your radio

Please keep these guidelines in mind when selecting a location for your radio:

- Place the radio on a table or other flat surface.
- Do not place it on a metal surface or table that could interfere with AM reception.
- Do not place it on a heat-sensitive surface. Like all electrical equipment, it generates some heat.
- To ensure reliable operation of the product and to protect it from overheating, put the product in a position and location that will not interfere with its proper ventilation.
- Do not use the radio in a damp location. It is important to prevent moisture from getting into the unit.
- Locate it within 2 feet (61 cm) of a wall for best bass performance.
- Place it across the room from where you will be listening to enjoy maximum performance of the Wave radio.

Feel free to place and position it where you find the sound most pleasing.

Installing the battery

⚠ WARNING: Keep the remote control battery away from children. It may cause a fire or chemical burn if mishandled. Do not recharge, disassemble, heat above 100°C (212°F), or incinerate. Dispose of used battery promptly. Replace only with a battery of the correct type and model number.

The 9V battery maintains clock and alarm settings and operates the Wave radio's alarm system for approximately 48 hours during a power loss, or while the radio is temporarily unplugged. Operating without this battery results in the loss of clock and alarm settings, and station presets in the event of a power loss, but does not harm the radio.

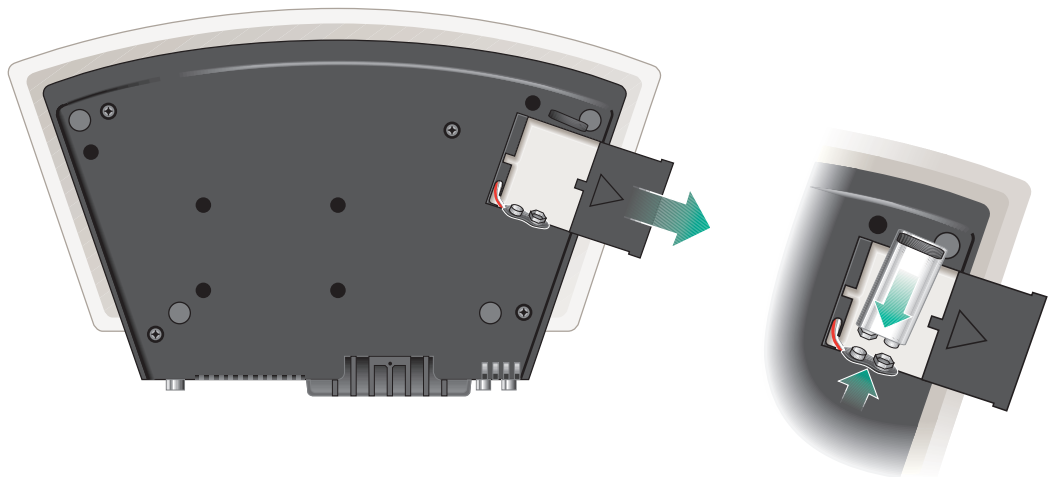
Use a standard 9V battery (IEC 6F22 in Europe), available at most retail stores.

🎵 Note: The battery does not provide power for Wave radio operation or for the display.

1. Carefully turn your radio upside down.
2. Locate the battery compartment on the bottom (Figure 2).
3. Press the arrow on the cover to slide the compartment open.
4. Lift the battery clip out of the compartment and align it with the battery as shown.
5. Snap the terminals together firmly.
6. Place the battery in the compartment and slide the cover closed. Then turn the radio right side up.

Figure 2

Installing the battery

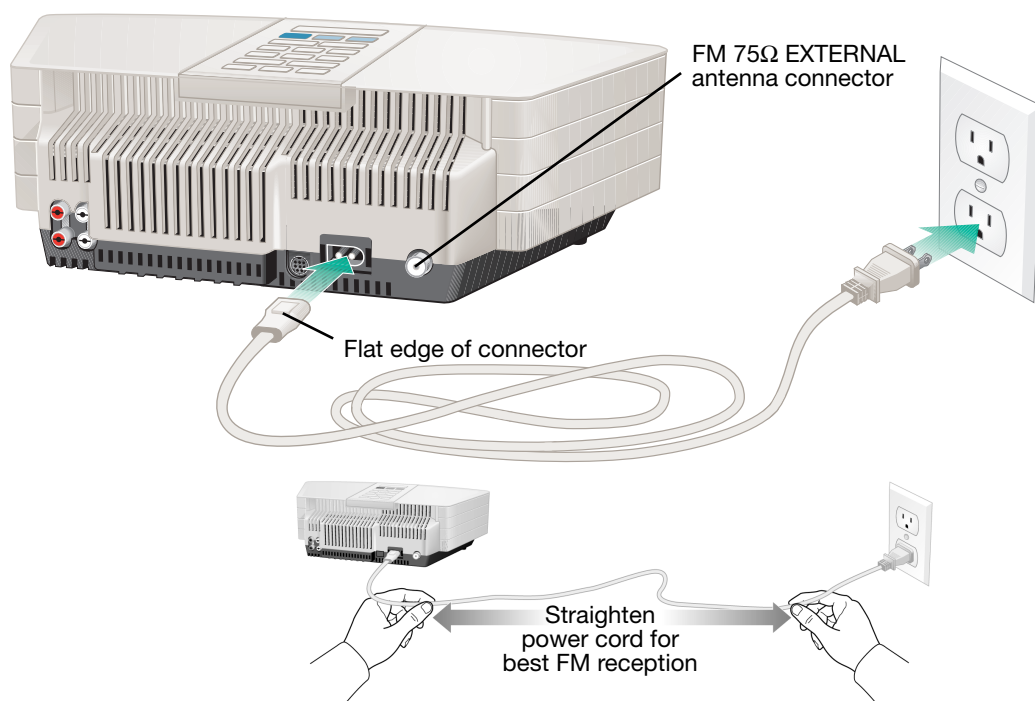


Connecting the power cord

1. Untie and straighten the bundled power cord completely to ensure the best FM reception. The FM antenna is built into the power cord.
2. Plug the small end of the power cord into the power jack on the back of your radio (Figure 3). The connector is shaped to fit in only one direction. Line up the flat edge of the plug with the flat edge on the side of the jack.
3. Plug the other end of the power cord into an electric outlet. The display panel lights and the time display begins flashing.
4. Press the Clock Set button once to stop the flashing. See “Setting the time” on page 17 to set the clock.

Figure 3

Connecting the power cord



Adjusting the antennas

With the FM antenna built into the power cord, adjusting the cord position affects FM radio reception slightly. With the AM antenna built into the radio, turning the radio more to one side or the other adjusts AM reception slightly.

Receiving cable radio signals as an option

To connect your radio to the FM signal available from some cable TV companies, contact your cable provider for assistance.

The cable screws onto threads of the FM 75Ω EXTERNAL antenna connector on the back of the Wave radio (Figure 3). To make this connection easier, you may want to obtain a screw-on to push-on RF adapter (available at electronic stores).

⚠ CAUTION: Make sure the installation includes a signal splitter. It is important that only the FM band, not the cable TV band, is transmitted to the radio. It is necessary to use a splitter that filters the signal to prevent any re-emissions of the TV spectrum through the radio.

Setting up the remote control

WARNING: Keep the remote control battery away from children. It may cause a fire or chemical burn if mishandled. Do not recharge, disassemble, heat above 100°C (212°F), or incinerate. Dispose of used battery promptly. Replace only with a battery of the correct type and model number.

Your remote control may be one of two types. Each is identified by the way the battery compartment unlocks to install or replace the battery (Figure 4 or Figure 5).

1. Place the remote control face down on a flat surface.
2. If your remote has a slot on the back (Figure 4), follow step A. Otherwise, follow step B and refer to Figure 5:
 - A. Insert the tip of a ballpoint pen into the slot. Push to the side as shown and hold. Slide the battery compartment open with your finger.
 - B. Using your finger, push the tab lock to the side as shown and hold. Slide the battery compartment open.

Figure 4

Locating the slot-type safety lock

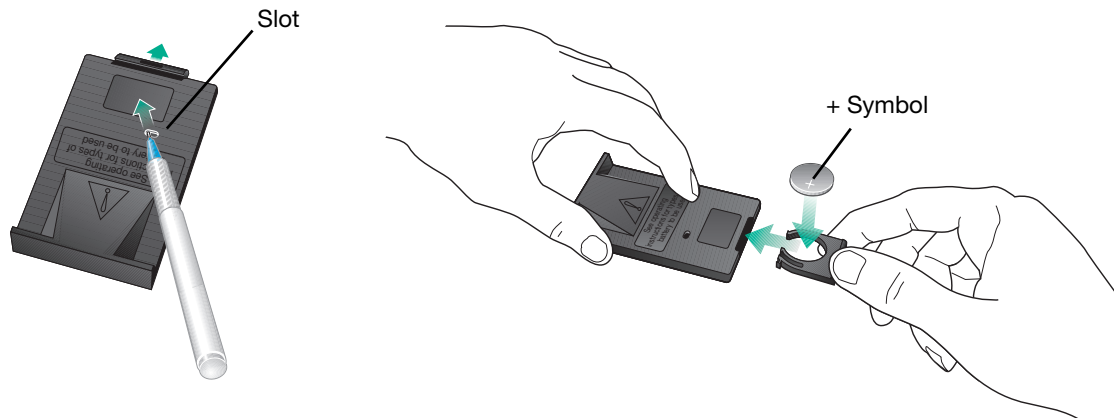
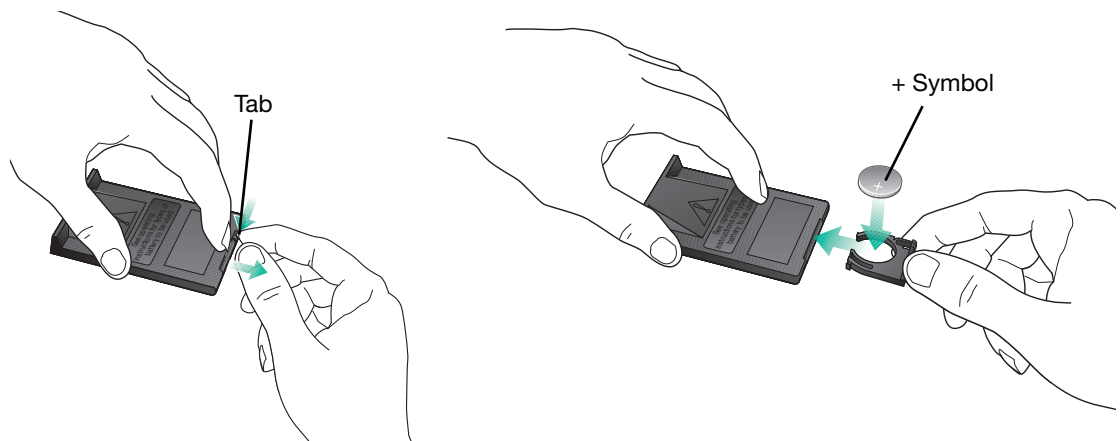


Figure 5

Locating the tab-type safety lock

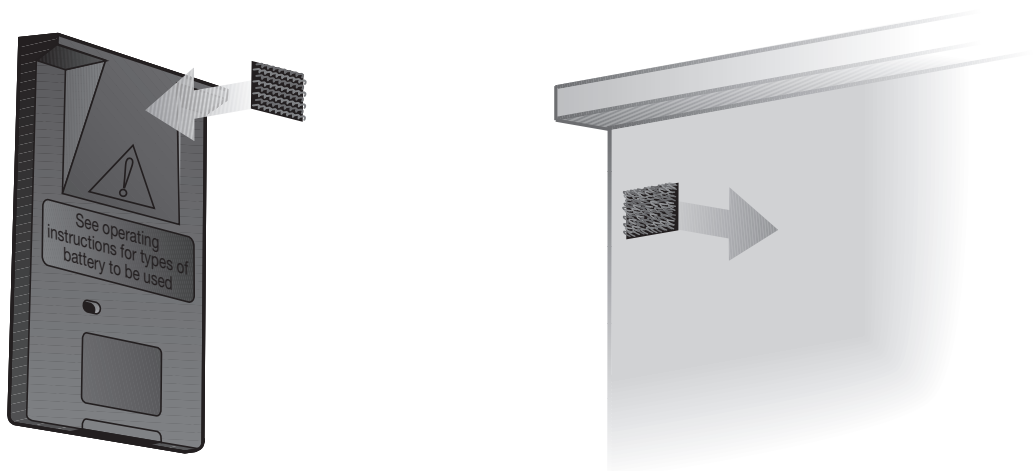


Setting Up Your Wave® Radio

- ♪ **Note:** Use only a Duracell, Eveready, Maxell, or Toshiba CR2032 or DL2032 lithium battery (available at electronics stores). If you have difficulty finding a replacement battery, contact Bose® Customer Service. (See phone numbers on the inside back cover.)
3. Keeping the remote control face down, insert the new battery into the compartment with the + symbol facing up.
 4. Gently slide the battery compartment closed. It locks automatically.
 5. Use the supplied mounting strip if you want to attach the remote to a surface in your listening room. Peel off the protective backing to stick one piece to the back of the remote and the other to the selected surface (Figure 6).

Figure 6

Installing the mounting strip for the remote control



⚠ CAUTION: Danger of explosion if battery is incorrectly replaced. Replace only with the same or equivalent type.

Connecting other components

You can use your Wave radio to improve the sound of a CD player, tape player, or TV. You can also use your radio as extension speakers for a Bose® Lifestyle® music system. Connect one of these components to the right and left AUX IN jacks.

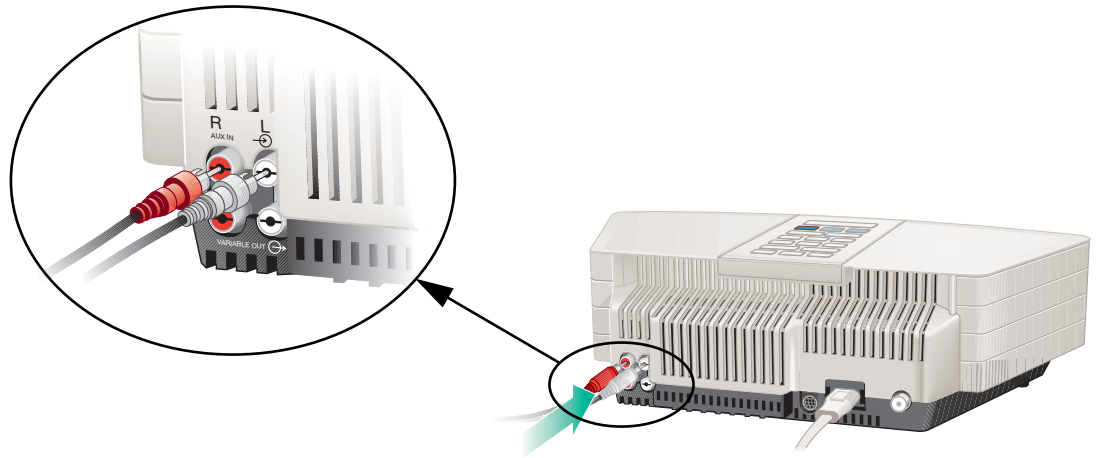
To play your radio through external speakers, connect Bose powered speakers to the radio's right and left VARIABLE OUT jacks. Audio cables for these connections are available at electronics stores, or by calling Bose Product and Technical Support.

Most audio cables are color coded. Match the red plug to the R (red) jack and the black or white plug to the L (white) jack (Figure 7).

Note: Connecting components or speakers to the VARIABLE OUT jacks shuts off the radio speakers.

Figure 7

Connecting another component






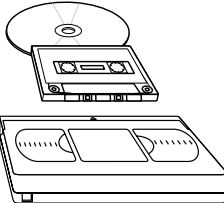


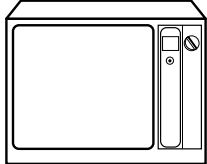






Using other components

Select your CD player, tape player, or other auxiliary source by pressing the AUX button. Adjust the listening volume with the Volume buttons. Control all other functions, including on/off, at the source, referring to its owner's manual, if necessary.

Control your auxiliary powered speakers from the Wave radio. If these speakers have a volume control, you may use it.

Note: Recording from your Wave radio is not recommended. Connecting a tape recorder to the VARIABLE OUT jacks shuts off the radio speakers, preventing you from monitoring the recording volume.

Setting Up Your Wave® Radio

Component	Cable	Connection at component	Connection at Wave radio	Notes
Portable CD or tape player 	One miniplug-to-stereo audio cable 	Headphone jack For best sound, set the player volume control to approximately 3/4 of maximum volume.	AUX IN jacks 	
CD player, tape deck, or VCR 	One stereo audio cable 	Audio output jacks If there are two sets of outputs (fixed and variable), use fixed so that the volume can be controlled from the radio.	AUX IN jacks 	Recording from your Wave radio is not recommended because connecting cables to the VARIABLE OUT jacks shuts off the radio speakers, preventing you from monitoring the recording volume.
Television 	Use a standard RCA cable for a TV with stereo output jacks. Use a standard "Y" adapter for a TV with a single (mono) audio output jack. You may need a special adapter (such as a miniplug stereo audio cable) for a TV with a headphone outlet.	Audio output jacks If there are two sets of outputs (fixed and variable), use fixed so that the volume can be controlled from the radio.	AUX IN jacks 	To make sure the sound seems to come from the screen, place the Wave radio close to the TV.
Bose® Lifestyle® music system 	Stereo cable with male-to-male RCA plugs. 	TAPE (REC) jacks	AUX IN jacks 	
Powered speakers with volume control 	Use the audio input cable that came with your speakers.	Speaker system input (as described in the speaker owner's guide)	VARIABLE OUT jacks 	If your powered speaker audio input cable has three connectors on each end, use only the two connectors that look alike to connect to the Wave radio outputs. DO NOT USE THE THIRD CONNECTOR. Connecting powered speakers to the VARIABLE OUT jacks shuts off the radio speakers.

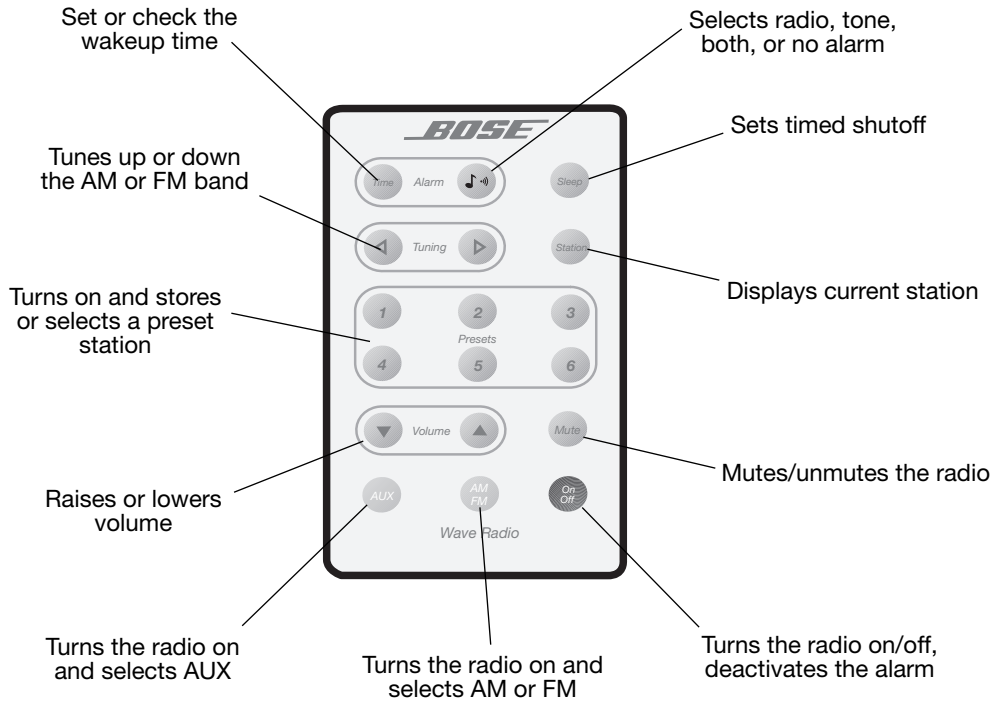
Operating Your Wave® Radio

Operating the remote control

You can use the remote control (Figure 8) to operate the most frequently used functions of the radio and alarms. Aim the remote control at the display of your Wave radio. Use the remote buttons in the same way you use the radio control panel. The remote normally works up to 20 feet (6.1 m) in front of the radio, and 6 feet (1.8 m) to either side. Replace the remote control battery when it stops operating, or its range seems reduced (normally every year or two). Keep in mind that lighting and other room conditions, in addition to battery age, can affect the operating range of an infrared remote control.

Figure 8

The Wave radio remote



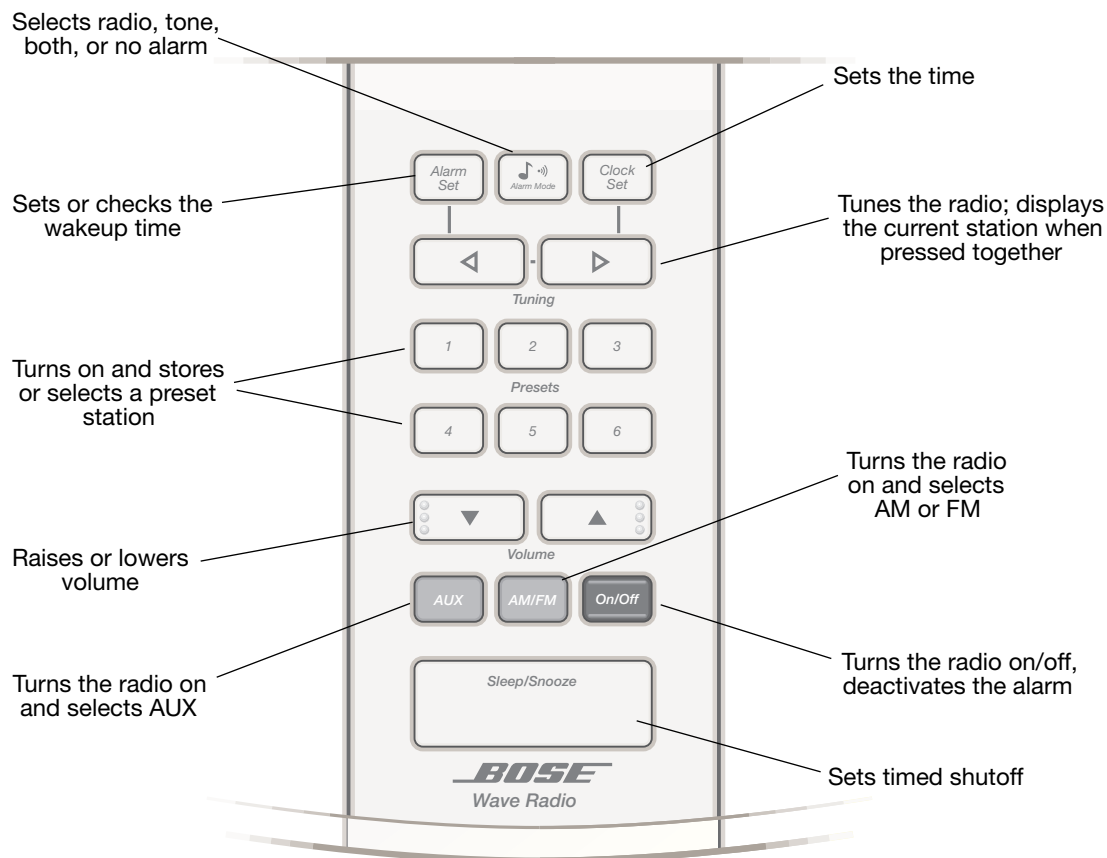
Operating the radio control panel

Most of the functions of the clock and the radio are operated by similar buttons on the control panel or the remote control (Figure 9). You can access additional functions by pressing two control panel buttons simultaneously (such as both *Tuning* buttons to display the station), which requires a separate button on the remote (*Station*).

The control panel *On/Off* and *VOLUME* buttons have raised ridges to help you locate these frequently used buttons.

Figure 9

The Wave radio control panel



Reading the clock display

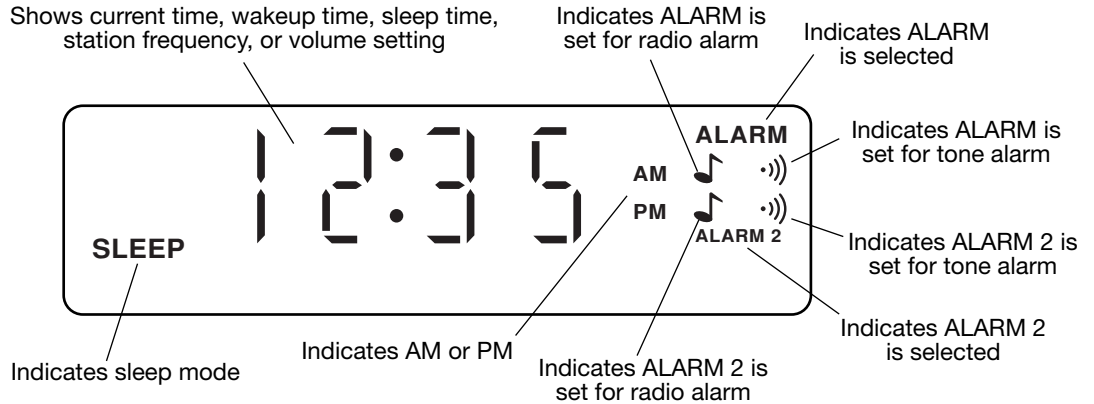
You can set the Wave radio to always show either the clock display (Figure 10) or the radio display when the radio is on.

To change the display mode, press and hold *Clock Set*, and then press the *AM/FM* button.

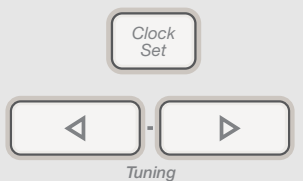

To make additional changes to the display, see “Customizing the display” on page 18.

Figure 10

The clock display



Setting the time

Function	Control panel	Remote control
<p>To set the clock – Hold down the <i>Clock Set</i> button and press <i>Tuning</i> up (4) or down (3). The time display changes slowly at first, then faster. Release the <i>Tuning</i> button to stop.</p>	 <p><i>Clock Set</i></p> <p><i>Tuning</i></p>	 <p>Use the control panel to select this feature.</p>

Customizing the display

Function

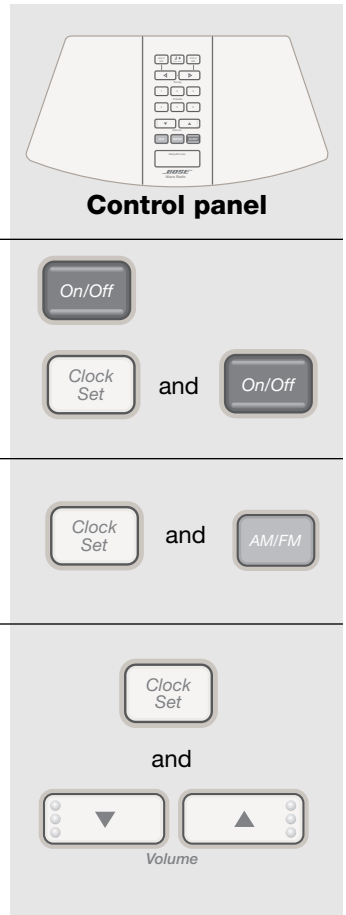
To set AM/PM (12 hour) or Military (24 hour) time – Press the *On/Off* button once to turn your Wave radio off. Press and hold *Clock Set*, and then press *On/Off* to switch between AM/PM (12 HR) or military (24 HR) formats

To set the display to clock or radio mode – In the clock mode, the display shows the time while the radio is on; In radio mode, the display shows the selected radio station. With the radio turned on, press and hold *Clock Set* and then press the *AM/FM* button to switch between clock and radio modes.




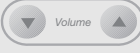



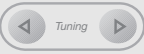

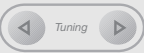









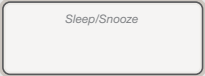

To adjust the display brightness – In low light situations, the display dims automatically. To adjust the brightness level for the automatic dim setting:

- Hold down the *Clock Set* button while pressing *Volume* up to view the 10 levels of increasing brightness.
- Hold down the *Clock Set* button while pressing *Volume* up or down to select you preferred setting.

The selected setting is retained by the radio with the 9V battery as backup in case of power loss.



Listening to the radio

Function	Control panel	Remote control
To turn on/off – Press once to turn on (to the last source played) or off. Or, press <i>AM/FM</i> or any <i>Presets</i> button to turn the radio on.		
To adjust the volume – While the radio is either on or off, press and hold either button to adjust the volume. The display shows the volume level, from 0 (silent) to 99 (loud).		
To select AM or FM – If the radio is off or in the AUX mode, press to select the radio. Press again to change between AM and FM.		
To tune in a station – Press and hold either button until the desired station is selected.		
To seek a station – Press and hold either button until you hear a beep. Release to find the next strong station.		
To preset up to 6 AM and 6 FM stations – Use the <i>Tuning</i> buttons to find the desired station. Then hold down any <i>Presets</i> button until you hear a beep. The station is now preset to that number.		
To select a preset station – Choose AM or FM. Press the <i>Presets</i> button for the station you want.		
To display the selected station – If the display is in clock mode and the radio is on, press both <i>Tuning</i> buttons (control panel) together or press <i>Station</i> (remote).		
To mute the sound – On the remote control ONLY, press to silence the radio. Press again to restore volume.	Use the remote control to select this function.	
To listen to a component connected to AUX – Press to turn on the radio in AUX mode. This does not turn on the component.		
To go to sleep listening to music – Press <i>Sleep</i> to set the automatic shutoff time. Initially, the display shows you the first setting of 75 minutes. Press again to change the automatic shutoff time to 60, 45, 30, 15, 10, 5, or 0.		

Reading the radio display

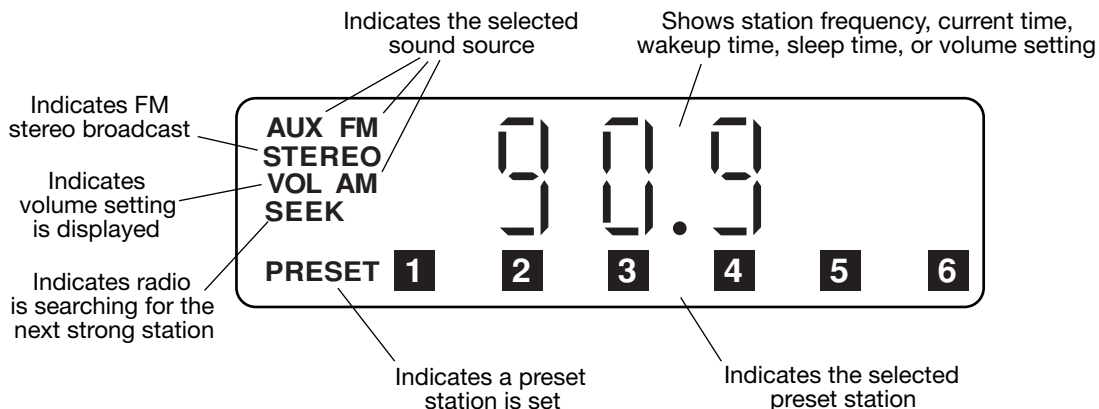
You can set the Wave radio to always show either the clock display or the radio display (Figure 11) when the radio is on.

To change the display mode, press and hold *Clock Set*, and then press the *AM/FM* button.

To make additional changes to the display, see “Customizing the display” on page 18.


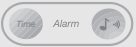
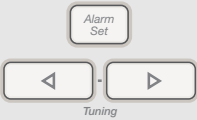

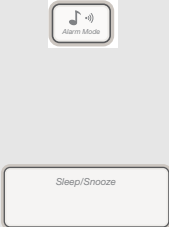
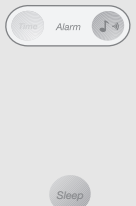





Figure 11

The radio display



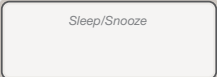


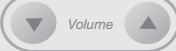





Setting the alarms

Note: There are two alarms indicated on the clock display as ALARM (primary) and ALARM 2 (secondary). You can set the wakeup time for either alarm with the radio on or off. The indicator for the selected alarm flashes when setting time or mode. The ALARM 2 indicator continues flashing for 10 seconds after setting ALARM 2.

Function	Control panel	Remote control
<p>To select which alarm to set – On the control panel, press and hold <i>Alarm Set</i>. Press <i>Alarm Mode</i> to select ALARM or ALARM 2. The indicator flashes for the alarm you are setting.</p> <p>On the remote, press <i>Time</i>. Press <i>Alarm</i> to select ALARM 2 or to return to ALARM. The indicator flashes for the alarm you are setting.</p>		
<p>To set the alarm time – On the control panel, hold down <i>Alarm Set</i> and press <i>Tuning up</i> () or down () . The time display changes slowly at first, then more quickly. Release <i>Tuning</i> to stop.</p> <p>On the remote, press <i>Time</i>. Press <i>Tuning up</i> () or down () . The time display changes slowly at first, then more quickly. Release <i>Tuning</i> to stop. Press <i>Time</i> to return to the current time display.</p>		
<p>To set the alarm mode – On the control panel, after selecting the alarm, release <i>Alarm Set</i> and press <i>Alarm Mode</i> to select one of the following alarm modes (Press <i>Alarm</i> on the remote):</p> <p>For tone only, press until you see the indicator.</p> <p>For radio only, press until you see the indicator.</p> <p>For tone and radio, press until you see both indicators .</p> <p>When the alarm tone sounds, press <i>Sleep/Snooze</i> to turn the radio on. Press <i>Sleep/Snooze</i> to pause the radio for 10 minutes.</p>		
<p>To cancel the alarm mode – Follow the directions for setting the alarm mode. Press <i>Alarm Mode</i> (control panel) or <i>Alarm</i> (remote) until the display shows no alarm mode indicators.</p>		
<p>To check the alarm setting – On the control panel, press and hold <i>Alarm Set</i> to see the ALARM wakeup time and the preset station. While holding <i>Alarm Set</i>, press <i>Alarm Mode</i> to see the ALARM 2 wakeup time and the preset station.</p> <p>On the remote, press <i>Time</i> to see the ALARM wakeup time. Press <i>Alarm</i> to see the ALARM 2 wakeup time. Press <i>Time</i> again to return the display to the current time. ALARM 2 flashes for 10 seconds.</p>		
<p>To wake to a preselected radio station – On the control panel, ONLY, select ALARM or ALARM 2. Press and hold <i>Alarm Set</i>, and then press one of the six station <i>Presets</i> buttons (you can change between AM and FM if needed). To clear the preset, press and hold <i>Alarm Set</i> and press the button for that preset again.</p>		<p>Use the control panel to select this feature.</p>

Using the Alarms

Function	Control panel	Remote control
<p>To stop the alarm – Press <i>On/Off</i>. The indicators remain lit. Or, if you do not press <i>On/Off</i>, the tone alarm shuts off in 30 minutes, the radio alarm shuts off in 60 minutes. The alarm automatically resets to repeat daily.</p>		
<p>To pause the alarm for 10 minutes – Press <i>Sleep/Snooze</i> or <i>Sleep</i> to have the radio alarm or tone alarm repeat in 10 minutes. When the alarm is in both radio and tone mode, press <i>Sleep/Snooze</i> or <i>Sleep</i> to pause the tone for 10 minutes and turn on the radio. Press <i>Sleep/Snooze</i> or <i>Sleep</i> again to silence the radio – the tone repeats in 10 minutes. You can repeat the pause cycle as many times as you want. If you do not press any button while the tone is sounding, it shuts off in 30 minutes.</p>		
<p>To set the volume of the radio alarm – The radio alarm turns on and gradually increases to the last volume setting used. You can select a volume setting with the radio on or off.</p>		
<p>To set the volume of the tone alarm – The tone alarm turns on and gradually increases to the last tone setting used. You can set a louder or softer tone by pressing <i>Volume</i> up or down while the tone is sounding.</p>		
<p>To use the alarm during a power loss – Press <i>On/Off</i> to silence the alarm. The backup battery runs the alarm for approximately 48 hours without AC power. To conserve power, only the tone alarm sounds even if the radio alarm is selected. Normal operation resumes when power is restored. Replace the 9V battery after an extended power loss.</p> <p>Note: <i>The Wave radio does not respond to remote control during a power loss.</i></p>		<p>Use the control panel to operate the alarm during a power loss.</p>

Maintaining Your Wave® Radio

Taking care of your Wave radio

The only necessary maintenance is periodic battery replacement and cleaning.


Cleaning your radio

Use only a dry cloth to clean the outside of the Wave radio. If necessary, you may use a soft-bristled attachment to gently vacuum the front of the radio.

Do not use any solvents, chemicals, or cleaning solutions containing alcohol, ammonia, or abrasives. Do not allow liquids to spill into any openings on the radio.

If liquids get into the product, turn the radio off. Call Bose® Customer Service as soon as possible to arrange for service. (See phone numbers on inside back cover.)

Replacing the batteries

 **WARNING:** *Keep the remote control battery away from children. It may cause a fire or chemical burn if mishandled. Do not recharge, disassemble, heat above 100°C (212°F), or incinerate. Dispose of used battery promptly. Replace only with a battery of the correct type and model number.*

To ensure correct operation of your Wave radio's alarm system, replace the 9V battery every year and following an extended power loss. A dead battery may leak and cause damage. Do not unplug your Wave radio from the power outlet while replacing the battery. If you do unplug it, you will need to reset the clock, alarm settings, and station presets. For further information on replacing the 9V battery, see "Installing the battery" on page 9.

For information on replacing the remote control battery, see "Setting up the remote control" on page 11.

Technical information

Power rating

USA/Canada: 120V ~ AC, 50/60 Hz

Dimensions

14"W x 8 1/4"D x 4 3/16"H (35.6 cm x 21.0 cm x 10.6 cm)

Weight

6.8 lb (3.1 kg)

Troubleshooting

Problem	What to do
Radio does not function	<ul style="list-style-type: none">• Make sure the power cord connector is inserted securely into the radio, matching the flat side of the connector to the flat side of the jack.• Make sure the power cord is fully plugged into an operating AC wall outlet.
No sound	<ul style="list-style-type: none">• Increase the volume.• Press the <i>Mute</i> button on the remote control to unmute the sound.• Check the connections for any auxiliary component.• Press <i>AUX</i> to hear a source connected to the AUX IN jacks.• Be sure that the component is turned on.
Remote control is inconsistent or does not work	<ul style="list-style-type: none">• Check battery and its polarity (+ and -).• Replace the battery, if necessary (See "Replacing the batteries" on page 23.).• Operate the remote control closer to the radio.• Check for interference from room lighting or sunlight, or dust or dirt on the lens. Try the radio in a different location.
AM reception is weak	<ul style="list-style-type: none">• Adjust the internal AM antenna by turning the radio slightly.• Try moving the radio farther from a television, fluorescent lights, dimmer switches, or other electronic equipment which generate electrical noise.• You may be in an area of weak AM signal coverage.
FM reception is weak	<ul style="list-style-type: none">• Extend the power cord as much as possible. The FM antenna is in the power cord.• Move the power cord to adjust the FM antenna.• If you still have problems with FM reception, you may need an external antenna. Call Bose® Product and Technical Support to request one.

Customer service

For additional help in solving problems, contact Bose Customer Service. See the inside back cover for Bose Corporation offices and phone numbers.

Warranty period

The Bose Wave radio is covered by a limited 1-year transferable warranty. Details of the warranty are provided on the warranty card that came with your radio. Please fill out the information section on the card and mail it to Bose.

Index

A

Acoustic Waveguide 7
ALARM 17, 21
ALARM 2 17, 21
alarm check 21
Alarm Mode 21
Alarm Set 21
alarm time 21
alarms 7, 22
alarms, setting 21
AM 15, 16, 19, 20
AM antenna 10, 24
AM reception 24
AM/FM 17
automatic dimming 18
automatic shutoff 19
AUX 13, 15, 16, 20, 24
AUX IN jacks 13, 14, 24
auxiliary source 13

B

backup battery power 7, 9, 18, 22, 23
bass 7
batteries included 8
battery (9V) installation 9
battery (9V) replacement 22, 23
battery (remote control) installation 11
battery (remote control) replacement 11, 23, 24
battery disposal 2, 9, 11, 23

C

cable radio signals 10
cable TV 10
CD player 7, 13, 14
cleaning 23
clock display 17
clock functions 16, 17
clock mode 17, 18, 19
Clock Set 10, 17, 18, 20
connections 10, 13
control panel 16, 19, 21, 22
customer service 8, 12, 23, 24

D

dimensions 23
display brightness 18

E

electrical noise 4, 24
external antenna 10

F

features 7
fluorescent lights 24
FM 15, 16, 19, 20
FM antenna 10, 24
FM reception 24

H

heat from radio 2, 8

I

infrared remote control 7, 15
installing your radio 7
interference 4, 24

L

lithium battery 8, 12
location 8, 24

M

moisture 2, 3, 8
mounting strip 8, 12
Mute 15, 19, 24

O

On/Off 15, 16, 18, 19, 22

P

power connector 10
power cord 8, 10, 24
power loss 9, 22
power rating 23
powered speakers 13, 14
PRESET 20
presets 19, 20, 21

R

radio alarm 15, 16
radio alarm volume 22
radio display 20
radio mode 18
radio reception 10
remote control 8, 11, 12, 15, 19, 21, 22, 24

S

safety information 2, 3, 4
SEEK 20
seek a station 19
serial number 8
signal splitter 10
SLEEP 17
Sleep 15, 22
Sleep/Snooze 16, 21, 22
station frequency 20
station presets 15, 16, 19, 20
STEREO 20

T

tape player 7, 13, 14
television 14, 24
Time 15, 21
time, AM or PM 17
time, AM/PM (12 hour) 18
time, military (24 hour) 18
tone alarm 15, 16
tone alarm volume 22
troubleshooting 24
Tuning 15, 16, 17, 19, 21

U

unmute 15, 19, 24
unpacking 8

V

VARIABLE OUT jacks 14
VOL 20
Volume 15, 16, 19

W

wakeup time 15, 16, 17
warranty card 8, 24
weight 23



Bose® Corporation Sales and Service

USA & Canada Sales

Bose Corporation, The Mountain
Framingham, MA 01701-9168
1-800-637-8781

USA & Canada Service

Bose Corporation, The Mountain
Framingham, MA 01701-9168
1-800-637-8781 or
508-879-7330, x63055

European Office

Bose Products B.V., Nijverheidstraat 8
1135 GE Edam, Nederland
TEL 0299-390111 FAX 0299-390114

Australia

Bose Pty Limited, 1 Sorrell Street
Parramatta NSW, 2150
TEL 02 9204-6111 FAX 02 9204-6122

Deutschland

Postfach 1468
48504 Nordhorn
TEL 0130-2673555 FAX 05921-724250

France

6, Rue Saint Vincent
78100 Saint Germain en Laye
TEL 01-3061 6363 FAX 01-3061 4105

Nederland

Bose B.V., Nijverheidstraat 8
1135 GE Edam, Nederland
TEL 0299-390111 FAX 0299-390114

United Kingdom

Freepost EX 151
Exeter EX1 1ZY
TEL 0800 614 293 FAX 0870 240 2013

World Wide Web

www.bose.com

BOSE[®]
Better sound through research[®]

©2001 Bose Corporation
The Mountain, Framingham, MA 01701-9168 USA
255380 AM Rev.01 JN10846