

KENWOOD

GRAPHIC EQUALIZER WITH AMPLIFIER

KGC-4032

INSTRUCTION MANUAL

KENWOOD CORPORATION

Take the time to read through this instruction manual. Familiarity with installation and operation procedures will help you obtain the best performance from your new graphic equalizer.

For your records

Record the serial number, found on the back of the unit, in the spaces designated on the warranty card, and in the space provided below. Refer to the model and serial numbers whenever you call upon your KENWOOD dealer for information or service on this product.

Model KGC-4032 Serial number _____

WARNING

TO PREVENT ELECTRIC SHOCK,
FIRE AND OTHER INJURY.
PLEASE NOTE THE FOLLOW-
INGS:

- The unit is designed to be connected 12 V DC and negative grounding.

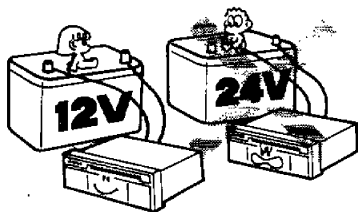

- Do not place the unit, where it will be exposed to direct sunlight or close to heating device.

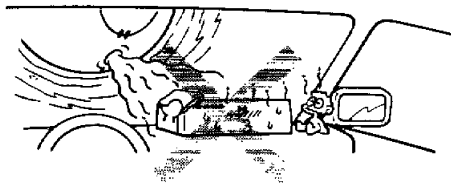

- Do not open enclosure, such as front panel, top or bottom cover.

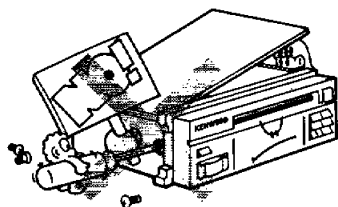

- Do not dash water on the unit.

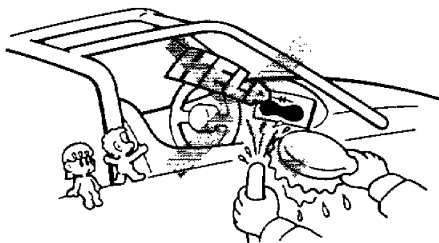

- Do not drop pieces of metal, needles, coins and other electrically conductive materials into the unit.

- Do not place the unit in areas of excessive dust, high humidity or on unstable surfaces.

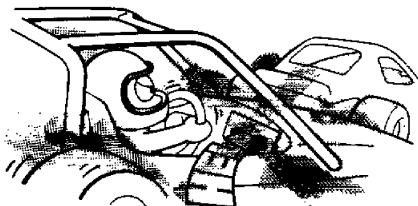
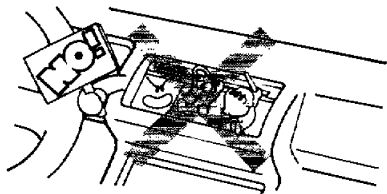

CLEANING

1. Turn the power off, before cleaning the unit.
2. Do not use any type of abrasive pad, thinner, benzine and any such kind of objects.
3. Wipe the front panel and other exterior surfaces of the unit with a soft dry cloth or a soft cloth lightly moistened with a neutral detergent.

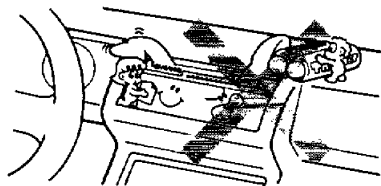

- If an abnormal smell or smoke is detected, immediately turn the power off.



- If you have difficulty in installing the set in your car, please contact your KENWOOD dealer.

CONTENTS

	Page
● EQUALIZER CURVE ADJUSTMENT	5
● LEVEL METER.....	6
● FADER ADJUSTMENT	7
● ACCESSORY AND INSTALL MANNER	8
● INSTALLATION	9
● CONNECTION	10
● TROUBLESHOOTING GUIDE	11
● SPECIFICATIONS	12

EQUALIZER CURVE ADJUSTMENT

1

Press the Graphic equalizer switch to ON.

NOTE: Graphic equalizer switch to OFF, a flat frequency response is obtained.

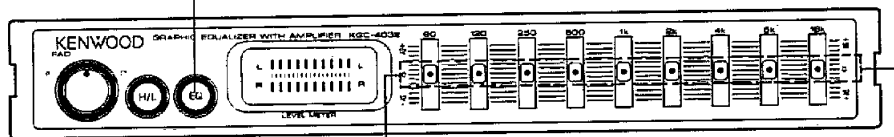

■ TO INCREASE THE LEVEL OF THE SELECTED BAND

2

Move the Graphic equalizer knob of the band you wish to adjust in the upward direction.
(The level of the frequency band corresponding to the moved knob increases.)

MAX. : +12dB



■ TO DECREASE THE LEVEL OF THE SELECTED BAND

2

Move the Graphic equalizer knob of the band you wish to adjust in the downward direction.
(The level of the frequency band corresponding to the moved knob decreases.)

MAX. : -12dB

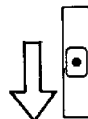

LEVEL METER

The LED lights up according to the output level.

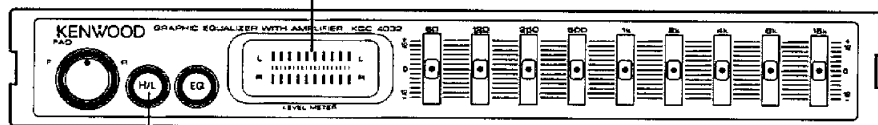

■ Listening in large volume

Whenever the display of the level meter is too large, set the switch to "LOW".

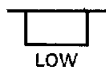

■ Listening in small volume

Whenever the display of the level meter is too small, set the switch to "HIGH".



FADER ADJUSTMENT

- When you wish to emphasize the sound from the front speakers

Rotate the Fader controller to the left.

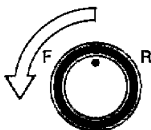

- When you wish to emphasize the sound from the rear speakers



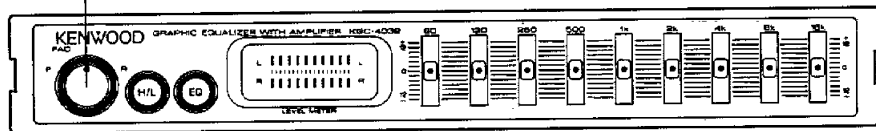
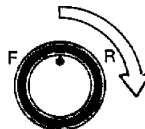





Rotate the Fader controller to the right.

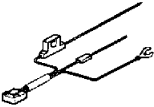

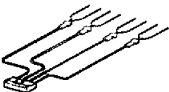
- Only with the 4-speaker system, the Fader operates.
- The preout becomes sound at the rear side.

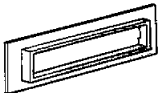
ACCESSORY AND INSTALL MANNER

■ ACCESSORY

No.	Part name	External view	Number of units	No.	Part name	External view	Number of units
①	Power connection cord		1	⑤	Bracket		2
②	Speaker cord		1	⑥	Flat head screw (M4 × 6)		4
③	Panel frame		1	⑦	Washer assemblies screw (M4 × 8)		5
④	Side bracket		2	⑧	Tapping screw (φ4 × 16)		4

■ INSTALL MANNER

1. Before installation and wiring, remove the (-) terminal of the battery to prevent shortcircuiting.
2. Connect the input and output cords of the system.
3. Connect the ground to the metal chassis of the car.
4. Connect the back-up power supply lead (yellow).
5. Install the set and after confirming the installation and wirings are correct, connect the (-) terminal of the battery.



- If a fuse is blown, first check that the associated wires are not short-circuited, then replace the fuse with a new one having the same capacity.

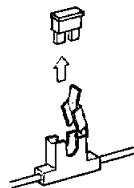
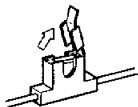

INSTALLATION

- When installing in the car, choose the best position with regard to overall safety of the system and ease of operation.
- As installation fixtures, use only the accessories supplied.

● Installing the unit in the dash panel:

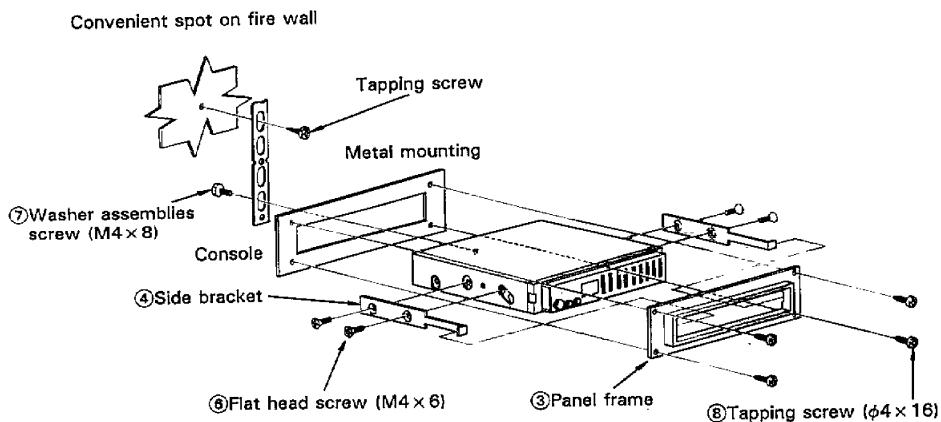

● Installing the unit below the dash board:

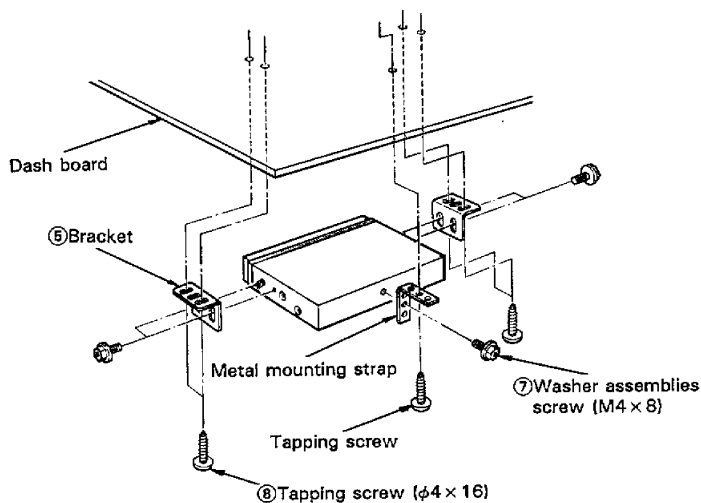

CONNECTION

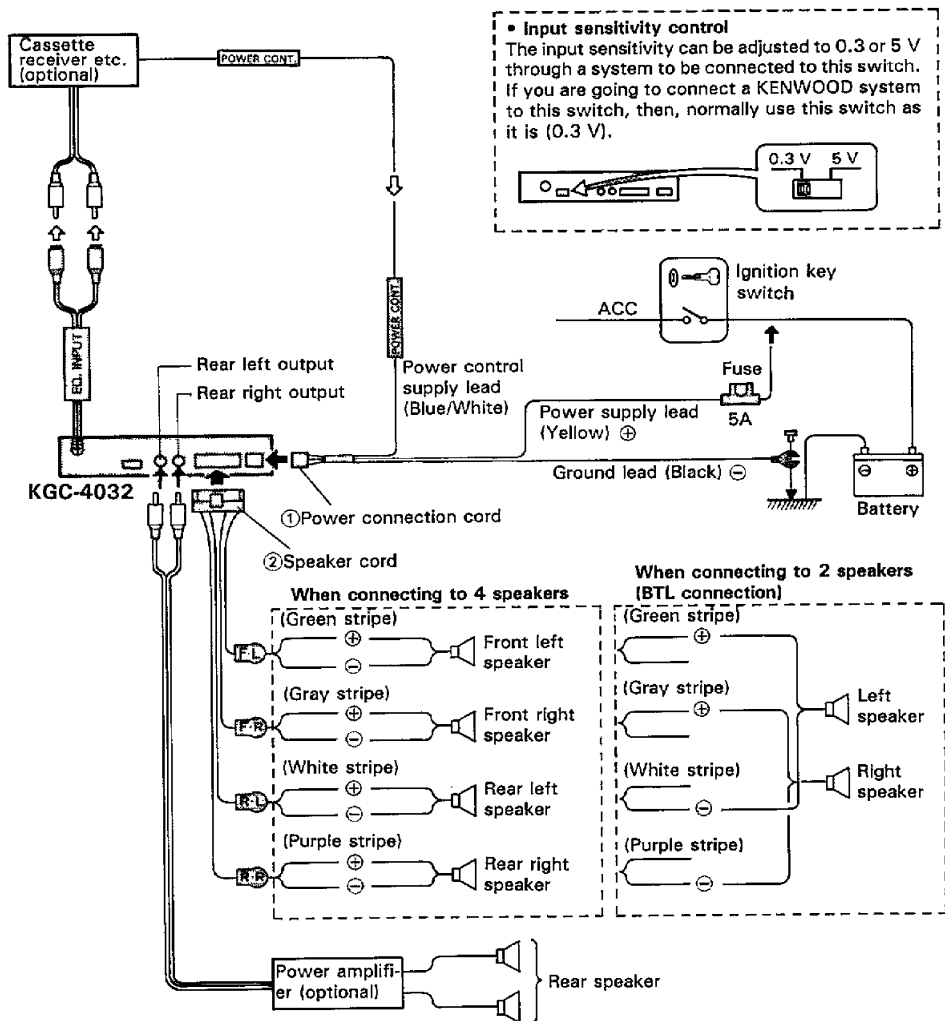

- As the unit uses BTL output, always connect the without stripe speaker wires to the ⊖ terminals of the speaker systems. Never let the ⊖ speaker wires touch and never connect them to the chassis (ground). Do not let the speaker terminals come into contact with the chassis (ground). Insulate any unused output wire to prevent a short circuit.
- Secure unconnected wires properly so that they do not contact the vehicle chassis.

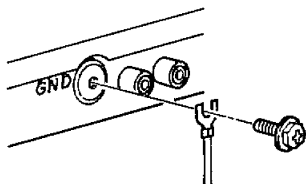

- If the RCA extension cable (optional) is provided with a GND wire, then, fix it into the threaded hole for GND on the rear of the main unit, with the ⑦ washer assembly screw.

TROUBLESHOOTING GUIDE

What often appears to be a malfunction is often due to user error in operation or connection. When trouble occurs with your unit, please check the following before calling for service.

Symptom	Possible cause	Remedy
Power cannot be switched ON.	<ol style="list-style-type: none"> 1. The backup fuse is blown. The fuse of the connected head unit is blown. 2. The equalizer's power connector is not connected to the power supply. 	<ol style="list-style-type: none"> 1. After checking that no cords are short-circuited, replace the blown fuse with a new one of the specified capacity. 2. Connect the power connector.
Sound is not heard from the front or rear speakers.	The Fader controller is turned fully to Front or Rear.	Turn the Fader controller to optimize the front/rear balance.
Sound is not output.	<ol style="list-style-type: none"> 1. The speaker cord, system power, or pre-out connections are not secure. 2. The pre-fader control of the head unit is set to the minimum position. 	<ol style="list-style-type: none"> 1. Connect cords properly according to the instructions in the instruction manual. 2. Set the fader of the head unit to the center position and check if sound is output.

SPECIFICATIONS

Specifications subject to change without notice.

Equalizer section

Equalizer center frequency	60 Hz, 120 Hz, 250 Hz, 500 Hz, 1 kHz, 2 kHz, 4 kHz, 8 kHz, 16 kHz
Equalization range	- 12 ~ + 12 dB

Audio section

Maximum output power	40 W + 40 W
Rated output power (less than 1% THD, 20 Hz - 20 kHz, 4 Ω)	20 W + 20 W
Frequency response (- 3 dB)	15 Hz - 60 kHz
T.H.D. (at 1 kHz)	0.03%
Signal-to-noise ratio	100 dB
Input Sensitivity (rated output)	
Normal	0.3 V
Booster	5.0 V
Input impedance	10 k Ω
Output impedance (preout)	600 Ω

General

Operating voltage	14.4 V (11 - 16 V)
Current consumption (Max.)	5.0 A
Installation size (W x H x D)	178 x 25 x 150 mm (7 x 1 x 5-7/8 in)
Weight	0.7 kg (1.5 lb)