



SUMMARY MANUAL

VDC-HD3500P/HD3500
VDC-HD3300P/HD3300
VDC-HD3100P/HD3100
VCC-HD3500/HD3300

Side B Megapixel Camera

THIS INSTALLATION SHOULD BE MADE BY A QUALIFIED SERVICE PERSON AND SHOULD CONFORM TO ALL LOCAL CODES.



Please read this instruction manual carefully in order to ensure correct installation. In addition, be sure to read carefully the electronic manual (INSTRUCTION MANUAL) contained in the supplied CD-ROM to ensure correct operation of the camera.

English

Français

Español

Deutsch

中文简体

日本語

Table of Contents

Name and Function of Each Component	2
Lens Adjustment.....	3
Network Settings	5
Specifications	7
Copyright Notice	9

■ Accessories

- ① Video Cable
- ② Cushioning Sheet
- ③ Hexagonal Wrench
- ④ Pattern Sheet
- ⑤ CD-ROM

⑥ Connector

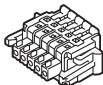

⑦ Clamping Core

To prevent electromagnetic interference



VDC-HD3500P

■ Check your operating environment.

To operate the camera via network operation, you must meet the following operating requirements.

- **PC** : IBM PC/AT compatible
- **Operating system** : Windows XP Professional/Windows Vista
- **CPU** : Core2Duo E6700 2.66 GHz or higher
- **Memory** : Windows XP: 1GB or more
Windows Vista: 2GB or more
- **Network interface** : 10Base-T/100Base-TX (RJ-45 connector)
- **Display card** : 1920×1200 pixels or higher
- **Graphics chip** : ATI RADEON HD2600 series or higher
nVIDIA GeForce 8600 series or higher
nVIDIA Quadro FX550 series or higher
- **Web browser** : Internet Explorer Ver. 6.0 SP2 or higher,
or Internet Explorer Ver. 7.0

■ You can automatically set up the IP address of the camera.

This software application is useful when two or more cameras are connected to the network.

Download "AUTO IP SETUP" software application from the supplied CD-ROM.

Name and Function of Each Component

■ Top Face

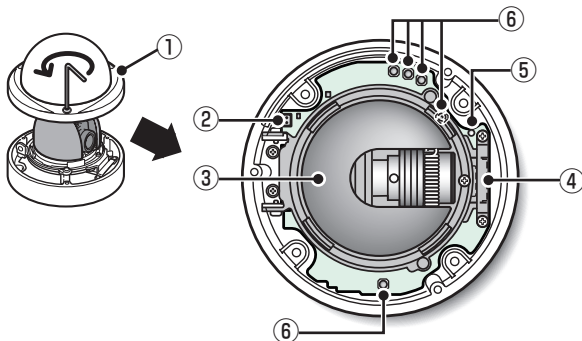

- ① Dome cover
- ② Monitor Output Socket
- ③ Inner cover
- ④ SD Card Slot (VDC-HD3500P/HD3500)
- ⑤ LED lamp (VDC-HD3500P/HD3500)

The power indicator blinks to indicate the following camera statuses.

- Recording to SD memory card stopped
- Firmware update in progress
- An SD memory card error occurred (Fast blink)

⑥ Operation Buttons

- **Restarting camera: Press the RESET button.**
☞ OPTION SETTINGS (CAMERA REBOOT)
- **Restoring factory default settings: Press the NEAR and SET buttons simultaneously.**
☞ OPTION SETTINGS (FACTORY DEFAULT)
- **Resetting login password (for default users only): Press the FAR and SET buttons simultaneously.**
- **Adjusting focus/Adjusting iris**
☞ Page 3, "Lens Adjustment" section or the CAMERA SETTINGS (FOCUS ASSIST/IRIS SETTING) section on the electronic manual.
- **Inverting video of wall-mounted camera: Press the REVERSE button.**
- **Viewing Firmware Version:**
☞ "Viewing Firmware Version" section or the OPTION SETTINGS (FIRMWARE UPDATE) section on the electronic manual.

Lens Adjustment

Focus can be electrically adjusted. For high-resolution megapixel images, the focus assist function is useful to obtain a precise focus because otherwise it is extremely difficult.

-  **The focus must be readjusted if the camera has lost focus due to difference in the subject distance or ambient temperature, the deterioration of the lens and installation environment, and the like that have been caused over the years.**

- 1** Press the SET button for 2 seconds or more.
The monitor now shows the SELECT MENU screen.

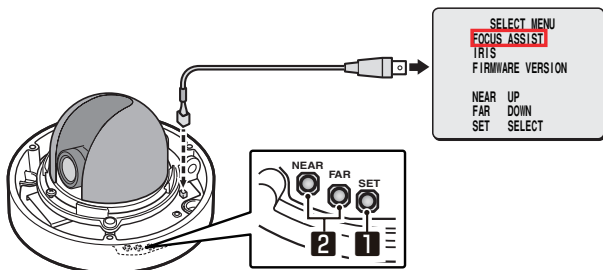

-  **On the SELECT MENU screen, all information is displayed in English.**

- 2** Select [FOCUS ASSIST] using the NEAR/FAR button and press the SET button.
The monitor now shows the focus adjustment screen.

- 3** Adjust the lens orientation, and adjust the angle of view with the zoom ring and the focus with the operation buttons.

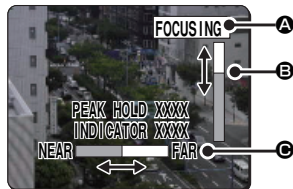

-  **PEAK HOLD:** Shows the value of the maximum focus level.
INDICATOR: Shows the value of the current focus level.

■ Adjusting focus

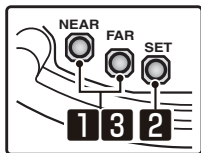

1 Roughly focus the subject using NEAR/FAR buttons.

Make adjustment while watching the monitor.

2 Press the SET button.

The camera automatically focuses on the subject. Note that the color of the status indicator **A** “**FOCUSING**” turns from black to orange.

The status indicator **A** changes to “**ERROR**” when the subject cannot automatically come into focus.

In this case, manually adjust the focus. (📖 Electronic manual)

3 Press the NEAR/FAR button to adjust the focus.

Make adjustment so that the FA bar gauge **B** indicates the highest level.

When the subject comes into focus, the color of the status indicator **A** “**FOCUSING**” changes from black to orange.



Pressing the buttons moves the FB bar gauge **C**.

The position changes step by step each time the button is pressed and continuously at a high speed when the button is held down.

4 Press the SET button for 2 seconds or more.

The focus adjustment screen will close.



- The focus adjustment screen will also close automatically if left idle for 5 minutes or more.

- VDC-HD3500P/HD3500/HD3300P/HD3300:

If video is out of focus in either color or black-and-white mode, adjust the focus in respective modes.

Network Settings

Preparing Your Computer for Network Operation

- 1 Check your operating environment.** ( Page 1)
- 2 Connect the camera to the network to which your PC is also connected.**
- 3 Configure the network information on your PC.**
Configure information such as the IP address of your PC.
- 4 Install the “H.264 Plug-in” from the supplied CD-ROM onto your PC.**
You are now ready to monitor the surveillance video in the H.264 format.
- 5 Start Internet Explorer.**
The supported Web browser is Internet Explorer Ver.6.0 SP2 or higher, or Internet Explorer Ver.7.0.
- 6 Access the camera from your Web browser.**
From your Web browser (Internet Explorer), access the camera and log into the system as an “admin” user (administrator).
- 7 In the address bar, type the IP address of the camera and press [Enter] key.**
When you access the camera, the login screen appears.
If this is the first access to the camera, in the Address bar, enter the default IP address as follows.



Address



If you set [SSL] to “ON”, before the IP address, type “https://” (instead of “http://”).

Attempts to access the camera using the default IP address will fail if that address is already being used by another device in the network. If so, change the IP address of the existing device before accessing the camera.

- 8** Type your user name and password and click [OK].
The language selection screen appears.



If this is the first access to the camera, log in as an admin user (administrator) using the following default authentication information.

- **User name: admin**
- **Password: admin**

- 9** Click the button corresponding to the language you want to use.

The live screen appears.

From the second login onwards, the live screen appears automatically by skipping the language selection screen.

If this is the first access to the camera, configure the system clock on the CLOCK SETTINGS screen.

Specifications

■ Camera

Image pickup device	1/3" CMOS sensor
Effective pixels	16:9 1920 (H)×1080 (V), 4:3 2288 (H)×1712 (V)
Lowest image illumination	50IRE: 1.0 lx (at F1.2, color mode, high gain) 50IRE: 0.1 lx (at F1.2, black-and-white mode, high gain)
Video S/N ratio	50dB (when AGC is "OFF")
Lens	Built-in vari-focal lens f=3 to 9 mm, F1.2 to 2.1
Focus adjustment	Focus assist function
Iris control	DC iris lens supported
Digital PTZ (VDC-HD3500P/HD3500)	Enables electronic pan, tilt, and zoom operations on clipped subject areas in VGA size. Zoom magnification: max. 2X
Mirror	H/V/HV/OFF
Privacy mask	On/Off, max. 8 mask patterns
Motion sensor	On (Motion masking/motion detection area setting, or video analytics)/Off, face detection function supported
Language selection	English, French, German, Spanish, Japanese

For further details on the specifications of the camera, refer to the electronic manual.

■ SD Recording (SD Memory Card) (VDC-HD3500P/HD3500)

Recording mode	Alarm recording, backup recording in event of a network failure
----------------	---

For the recommended SD memory cards, visit our website.

<http://www.sanyo-cctv.net/>

■ I/O

Video output	Composite output
LAN	10BASE-T/100BASE-TX (RJ-45 connector)
Card slot (VDC-HD3500P/HD3500)	1 (SDHC compliant, max. 32 GB supported)
Alarm input	2 (NO/NC), also serving as Day/Night switching terminal
Alarm output	2 (NO/NC, 16V, 150 mA, open collector)
Audio input/output (VDC-HD3500P/HD3500)	Microphone input (3.5-mm mini jack) Line output (3.5-mm mini jack)

■ Network

Image/video compression	H.264/JPEG
Video size (H.264)	(16:9) 1920×1080, 1280×720, 640×360, 320×180 (4:3) 1600×1200, 1280×960, 1024×768, 640×480, 320×240
Video size (JPEG)	(16:9) 1920×1080, 1280×720, 1024×576, 640×360 (4:3) 2288×1712, 1600×1200, 1280×960, 1024×768, 800×600, 640×480, 320×240
Picture quality	QUALITY mode: BASIC, NORMAL, ENHANCED, FINE, SUPER FINE BITRATE mode: User-specified bit rate
Interface	10BASE-T/100BASE-TX
Protocol	TCP/IP, UDP, HTTP, HTTPS, SMTP, NTP, DHCP, FTP, DDNS, RTP, RTSP, RTCP
Audio	G.711 (Bidirectional)
Simultaneous access	20
Security	BASIC authentication (ID/password), SSL, IP filtering

■ Others

Waterproof standard	IP66
Operating ambient temperature/humidity	-10 to +50°C/14 to 122°F, 90% RH or less (no condensation)
Power source	12 to 15 V DC/24 V AC ± 10%, 50/60 Hz, PoE
Power consumption	6.8W (with heater turned on: 20 W) (VDC-HD3500P/ HD3500) 4.6W (with heater turned on: 18 W) (VDC-HD3300P/ HD3300, VDC-HD3100P/HD3100)
Dimensions	φ146 × 94 mm/φ5.7 × 3.7 inch Dome diameter: 114 mm/4.5 inch
Weight	800 g/28.2 oz. (VDC-HD3500P/HD3500) 700 g/24.7 oz. (VDC-HD3300P/HD3300, VDC-HD3100P/ HD3100)

Appearance and specifications are subject to change without prior notice or obligations.

■ Approvals: IP66

This unit has been certified to IP66 standards when properly installed.

Ensure all openings in enclosure are sealed as per manufacturer's instructions.

Copyright Notice

The instruction manual and the software are copyrighted by SANYO Electric Co., Ltd. No materials contained in the manual and the software may, wholly or partially, be copied, modified, reproduced, or distributed in any format without the prior permission of the copyright holder.

Microsoft, Windows, ActiveX and Internet Explorer are registered trademarks or trademarks of Microsoft Corporation in the United States and other countries. The official name for “Windows” used in this manual is Microsoft® Windows® Operating System.

In this manual, note that the word “Windows” refers to both “Microsoft® Windows® XP Operating System” and “Microsoft® Windows® Vista Operating System”.

Intel and Pentium are registered trademarks or trademarks of Intel Corporation and its subsidiaries in the United States and other countries.

IBM and IBM PC/AT are trademarks of International Business Machines Corporation. All other brands and product names in this manual are the registered trademarks or trademarks of their respective owners.

SDHC Logo is a trademark.



■ Notes on data storage

- It is recommended that important data be copied to a separate medium.
- In the following situations, it is possible that recorded data may be lost (destroyed). Our company bears absolutely no responsibility for damages or profits loss due to the loss of data.
 - The medium (SD card or external hard disk) is not used correctly.
 - The medium is not installed on the device correctly.
 - The medium is subjected to electrical or mechanical shock.
 - The card is removed or the power is turned off while the card is being accessed.
 - The medium has reached the end of its service life.

■ License for Software Contained in CD-ROM

- Please read carefully the terms and conditions contained in the license agreement that appears on the screen during the software installation process. Provided that you have agreed to all the terms and conditions therein, you may use the software subject to the license agreement.
- For information on the other products or services provided by third parties which are introduced in the CD-ROM, please contact each supplier or manufacturer.