

Microcassette™ Dictator/Transcriber

M-2020

Operating Instructions

Before operating the unit, please read this manual thoroughly, and retain it for future reference.

Owner's Record

The model and serial numbers are located at the bottom.
Record the serial number in the space provided below.
Refer to these numbers whenever you call upon your Sony dealer regarding this product.

Model No. M-2020 Serial No. _____

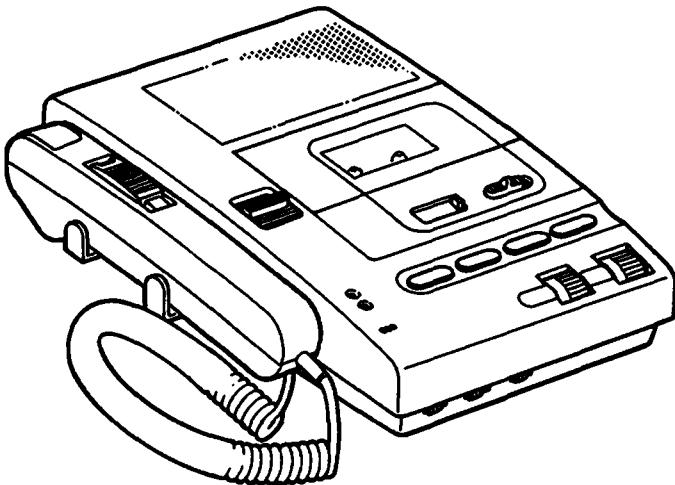

To prevent fire or shock hazard, do not expose the unit to rain or moisture.

To avoid electrical shock, do not open the cabinet. Refer servicing to qualified personnel only.

INFORMATION

This equipment has been tested and found to comply with the limits for a Class B digital device, pursuant to Part 15 of the FCC Rules. These limits are designed to provide reasonable protection against harmful interference in a residential installation. This equipment generates, uses, and can radiate radio frequency energy and, if not installed and used in accordance with the instructions, may cause harmful interference to radio communications. However, there is no guarantee that interference will not occur in a particular installation. If this equipment does cause harmful interference to radio or television reception, which can be determined by turning the equipment off and on, the user is encouraged to try to correct the interference by one or more of the following measures:

- Reorient or relocate the receiving antenna.
- Increase the separation between the equipment and receiver.
- Connect the equipment into an outlet on a circuit different from that to which the receiver is connected.
- Consult the dealer or an experienced radio/TV technician for help.

This device complies with Part 15 of the FCC Rules.

Operation is subject to the following two conditions:

(1) This device may not cause harmful interference, and (2) this device must accept any interference received, including interference that may cause undesired operation.

You are cautioned that any changes or modifications not expressly approved in this manual could void your authority to operate this equipment.

Table of Contents

Features	3
Precautions	4
Notes on cassettes	5
Location and function of controls	6
Preparation	8
Power connection	8
Connecting the hand control unit	8
Connecting the foot control unit	9
Cassette insertion	9
Dictation	10
Transcription	12
Recording	13
Telephone Pick-up	13
Alarm system	14
Maintenance	14
Specifications	15
Troubleshooting guide	16

Features

- The supplied hand control unit remotely controls the M-2020 dictator/transcriber.
- Auto backspace function makes transcribing easy by reviewing the last few recorded words each time listening is resumed. (Only with the foot control unit.)
- Adjustable tape speed and tone control.
- Two alarms (end-of-tape, no-cassette) alert you.
- The supplied foot control unit makes Play/Stop/Rew possible with your foot. Convenient for transcribing with your hands free.

- Operate the unit only on 9 V DC.
- Use the supplied AC power adaptor. Do not use any other AC power adaptor as it may cause malfunction.
- Unplug the unit from the wall outlet when it is not to be used for an extended period of time. To disconnect the cord, pull it out by grasping the plug. Never pull it by the cord.
- Use only the **MICROCASSETTE**™ with this unit.
- Two tape speeds can be selected for recording with the SPEED selector: 2.4 cm/sec. or 1.2 cm/sec. Match the playback speed to the recording speed.
- Do not install the unit in a location near heat sources such as radiators or airducts, or in a place subject to direct sunlight, excessive dust, mechanical vibration, or shock.
- Allow adequate air circulation to prevent internal heat build-up. Do not place the unit near materials (curtains, draperies) that may block the ventilation holes.
- Should any solid object or liquid fall into the unit, unplug the unit and have it checked by qualified personnel before operating it any further.
- The AC power adaptor which has been supplied becomes hot if it is connected to an AC outlet for a long period of time. But this will not cause any trouble.

If you have any question or problem concerning your unit that is not covered in this manual, please consult the Sony dealer from whom you purchased the unit.

Notes on Cassettes

Slack in the tape

Before inserting, take up any slack in the tape by using a pencil.

To prevent accidental erasure

When a recording is made, the previous recording is automatically erased. To prevent erasure, break the cassette tabs.

To record on a cassette with removed tabs

Cover each slot with a piece of plastic tape.

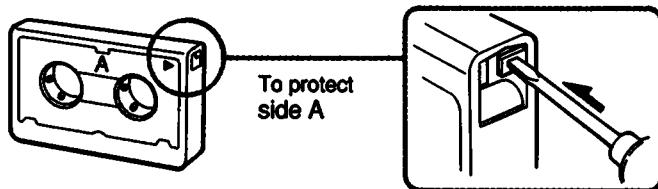

Note on the Microcassette

This unit uses only modern standard Microcassettes. The non-standard Microcassettes cannot be used because their "L" dimension shown in the illustration below is different.

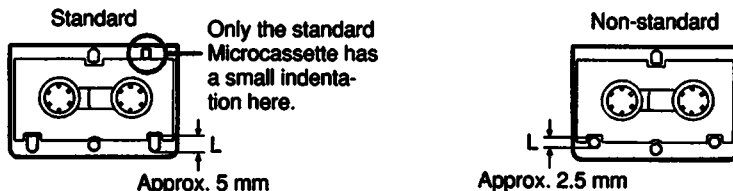

Location and Function of Controls

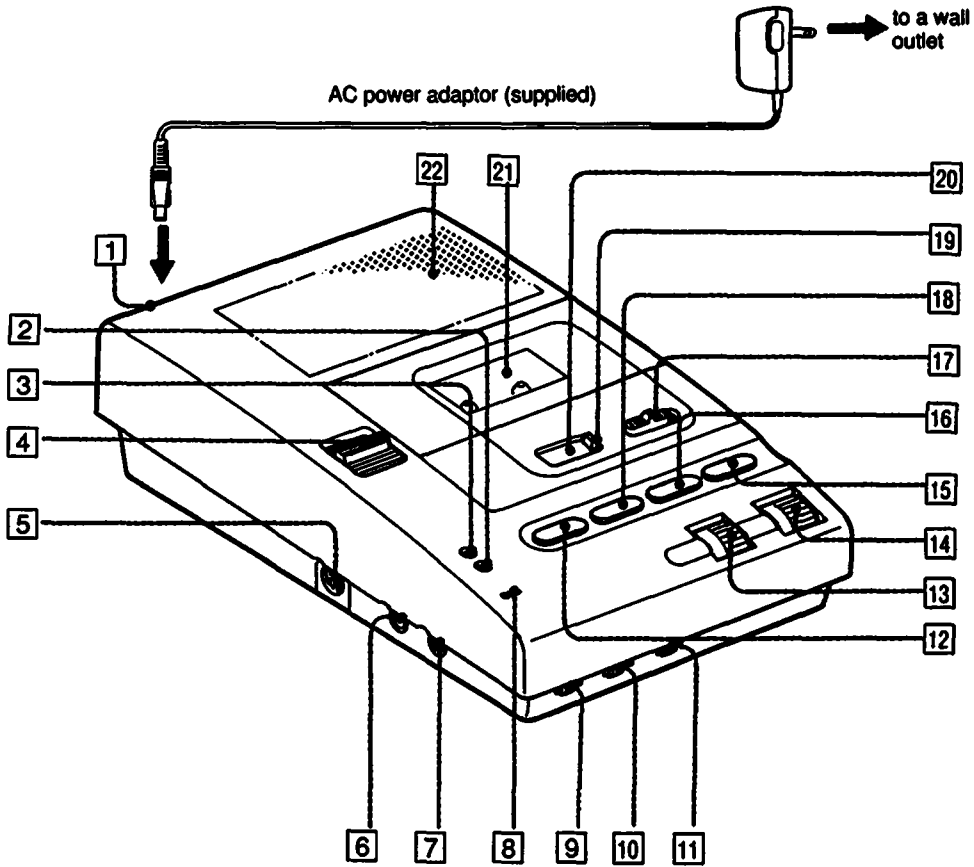

Hand control unit (supplied)

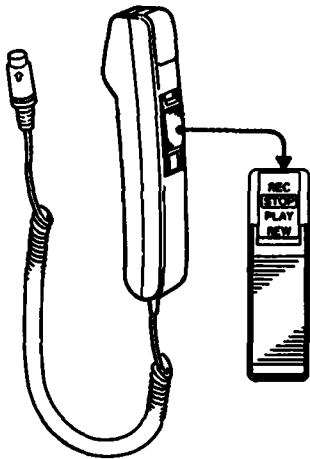

Foot control unit (supplied)

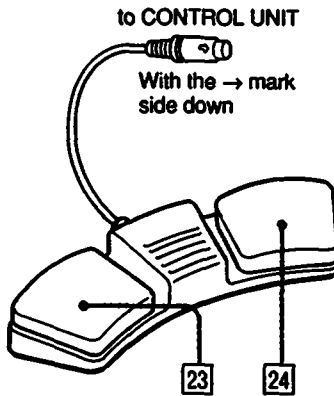

Cradle (supplied)

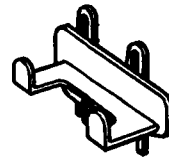

- 1** DC IN 9 V jack (external power input) jack
- 2** OPR (operation) indicator
The indicator illuminates during tape operation.
- 3** REC (record) indicator
The indicator illuminates during recording.
- 4** ▲ EJECT (cassette eject) lever
- 5** CONTROL UNIT connector
- 6** MIC (external microphone) (PLUG IN POWER)
- 7** EARPHONE jack (minijack)
- 8** MIC (built-in microphone)
- 9** SPEED selector
2.4 cm: A 60-minute recording can be made using both sides of the MC-60 Microcassette.
This setting produces optimum sound and is recommended for normal use.
1.2 cm: A 120-minute recording can be made using both sides of the MC-60.
- 10** REV (reverse) TIME (0/1/3)
(auto-backspace time) control
- 11** TONE control
Slide toward H (high) to reinforce treble, and L (low) to weaken it.
- 12** ◀◀ REW (rewind) button
- 13** SPEED CONTROL (tape speed control)
- 14** VOLUME control
- 15** ▶▶ FF (fast forward) button
- 16** ▶ PLAY button
- 17** Recording (STOP/REC) switch
- 18** ■ STOP button
- 19** RESET button
Press to reset the counter to zero.
- 20** Tape counter
- 21** Cassette compartment
- 22** Built-in speaker
- 23** Rewind pedal
- 24** Playback pedal

Power Connection

Note on the AC power adaptor
Use only the AC power adaptor supplied. Do not use any other AC power adaptor.

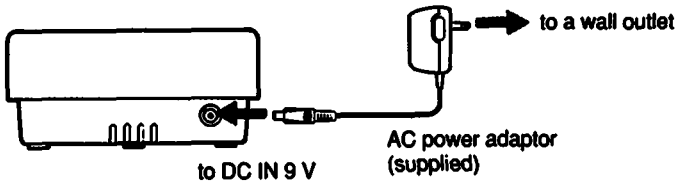

Polarity of the plug

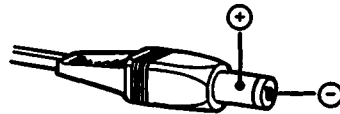

Connecting the Hand Control Unit (supplied)

Be careful of the direction of the plug when connecting it to the unit.

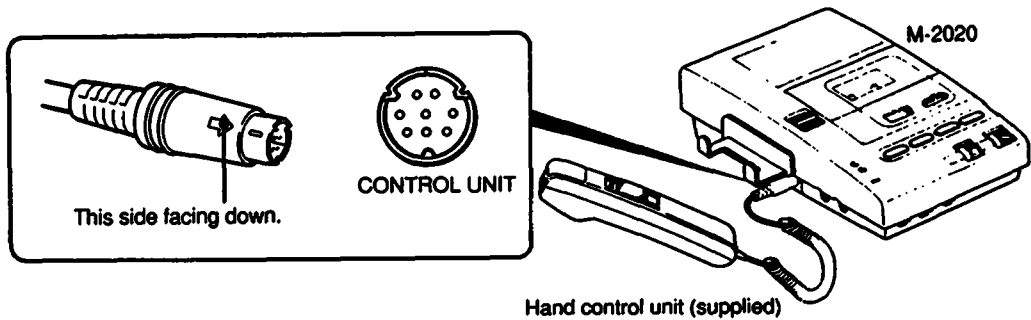

Attaching the cradle

Attach the supplied cradle to the left side of the unit. Insert the cradle into the slots until there is a click sound to secure it. Place the hand control unit (supplied) on the cradle while not in use.

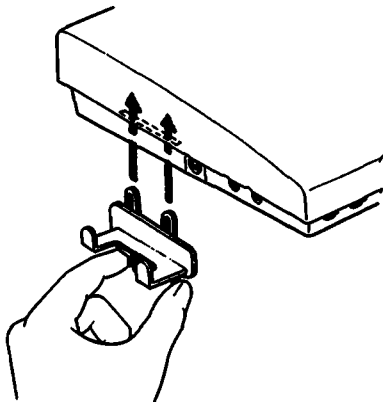

Attaching the cradle

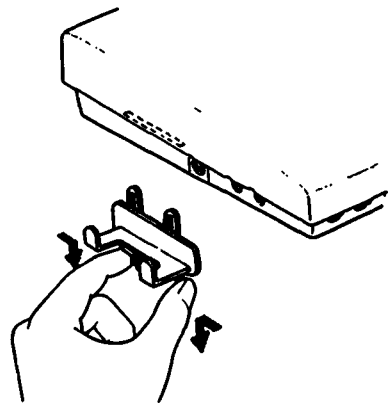

Disconnecting the cradle

Connecting the Foot Control Unit (supplied)

Be careful of the direction of the plug when connecting it to the unit.

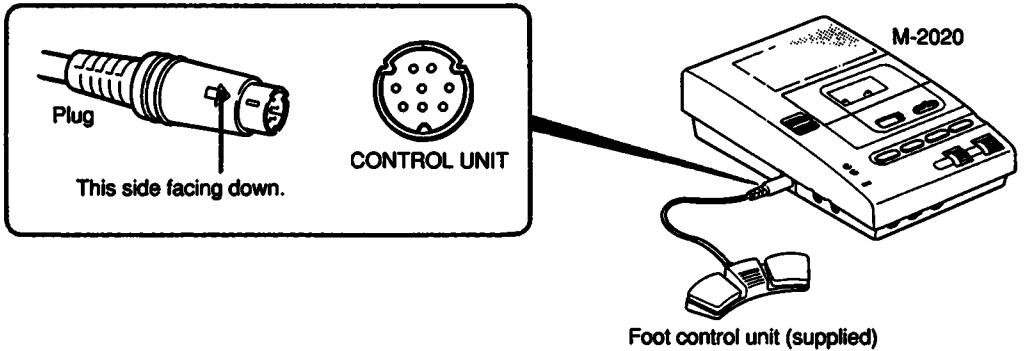

Cassette Insertion

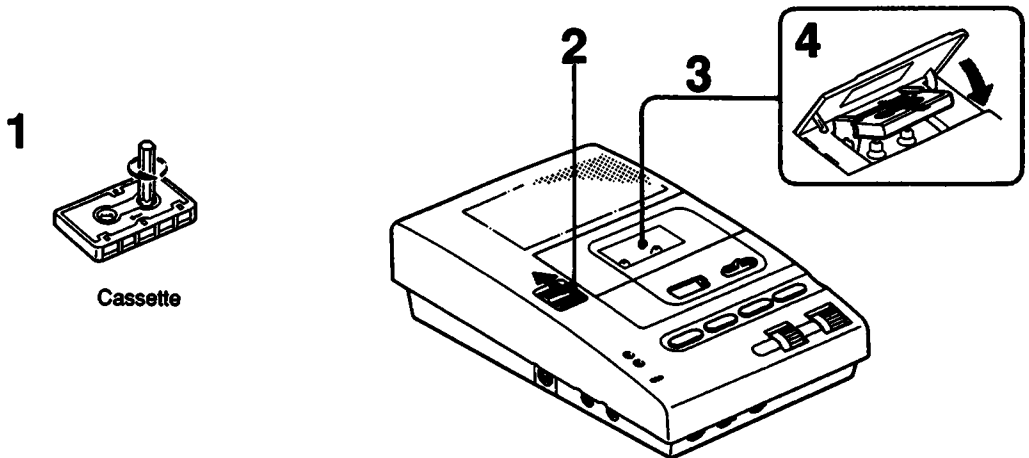

- 1** Take up any slack in the tape.
- 2** Slide the eject button in the direction of the arrow to open the cassette holder.
- 3** Insert a cassette into the cassette holder with the side to be recorded on or played back facing upward.
- 4** Close the cassette holder.

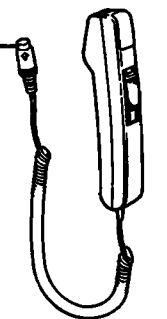
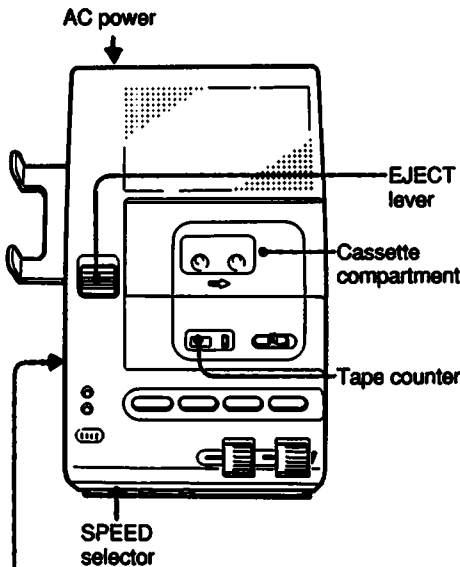

Hand control unit (supplied)

Connect the AC power adaptor to the unit and to an AC outlet.



Connect the supplied hand control unit.



Slide EJECT and insert a cassette.



If the tape counter is not reset to zero, press RESET.

Select the tape speed with the SPEED selector.



Set the function selector of the hand control unit (supplied) to REC and speak into the microphone.



For quick review/ playback and correcting the dictated material, keep the function selector pressed down toward REW to rewind the tape until the desired point on the tape is reached. Release the selector and playback of the dictation begins. When the reviewing is completed, set the function selector to REC to proceed with dictation.

Set the function selector of the hand control unit (supplied) to STOP.



Slide the eject button to remove the cassette.



Hand the cassette to your secretary or transcriptionist.

For transcribing, refer to Transcription on page 12.

Tape transport operation

	M-2020	Hand control unit (supplied)	Foot control unit (supplied)
Rewind	Press ◀◀ REW.	Keep the function selector pressed down toward REW.	Keep the left side of the pedal depressed.
Stop	Press ■ STOP.	Set the function selector to STOP.	Release the pedal.
Play	Press ▶▶ PLAY.	Set the function selector to PLAY.	Keep the right side of the pedal depressed.
Fast forward	Press ▶▶▶ FF.		

When the tape reaches its end or beginning, the unit automatically shuts off.

Tips for More Efficient Dictation

Before you start dictation

- Organize your thoughts.
- Make notes or an outline of what you want to dictate.
- Check that the cassette is erased.

When you dictate

- Identify yourself. (Name, department, phone number)
- Indicate the type of dictation. (Memo, letter, etc.)
- Give transcribing instructions. (Type of stationery, number of copies and who they are for, envelopes, etc.)
- Specify distribution (Names, addresses, etc.)

During dictation

- Relax and speak clearly, at normal speed.
- Short sentences are best.
- Include punctuations.
- Spell out difficult or unusual words.
- Correct your mistakes. (Review and redictate.)

Transcription

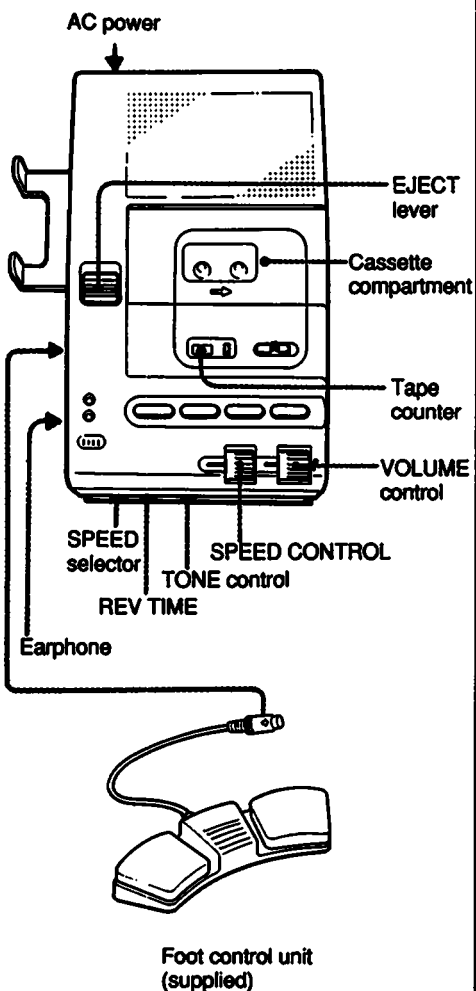

Disconnect the hand control unit.

Connect the supplied foot control unit.

Slide EJECT and insert a cassette.

Connect the earphone if necessary.

Set SPEED selector to the same speed used for dictation.

Step on the right side of the pedal to PLAY.

Adjust VOLUME and TONE.

After transcribing, stop the tape.
Release the pedal.

Use of foot control unit

The foot control unit leaves your hands free, enabling you to control this transcriber with your foot.

Auto backspace

The tape rewinds a little each time it is stopped and the last few recorded words can be reviewed when you resume listening. Adjust REV (reverse) TIME to the desired length (position 1, about 1 second; position 3, about 3 seconds). At position 0, the tape stops without rewinding at all. This functions only when the foot control unit (supplied) is used.

Speed control

The tape speed is adjustable with the SPEED CONTROL. The tape runs at normal speed with the control set to the center click position.

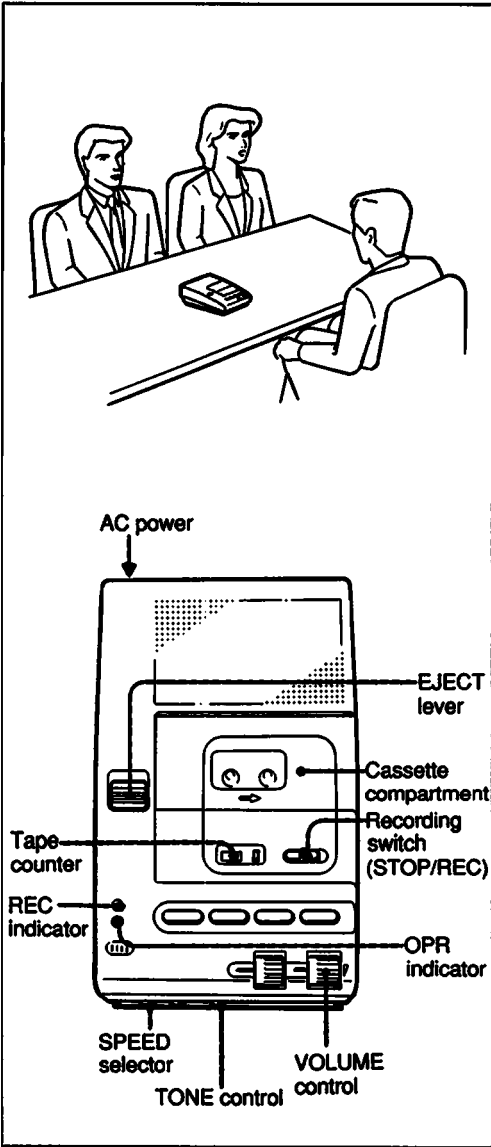

Connect the AC power adaptor to the unit and to an AC outlet.



Slide EJECT and insert a cassette.



Select the tape speed with the SPEED selector.

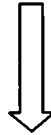

If the tape counter is not reset to zero, press RESET.

Slide the recording switch to REC and start recording. The REC indicator and OPR indicator illuminate during recording. No recording level adjustment is necessary.



To stop the tape, slide the recording switch to STOP.

When monitoring the recording

The recording can be monitored through the earphones (supplied). Adjust VOLUME if necessary.

What to be recorded

Conference or interview: Use the built-in microphone or an optional Sony microphone.

For better recording

Sony microphone, ECM-F01 or ECM-K7 are recommended.

Telephone Pick-up

To record telephone conversation, connect the optional telephone pick-up to the MIC jack. For further details, refer to the instruction manual of the telephone pick-up.

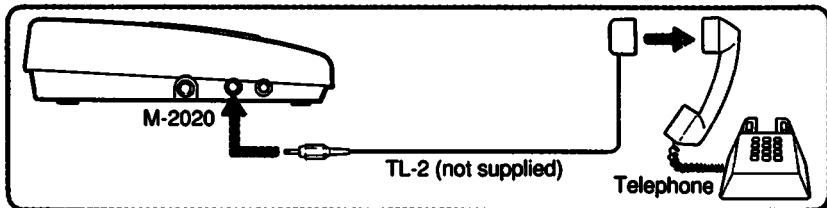

* The telephone pick-up cannot be used on some telephones.

Alarm System

An alarm sounds in the following situations

Unit	Function	Situation and indicator	
		No cassette, or the cassette tabs have been removed.	The end/beginning of the tape.
Main unit	REW		●
	PLAY		●
	FF		●
	REC	●	●
Foot control	PLAY		●
	REW		●
Hand unit	REC	●	●
	PLAY		●
	REW		●

To Stop the Alarm Sound

When using the main unit:

The alarm stops automatically at the end or beginning of the tape. However, when recording, slide the recording switch to STOP to stop the alarm.

When using the foot control unit:

Release it to stop the alarm.

When using the hand unit:

Slide the function selector to STOP. The alarm will stop.

Maintenance

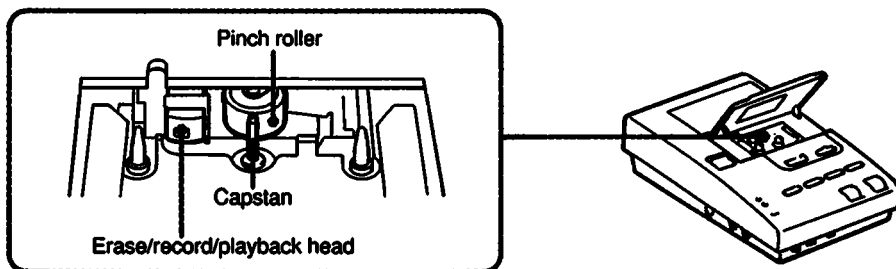

Cleaning the head

To produce optimum sound, keep the tape head clean.

Moisten a cotton swab or a soft cloth with alcohol, and wipe the parts shown above.

Cleaning the cabinet

Clean the cabinet with a soft cloth slightly moistened with a mild detergent solution. Never use strong solvents, such as thinner or benzene, since they may damage the finish.

Tape	MICROCASSETTE™ (normal position type)	Power consumption	600 mA
Track system	2-track 1-channel monaural	Dimensions	Approx. 133×61.5×230 mm (w/h/d) (5¼×2½×9¼ inches) not incl. projecting parts and controls
Tape speed	2.4 cm/sec. (15/16 ips), 1.2 cm/sec. (15/32 ips)	Weight	Approx. 0.8 kg (1 lb 2 oz)
Tape speed control	-10 % to +50 %	Supplied accessories	Earphone (1) Foot control unit (1) AC power adaptor (1) Hand control unit (1) Cradle (1)
Auto back space	Approx. 0/1/3 sec.		
Frequency response	250–4,000 Hz (at 2.4 cm position)		
Speaker	5 cm (2 inches) dia.		
Power output	300 mW		
Input	MIC (PLUG IN POWER): minijack, sensitivity 0.3 mV for 3 kilohm or lower impedance		
Output	EARPHONE: minijack, for an 8–300 ohm earphone		
Power requirements	DC IN 9 V jack accepts the supplied AC power adaptor.		

Design and specifications subject to change without notice.

Optional Accessories

Microphone ECM-F01, ECM-K7
Microcassette MC-30, MC-60, 3MC-60
Cassette eraser BE-9H
Telephone pick-up TL-2, TP-15
Telephone recording adaptor TL-4

Your dealer may not handle some of the above listed optional accessories. Please ask the dealer for detailed information about the optional accessories available in your country.

Troubleshooting Guide

Should a problem occur, first check the following basic points. If the problem persists after you have made these checks, consult your nearest Sony dealer.

Symptom	Cause and /or remedy
The unit does not operate.	<ul style="list-style-type: none">• Connect the AC power adaptor to a wall outlet.
No sound from the built-in speaker.	<ul style="list-style-type: none">• Turn up the volume.• The earphone is plugged in.
The tape speed is too fast or too slow.	<ul style="list-style-type: none">• Set the SPEED selector correctly.• Adjust the SPEED CONTROL.
The tape stops in the rewind or fast forward mode and the alarm sounds.	<ul style="list-style-type: none">• The entire tape has been wound onto the right or left reel.
Sound drop-outs, loss of high frequency sounds, or excessive noise.	<ul style="list-style-type: none">• The heads are dirty. See "Maintenance".
No sound from the earphones.	<ul style="list-style-type: none">• The VOLUME control is set in the 0 position.• The earphone is not plugged in correctly.
The tape does not move when either the hand control unit or foot control unit is used.	<ul style="list-style-type: none">• The plug is not connected correctly.• Release the STOP button on the unit before operation.