

WASHING MACHINE

เครื่องซักผ้า

MÁY GIẶT

MESIN CUCI

# INSTRUCTION BOOKLET

## คู่มือการใช้งาน HƯỚNG DẪN SỬ DỤNG BUKU PETUNJUK

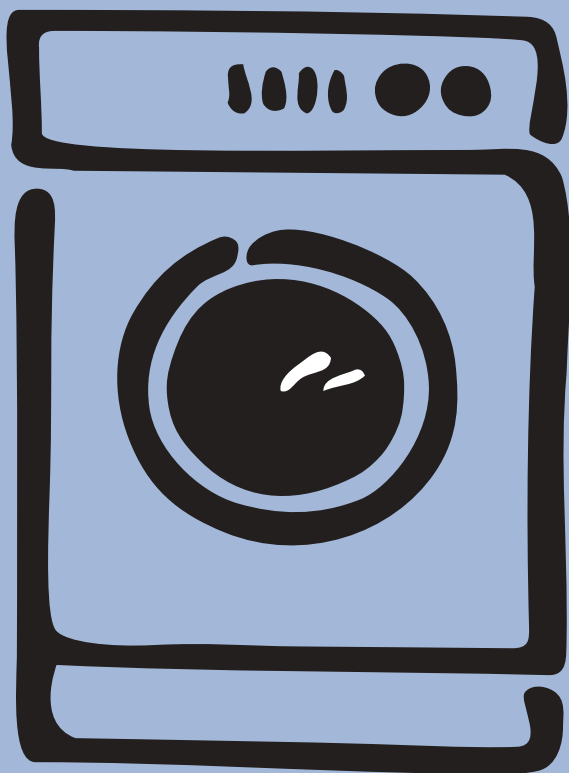

EW 560 F  
EW 660 F

## Dear customer,

Please read these operating instructions carefully and pay particular attention to the safety notes indicated in the first pages. We recommend that you keep this instruction booklet for future reference and pass it on to any future owners.

## Transport damages

When unpacking the appliance, check that it is not damaged. If in doubt, do not use it and contact the Service Centre.

The symbols you will see on some paragraphs of this booklet have the following meaning:



The warning triangle and/or the key words (Warning!, Caution!) emphasize information that is particularly important for your safety or correct functioning of the appliance.



The information marked with this symbol provides additional instructions and practical tips on the use of the appliance.



Tips and information about economical and ecological use of the machine are marked with this symbol.

***Our contribution to the protection of the environment: we use environmentally friendly paper.***

# Contents

<b>Warnings</b>	<b>3-4</b>	Washing hints	9
<b>Disposal</b>	<b>4</b>	Sorting the laundry	9
<b>Tips for environmental protection</b>	<b>4</b>	Temperatures	9
<b>Technical specifications</b>	<b>4</b>	Before loading the laundry	9
<b>Installation</b>	<b>5</b>	Maximum loads	9
Unpacking	5	Laundry weights	9
Positioning	5	Removing stains	9
Water inlet	5	Detergents and additives	10
Water drainage	6	Operating sequence	11-12
Electrical connection	6	International wash code symbols	13
<b>Your new washing machine</b>	<b>7</b>	Washing programmes	14-15
<b>Description of the appliance</b>	<b>7</b>	<b>Maintenance</b>	<b>16</b>
Detergent dispenser drawer	7	Door seal	16
<b>Use</b>	<b>8</b>	Bodywork	16
Control panel	8	Detergent dispenser drawer	16
Controls	8	Drain pump	16-17
		Water inlet filter	17
		Emergency emptying out	17
		Frost precautions	17
		<b>Something not working?</b>	<b>18-19</b>

# Warnings

The following warnings are provided in the interests of overall safety. You must read them carefully before installing or using the appliance.

## Installation

- All internal packing must be removed before using the appliance. Serious damage may be caused to the machine or adjacent furniture if the protective transit devices are not removed or are not completely removed. Refer to the relevant paragraph in the instruction book.
- Any electrical work required to install this appliance must be carried out by a qualified electrician.
- Any plumbing work required to install this appliance must be carried out by a qualified plumber.
- After having installed the machine, check that it is not standing on its electrical supply cable.
- If the appliance is placed on a carpeted floor, ensure that air can circulate freely between the feet and the floor.

## Use

- This appliance is designed for domestic use. It must not be used for purposes other than those for which it was designed.
- Only wash fabrics which are designed to be machine washed. Follow the instructions on each garment label.
- Do not overload the appliance. Follow the instructions in the instruction book.
- Make sure that all pockets are empty. Objects such as coins, safety pins, pins and screws can cause extensive damage.
- Do not machine wash garments saturated with petroleum, methylated spirits, trichlorethylene, etc. If such fluids have been used to remove stains prior to washing, wait until they have completely evaporated from the fabric before placing garments in the appliance.
- Place small items such as socks, belts, etc. in a cloth bag or pillowcase to prevent them getting trapped between the drum and the tub.

- Use only the recommended quantities of fabric softener. An excessive amount could damage the laundry.
- Leave the porthole door slightly ajar when the appliance is not in use. This preserves the door seal and prevents the formation of musty smells.
- Always check that water has emptied out before opening the door. If not, drain the water following the instructions in the instruction book.
- Always unplug the appliance and shut the water tap after use.

## General safety

- Repairs to the machine must be carried out only by qualified personnel. Repairs carried out by inexperienced persons could cause serious danger. Contact your local Service Centre.
- Never pull the power supply cable to remove the plug from the socket; always take hold of the plug itself.
- During high temperature wash programmes the door glass may get hot. Do not touch it!

## Child safety

- Children are often not aware of how dangerous electrical appliances can be. When the machine is working, children should be carefully supervised and not be allowed to play with the appliance.
- The packaging components (e.g. plastic film, polystyrene) can be dangerous to children - danger of suffocation! Keep them out of children's reach.
- Keep all detergents in a safe place out of children's reach.
- Make sure that children or pets do not climb into the drum.
- When the appliance is to be scrapped, cut off the electrical supply cable and destroy the plug with the remaining cable. Disable the door catch in order to prevent children from becoming trapped inside while playing.

# Disposal

## Packaging materials

The materials marked with the symbol  are recyclable.

>PE<=polyethylene

>PS<=polystyrene

>PP<=polypropylene

This means that they can be recycled by disposing of them properly in appropriate collection containers.

## Machine

Use authorised disposal sites for your old appliance. Help to keep your country tidy!

# Tips for environmental protection

To save water, energy and to help protect the environment, we recommend that you follow these tips:

- Normally soiled laundry may be washed without prewashing in order to save detergent, water and time (the environment is protected too!).
- The machine works more economically if it is fully loaded.
- With adequate pre-treatment, stains and limited soiling can be removed; the laundry can then be washed at a lower temperature.
- Measure out detergent according to the water hardness, the degree of soiling and the quantity of laundry being washed.

# Technical specifications

DIMENSIONS	Height	85 cm
	Width	60 cm
	Depth	59 cm
MAXIMUM LOAD	Cotton	5.5 kg
	Synthetics	2.5 kg
	Delicates	2.5 kg
	Woollens	1 kg
SPIN SPEED		550 rpm max. <b>(EW 560 F)</b> 650 rpm max. <b>(EW 660 F)</b>
POWER SUPPLY VOLTAGE/FREQUENCY		220-230 V/50 Hz
TOTAL POWER ABSORBED		2200 W
MINIMUM FUSE PROTECTION		10 A
WATER PRESSURE	Minimum	50 kPa
	Maximum	800 kPa



This appliance complies with the following EEC Directives:

73/23/EEC of 19/02/73 relating to low voltage

89/336/EEC of 03/05/89 relating to electromagnetic compatibility.

# Installation

## Unpacking

**!** All transit bolts and packing must be removed before using the appliance.

You are advised to keep all transit devices so that they can be refitted if the machine ever has to be transported again.

- Using a spanner, unscrew and remove the rear right-hand bolt and lay the machine on its back, taking care not to squash the hoses. This can be avoided by placing one of the corner packing pieces between the machine and the floor.

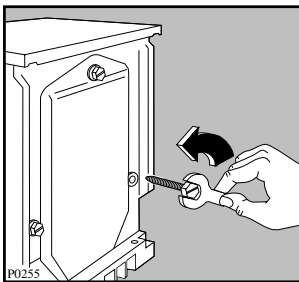

- Remove the polystyrene block from the bottom of the machine and release the two plastic bags.
- Carefully remove the right-hand bag (1) then the left-hand bag (2) by pulling them towards the centre of the machine.
- Unscrew and remove the feet.

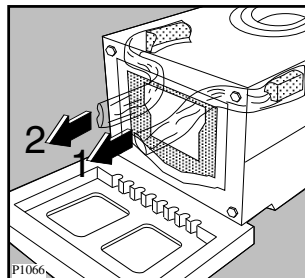
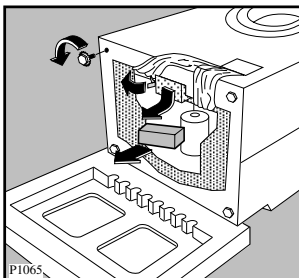

- Fit the grid (A) on the bottom of the machine using the four screws (B) you will find in the bag containing the instruction booklet. Re-fit the feet.

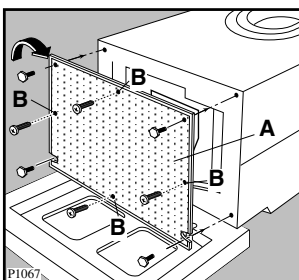

- Set the machine upright and remove the two remaining bolts from the back.

- Pull out the three plastic spacers from the holes into which the bolts were fitted.
- Plug all the holes with the plugs which you will find in the envelope containing the instruction booklet.

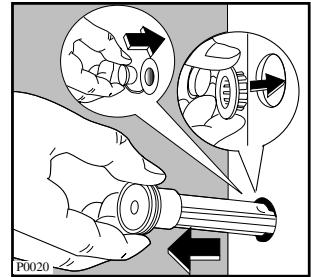
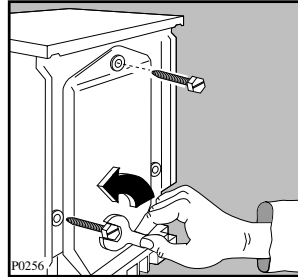

## Positioning

Install the machine on a flat hard floor. Make sure that air circulation around the machine is not impeded by carpets, rugs etc. Check that the machine does not touch the wall or other kitchen units.

Carefully level by screwing the adjustable feet in or out. Never place cardboard, wood or similar materials under the machine to compensate for any unevenness in the floor.

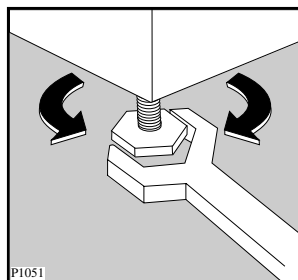

## Water inlet

Connect the water inlet hose supplied with the machine to a tap with a 3/4" thread.

Do not use already employed hoses.

The other end of the inlet hose which connects to the machine can be turned in any direction. Simply loosen the fitting, rotate the hose and retighten the fitting, making sure there are no water leaks.

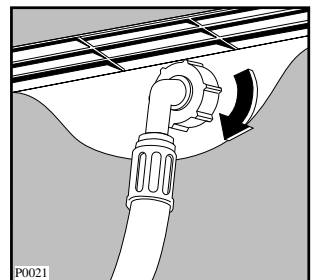
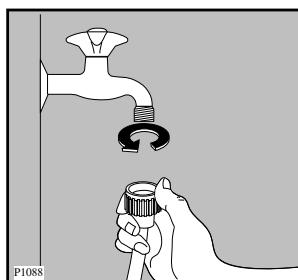

The inlet hose must not be lengthened. If it is too short and you do not wish to move the tap, you will have to purchase a new, longer hose specially designed for this type of use.

### Important!

Before connecting up the machine to new pipework or to pipework that has not been used for some time, run off a reasonable amount of water to flush out any debris that may have collected in the pipes.

## Water drainage

The end of the drain hose can be positioned in three ways:

**Hooked over the edge of a sink using the plastic hose guide supplied with the machine.** In this case, make sure the end cannot come unhooked when the machine is emptying.

This could be done by tying it to the tap with a piece of string or attaching it to the wall.

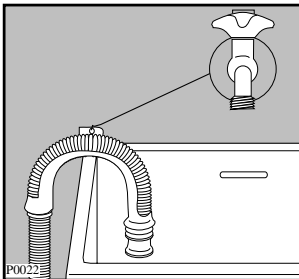

**In a sink drain pipe branch.** This branch must be above the trap so that the bend is at least 60 cm above the ground.

**Directly into a drain pipe at a height** of not less than 60 cm and not more than 90 cm.

The end of the drain hose must always be **ventilated**, i.e. the inside diameter of the drain pipe must be larger than the outside diameter of the drain hose.

The drain hose must not be kinked.

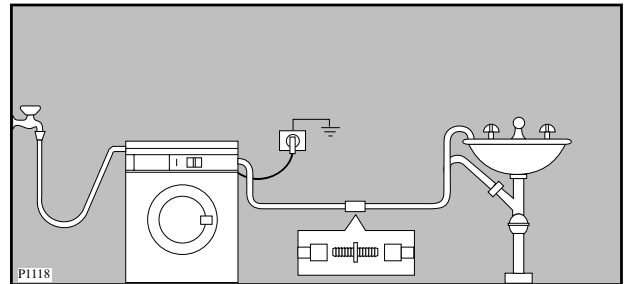

**For a correct functioning of the machine the drain hose must remain hooked on the proper support piece situated on the top part of the back side of the appliance.**

## Electrical connection

This machine is designed to operate on a 220-230 V, single-phase, 50 Hz supply.

Check that your domestic electrical installation can take the maximum load required (2.2 kW), also taking into account any other appliances in use.

**Connect the machine to an earthed socket.**



The manufacturer declines any responsibility for damage or injury through failure to comply with the above safety precaution.

Should the appliance power supply cable need to be replaced, this should be carried out by our Service Centre.

**The power supply cable must be easily accessible after installing the appliance.**

# Your new washing machine

This new machine meets all modern needs for effective treatment of laundry with low water, energy and detergent consumption.



- **The temperature selector dial** will allow you to choose the most suitable temperature for your laundry.
- The **automatic cooling of the washing water** from 95° to 60°C before draining will prevent old drain pipes from being deformed and will reduce thermal shock to fabrics, helping to prevent creasing.
- **The special wool programme** with its new delicate wash system treats your woollens with extreme care.
- **The unbalance control device** ensures the machine is stable during the spin.
- **The ECO valve** allows total use of detergent and reduces water consumption so saving energy.

## Description of the appliance

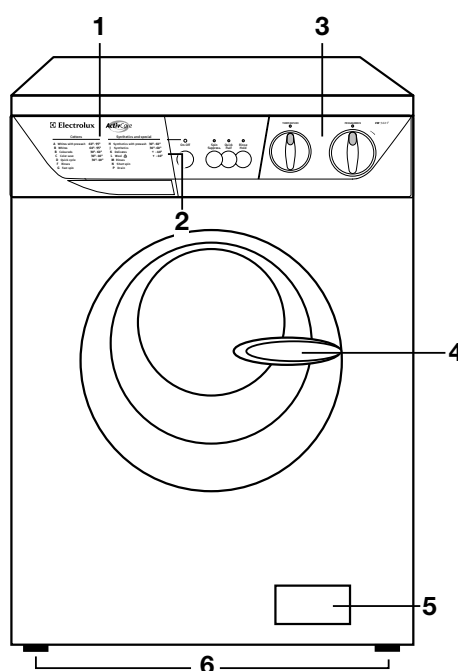
- 1 Detergent dispenser drawer
- 2 Programme chart
- 3 Control panel
- 4 Door handle
- 5 Drain pump
- 6 Adjustable feet



### Detergent dispenser drawer

-  Prewash
-  Main wash
-  Fabric softener, starch

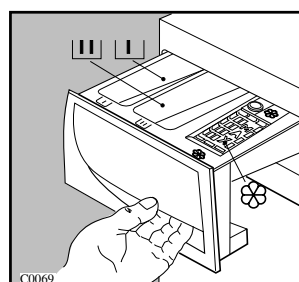

# Use

## Control panel

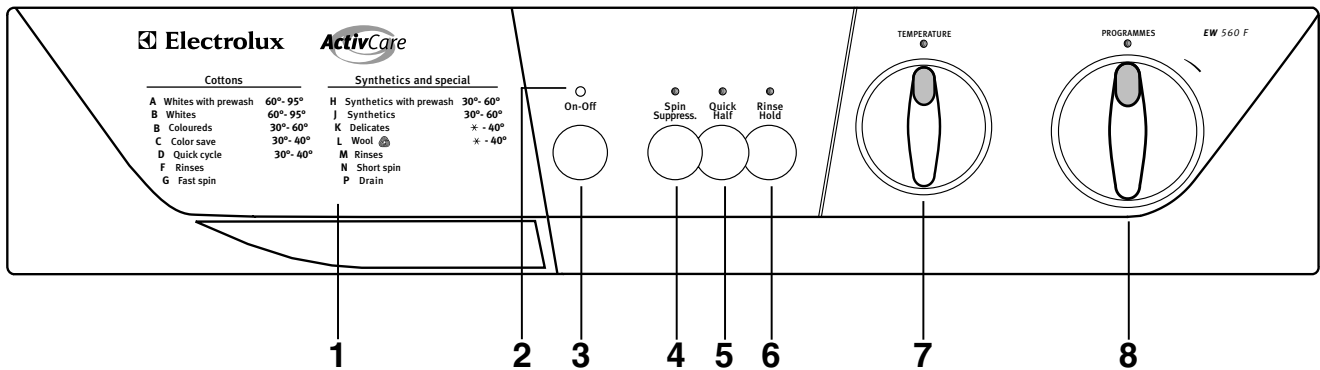

### 1 Detergent dispenser drawer and programme chart

### 2 Mains-on light

This light comes on when the On-Off button is pressed, and goes out when it is pressed again.

### 3 On-Off button

Press this button to start the machine. The same button is used to switch the machine off.

**Before selecting a programme or changing an ongoing programme the machine must be switched off by depressing the On-Off button.**

### 4 Spin Suppress. button

Select this button when you have to wash particularly delicate cotton or linen items in order to exclude all the spinning phases.

### 5 Quick Half button

Select this button to reduce water consumption on the rinse cycle when washing a smaller load of cottons (maximum load size = 2,5 kg).

### 6 Rinse Hold button

Press this button to make the machine stop with water in the drum after the cotton, synthetic or delicate wash cycles.

This prevents any creasing which may occur if the clothes are left damp in the drum. When it is convenient for you to empty the machine, simply press this button again so that the machine can proceed to drain the water, or select the programme **N** (short spin).

If this button is not activated, the washing programmes will end with a spin.

### 7 Temperature selector dial

Turn this dial to select the washing temperature. Position  $\times$  = cold wash.

### 8 Programme selector dial

To select the required programme, turn this dial **clockwise** until the programme letter is exactly opposite the pointer.

Before selecting a programme or changing a programme in progress the machine must be switched off by depressing ON-OFF button.



## **i** Washing hints

### Sorting the laundry

Follow the wash code symbols on each garment label and the manufacturer's washing instructions. Sort the laundry as follows: whites, coloureds, synthetics, delicates, woollens.

### Temperatures

- 95°** for normally soiled white cottons and linen (e.g. tea cloths, towels, tablecloths, sheets...)
- 60°** for normally soiled, colour fast garments (e.g. shirts, night dresses, pyjamas....) in linen, cotton or synthetic fibres and for lightly soiled white cotton (e.g. underwear).
- \* (cold) 30°-40°** for delicate items (e.g. net curtains), mixed laundry including synthetic fibres and woollens.

### Before loading the laundry

Never wash whites and coloureds together. Whites may lose their "whiteness" in the wash.

New coloured items may run in the first wash; they should therefore be washed separately the first time.

**Make sure that no metal objects are left in the laundry (e.g. hair clips, safety pins, pins).**

Button up pillowcases, close zip fasteners, hooks and poppers. Tie any belts or long tapes.

Remove persistent stains before washing. Rub particularly soiled areas with a special detergent or detergent paste.

Treat curtains with special care. Remove hooks or tie them up in a bag or net.

### Maximum loads

Recommended loads are indicated in the programme charts.

General rules:

**Cotton, linen:** drum full but not too tightly packed;

**Synthetics:** drum no more than half full;

**Delicate fabrics and woollens:** drum no more than one third full.

Washing a maximum load makes the most efficient use of water and energy.

For heavily soiled laundry, reduce the load size.

## Laundry weights

The following weights are indicative:

bathrobe	1200 g
napkin	100 g
quilt cover	700 g
sheet	500 g
pillow case	200 g
tablecloth	250 g
towelling towel	200 g
tea cloth	100 g
night dress	200 g
ladies' briefs	100 g
man's work shirt	600 g
man's shirt	200 g
man's pyjamas	500 g
blouse	100 g
men's underpants	100 g

### Removing stains

Stubborn stains may not be removed by just water and detergent. It is therefore advisable to treat them prior to washing.

**Blood:** treat fresh stains with cold water. For dried stains, soak overnight in water with a special detergent then rub in the soap and water.

**Oil based paint:** moisten with benzine stain remover, lay the garment on a soft cloth and dab the stain; treat several times.

**Dried grease stains:** moisten with turpentine, lay the garment on a soft surface and dab the stain with the fingertips and a cotton cloth.

**Rust:** oxalic acid dissolved in hot water or a rust removing product used cold. Be careful with rust stains which are not recent since the cellulose structure will already have been damaged and the fabric tends to hole.

**Mould stains:** treat with bleach, rinse well (whites and fast coloureds only).

**Grass:** soap lightly and treat with bleach (whites and fast coloureds only).

**Ball point pen and glue:** moisten with acetone (\*), lay the garment on a soft cloth and dab the stain.

**Lipstick:** moisten with acetone as above, then treat stains with methylated spirits. Remove any residual marks from white fabrics with bleach.

**Red wine:** soak in water and detergent, rinse and treat with acetic or citric acid, then rinse. Treat any

residual marks with bleach.

**Ink:** depending on the type of ink, moisten the fabric first with acetone (\*), then with acetic acid; treat any residual marks on white fabrics with bleach and then rinse thoroughly.

**Tar stains:** first treat with stain remover, methylated spirits or benzine, then rub with detergent paste.

**(\*) do not use acetone on artificial silk.**

## Detergents and additives

Good washing results also depend on the choice of detergent and use of the correct quantities to avoid waste and protect the environment. Although biodegradable, detergents contain substances which, in large quantities, can upset the delicate balance of nature.

The choice of detergent will depend on the type of fabric (delicates, woollens, cottons, etc.), the colour, washing temperature and degree of soiling.

All commonly available washing machine detergents may be used in this appliance:

- powder detergents for all types of fabric,
- powder detergents for delicate fabrics (60°C max) and woollens,
- liquid detergents, preferably for low temperature wash programmes (60°C max) for all types of fabric, or special for woollens only.

The detergent and any additives must be placed in the appropriate compartments of the dispenser drawer before starting the wash programme.

If using concentrated powder or liquid detergents, a programme **without** prewash must be selected.

The washing machine incorporates a recirculation system which allows an optimal use of the concentrated detergent.

Pour liquid detergent into the dispenser drawer compartment marked  **just before** starting the programme.

Any fabric softener or starching additives must be poured into the compartment marked  before starting the wash programme.

Follow the product manufacturer's recommendations on quantities to use and **do not exceed the «MAX» mark in the detergent dispenser drawer.**

## Quantity of detergent to be used

The type and quantity of detergent will depend on the type of fabric, load size, degree of soiling and hardness of the water used.

Water hardness is classified in so-called "degrees" of hardness. Information on hardness of the water in your area can be obtained from the relevant water supply company, or from your local authority.

Follow the product manufacturers' instructions on quantities to use.

Use less detergent if:

- you are washing a small load,
- the laundry is lightly soiled,
- large amounts of foam form during washing.

## **i** Operating sequence

Before the first wash we recommend that you pour 2 litres of water into the main wash compartment  of the detergent drawer in order to activate the ECO valve. Then run a cotton cycle at 60°C, with the machine empty, in order to remove any manufacturing residue from the drum and tub. Pour half a measure of detergent into the main wash compartment and start up the machine.

### 1. Place the laundry in the drum

Open the door.

Place the laundry in the drum, one item at a time, shaking them out as much as possible.

Close the door.

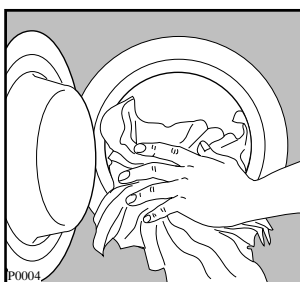

### 2. Measure out the detergent

Pull out the dispenser drawer until it stops. Measure out the amount of detergent recommended by the manufacturer in a graduated cup and pour it into the main wash compartment .

If you wish to carry out the prewash, pour detergent into the appropriate compartment marked .

### 3. Measure out the additive

If required, pour fabric softener into the compartment marked , without exceeding the «MAX» mark.

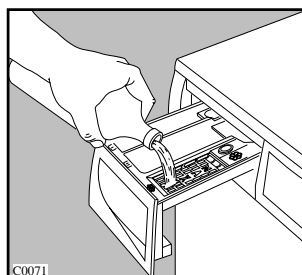
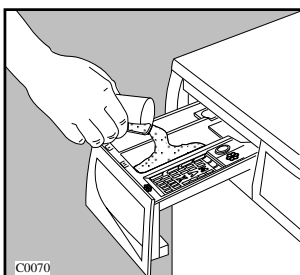

### 4. Select the desired option(s)

Depress one or more buttons depending on the selected programme.

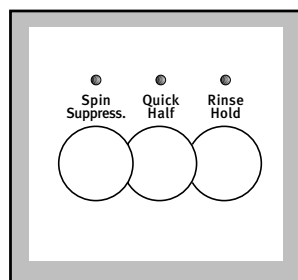

### 5. Select the temperature

Turn the dial to the required setting.

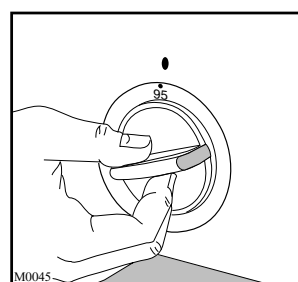

### 6. Select the programme and start the machine

Turn the programme selector dial **clockwise** to the required programme and press the On-Off button : the mains on light comes on and the machine starts to operate.

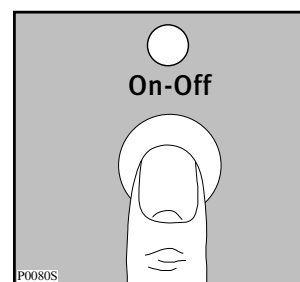
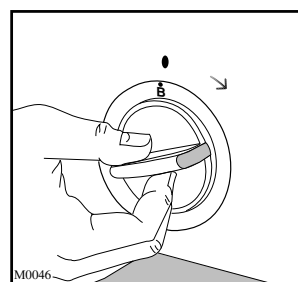

## 7. At the end of the programme

The machine stops automatically.

If you have selected the Rinse Hold button or the Spin Suppress. one, the machine will stop with the water left in the tub, to prevent the fabric from creasing. To drain the water release the same button. To drain and spin, select programme **N** (short spin).

Depress the On-Off button again to switch the machine off. The mains on light goes out.

Wait one or two minutes before opening the door to give the electric locking mechanism time to release it.

Remove the laundry.

Turn the drum by hand to make sure it is completely empty, so as to avoid any forgotten items being damaged in a subsequent wash (e.g. shrinking) or their colour running into a load of whites.













Release any buttons which have been pressed.



Turn the water tap off and unplug the machine.





Leave the door ajar to air the machine.





## **i** International wash code symbols







These symbols appear on fabric labels, in order to help you choose the best way to treat your laundry.

<b>Energetic wash</b>   <b>Delicate wash</b>	 Max. wash temperature 95°C	 Max. wash temperature 60°C	 Max. wash temperature 40°C	 Max. wash temperature 30°C	 Hand wash	 Do not wash at all
	 Max. wash temperature 60°C	  Max. wash temperature 40°C	 Max. wash temperature 30°C			

 <b>Bleaching</b>	 Bleach in cold water	 Do not bleach
---	---	--

 <b>Ironing</b>	 Hot iron max 200°C	 Warm iron max 150°C	 Lukewarm iron max 110°C	 Do not iron
---	---	--	---	--

 <b>Dry cleaning</b>	 Dry cleaning in all solvents	 Dry cleaning in perchlorethylene, petrol, pure alcohol, R 111 & R 113	 Dry cleaning in petrol, pure alcohol and R 113	 Do not dry clean
--	---	--	--	---

 <b>Drying</b>	 Flat	 On the line	 On clothes hanger	 high temperature  low temperature Tumble dry	 Do not tumble dry
--	---	--	--	---	--

# Programme table

## Washing programmes for cotton and linen

Max. load 5.5 kg

Programme	Temp.	Fabrics	Programme description	Additional functions
<b>A</b>	60°-95°	WHITES WITH PREWASH, for example work garments, sheets, household linen, underwear, towels	Prewash at 40°C Wash at 60°-95°C 4 rinses Long spin	<b>Spin Suppress. Quick Half</b>
<b>B</b>	60°-95°	WHITES WITHOUT PREWASH, for example household linen, sheets, shirts, underwear	Wash at 60°-95°C 4 rinses Long spin	<b>Spin Suppress. Quick Half</b>
<b>B</b>	30°-60°	COLOURED WITHOUT PREWASH, for example shirts, blouses, terry cloths, underwear	Wash at 30°-60°C 4 rinses Long spin	<b>Spin Suppress. Quick Half</b>
<b>C Color save</b>	30°-40°	Cotton and linen with delicate colours	Wash at 30°-40°C 4 rinses Long spin	<b>Spin Suppress. Quick Half</b>
<b>D Quick Cycle</b>	30°-40°	This programme can be used for lightly soiled items.	Wash at 30°-40°C 4 rinses Long spin	<b>Spin Suppress. Quick Half</b>
<b>F Rinses</b>	COLD	This programme can be used for rinsing hand washed garments	4 rinses with additive if required Long spin	<b>Spin Suppress. Quick Half</b>
<b>G Fast spin</b>		Separate spin for cotton and linen	Drain and long spin	

The temperatures indicated are the optimum temperatures for each programme and depend on the type of laundry and degree of soiling.



### Important!

- Programme **B** begins with a short drain, then the programme selector dial advances automatically to the water filling position.
- We suggest you not to switch the appliance off and on during its operation. This would modify the memorised programme in progress with unsatisfactory washing results.

# Programme table

## Washing programmes for synthetics, mixed fabrics, delicates and wool

Max. load 2.5 kg, wool 1 kg

Programme	Temp.	Fabrics	Programme description	Additional functions
<b>H</b>	30°-60°	SYNTHETICS WITH PREWASH, for example underwear, coloured items, shirts, blouses	Prewash at 40°C Wash at 30°-60°C 3 rinses Short spin	<b>Rinse Hold</b>
<b>J</b>	30°-60°	SYNTHETICS WITHOUT PRE-WASH, for example shirts, blouses, mixed fabrics	Wash at 30°-60°C 3 rinses Short spin	<b>Rinse Hold</b>
<b>K</b>	✘-40°	DELICATES, for example curtains	Wash at ✘-40°C 3 rinses Short spin	<b>Rinse Hold</b>
<b>L</b> <b>Wool</b> 	✘-40°	<b>WOOL</b>  Special programme for garments bearing the "Pure new wool, non-shrink, machine washable" label	Wash at ✘-40°C 3 rinses Short spin	<b>Rinse Hold</b>
<b>M</b> <b>Rinses</b>	COLD	This programme can be used for rinsing hand washed garments	3 rinses with additive if required Short spin	<b>Rinse Hold</b>
<b>N</b> <b>Short spin</b>	COLD	Separate spin for synthetics, delicates and wool	Drain and short spin	
<b>P</b> <b>Drain</b>		For emptying out the water of the last rinse of the programmes with Rinse Hold option.	Water drainage	

The temperatures indicated are the optimum temperatures for each programme and depend on the type of laundry and degree of soiling.

### Important!

- Programme **J** for synthetics and **L** for wool begin with a short drain, then the programme selector dial advances automatically to the water filling position.
- We suggest you not to switch the appliance off and on during its operation. This would modify the memorised programme in progress with unsatisfactory washing results.

# Maintenance

## 1. Door seal

Check from time to time the door seal and eliminate eventual possible objects that could be trapped in the fold.

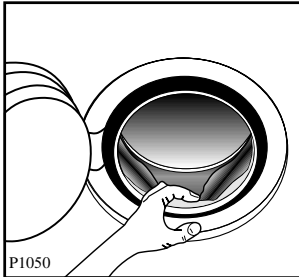

## 2. Bodywork

Clean the outside of the machine with warm water and a detergent used to handwash dishes. Rinse with clean water and dry with a soft cloth.

**Important:** do not use methylated spirits, solvents or similar products to clean the bodywork.

## 3. Detergent dispenser drawer

After a while, detergents and fabric softeners leave deposits in the drawer.

Clean the drawer from time to time by rinsing it under a running tap. To remove the drawer from the machine, press the button in the rear left-hand corner.

To facilitate cleaning, the top part of the additive compartments can be removed.

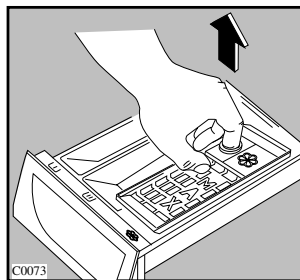
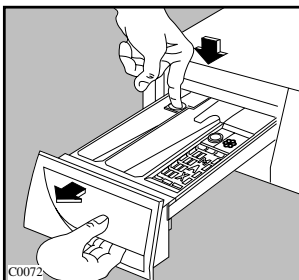

Detergent can also accumulate inside the drawer recess: clean it with an old toothbrush. Refit the drawer after cleaning.

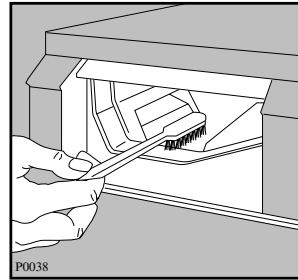

## 4. Drain pump

The pump should be inspected regularly and particularly if

- the machine does not empty and/or spin
- the machine makes an unusual noise during draining due to objects such as safety pins, coins etc. blocking the pump.

Proceed as follows:

- Disconnect the appliance.
- If necessary wait until the water has cooled down.
- Open the pump door.

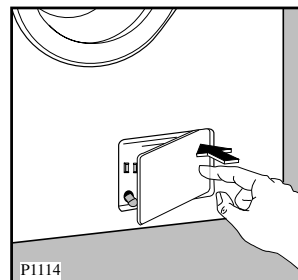

- Place a container close to the pump to collect any spillage.
- Release the emergency emptying hose, place it in the container and remove its cap.
- When no more water comes out, unscrew the pump and remove it. Always keep a rag nearby to dry up spillage of water when removing the pump.

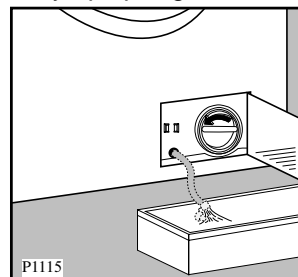



- Remove any objects from the pump impeller by rotating it.

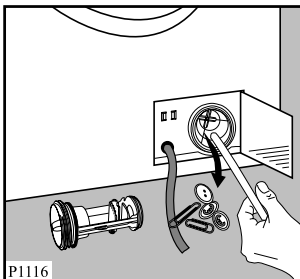

- Put the cap back on the emergency emptying hose and place the latter back in its seat.

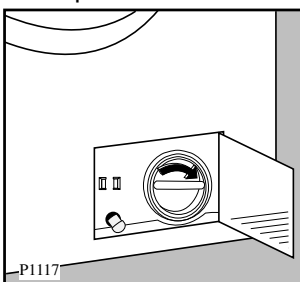

- Screw the pump fully in.
- Close the pump door.

## 5. Water inlet filter

If you notice that the machine is taking longer to fill, check that the filter in the water inlet hose is not blocked.

Turn off the water tap.

Unscrew the hose from the tap.

Clean the filter with a stiff brush.

Screw the hose back onto the tap.

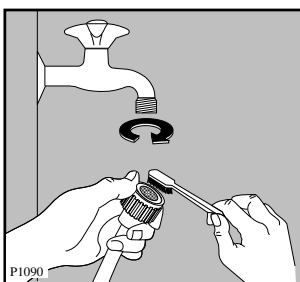

## 6. Emergency emptying out

If the water is not discharged, proceed as follows to empty out the machine:

- pull out the plug from the power socket;
- close the water tap;
- if necessary, wait until the water has cooled down;
- open the the pump door;
- place a bowl on the floor and place the end of the emergency emptying hose into the bowl. Remove its cap. The water should drain by gravity into the bowl. Whe the bowl is full, put the cap back on the hose. Empty the bowl. Repeat the procedure until water stops flowing out;
- clean the pump if necessary as previously described;
- replace the emergency emptying hose in its seat after having plugged it;
- screw the pump again and close the door.

## 7. Frost precautions

If the machine is installed in a place where the temperature could drop below 0°C, proceed as follows:

- Remove the plug from the socket.
- Close the water tap and unscrew the water inlet hose from the tap.
- Place the end of the emergency emptying hose and that of the inlet hose in a bowl placed on the floor and let water drain out.
- Screw the water inlet hose back on and reposition the emergency emptying hose after having put the cap on again.

By doing this, any water remaining in the machine is removed, avoiding the formation of ice and, consequently, breakage of the affected parts.

When you use the machine again, make sure that the ambient temperature is above 0°C.

### Important!

Every time you drain the water through the emergency emptying hose you must pour 2 litres of water into the main wash compartment of the detergent drawer and then run the drain programme. This will activate the ECO valve avoiding that part of the detergent remains unused at next washing.

# Something not working?

*Problems which you can resolve yourself.*

Problem	Possible cause
<ul style="list-style-type: none"> <li>• <b>The machine does not start up:</b></li> </ul>	<ul style="list-style-type: none"> <li>• The door is not firmly closed.</li> <li>• The machine is not plugged in or there is no power at the socket.</li> <li>• The main fuse has blown.</li> <li>• The programme selector dial is not positioned correctly.</li> <li>• The On-Off button has not been depressed.</li> </ul>
<ul style="list-style-type: none"> <li>• <b>The machine does not fill:</b></li> </ul>	<ul style="list-style-type: none"> <li>• The water tap is closed.</li> <li>• The inlet hose is squashed or kinked.</li> <li>• The filter in the inlet hose is blocked.</li> <li>• The door is not properly closed.</li> </ul>
<ul style="list-style-type: none"> <li>• <b>The machine fills then empties immediately:</b></li> </ul>	<ul style="list-style-type: none"> <li>• The end of the drain hose is too low. Refer to relevant paragraph in “water drainage” section.</li> </ul>
<ul style="list-style-type: none"> <li>• <b>The machine does not empty and/or does not spin:</b></li> </ul>	<ul style="list-style-type: none"> <li>• The drain hose is squashed or kinked.</li> <li>• The Rinse Hold option has been selected.</li> <li>• The Spin Suppress. option has been selected.</li> <li>• The drain pump is clogged.</li> </ul>
<ul style="list-style-type: none"> <li>• <b>There is water on the floor:</b></li> </ul>	<ul style="list-style-type: none"> <li>• Too much detergent or unsuitable detergent (creates too much foam) has been used.</li> <li>• Check whether there are any leaks from one of the inlet hose fittings. It is not always easy to see this as the water runs down the hose; check to see if it is damp.</li> <li>• The drain hose is damaged.</li> <li>• The cap on the emergency emptying hose has not been replaced after cleaning the filter.</li> </ul>
<ul style="list-style-type: none"> <li>• <b>Unsatisfactory washing results:</b></li> </ul>	<ul style="list-style-type: none"> <li>• Too little detergent or unsuitable detergent has been used.</li> <li>• Stubborn stains have not been treated prior to washing.</li> <li>• The correct temperature was not selected.</li> <li>• Excessive laundry load.</li> </ul>
<ul style="list-style-type: none"> <li>• <b>The machine vibrates or is noisy:</b></li> </ul>	<ul style="list-style-type: none"> <li>• The transit bolts and packing have not been removed.</li> <li>• The support feet have not been adjusted.</li> <li>• The laundry is not evenly distributed in the drum.</li> <li>• Maybe there is very little laundry in the drum.</li> </ul>
<ul style="list-style-type: none"> <li>• <b>The door will not open:</b></li> </ul>	<ul style="list-style-type: none"> <li>• The programme is still running.</li> <li>• The door lock has not been released.</li> <li>• There is water in the drum.</li> </ul>

Problem	Possible cause
<ul style="list-style-type: none"> <li>• <b>Spinning starts late or the laundry is not spun enough:</b></li> </ul>	<ul style="list-style-type: none"> <li>• The electronic unbalance detection device has cut in because the laundry is not evenly distributed in the drum. The laundry is redistributed by reverse rotation of the drum. This may happen several times before the unbalance disappears and normal spinning can resume. If, after 20 minutes, the laundry is still not evenly distributed in the drum, the machine will not spin. If at the end of the programme the laundry is not spun enough, redistribute the load manually and select the spin programme.</li> </ul>

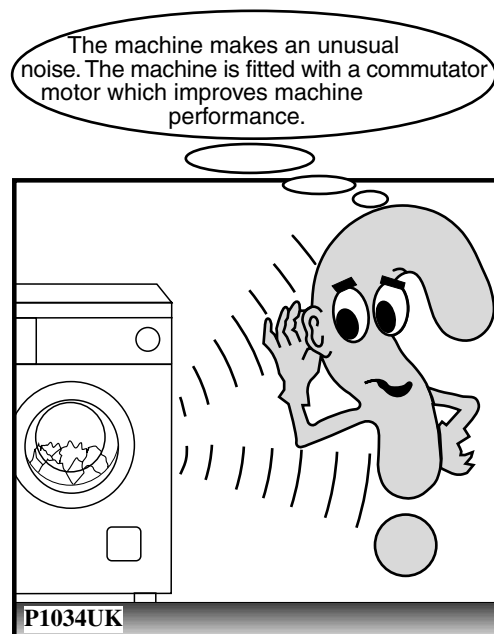
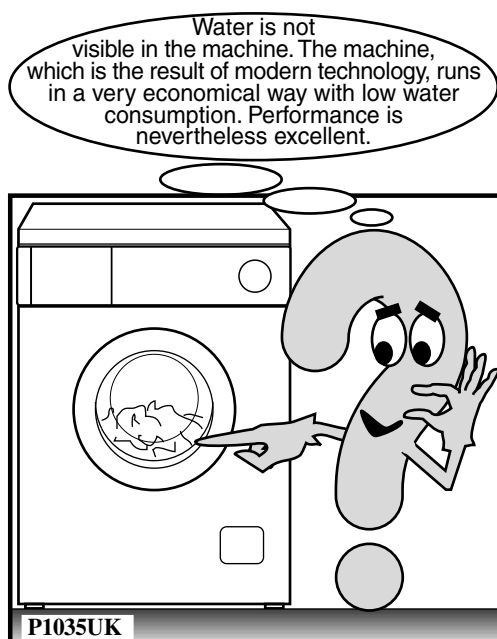

If you are unable to identify or solve the problem, contact our service centre. Before telephoning, make a note of the model, serial number and purchase date of your machine: the Service Centre will require this information.

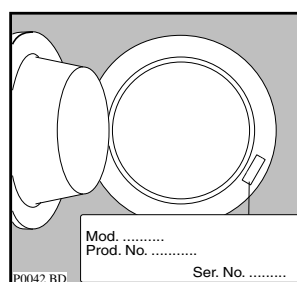



** The Electrolux Group. *The world's No. 1 choice.***

*The Electrolux Group is the world's largest producer of powered appliances for kitchen, cleaning and outdoor use. More than 55 million Electrolux Group products (such as refrigerators, cookers, washing machines, vacuum cleaners, chain saws and lawn mowers) are sold each year to a value of approx. USD 14 billion in more than 150 countries around the world.*