

***Optically Isolated Single Port PCI Bus CE  
RS-232/422/485 Serial Card  
with Send Data Control***

**MODELS: 3PCIOSD1A 3PCIOSD1B**

**Documentation Number 3PCIOSD1x3903m (pn4649-r003)**

This manual applies to models 3PCIOSD1A and 3PCIOSD1B. The "1" suffix designates the number of ports on the card. The "A" models are equipped with 16550A UARTs with 16 byte transmit and receive buffers. The "B" models come with 16850 UARTs with 128 byte transmit and receive buffers. The model number of each card is printed on a sticker on the board.

*This product designed and manufactured in Ottawa, Illinois USA  
of domestic and imported parts by*



***International Headquarters***

B&B Electronics Mfg. Co. Inc.

707 Dayton Road -- P.O. Box 1040 -- Ottawa, IL 61350 USA

Phone (815) 433-5100 -- General Fax (815) 433-5105

**Home Page:** [www.bb-elec.com](http://www.bb-elec.com)

Orders e-mail: [orders@bb-elec.com](mailto:orders@bb-elec.com) -- Fax (815) 433-5109

Technical Support e-mail: [support@bb.elec.com](mailto:support@bb.elec.com) -- Fax (815) 433-5104

***European Headquarters***

B&B Electronics Ltd.

Westlink Commercial Park, Oranmore, Co. Galway, Ireland

Phone +353 91 792444 -- Fax +353 91 792445

**Home Page:** [www.bb-europe.com](http://www.bb-europe.com)

Orders e-mail: [orders@bb-europe.com](mailto:orders@bb-europe.com)

Technical Support e-mail: [support@bb-europe.com](mailto:support@bb-europe.com)

© 2000 B&B Electronics -- Revised October 2003

© 2000 B&B Electronics . No part of this publication may be reproduced or transmitted in any form or by any means, electronic or mechanical, including photography, recording, or any information storage and retrieval system without written consent. Information in this manual is subject to change without notice, and does not represent a commitment on the part of B&B Electronics.

B&B Electronics shall not be liable for incidental or consequential damages resulting from the furnishing, performance, or use of this manual.

All brand names used in this manual are the registered trademarks of their respective owners. The use of trademarks or other designations in this publication is for reference purposes only and does not constitute an endorsement by the trademark holder.

# TABLE OF CONTENTS

<b>CHAPTER 1: GENERAL INFORMATION.....</b>	<b>1</b>
INTRODUCTION .....	1
DESCRIPTION .....	1
FEATURES .....	1
SPECIFICATIONS .....	2
<b>CHAPTER 2: SETUP .....</b>	<b>5</b>
INSPECTION .....	5
RS-232 MODE.....	7
RS-422 MODE.....	8
RS-485 MODE.....	9
INSTALLING THE CARD.....	12
<b>CHAPTER 3: WINDOWS INSTALLATION .....</b>	<b>13</b>
WINDOWS 95 AND WINDOWS 98.....	13
WINDOWS 2000 PROFESSIONAL.....	21
WINDOWS NT 4.0 .....	26
<b>CHAPTER 4: TROUBLESHOOTING.....</b>	<b>33</b>
<b>APPENDIX A: 3PCIOSDxx I/O SCHEMATIC .....</b>	<b>A-1</b>
<b>APPENDIX B: RS-232 &amp; RS-422/485 PINOUTS .....</b>	<b>B-1</b>
<b>APPENDIX C: JUMPER MODE TABLE .....</b>	<b>C-1</b>
<b>APPENDIX D: TROUBLESHOOTING WITH COMTEST .....</b>	<b>D-1</b>
<b>APPENDIX E: ISOLATION AND GROUND .....</b>	<b>E-1</b>
<b>APPENDIX F: RENAMING COM PORTS - WIN 95/98/ME .....</b>	<b>F-1</b>
<b>APPENDIX G: DECLARATION OF CONFORMITY .....</b>	<b>G-1</b>

## Chapter 1: **GENERAL INFORMATION**

### Introduction

The B&B Electronics 3PCIOSD1x single port isolated serial interface card is designed for IBM compatibles with a PCI Bus. The PCI design is Plug and Play compatible which allows the driver and Operating System to select the IRQ and addresses used by the card.

The 3PCIOSD1x cards offer exceptional setup flexibility with a mix of selectable operating modes. If you are writing your own applications, be sure the communications routine used supports Windows communication drivers and a wide range of COM ports.

### Description

The isolated single port can be configured for RS-232, RS-422, or RS-485 data protocols. The RS-485 mode automatic Send Data Control feature transparently handles the enable and disable functions of the RS-485 transceiver. Buffered, high speed UARTs (16550A or 16850) make it ideal for high speed (modem) and multitasking applications.

### Features

- IBM compatible, PCI Version 2.1 bus
- Supports baud rates to 460.8K baud with 4X clock option enabled
- Provides 2000 VDC minimum isolation on all lines from the DB-25 male connector to the host computer
- High speed 16 byte FIFO 16550A UARTs (Model 3PCIOSD1A), 128 byte FIFO 16850 UARTs (Model 3PCIOSD1B)
- RS-485 Automatic Send Data Control or RTS control
- 2-wire or 4-wire RS-485 operation (half or full duplex)
- 120Ω Termination Select Jumper for RS-422/RS-485 Networks
- RS-232 Mode Signal lines: TD, RD, RTS, CTS, DTR, DSR, & DCD, and Signal Ground.
- 2 Channel RS-422 Signal Lines: TD(A), TD(B), RD(A), RD(B) and Signal Ground.

- RS-485 Signal Lines: TD(A), TD(B), RD(A), RD(B) and Signal Ground. (Data A & Data B lines when wired for 2-wire operation.)

### Specifications

Bus: PCI bus version 2.1  
Slot: Requires one PCI slot  
Dimensions: 6.9 x 4.2 in (17.5 x 10.7 cm)  
I/O Connections: One 25-pin male D-sub (DB25M) connector  
OS Supported: Windows 95, 98, 2000 and NT 4.0

Baud rates: 460.8K baud maximum in RS-232/422/485 modes  
UARTs: 16550A 16 byte TX and RX buffers (**3PCIOSD1A**), or  
16850 128 byte TX and RX buffers (**3PCIOSD1B**)

Character length: 5, 6, 7, or 8 bits  
Parity: Even, odd or none  
Stop bits: 1, 1.5, or 2

#### RS-232 Control/Data Lines Drivers/Receivers:

Device: SP211H Transceiver  
High level output voltage: 5.0 V minimum  
Low level output voltage: -5.0 V minimum  
Output current limited to: ±25 mA  
Input high threshold voltage: 1.7 V maximum  
Input low threshold voltage: 0.8 V minimum  
Device will withstand: ±15V

#### RS-422/485 Driver/Receiver:

Device: 75ALS180 or MAX491  
Differential driver output voltage: 1.5 - 6 V  
Differential input high-threshold voltage: 0.2 V maximum  
Differential input low-threshold voltage: -0.2 V minimum

#### Automatic RS-485 Driver Control Timing:

Driver is enabled when data is a logic "0" (start bit). Driver remains enabled for one character transmission time (10 bits of data at current baud rate). Each additional logic "0" resets the timeout.

Termination: A 120Ω termination resistor is jumper selectable on the 422/485 receiver.

*continued next page*

**Optical Isolation:**

Data Line Device: HCPL0600

Handshake Line Device: IL207

Max. Power Consumption: All ports loaded  
+5 V @ 325.0 mA or 1.625 W

**Accessories:**

Software: Driver Disk (3.5) for Windows 95/98/2000/NT 4.0  
PCI/USB COM Port Utility Disk (3.5)

Manual: Instruction Manual (this booklet)

## Chapter 2: SETUP

### Inspection

Your 3PCIOSD1x serial card was tested for proper operation before shipment. It should be in perfect mechanical and electrical condition upon receipt.

The card is normally pre-configured for RS-232 operation.

The data clock speed is set by one jumper to x1 (normal) operation or to x4 operation.

The operating mode of the card is set using 8 jumpers: 4 jumpers select RS-232 operation or RS-422/485 operation, one jumper sets RTS for RS-232 & RS-485 modes or Send Data for RS-485 mode, 2 jumpers select RS-422 or RS-485 operating modes for Receive and Transmit, and the last jumper selects 120 ohm termination for the RS-422 or RS-485 Receive.

Refer to **Jumper Mode Table** in **Appendix C**.

### CAUTION: ELECTROSTATIC SENSITIVE DEVICE

Use ESD precautions for safe handling.

Before removing the card from the anti-static protective packaging:

- Discharge any static electricity buildup on your body by touching a large grounded metal surface or the metal chassis on equipment connected to earth ground by a 3-wire power cord.
- Avoid touching the gold connectors or other parts on the card except as necessary to set the configuration jumpers. After setting the jumpers, ground yourself to the computer chassis before and while inserting the card.
- Remove AC power from the computer and unplug the power cord before inserting the card.
- Retain the ESD bag for handling the card. Save the packaging for storage or shipping.

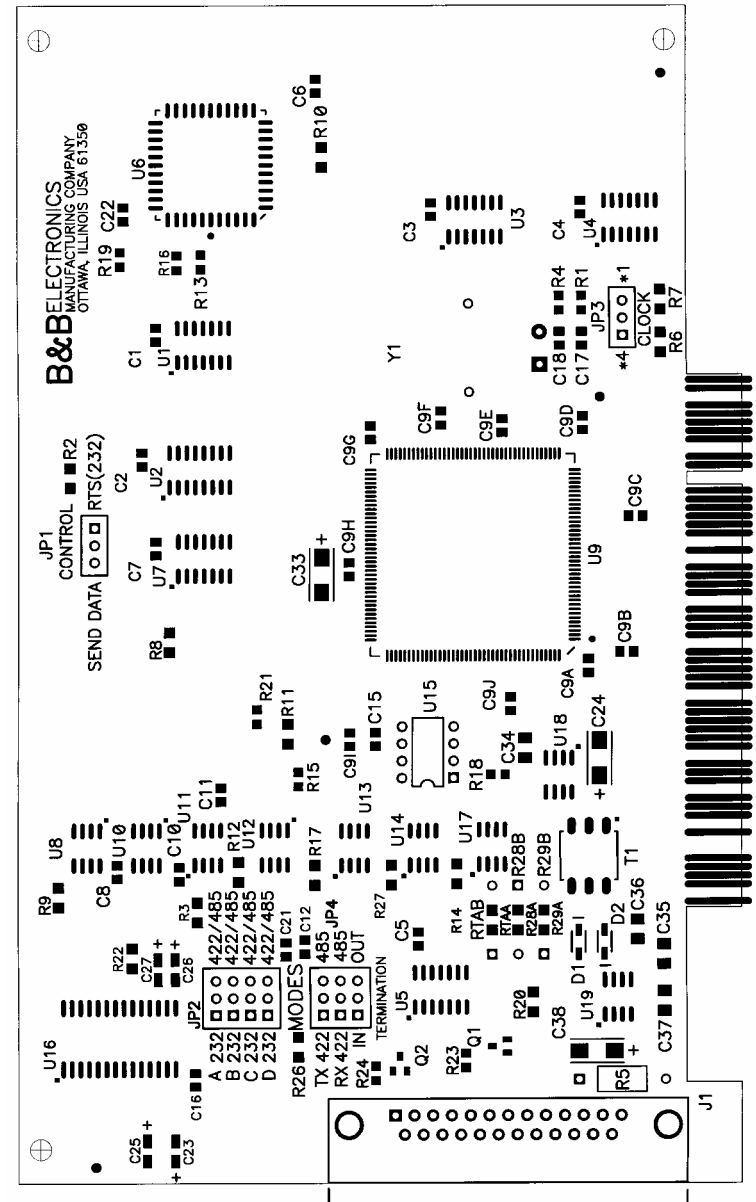

Figure 1. Silk Screen Plot of 3PCIOSD1x PCB

## RS-232 Mode

To configure the port for RS-232 mode, 5 jumpers must be set/checked. The following settings will configure the port as RS-232:

1. Set four jumpers of JP2 (A-D) to the "232" (left) position.
2. Set JP1 to the "RTS(232)" (right) position.

The remaining jumpers, JP4, are unused in the RS-232 mode and may be in either position. Figure 2 shows the jumper configuration to set the port for RS-232 mode with \*1 clock enabled.

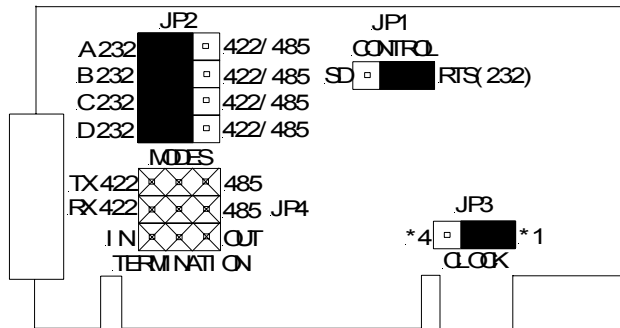

Figure 2. RS-232 Mode Jumper Settings

### RS-232 Pinouts

The DB-25 male connector on the 3PCIOSD1x cards is configured as standard DTE RS-232 serial port. Table 1 lists pin numbers and descriptors.

Name	Description	Direction	DB25M Pin
Shield	Shield	-----	1
TD	Transmit Data	Output	2
RD	Receive Data	Input	3
RTS	Request to Send	Output	4
CTS	Clear to Send	Input	5
DSR	Data Set Ready	Input	6
GND	Signal Ground	-----	7
DCD	Data Carrier Detect	Input	8
DTR	Data Terminal Ready	Output	20

Table 1: RS-232 Pinouts

## RS-422 Mode

To configure the port for RS-422 mode, 7 jumpers must be set/checked. The following settings configure the port as RS-422:

1. Set the four jumpers of JP2 (A-D) to the "422/485" (right) position.
2. Set the top jumper "TX" of JP4 to the "422" (left) position.
3. Set the second jumper "RX" of JP4 to the "422" (left) position.
4. The JP1 Control (SD/RTS) jumper is unused in the RS-422 mode and may be in either position.
5. The bottom jumper "Termination" of JP4 switches the 120Ω receiver termination resistor IN or OUT. Typically this resistor is not used. In some cases using high baud rates and very long cables, termination is needed. See B&B's free **RS-422/485 Application Note**, Termination section, page 16, for more information (available on our websites). Figure 3 shows the jumper configuration to set the port for RS-422 mode with \*1 clock enabled.

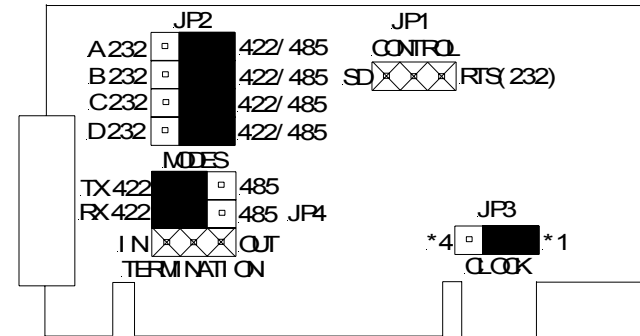

Figure 3. RS-422 Mode Jumper Settings

## RS-422 Pinouts

The RS-422 mode supports 2 channels (transmit and receive).

Name	Description	Direction	DB25M Pin
Shield	Shield	-----	1
TD (A) -	Transmit Data A	Output	2
RD (A) -	Receive Data A	Input	3
GND	Signal Ground	-----	7
TD (B) +	Transmit Data B	Output	14
RD (B) +	Receive Data B	Input	16

**Table 2: RS-422/485 Pinouts**

With 2-wire RS-485 mode operation, your connection cable must jumper TD(A) to RD(A) and TD(B) to RD(B). Connect from TD(A) and TD(B) to the Data A(-) and Data B(+) wires of your RS-485 network.

Note that the EIA RS-422 Specification labels data lines with an "A" and "B" designator. Some RS-422 equipment uses a "-" and "+" designator. In almost all cases, the "A" line is the equivalent of the "-" line and the "B" line is the equivalent of the "+" line. *More information on RS-422 communications can be found in B&B's free RS-422/485 Application Note (available on our websites).*

## RS-485 Mode

To configure the port for RS-485 mode, 8 jumpers must be set/checked. The following settings configure the port as RS-485:

1. Set four jumpers of JP2 (A-D) to the "422/485" (right) position.
2. Set the top jumper "TX" of JP4 to the "485" (right) position.
3. For 2-wire operation, set the second jumper "RX" of JP4 to the "485" (right) position (half duplex). For 4-wire operation, set it to the "422" position (full duplex, Receive enabled)
4. Set the JP1 Control jumper to select the type of RS-485 transmit driver control, automatic Send Data (SD) or RTS . Select SD control unless you are sure that your software requires RTS control.

5. The bottom jumper "Termination" of JP4 switches the 120  $\Omega$  Termination resistor IN or OUT. Typically this resistor is not used. In some cases, using high baud rates and very long cables, termination is needed. See B&B's free **RS-422/485 Application Note**, Termination section, page 16, for more information (available on our websites).

Figure 4 shows the jumper configuration to set the port for 2-wire RS-485 mode with \*1 clock enabled.

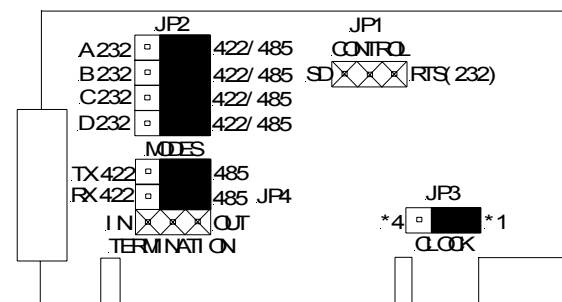

**Figure 4. RS-485 Mode Jumper Settings**

## RS-485 Pinouts

The pinouts in RS-485 mode are the same as those listed in **Table 2: RS-422/485 Pinouts** on the previous page.

## Explanation of RS-485 Operation

In RS-485 mode, the transmit driver must be enabled to transmit, and set to a high impedance (tri-state) mode at the end of transmission. In two wire (half duplex) mode, the receiver is disabled during transmit, and enabled when not transmitting.

The 3PCIOSD1x card provides two methods of enabling/disabling the transmit driver, automatic Send Data (SD) control and Request To Send (RTS) control. With automatic SD control, the driver is enabled when data is sent. The driver remains enabled for the transmission time and ten data bits after data transfer is complete. The SD circuit automatically adjusts its timing to the baud rate of the data. With RTS control, software must assert the RTS line to enable the driver and de-assert to disable the driver. To select SD control for the port, place JP1 jumper in the "Send Data" (left) position. Place this jumper in the "RTS(232)" (right) position for RTS control.

The receiver can also be enabled and disabled, a useful feature in two-wire communications to prevent the transmitted data from "echoing back" on its own receiver. The second jumper "RX" of JP4 determines the receiver mode. When the jumpers are placed in the "485" position, the "echo" is turned off. This is achieved by disabling the receiver when the transmit driver is enabled. Placing this jumper in the "422" position will hold the receiver enabled at all times. *More information on RS-422 communications can be found in B&B's free RS-422/485 Application Note (available on our websites).*

### RS-422 and RS-485 Termination

A 120 $\Omega$  termination resistor has been provided for the RS-422/485 receiver. Note that termination should only be used in systems with both high baud rates (>19200) and over several thousand feet of cable. If a value other than 120  $\Omega$  is desired, space for a through-hole resistor has been provided on the board adjacent to the surface mount termination resistor. This through-hole termination resistor is labeled as RTAB while the surface mount termination resistor is labeled as RTAA. See B&B's free **RS-422/485 Application Note**, *Termination section, page 16, for more information (available on our websites).*

### RS-485 Network Biasing

Biasing is required on an RS-485 network to hold the network in the marking state between transmissions. The 3PCIOSD1x RS-485 receiver is biased with a 4.7 K $\Omega$  pull-up resistor (R28A) on the Receive Data B line and a 4.7 K $\Omega$  pull-down resistor (R29A) on the Receive Data A line. These values are usually adequate for networks without termination and small numbers of nodes. For more complex networks, the user must calculate the required value and replace these resistors. Space for through-hole resistors has been provided over the top of the surface mount components placed at the factory. The through-hole resistor for the pull-up is marked as R28B and the pull-down is marked as R29B.

### 4 X Baud Rate Option

Baud rates higher than 115,200 are possible with the 3PCIOSD1x card in RS-232, 422, or 485 mode. Jumper JP3 controls the clock frequency supplied to the UART. By moving this jumper to the "4" (left) position, the clock frequency is increased from 1.8432 to 7.3728 MHz. This multiplies all UART baud rates by 4 times. For example, if the software is set for 57.6K baud, the actual baud rate will be increased by a factor of four to 230.4K baud. In many systems, these higher baud rates can improve throughput significantly. However, remember that baud rates and actual throughput are only proportional if the system can keep up with the communications, otherwise increasing the baud rate effectively only increases the idle time between characters.

### Installing the Card

1. Ground yourself by touching the metal chassis of the computer to discharge any static electricity.
2. Turn the power to your computer off and unplug the power cord.
3. Remove the cover of the computer.
4. Locate a free PCI expansion slot.
5. Remove the expansion slot cover. Save the screw for installation of the 3PCIOSD1x card.
6. Install the card into the unused slot. Be certain that the card is inserted completely (fully seated) in the slot.
7. Secure the card with the mounting screw from step 5.
8. Replace the cover, plug in the power cord, and power up the system.



## Chapter 3: WINDOWS INSTALLATION

### Windows 95 and Windows 98

Any prior installation using previous B&B serial drivers must be removed before installing the new drivers. (Refer to page 20.)

Windows 98 screens are shown for this section. Windows 95 is a bit different with fewer steps and the screen names and text shown differs. Windows 95 differences are noted (*W95:...*)

1. Configure the port on the PCI card to the desired RS-232/422/485 mode using the jumpers.
2. Install the card in the slot. Start the computer.
3. Windows will detect the PCI card, start the Add New Hardware Wizard, and begin driver installation. When installation is complete, Windows will set the hardware addressing & interrupt using the drivers and the Plug and Play function of the Operating System.
4. The driver installation proceeds in two parts. The first part installs the driver for the PCI Serial card. The second part installs the serial driver for the Com Port A (Port A=Port 1).

NOTE: The Optically Isolated 3PCIOSD1 PCI Serial Adapter card will be identified as the 3PCISD1 PCI Serial Adapter, both cards use the same drivers and are functionally the same to the Operating System.

5. After new hardware is detected, this screen will appear. (*W95: This screen is named Update Device Driver Wizard*).



6. Click **Next** to continue. (*W95: Insert the Driver Disk in Drive, then click Next - skip to step 9*)



7. Click **Next**.



8. Select **Floppy disk drives**, Specify **A:\**

9. Insert the driver disk, then Click **Next**.

Windows will find “PCI Serial Adapter (3PCISD1)” and the driver in file. (W95: Driver name not shown - skip to step 11)



10. Click **Next**.



11. Click **Finish** to begin the second part of the driver installation which installs the Com port driver for Port A.



12. Click **Next**. (W95: Skip to step 15)



13. Click **Next** to continue. Re-insert the driver disk if needed.

Windows will find the Communications Port and inf file.



14. Click **Next**. (W95: Driver name not shown)



15. Click **Finish** to complete Com driver installation.

The computer will finish Com driver installation for Port A.

16. Wait for the process to complete.

To verify the installation, open **My Computer, Control Panel, System** (or Start, Setting, Control Panel, System).

Then select the **Device Manager** Tab.

*continued next page*

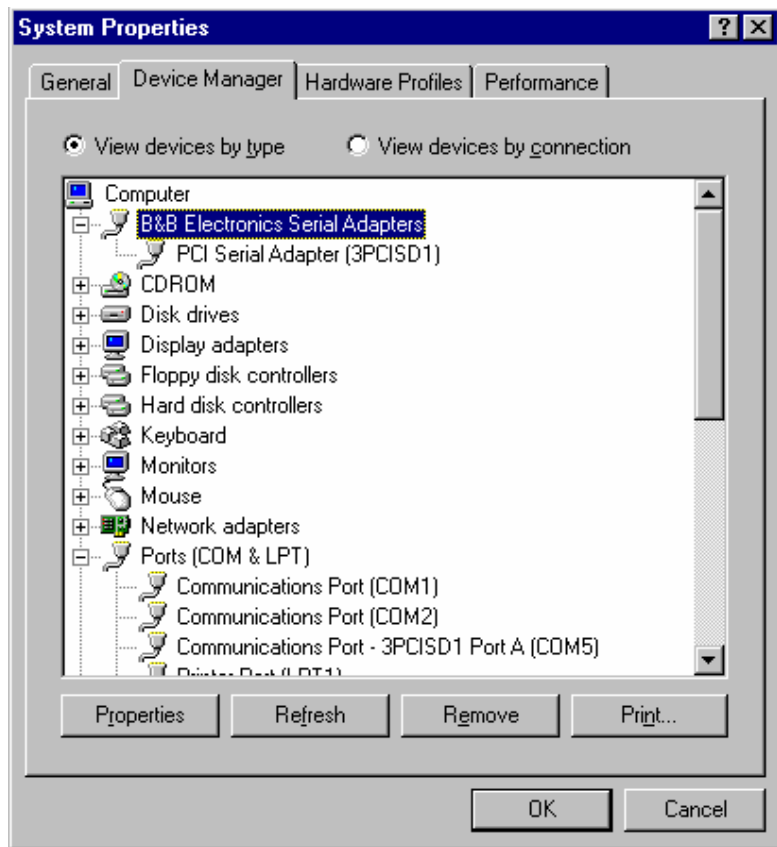

Click the **B&B Electronics Serial Adapters** device to view the adapter. If you want other details, Select **Properties**.

Click **Ports (COM & LPT)** to view the COM numbers assigned by Windows to the card.

The 3PCIOSD1x card will have 3PCISD1 Port A (COMx). The COM port number will normally be COM5, if available.

17. You can now remove the driver disk, close the Windows, and check the new ports with your software.

If your software requires accessing a COM port below COM5, and you have unused COM numbers not occupied by a FAX/Modem or other device, you can re-assign the PCI card COM numbers using our B&B PnP COM Rename utility. Refer to Appendix F.

## Removal of Card And Drivers

If you need to remove the card from your system or remove the current driver before installing a possible future driver upgrade:

1. Open **My Computer, Control Panel, System** (or Start, Setting, Control Panel, System).
2. Select the **Device Manager** Tab (see figure on prior page).
3. Click **B&B Electronics Serial Adapters**, then Select the **PCI Serial Adapter (3PCISD1)** for the 3PCIOSD1x.
4. Click the **Remove** button.
5. Close the Windows, and Open **My Computer, Drive C:**

Open the Windows directory on your Hard Drive, then Open the Inf folder, then Other. (If the Inf folder is not shown, it is hidden. Select **View, Folder Options, Files and Folders, Show all files**. For *Win95: Select **View, Options, View, Show all files***)

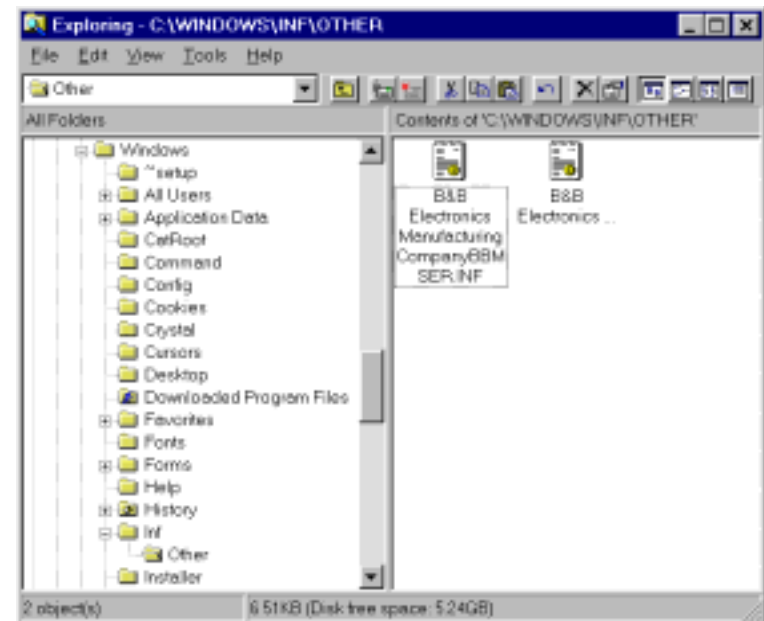

6. Remove the B&B INF files. (\*BBMSER.INF & \*BBMSER95.INF) Close the Window.
7. Shut down the computer, then remove the card.

## Windows 2000 Professional

This section covers device driver installation for Windows 2000 Professional.

1. Configure the port on the PCI card to the desired RS-232/422/485 mode using the jumpers.
2. Install the card in the slot, start the computer as an Administrator or ask your system administrator to install the software.
3. Windows will detect the PCI card and start Found New Hardware Wizard to begin driver installation. When installation is complete, Windows will set the hardware addressing & interrupt using the drivers and the Plug and Play function of the Operating System.
4. Installation will install one driver for the PCI Serial card, and a second driver which is used to assign a Com port to the card.



5. Click **Next** to continue.



6. Select Search, Click **Next**.



7. Insert the driver disk in the **Floppy disk** drive A: Click **Next**.



8. Click **Next**.



9. Click **Finish** to complete the Install.

10. Wait for the process to complete.

Check to verify that a new com port was assigned to the card.

NOTE: The 3PCIOSD1 Optically Isolated PCI Serial Adapter card will be identified as the hardware compatible 3PCISD1 PCI Serial Adapter. Both cards use the same drivers and are functionally the same to the Operating System.

9. Open **My Computer, Control Panel, System**, then select the **Hardware** tab on **System Properties**.

10. Select **Device Manager**, then view the device list.

Under B&B Electronics Serial Adapters, the PCI card is installed.

Under Ports, COM3 was assigned to port A in the card.



11. You can now remove the driver disk, close the Windows and check the new Com port with your software.

## Removal of Card & Drivers

If you need to remove the card from your system or remove the current driver before installing a possible future driver upgrade:

1. Click on *3PCISD1 Port A* under **Ports (COM & LPT)** and select Uninstall (right click). (The 3PCIOSD1x identifies as 3PCISD1.)
2. Next Click on *PCI Serial Adapter (3PCISD1)* under **B&B Electronics**. Select **Uninstall**.
3. Remove the two sets of driver files from the Windows INF directory. (These are named by the OS in the sequence of installation. On a clean system they are: Oem0.inf & Oem0.PNF and Oem1.inf & Oem1.PNF. The .inf versions should be verified by opening it with Notepad, then checking that it is a B&B Electronics file. The PNF version is a compiled copy of the same information.)

You can use the **Find, File or Folder** function to search for the text *B&B* within the files.

You may need to set your Views (under My Computer) to show all files and folders if the INF directory and .inf files are not visible.

4. Shut down the system and remove the card.

## Windows NT 4.0

1. Configure the port on the PCI card to the desired RS-232/422/485 mode using the jumpers.
2. Install the card in the slot, start the computer, and log on to Windows NT 4.0 as an Administrator or ask your system administrator to install the software.
3. Open the Control Panel. (Select Start, Settings)



4. Select **Add/Remove Programs**.

*continued next page*

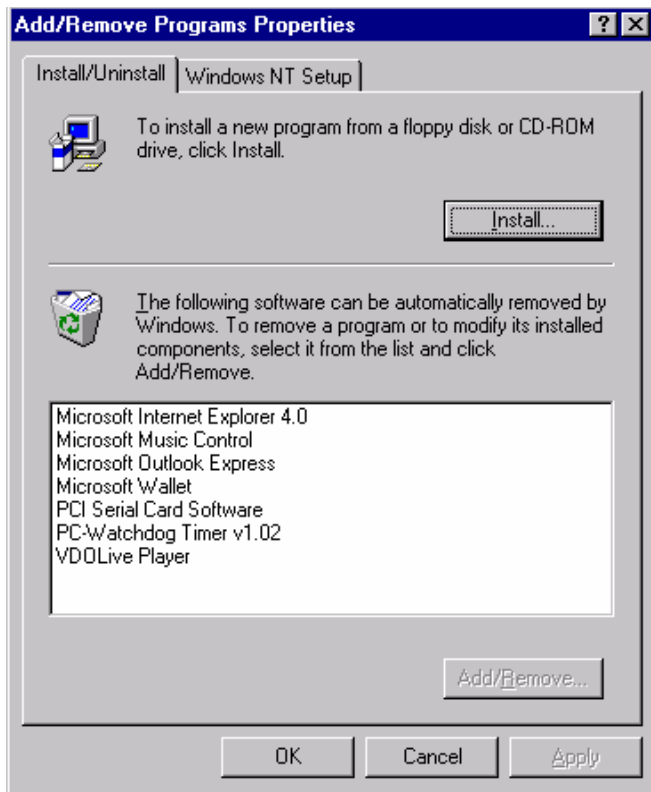

5. Click the **Install** button, then click **Next**.

*continued next page*

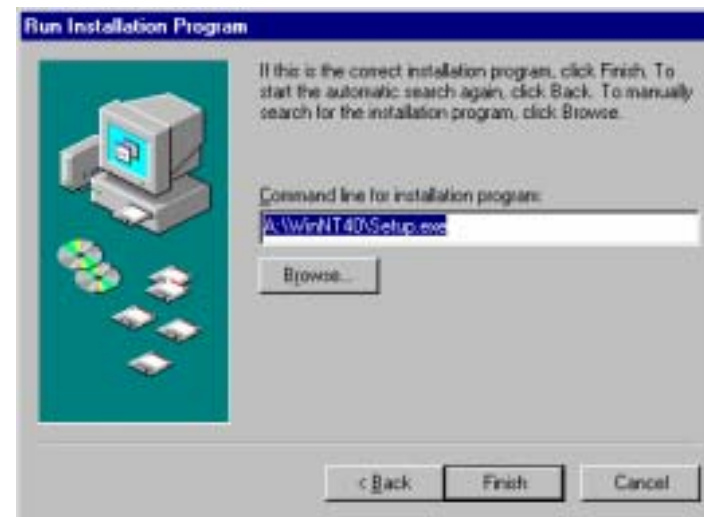

6. Insert the driver disk into drive A:
7. Enter **A:\WinNT40\Setup.exe** in the **Command line for installation program** window. (as above).
8. Click **Finish** to start the Setup program.



9. Click **Next**. Follow the instructions until completed.
10. This driver does not require re-booting to complete installation.
11. Open the **Control Panel**, select **Ports**.



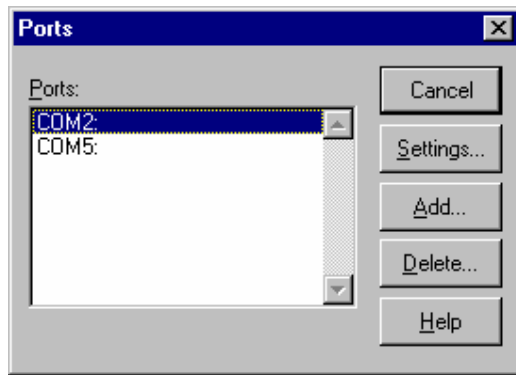

12. Verify 1 new COM Port. (shown here as COM5)

If you have 1 new COM port, the installation is complete. Select the port, select Settings, Advanced. You should obtain the message, "There are no user configurable Advanced I/O parameters for this COM port."

Check the port with your software or with a Loopback test.

NOTE: In the above example, a serial mouse is connected to the port which would usually be COM1. NT does not show it. COM2 is the second built-in serial port.

*continued next page*

You can check details of the serial card setup using **Windows NT Diagnostics**, found under **Administrative Tools**. This can show the **Resources** used such as addresses and IRQ.

Windows Diagnostics will not allow changing anything.

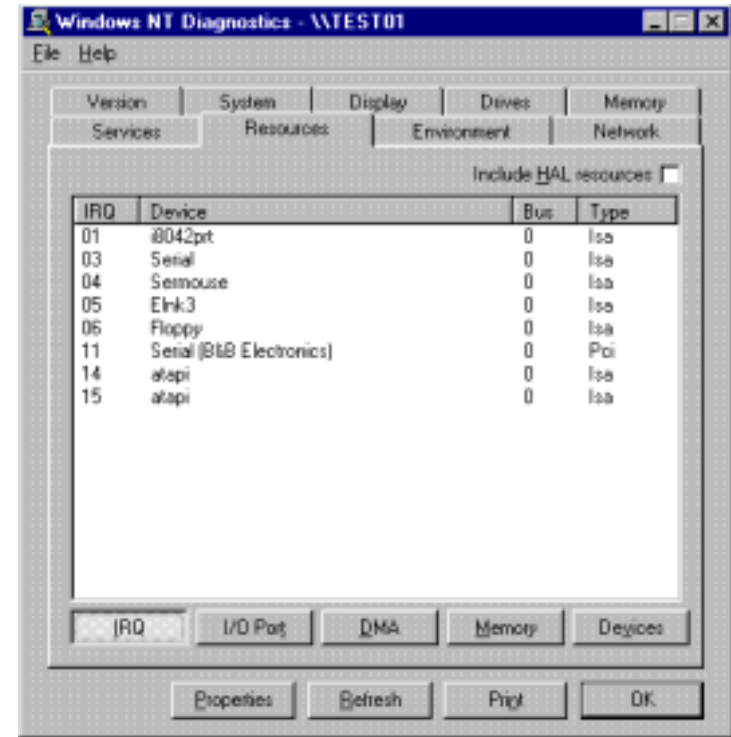

The above shows one port using PCI card interrupt.

*continued next page*

The screen below shows the address range for the serial port on the B&B Electronics 1-port Serial Card.

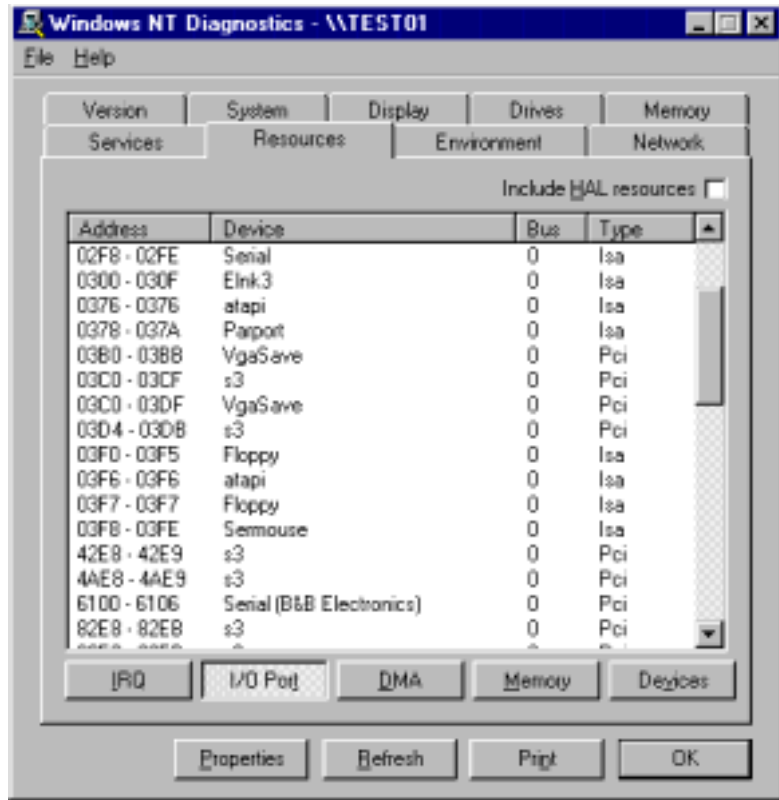

### Removal of Card and Driver

If you need to remove the card from your system or remove the current driver before installing a possible future driver upgrade:

1. Open the Windows NT subdirectory.
2. Open **System32**.
3. Open **Drivers**.
4. Find the "Bbserial.Sys" file and delete it.
5. Shut down the system.
6. Remove the Optically Isolated PCI Serial Adapter card.

*continued next page*

## Chapter 4: TROUBLESHOOTING

If you have any trouble starting your system after installing the card, the card may not be properly seated in the slot. Remove and re-insert it or try a different slot.

If you are unable to communicate with the card using your software and hardware devices:

1. Check your pinouts. In RS-422 or RS-485 mode the "A" lines should match your "A" or "-" lines. "B" lines should match your "B" or "+" lines. *Note: RS-422/485 pinouts are non-standard.*
2. Use the COMTest program provided on the PCI/USB COM Port Utility Disk with a loop back to check the card. Run setup.exe to install COMTest on your program menu under B&B Electronics. A Loopback connection for RS-232 connects the Transmit output to the Receive input. (pins #2 & #3 on the DB25 connector) For RS-422 or 4-wire RS-485, connect the TD(A) to RD(A) and the TD(B) to RD(B). Then use the COMTest program to send characters, and observe the characters being received. To check 2-wire RS-485, you will need to enable the receiver by moving the receive jumper to 422 mode, or use one Port to transmit to another by cross connecting and loading COMTest twice, one copy for each port. Characters typed in one copy of COMTest will appear in the receive window of the other. Note that software must ignore the RS-232 handshaking lines in RS-422/RS485 mode, the input lines (CTS, DSR, DCD, RI) are not pulled high.
3. Try another software package for troubleshooting.
4. Check our website for available FAQ's or troubleshooting hints.
5. Call B&B Electronics Technical Support for troubleshooting assistance.

### USA Office

Technicians are available at (815) 433-5100 to answer your questions from 8 AM - 5 PM weekdays (Central Time).

### European Office

Technicians are available at + 353 91-792444 to answer your questions from 8:30 AM – 5 PM weekdays (GMT Time).

# Appendix A: 3PCIOSD1x I/O SCHEMATIC

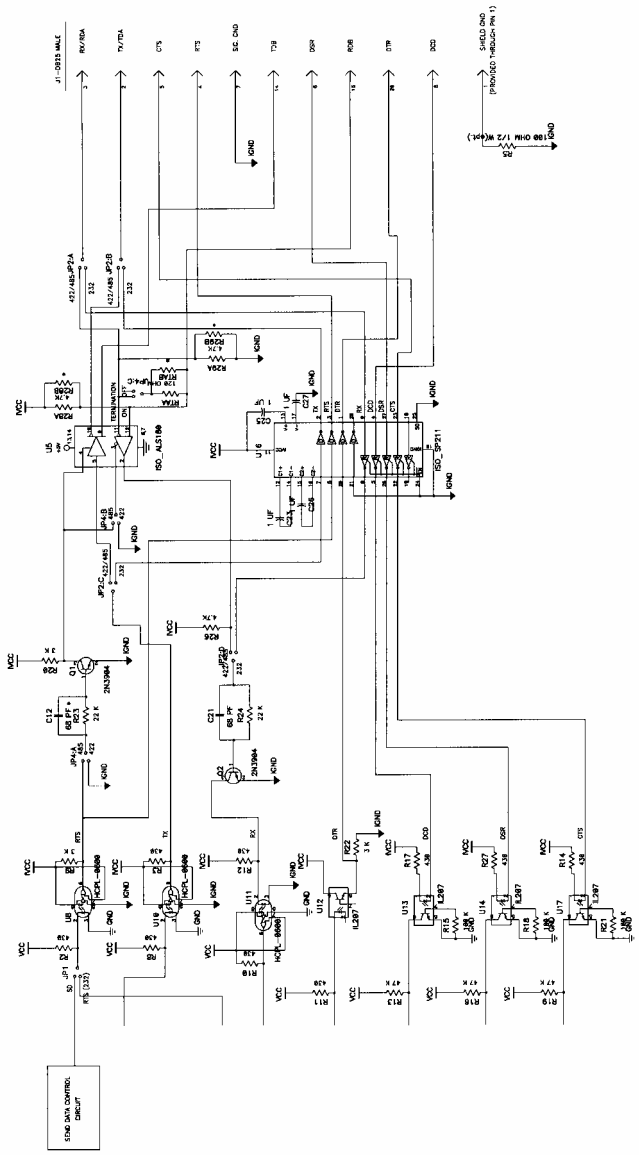

Port 1 I/O Schematic

## Appendix B: RS-232 & RS-422/485 Pinouts

Table 1: RS-232 Pinouts

Name	Description	Direction	DB25M Pin
Shield	Shield	-----	1
TD	Transmit Data	Output	2
RD	Receive Data	Input	3
RTS	Request to Send	Output	4
CTS	Clear to Send	Input	5
DSR	Data Set Ready	Input	6
GND	Signal Ground	-----	7
DCD	Data Carrier Detect	Input	8
DTR	Data Terminal Ready	Output	20

Table 2: RS-422/485 Pinouts

Name	Description	Direction	DB25M Pin
Shield	Shield	-----	1
TD (A) –	Transmit Data A	Output	2
RD (A) –	Receive Data A	Input	3
GND	Signal Ground	-----	7
TD (B) +	Transmit Data B	Output	14
RD (B) +	Receive Data B	Input	16

With 2-wire RS-485 mode operation, your connection cable must jumper TD(A) to RD(A) and TD(B) to RD(B). Connect from TD(A) and TD(B) to the Data A(–) and Data B(+) wires of your RS-485 network.

Note that the EIA RS-422 Specification labels data lines with an "A" and "B" designator. Some RS-422 equipment uses a "–" and "+" designator. In almost all cases, the "A" line is the equivalent of the "–" line and the "B" line is the equivalent of the "+" line. *More information on RS-422 communications can be found in our free RS-422/485 Application Note (available on our websites).*

## Appendix C: Jumper Mode Table

Jumpers Port 1 (A)	RS-232	RS-422 4-Wire	RS-485 4-Wire	RS-485 2-Wire
JP1 Control	RTS(232)	not used	SD/RTS *	SD/RTS *
JP2 A	232	422/485	422/485	422/485
JP2 B	232	422/485	422/485	422/485
JP2 C	232	422/485	422/485	422/485
JP3 D	232	422/485	422/485	422/485
JP4 TX	not used	422	485	485
JP4 RX	not used	422	422	485
JP4 Termination	not used	IN/OUT	IN/OUT	IN/OUT
JP3 Clock	*4/*1	*4/*1	*4/*1	*4/*1

**How to Use the Table:** The left vertical column shows the jumpers for the port. The four right vertical columns show the position setting of the jumper at the left for RS-232, RS-422 or 4-wire RS-485 or 2-wire RS-485 modes.

### NOTES:

RS-485 Mode: The JP1 Control jumper should be set to Send Data mode unless your software requires RTS control.

Refer to the Setup section for explanations of the SD/RTS, Termination and Clock settings.

Note that termination should only be used in systems with both high baud rates (>19200) and over several thousand feet of cable.

*Information on RS-422 and RS-485 communications can be found in the B&B Electronics **RS-422/485 Application Note** (available free on our websites).*

## Appendix D: *TROUBLESHOOTING WITH COMTest*

Included on the PCI/USB COM Port Utility Disk is a test program called COMTest. It can be installed on your "Programs" menu for use by inserting the disk and running Setup.

COMTest is a simple 32-bit Windows (Windows 95, 98, 2000 or NT) COM port Test program. It is a simple tool that can be used to troubleshoot RS-232, RS-422, or RS-485 serial communications. It allows multiple ports, at any address and IRQ, to be opened at any given time. COMTest can also be found on the Internet at the B&B Electronics Mfg. Co. Websites: [www.bb-elec.com](http://www.bb-elec.com) or [www.bb-europe.com](http://www.bb-europe.com).

## Appendix E: ISOLATION AND GROUND

The 3PCIOSD1x provides 2000 VDC minimum isolation on all lines from the DB25 connector to the host computer. The 3PCIOSD1x cards have no connection from pin 1 (chassis ground) to ground of the host computer. This was done to completely isolate the computer end of the communications. In most applications, the shield wire should be connected to ground on only one end of the network. Board space is provided to connect pin 1 to the isolated port ground (pin 7). If you wish to make this connection, it is recommended that a 100 $\Omega$  ½ watt resistor be installed in R5 of the 3PCIOSD1x. The purpose of the resistor is to limit large currents flowing through the ground connection.



## Appendix F: Renaming COM Ports - Win 95/98/ME

### Renaming PCI COM Ports Using the PnP COM Rename Utility

**CAUTION:** You must be using Windows 95/98 or ME. This utility is not designed for NT or other Windows versions.

*This program edits the registry directly, it will only change entries related to B&B PCI or USB Serial Ports. Improper use of this program can cause conflicts with other COM Ports installed on your computer.*

*Renaming COM ports will only affect software that accesses COM ports through Windows, not software that accesses ports from DOS or at the hardware level.*

*This program should only be used after all serial ports have been installed.*

Windows 95/98 and ME automatically assigns COM port numbers starting at COM5 when the port is not at the standard base addresses for COM1 to COM4.

If your software refuses to access COM ports above COM4, and you have unused COM numbers that you want to be able use with your B&B PCI Serial Card, this utility can be used to rename some or all of the ports to the unused COM numbers.

First, check the ports list shown in the Device Manager, then check any Modem or FAX device to make sure that the port number isn't being used for a FAX/Modem or Network Redirector.

If you have built-in ports you want to disable from the BIOS in order to use your PCI card at that COM number, first remove the port with the Device Manager. Then re-boot to the BIOS, disable the port with hardware settings, Exit with a "Save Settings", then re-start Windows Next, verify the port number is not present. Then use the Rename utility to rename the PCI card ports as needed.

To Remove a Port: Choose Settings, Control Panel, System, Device Manager, then select the port to highlight it. Click Remove below the window. To remove all B&B PCI ports, select the B&B Serial Adapter. This clears registry entries for the card and ports.

### Install the PCI/USB COM Port Utilities

- (1) To use the PnP COM Rename utility, insert the PCI/USB COM Port Utility Disk and run Setup.exe. This will install COMTest and PnP COM Rename under Programs, B&B Electronics.
- (2) The Rename utility will not be installed if you are running Windows 2000 or NT.

### Using PnP COM Rename

- (1) Shut down all programs that are accessing any Com ports.
- (2) Start the PnP COM Rename Utility from the Programs menu under B&B Electronics.
- (3) Read the Cautionary Warnings. It is possible to rename a PCI or USB serial port to a number already in use which will cause problems. If any problems occur after renaming, you may need to re-start the system and rerun the Rename utility to correct the situation or remove the serial card in the Device Manager. Then Refresh the Device Manager to detect the card and re-install the drivers. Determine which renamed COM port caused the problem, and do not use that name for a renamed port.
- (4) Accept the conditions of use by clicking Yes or click No to exit.
- (5) Select the currently named COM port number you want to change in the left window, then the new number in the right window. Then click Finish. Repeat for other ports as needed.

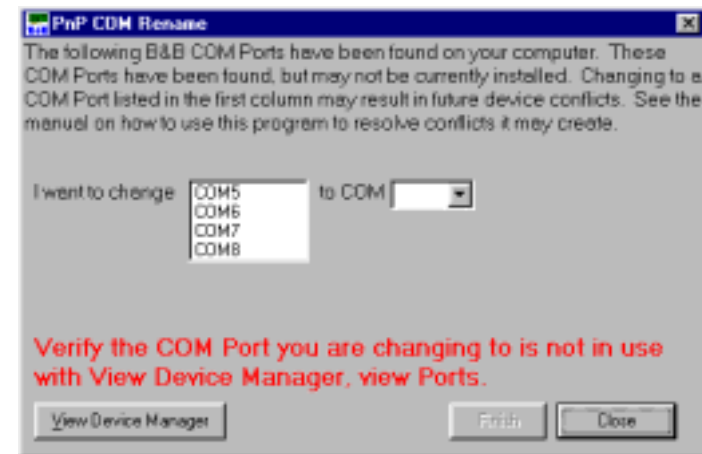



- (6) If the PCI card was previously installed and not removed in the Device Manager, you may find several B&B COM ports with the same number. The last instance of the same number is usually the most recent installation. Only the active ports can be renamed with the program to show the new name under the Device Manager. Inactive port numbers will not show any change after renaming. Ideally, unused entries should be removed by using RegEdit, then having the system re-install the drivers to make the entries. This will result in a single entry for each port on the card, and only that entry will need to be changed.
- (7) After all B&B PCI or USB COM ports have been renumbered as needed, click Close to exit.

If you need to install another serial device after using renaming with this utility, you must:

- (1) Name all COM Ports back to original settings using this program.
- (2) Install the new device according to manufacturer directions.
- (3) Use this utility to rename the B&B COM Ports again as needed.

## Appendix G: DECLARATION OF CONFORMITY

DECLARATION OF CONFORMITY	
Manufacturer's Name:	B&B Electronics Manufacturing Company
Manufacturer's Address:	P.O. Box 1040 707 Dayton Road Ottawa, IL 61350 USA
Model Numbers:	3PCIOSD1a/b
Description:	Optically Isolated Serial PCI Card
Type:	Light industrial equipment
Application of Council Directive:	89/336/EEC
Standards:	EN 55022 EN 61000-6-1 EN 61000 (-4-2, -4-3, -4-4, -4-5, -4-6, -4-8, -4-11)
	
William H. Franklin III, Director of Engineering	